



TI-Nspire™ App for iPad® Guidebook

Learn more about TI Technology through the online help at education.ti.com/eguide.

Important Information

Except as otherwise expressly stated in the License that accompanies a program, Texas Instruments makes no warranty, either express or implied, including but not limited to any implied warranties of merchantability and fitness for a particular purpose, regarding any programs or book materials and makes such materials available solely on an "as-is" basis. In no event shall Texas Instruments be liable to anyone for special, collateral, incidental, or consequential damages in connection with or arising out of the purchase or use of these materials, and the sole and exclusive liability of Texas Instruments, regardless of the form of action, shall not exceed the amount set forth in the license for the program. Moreover, Texas Instruments shall not be liable for any claim of any kind whatsoever against the use of these materials by any other party.

© 2025 Texas Instruments Incorporated

QR Code® is a registered trademark of DENSO WAVE INCORPORATED.

Actual products may vary slightly from provided images.

Contents

Getting Started	1
What You Must Know	1
Using the TI-Nspire™ Home Screen	1
Accessing Settings	2
Managing Documents	3
Using TI-Nspire™ App for iPad® Keyboards	4
Using Custom TI Keyboard for Dialog	5
Resetting TI-Nspire™ Content	5
Working with Documents	7
Exploring the TI-Nspire™ Toolbar	7
Exploring the TI-Nspire™ Page Sorter	8
Using TI-Nspire™ Page Sorter	8
Exploring the Document Work Area	10
Opening a New Document	12
Saving Changes to Documents	12
Adding Pages to Documents	12
Adding Problems to Documents	13
Deleting Pages from Documents	13
Copying and Pasting Pages in Documents	13
Changing Document Settings	14
Sharing Documents	15
Receiving Documents	16
Working with Photos in Documents	17
What You Must Know	17
Taking Photos	17
Adding Existing Photos to Documents	17
Copying and Pasting Photos in the Notes Application	18
Resizing Photos	18
Deleting Photos	18
Capturing Screens	19
Calculator Application	20
What You Must Know	20
Adding a Calculator Page	21
Entering Simple Math Expressions	22
Inserting Symbols, Functions, Commands, and Templates	23
Using Wizards	24
Using an Expression Template	25
Using the Unit Conversion Assistant	26
Conversion Categories	28
Variables Overview	29
Defining Variables	29

Naming Variables and Functions	30
Creating Variables in Calculator	31
Creating Variables in Graphs	32
Creating a Variable from a Geometry Value	32
Creating Variables in Lists & Spreadsheet	33
Adjusting Variable Values with a Slider	35
Linking a Lists & Spreadsheet Cell or Column to a Variable	37
Locking and Unlocking Variables	39
Graphs Application	41
What You Must Know	41
Adding a Graphs Page	43
Graphing Functions	44
Exploring Graphs with Path Plot	45
Graphing Linear and Conic Equations	46
Graphing Relations	47
Graphing Parametric Equations	49
Graphing Polar Equations	50
Using the Text Tool to Graph Equations	51
Graphing a Scatter Plot	52
Plotting Sequences	52
Graphing Differential Equations	54
Viewing Tables in the Graphs Application	56
Accessing the Graph History	57
Customizing the Graphs Work Area	57
Tracing Graphs or Plots	60
Introduction to Geometric Objects	60
Creating Geometric Objects	62
Measuring and Transforming Geometric Objects	63
Exploring with Construction Tools	64
Labeling (Identifying) the Coordinates of a Point	66
Bounded Area (Area Between Curves)	67
Displaying the Equation of a Geometric Object	69
Using the Calculate Tool	70
Creating Shapes Using Gestures (MathDraw)	71
Sticky Tool in Geometry and Graphing	73
3D Graphing	75
Selecting the 3D Graphing View	75
Graphing 3D Functions	76
Graphing 3D Parametric Equations	77
Zooming and Rotating the 3D View	78
Editing a 3D Graph	78
Changing the Appearance of a 3D Graph	79
Showing and Hiding 3D Graphs	79
Customizing the 3D Viewing Environment	80

Geometry Application	82
What You Must Know	82
Adding a Geometry Page	84
Introduction to Geometric Objects	85
Creating Geometric Objects	86
Measuring and Transforming Geometric Objects	87
Exploring with Construction Tools	88
Using the Calculate Tool	91
Creating Shapes Using Gestures (MathDraw)	91
Sticky Tool in Geometry and Graphing	94
Lists & Spreadsheet Application	96
What You Must Know	96
Adding a Lists & Spreadsheet Page	97
Working with Data	97
Graphing Spreadsheet Data	99
Statistical Calculations and Results	100
Distributions	101
Working with Tables	108
Manual Data Capture	108
Data & Statistics Application	111
What You Must Know	111
Adding a Data & Statistics Page	112
Working with Plots	114
Working with Charts	117
Adding Color to Plots and Charts	118
Notes Application	119
What You Must Know	119
Inserting Comments, Shapes, and Calculations	121
Working with Math Boxes	123
Inserting Chemical Equations	124
Using Math Actions	124
Graphing from Notes and Calculator	127
Using a Displayed QR Code®	129
Question Documents Overview	132
What You Must Know	132
Responding to Questions	133
Showing Your Work, Checking Answers, and Clearing Answers	137
Submitting Responses	138
Widgets	139
Creating a Widget	139
Adding a Widget to a Document	139
Saving a Widget	139

Libraries Overview	140
What You Must Know	140
Creating Library Documents	141
Adding Objects to a Library Document	141
Private and Public Library Objects	142
Accessing Library Objects	143
Refreshing Libraries	144
Program Editor Overview	145
What You Must Know	145
Accessing the Program Editor	146
Defining a New Program or Function	146
Entering Lines into a Function or Program	147
Checking Syntax	148
Storing a Function or Program	148
Running Programs and Evaluating Functions	149
Opening Functions or Programs for Editing	150
Importing Programs	151
Using Test Mode	153
Preparing the iPad® for Test Mode	153
Entering Test Mode by Choosing Restrictions	153
Entering Test Mode with a Test Code	155
Reviewing Test Mode Restrictions	158
Working with a Document in Test Mode	159
Exiting Test Mode	160
Understanding Test Mode Restrictions	161
General Information	165
Index	166

Getting Started

The TI-Nspire™ App for iPad® enables you to use the TI-Nspire™ Student Software or TI-Nspire™ CAS Student Software on an iPad®.

What You Can Do

You can use the TI-Nspire™ App for iPad® and TI-Nspire™ CAS App for iPad® to:

- Perform calculations
- Work with variables
- Import images (photos)
- Respond to questions
- Perform graphing and geometry functions
- Create lists and spreadsheets
- Analyze data

What You Must Know

Initial Launch

When you open the TI-Nspire™ App for iPad® for the first time after installation, you will be prompted to allow access to your photos for saving screenshots and inserting photos.

If you choose **Select Photos**, only those photos you select in your Photos library can be inserted into a document. Selecting **Allow Access to All Photos** is recommended if you have a large number photos on your iPad®.

Accessing Online Help

The TI-Nspire™ App for iPad® includes online help, which opens in the Safari browser.

- ▶ To access the online help from within the app, tap **Help ?**, and then tap **Online Help**.

Using the TI-Nspire™ Home Screen

When the app is first installed, a TI-Nspire or TI-Nspire CAS folder is created in the **On My iPad** location. It contains four pre-loaded folders (Math, MyLib, MyWidgets, and Simulations), and three Getting Started documents: Getting Started with the TI-Nspire™ App, Getting Started with Data and Statistics, and Getting Started with Graphs.

The Home screen uses much of the same functionality as the iPad® Files app such as Recents, Locations, Tags, and file/folder management. Recommended locations to store .tns files are On My iPad and iCloud Drive.

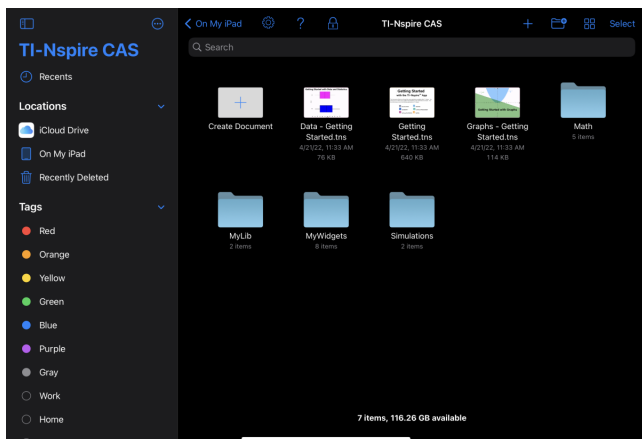

Note: TI-Nspire™ App for iPad® supports only .tns documents.

To return to the TI-Nspire™ Home screen from any other screen within the application, tap < **Home**.

iPadOS® Settings

To ensure the best possible experience when using the TI-Nspire™ App for iPad®, it is strongly recommended that you select the **Full Screen Apps** mode in the iPadOS® **Multitasking & Gestures** settings. Other modes may cause unexpected behavior especially when the app window is resized to something smaller than full screen.

Accessing Settings

1. From the TI-Nspire™ Home screen, tap **Settings** .

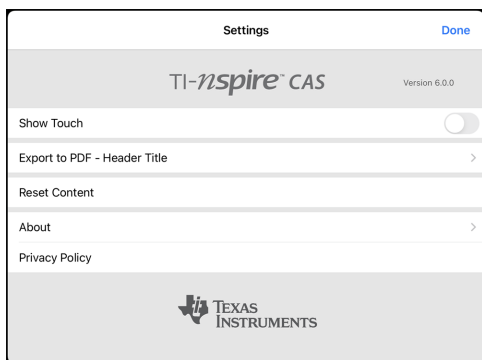

2. Tap the option names to:
 - **Show Touch.** Select to show or hide touches to the screen.
 - **Export to PDF - Header Title.** Change the default title for exported PDFs.

- **Reset Content.** Deletes all user-created TI-Nspire™ documents and folders, clears the Clipboard, and restores the factory default documents. **Warning: You cannot undo this action.** For details, refer to [Resetting TI-Nspire™ Content](#).
- **About.** Read information about the app, and check the version of the app.
- **Privacy Policy.** Open the Texas Instruments Online Privacy Policy.

3. Tap **Done** to return to the TI-Nspire™ Home screen.

Managing Documents

Opening a Document

► Tap the document icon.

The document opens on the first page.

Adding New Documents

1. Tap **New** + in the toolbar or tap the **Create Document** icon if displayed (folder view).

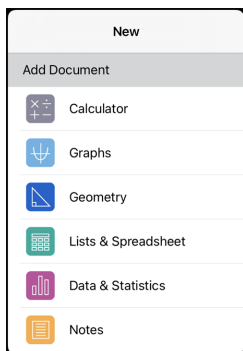

2. Tap an application name.

A new document opens with the selected application as the first page. The new document is assigned a default name.

Renaming Documents

1. Tap the default name under the document to open the keyboard.
2. Type a new name, and then tap **done**.

The new name is displayed and the keyboard closes.



Using Custom TI Keyboard for Dialog

Every dialog inside the application has a custom keyboard available.

Example:

Go to **Graphs > Tools > Window/Zoom > Window Settings**.

The **Window Settings** dialog appears.

Cancel	Window Settings	OK
XMin:	<input type="text" value="-10"/>	
XMax:	<input type="text" value="10"/>	
XScale:	<input type="text" value="Auto"/>	>
YMin:	<input type="text" value="-6.8027888446215"/>	
YMax:	<input type="text" value="6.8027888446215"/>	
YScale:	<input type="text" value="Auto"/>	>

Tap in any field.

The custom keyboard for dialog is available.



Note: The following keys are not available.

- Chem Box
- Math box
- Variable Keys
- Arrow Up
- Arrow Down

Resetting TI-Nspire™ Content

WARNING: You cannot undo this action.

Resetting Content does the following:

- Permanently deletes all user-created content from the app folder in the On My iPad location.
- Restores the factory pre-loaded documents and MyLib folder.
- Clears the Clipboard to prevent the pasting of unauthorized information.

To Reset Content:

1. From the TI-Nspire™ Home screen, tap **Settings** .

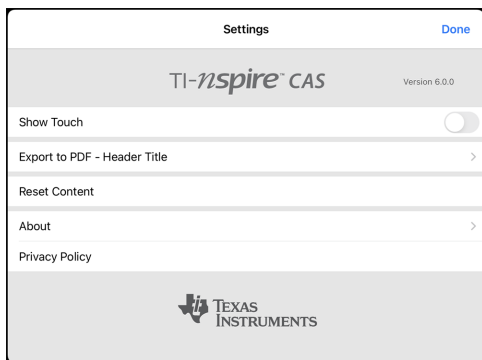

2. Tap **Reset Content**.

An alert message appears.

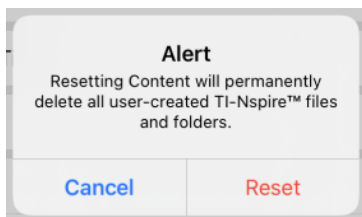

3. To proceed with the reset, tap **Reset**.

After the reset is complete, the TI-Nspire™ Home Screen reappears.

Working with Documents

All work created using TI-Nspire™ applications is stored in a TI-Nspire™ document (.tns file), which you can share with others.

A document consists of one or more problems and each problem contains one or more pages. A single page is displayed in the work area. All work occurs in the applications within pages.

When you add a new document, the selected application is the first page of the document.

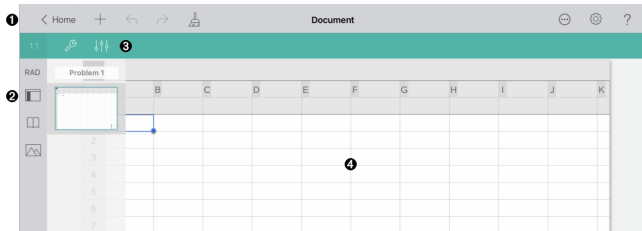



- 1 The TI-Nspire™ Toolbar.
- 2 Page Sorter.
- 3 Document toolbar.
- 4 Document work area. This example shows the Lists & Spreadsheet work area.

Exploring the TI-Nspire™ Toolbar

The TI-Nspire™ Toolbar contains tools available for use in open documents.





	Home. Return to the TI-Nspire™ Home screen.
	Add. Add a new page or problem to a document.
	Undo. Undo the previous action.
	Redo. Redo the last action.
	Clear Document Contents. Clears all problems and apps from document.
Document	Document Name. The name of the active document.
	More. Exports all viewable problems and pages in the active document

	to a PDF using the Export to PDF option. (see Sharing Documents for more information)
	Settings. Apply document settings for the active document or to all documents.
	Help. Access Online Help or the PDF Guidebook.

Exploring the TI-Nspire™ Page Sorter

The TI-Nspire™ Page Sorter contains tools available for use in open documents.

RAD	Angle Mode. Shows an abbreviation of the angle mode (degrees, radians, or gradients) in effect.
	PageSort. Hide or show the Page Sorter.
	Utilities. Access utilities for the active application (symbols, catalog, etc.).
	<p>Insert Photo. Send the current page to the iPad® Photos app, take a photo, add an existing photo in a document, scan a QR Code®.</p> <p>Note: You can insert photos in the Graphs, Geometry, Data & Statistics, and Notes applications. Scanning a QR Code® is only available in the Notes application.</p>

Using TI-Nspire™ Page Sorter

The TI-Nspire™ Page Sorter contains tools available for use in open documents.

Hide or Show Pages

To show or hide pages in an open document:

1. Tap the Page Sorter icon  to show pages.

Note: All pages in the document will slide open from the right.

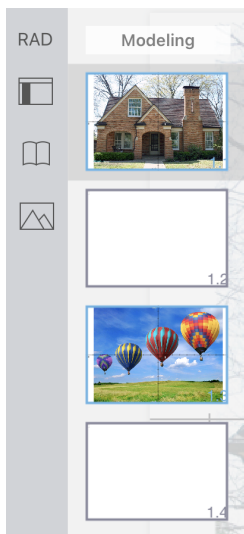

2. Tap the Page Sorter icon  or anywhere on the screen to hide the pages.

Move a Page

- ▶ Press and hold a page to move to a different position.

Page Options

- ▶ Double tap on a page to see available options.
 - Cut
 - Copy
 - Delete

Hide or Show Problem

1. Tap once on the problem name to show all pages.
2. Tap once on the problem name to hide all pages.

Rename a Problem

1. Tap twice on the problem name.

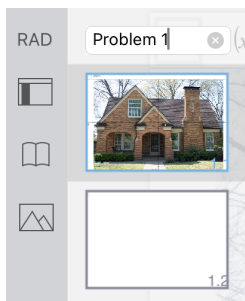

2. The keyboard appears.
3. Type the new problem name.

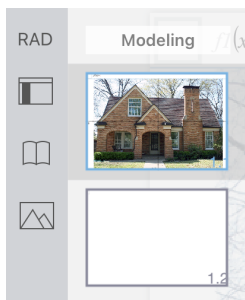

4. Tap on the dismiss key  to hide (or dismiss) the keyboard.

Exploring the Document Work Area

The document work area consists of the application toolbar, the open document, and the page sorter.

From open documents on the work area, you can add, delete, and rearrange pages in documents, and you can rename problems.

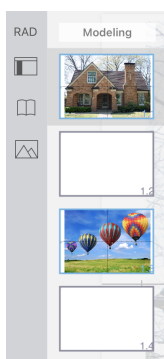
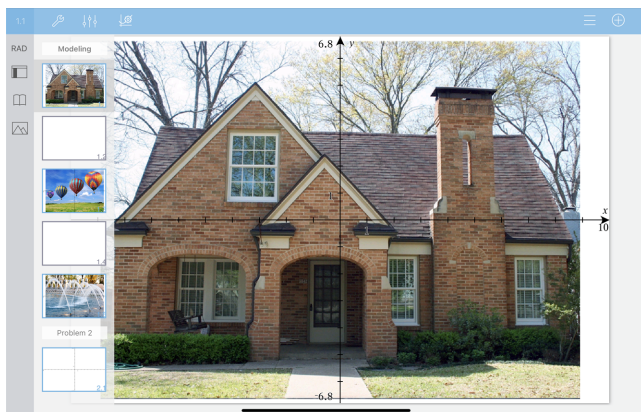





Page Sorter. Displays thumbnail sketches of all pages in all problems in the current document. Swipe up or down to view pages off the screen.

Application. The document toolbar color indicates which application is active in the work area.

1.1		Calculator
1.1		Graphs
1.1		Geometry
1.1		Lists & Spreadsheet
1.1		Data & Statistics
1.1		Notes

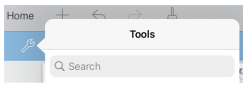
1.2

Problem/Page Number. Displays the problem number followed by the page number.

	<p>Tools. Opens the tools menu for the active application.</p>  <p>Tools Search allows you to search options and menus. It is available across all applications in the TI-Nspire™ App.</p> <p>Warning: Tools Search will allow you to search for menu items, but not for command names.</p>
	<p>Inspector. Tap to change the properties of a selected item.</p>
	<p>Settings. Tap to change the Graphs & Geometry settings.</p>
	<p>History. In the Graphs application, shows the history of the defined functions.</p>
	<p>Show/Hide. In the Graphs application, shows or hides the keyboard.</p>

Opening a New Document

1. On the TI-Nspire™ Home screen, tap **New** + .

The **New** menu opens.

2. Tap an application name.

A new document opens with the selected application as the first page. The new document is assigned a default name.

Saving Changes to Documents

When you tap < **Home** from an active document, the TI-Nspire™ App automatically saves the document even if no changes were made.

WARNING: You cannot undo any changes to a document once you navigate to the Home screen.

Note: If you added a new document but did not rename it before adding pages, it will save with the default name ("Document"). You can then rename the document on the Home screen as needed.

Adding Pages to Documents

1. In the page sorter, tap the page in the problem where you want to add another page.
2. Tap **New Page** + .

The New Page menu opens.

3. Tap the type of application you want to add to the document.

A new page is added to the document beneath the current page.

Note: To move a page, touch and hold the page, and then drag it to another position.

Adding Problems to Documents

1. From an active document, tap **New Page** + .

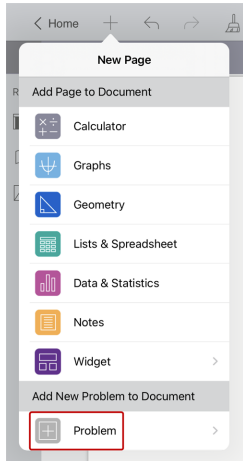

2. Tap **Problem**.
3. Tap the type of problem you want to add to the document.

A new problem is added beneath the current problem in the page sorter.

Note: To rename the problem, double-tap the problem name, type the new name, and then tap **return**.

Deleting Pages from Documents

1. Tap  to open the page sorter.
2. Double-tap the page you want to delete to open the context menu.
3. Tap **Delete**.

Copying and Pasting Pages in Documents

You can cut, copy, and paste pages from documents to other places in the active document or in another document.

Copying or Cutting Pages

1. Tap  to open the page sorter.
2. Double-tap the page you want to cut or copy to open the context menu.

3. Tap **Cut** or **Copy**.

Pasting Pages to Another Location

1. Double-tap the page in the page sorter where you want to paste to open the context menu.
2. Tap **Paste**.

The page is pasted beneath the selected page in the problem.

Changing Document Settings

Document settings control how all numbers, including elements or matrices and lists, are displayed in TI-Nspire™ documents. You can change the default settings at any time, and you can specify settings for a specific document.

Complete the following steps to customize the settings that are applied to your document.

1. Create a new document or open an existing document.
2. Tap **Settings** .

When you open Document Settings the first time, the default settings are displayed.

3. Tap the menu name to open the menu and view the available values for each setting.

Field	Value
Display Digits	<ul style="list-style-type: none">• Float• Float1 - Float12• Fix0 - Fix12
Angle	<ul style="list-style-type: none">• Radian• Degree• Gradian
Exponential Format	<ul style="list-style-type: none">• Normal• Scientific• Engineering
Real or Complex Format	<ul style="list-style-type: none">• Real• Rectangular• Polar
Calculation Mode	<ul style="list-style-type: none">• Auto• Exact• Approximate

Field	Value
	Note: Auto mode shows an answer that is not a whole number as a fraction except when a decimal is used in the problem. Exact mode (CAS) shows an answer that is not a whole number as a fraction or in symbolic form, except when a decimal is used in the problem.
CAS Mode	<ul style="list-style-type: none"> • On • Exact Arithmetic • Off Note: This option is only available on CAS software.
Vector Format	<ul style="list-style-type: none"> • Rectangular • Cylindrical • Spherical
Base	<ul style="list-style-type: none"> • Decimal • Hex • Binary
Unit System (CAS)	<ul style="list-style-type: none"> • SI • Eng/US Note: This option is only available on CAS handhelds and software.

4. Select the desired settings.
5. Choose one of the following options:
 - To apply the customized settings to ALL documents, tap **Make Default**.
 - To apply the settings to the open document only, tap **Done**.
 - To restore default settings, tap **Restore**.

Sharing Documents

Sharing a Document from the Home Screen

To share a document from the Home screen:

1. Tap the document and hold until the context menu displays.
2. Tap **Share** .
3. Tap the icon of the app or location where you want to share the .tns file.

Exporting a Document as a PDF

To export a document as a PDF from within the document:

1. Tap **More** .

2. Tap **Export to PDF**.

The app opens a screen showing the PDF.

3. Tap **Share** .

4. Tap the icon of the app or location where you want to share the PDF.

Receiving Documents

If you have an email account set up on your iPad®, you can receive documents that the teacher sends, work on those documents, and send them back to the teacher.

To receive a document by email:

1. Tap the icon of the attached document in the email.

2. Tap **Save to Files** .

3. Choose the preferred location on your iPad® to save the document (On My iPad, iCloud Drive, etc.).

4. Tap **Save**.

Working with Photos in Documents

Photos can be used in the TI-Nspire™ App for iPad® for reference, assessment, and instructional purposes.

What You Can Do

Add photos to the following TI-Nspire™ applications:

- Graphs
- Geometry
- Data & Statistics
- Notes

What You Must Know

- In the Graphs, Geometry, and Data & Statistics applications, photos are set in the background behind the axis and other objects. In the Notes application, the photo is set at the cursor location inline with the text (in the foreground).
- You can take a photo and add it to your document, or you can use a photo that is already stored in the photo albums. The TI-Nspire™ software automatically creates a photo album named **TI-Nspire™ Photos HD** and stores it in the iPad® photo albums. You can also use other photo albums that you create on the iPad®.

Taking Photos

1. Open the document to the page where you want to add a photo.
2. Tap **Insert Photo** .
3. Tap **Take Photo**.
4. Aim the iPad® viewfinder at the object you want to capture.

When you take the photo, a preview is displayed.

- To discard the photo and take a different one, tap **Retake**.
- To insert the photo in the document, tap **Use Photo**.

The photo is inserted into the active document and added to the **TI-Nspire™ Photos HD** album.

Adding Existing Photos to Documents

1. Open the document to the page where you want to add a photo.

If you are working in a Notes page, the photo will be inserted where the cursor is located.

2. Tap **Insert Photo** .
3. Tap **Add Photo**.
4. Tap the album where the photo resides.

5. Tap a thumbnail of the photo you want to insert.

The photo is inserted into the active document.

More Information

Adding photos will depend on the current level of access you have selected in the iPad® settings:

- **Selected Photos** - Allows access to photos that were previously selected (see section below).
- **All Photos** - Allows access to all photos on your iPad®.
- **None** - The **Add Photo** option will not be available.

Selected Photos

- If you tap a photo that was not selected previously, a prompt will appear with **Select More Photos** and **Keep Current Selection**. This prompt only appears on the first attempt to add a photo after the option has been selected in the iPad® settings.
- You can see which photos have already been selected with the **Select More Photos** from the example mentioned above, or by going to **TI-Nspire CAS > Photos > Selected Photos** in the iPad® settings. Those photos will have a blue checkmark .

Copying and Pasting Photos in the Notes Application

You can copy and paste photos in the Notes application.

- ▶ To copy a photo, tap the photo to select it, tap it again to open the context menu, and then tap **Copy**.
- ▶ To paste a photo, double-tap the area in the document where you want to insert the photo, and then tap **Paste**.

Resizing Photos

You can resize photos in all applications that use photos.

1. Select the photo.
 - In the Graphs, Geometry, and Data & Statistics applications, tap the Tools icon  and go to **Actions > Select Photo**.
 - In the Notes application, tap the photo to select it.
2. Drag a corner of the photo to resize it.

Deleting Photos

You can delete photos from within the open document.

1. Select the photo.
 - In the Graphs, Geometry, and Data & Statistics applications, tap **Tools**  and go to **Actions > Select Photo**.
 - In the Notes application, tap the photo to select it.

2. Tap the photo to open the context menu.
3. Tap **Delete**.

Capturing Screens

You can capture a page instead of the whole App screen.

1. Tap **Insert Photo** .
2. Tap **Send Page to Photos**.

The screen will turn white for a second.

The image is saved to the Library in Photos.

Calculator Application

The Calculator application enables you to enter and evaluate math expressions. You can define variables, functions, and programs in Calculator. When you define or edit a variable, function, or program, it becomes available to other applications—such as Graphs or Geometry—that are part of the same problem.

What You Can Do

The Calculator **Tools**  menu provides the tools you need to:

- Complete actions.
- Work with numbers.
- Work with math functions such as algebraic expressions, calculus problems, probability, and statistics.
- Work with matrices and vectors.
- Create and solve financial equations.
- Define and edit functions, variables, and programs.

Tools Search

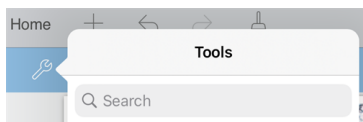

Tools Search allows you to search options and menus. It is available across all applications in the TI-Nspire™ App.

Warning: Tools Search will allow you to search for menu items, but not for command names.

What You Must Know

Deferring Evaluation

You don't have to complete and evaluate an expression as soon as you enter it. You can enter part of an expression, leave the page to check work on another page, and then come back to the page to complete the expression at a later time.

Forcing a Decimal Approximation

To force a decimal approximation in a result, complete one of the following actions:

- ▶ Touch and hold **enter**, and then slide to select  to evaluate the expression.
- ▶ Include a decimal in the expression.
- ▶ Wrap the expression in the **approx()** function.

Accessing Calculator History Items

You cannot edit an expression if the result has been calculated. However, you can copy the expression from the history and paste it into the entry line.

Copying History Items

1. Drag the work area up or down to find the expression or result you want to copy.
2. Tap the expression to select it and open the context menu.
3. Tap **Paste History** to copy the expression into the active entry line.

Copying Part of an Expression

1. Tap the expression to select it.
2. Drag the handles to highlight the part of the expression you want to copy.
3. Tap **Paste History** or tap **enter** to copy the selected item to the active entry line.

Clearing Calculator History

When you clear the history, all variables and functions defined in the history retain their current values. To clear all items in the Calculator history:

1. Tap **Tools**  and go to **Actions**.
2. Tap **Clear History** to remove all expressions and results from the history.

Note: If you clear the history by mistake, tap  to restore the history items.

Adding a Calculator Page

To open a new document or add a page to an existing document with the Calculator application active:

1. From the TI-Nspire™ Toolbar, tap **+**.
 - If this is a new document, the **New** menu opens.
 - If adding a page to an existing document, the **New Page** menu opens.
2. Tap **Calculator** .

The Calculator application is added to the document. By default, the TI-Nspire™ Keyboard is shown and the cursor is in the entry line.

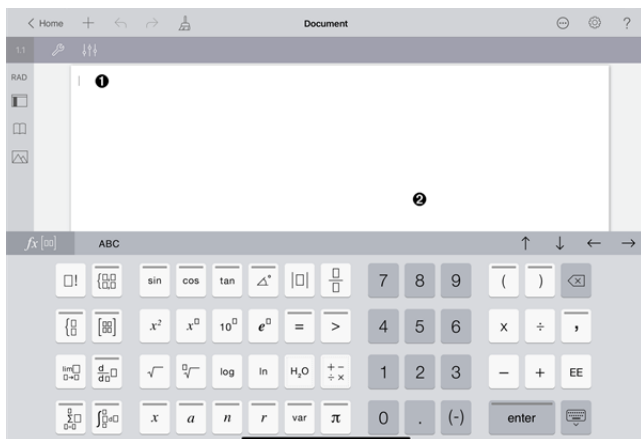

- 1 **Entry line.** Type or insert a math expression in the entry line. Tap **enter** to evaluate the expression.

$$\frac{2^8 \cdot 43}{12} \qquad \frac{2752}{3}$$

You can also insert functions, symbols, templates, or expressions from Utilities .



Note: If the keyboard is hidden, tap the entry line to show it.

- 2 **Calculator work area.** As you evaluate expressions, both the expression and result are saved in Calculator history. To distinguish between each saved expression and result, every other entry line is shaded. To view entry lines that are hidden, drag the work area up or down to scroll.

Entering Simple Math Expressions

Note: To enter a negative number, tap  instead of the minus sign.

Suppose you want to evaluate $\frac{2^8 \cdot 43}{12}$.

1. Tap an entry line in the Calculator work area.
2. Tap    to begin the expression.

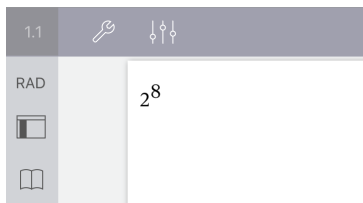

3. Tap  to return the cursor to the baseline.
4. To complete the expression:

Tap      

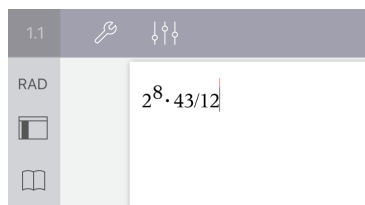

5. Tap **enter** to evaluate the expression.

The expression is displayed in standard mathematical notation, and result is displayed on the right side of the entry line. If a result does not fit on the same line with the expression, it is displayed on the next line.

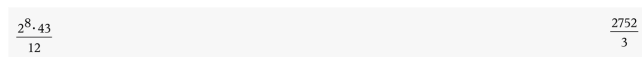

The expression and the result are added to the Calculator history.

Inserting Symbols, Functions, Commands, and Templates

System functions and commands, symbols, and expression templates are stored in Utilities. To access Utilities, tap .

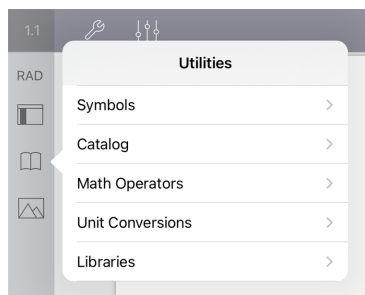

Utilities menus open to the last menu used. For example, if Symbols was the last menu accessed, it opens by default the next time you tap .

To insert a symbol

1. Tap **Symbols** to open the Symbols palette.
2. Tap a symbol to insert it into the entry line.

Note: Drag the list of symbols up and down to view all available symbols.

To insert an item from the catalog

1. Tap **Catalog** to view the list of available functions and commands.
2. Tap a function name to select it, and then tap **Done** to insert it into the entry line.
 - Flick the list of Catalog items up or down to view all items in the list.
 - Type the first letter(s) of a function name in the search field to jump to entries that begin with that letter. To return to the top of the list, clear the search field.
 - To access the Tools Wizard, tap  to hide keyboard.
 - If a Catalog function requires a defined variable, you must [define the variable](#) before you can insert the Catalog item.



To insert a math operator

1. Tap **Math Operators** to view the list of operator types.
2. Tap a category name to open the list of available operators.
3. Tap an operator name, and then tap **Done** to insert it into the entry line.

Using Wizards

Some functions in the Catalog have a wizard that prompts you for each argument. Functions that have wizard support are identified with the wand symbol ()

To enable wizards

1. Tap  to hide the TI-Nspire™ keyboard if it is showing.
2. Tap **Utilities** , and then go to **Catalog**. By default, the **Tools Wizard** is OFF.

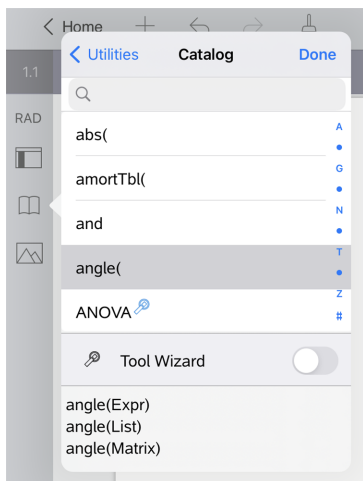

- Slide the button to the right to enable the **Tools Wizard**.
- Select the function you want to insert. (The function must have wizard support.)
- Tap **Done**.

The wizard opens and prompts for each argument before the function is inserted into the entry line.



- Enter the arguments needed for the selected function.

Note: If the keyboard is needed to complete an entry, it opens when you tap the field.
- Tap **OK** as needed to complete entries in each prompt for the selected function.

The selected function is inserted into the Calculator entry line.

Note: If a Catalog function requires a defined variable, you must [define the variable](#) before you can insert the Catalog item.

Using an Expression Template

$$\sum_{n=3}^7 (n)$$

Suppose you want to evaluate $n=3$:

- Tap the entry line to show the keyboard.

2. Tap .

The algebraic sum template is inserted into the entry line. Small blocks represent elements that you can enter.

Note: The blue line on the top of this key indicates this key has alternate functions. Touch and hold the key to access the alternate function.

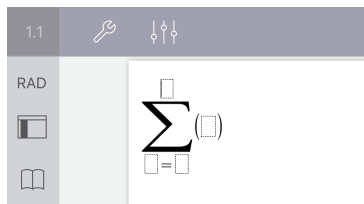

3. Use the arrow keys (or tap each element) to move the cursor to each element's position and enter a value or expression in each position.

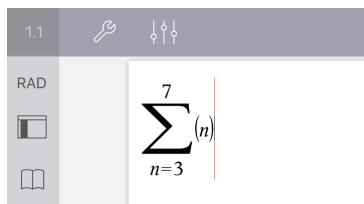





4. Tap **enter** to evaluate the expression.



Using the Unit Conversion Assistant

In any application where math input is allowed, you can generate unit conversions using the Unit Conversion Assistant. This can help reduce syntax errors by automatically entering the units for you.

Example: Convert 528 minutes to hours. The desired expression is $528 \cdot \text{min} \blacktriangleright \text{hr}$.

1. Tap    on the entry line.
2. Tap **Utilities** , then tap **Unit Conversions**.

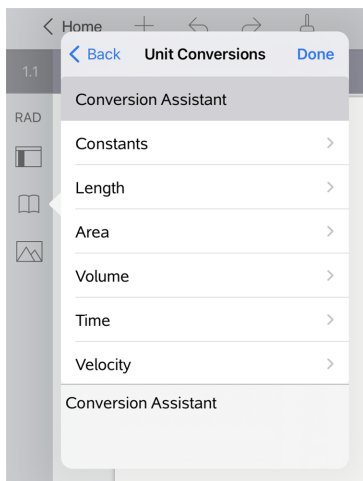

3. Tap **Conversion Assistant**, then tap **Done**.

The **Unit Conversion Assistant** dialog box displays:

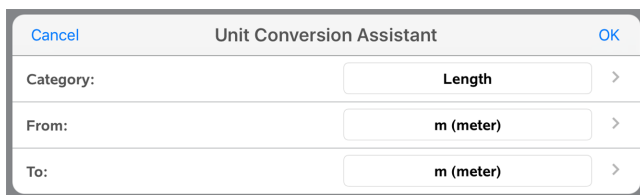

4. Tap the **Category** list and select **Time**. Then tap **< Unit Conversion Assistant**.

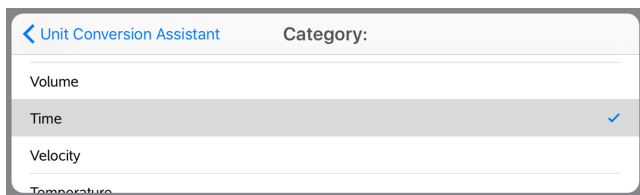

5. Tap the **From** list and select **min (minute)**. Then tap **< Unit Conversion Assistant**.

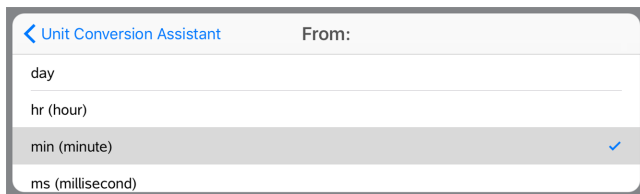

Note: You can select **Use existing unit** at the bottom of the list if you have already entered a unit. In this example, you might have already entered $528 \cdot \text{min}$.

6. Tap the **To** list and select **hr (hour)**. Then tap **< Unit Conversion Assistant**.

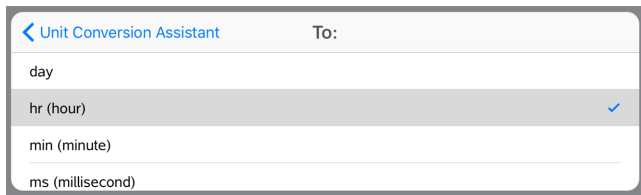

7. Tap **OK** to paste $\text{min} \rightarrow \text{hr}$ to the entry line.
8. Tap **enter** to evaluate the expression.



Note:

- The last Category, From, and To selections will be retained until the language is changed, or the app is uninstalled or upgraded.
- Inserting a conversion into a Notes text field will automatically create a Math Box.
- Inserting a conversion into an empty line in the Calculator will automatically insert **Ans** before the conversion.

Conversion Categories

The following table lists categories that are available in the Unit Conversion Assistant. When the units are pasted to the entry line, underscores () are added before the name of each unit to differentiate them from other variables. For example:

- $\text{cm} \rightarrow \text{m}$
- $\text{km/hr} \rightarrow \text{m/s}$
- $^{\circ}\text{C} \rightarrow ^{\circ}\text{F}$

Categories

- | | | |
|----------|---------------|------------|
| • Length | • Velocity | • Energy |
| • Area | • Temperature | • Power |
| • Volume | • Mass | • Pressure |
| • Time | • Force | |

Variables Overview

A variable is a defined value that can be used multiple times in a problem. You can define a value or function as a variable within each application. Within a problem, variables are shared by TI-Nspire™ applications. For example, you can create a variable in Calculator, and then use or modify that variable in Graphs, Geometry, or Lists & Spreadsheet within the same problem.

Each variable has a name and definition. The definition can be changed, and when you change the definition, all occurrences of the variable in the problem are updated to use the new definition. In the TI-Nspire™ software, a variable has four attributes:

- **Name** - User-defined name assigned when the variable is created.
- **Location** - Variables are stored in memory.
- **Value** - Number, text, mathematical expression, or function.
- **Type** - Type of data that can be stored as a variable.

Variables created with the Local command within a user-defined function or program are not accessible outside of that function or program.

Using Variables in a Problem

- When first created, a variable is available only to the problem where it is defined.
- A variable can be used multiple times in applications that are part of the same problem.
- If the value of the variable is changed in the original application, the change is reflected in all applications where the variable is used.
- A variable is not available to other problems or documents until you define the variable as a library object and copy it to a library folder. See [Libraries](#) for more information.

Defining Variables

Any portion or attribute of an object or function created within an application can be stored as a variable. Examples of attributes that can become variables include the:

- Area of a rectangle
- Radius of a circle
- Value contained in a spreadsheet cell
- Contents of a row or column in a spreadsheet
- Function expression

When you create a variable, it is stored in memory.

Types of Variables



You can store the data types listed in the following table as variables.

Data type	Examples				
Expression	2.54	1.25E6	2π	$(x-2)^2$	$\frac{\sqrt{2}}{2}$
List	{2, 4, 6, 8}	{1, 1, 2}	{"red", "blue", "green"}		
Matrix	$\begin{bmatrix} 1 & 2 & 3 \\ 3 & 6 & 9 \end{bmatrix}$	This can be entered as: [1,2,3;3,6,9]			
Character string	"Hello"	"xmin/10"	"The answer is:"		
Function, program	myfunc(arg)		ellipse(x, y, r1, r2)		
Measurement	area	perimeter	length	slope	angle

Naming Variables and Functions

Names for variables and functions that you create must meet the following naming rules.

Note: If you create a variable with the same name as one used for statistical analysis or by the Finance functions, an error condition could occur. When you enter the name of a variable that is already in use in the current problem, the entry is shown in **bold**.

- Variable names must be in one of the forms *xxx* or *xxx.yyy*. The *xxx* part can have 1 to 16 characters. The *yyy* part, if used, can have 1 to 15 characters. You cannot start or end the variable name with a period (.).
- Characters can consist of letters, digits, and the underscore character (_). Letters can be U.S. or Greek letters (but not Π or π), accented letters, and international characters.
- Do not use **c** or **n** from the symbol palette to construct a variable name such as *c1* or *n12*. These may appear to be letters, but they are treated internally as special symbols.
- You can use uppercase or lowercase letters. The names *AB22*, *Ab22*, *aB22*, and *ab22* all refer to the same variable.
- You cannot use a digit as the first character of *xxx* or *yyy*.
- When entering a subscript, you can use digits zero through 9, U.S. letters, a through z, Latin and Greek letters (but not π) as subscripts (for example, a_2 , q_a , or h_2o). To enter a subscript while typing a variable name, touch and hold , and then slide to select .
- Do not use spaces.
- If you want a variable to be treated as a complex number, use an underscore as the last character of the name.

- CAS: If you want a variable to be treated as a type of unit (such as *_m* or *_ft*), use an underscore as the first character of the name. You cannot use any other underscores in the name.
- You cannot use an underscore as the first character of a name.
- You cannot use a pre-assigned variable, function, or command name, such as *Ans*, *min*, or *tan*.
- Library documents and library objects are subject to additional naming restrictions. For more information, see [Libraries](#).

Creating Variables in Calculator

When creating a variable, use the following conventions. As alternatives to using \rightarrow (store), you can use " := " or the **Define** command. All of the following statements are equivalent.

$$5+8^3 \rightarrow \text{num}$$

$$\text{num} := 5+8^3$$

$$\text{Define num}=5+8^3$$

To Create a Variable in the Calculator Application

1. Tap the Calculator entry line to show the keyboard.
2. Touch and hold  to show the alternate functions, and then slide to the desired function.

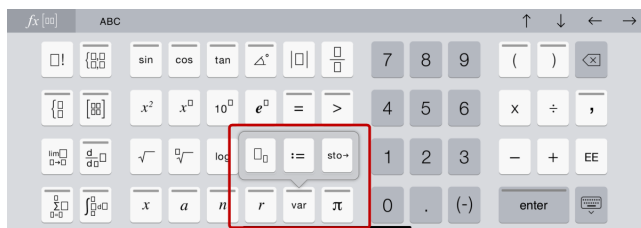

3. Enter the value for the variable (a number, text, mathematical expression, or function).
4. Tap **enter**.

Note: Use the right, left, up, and down arrows to move the cursor within the expression or function. Make sure the cursor is positioned correctly in the entry line before tapping **enter** to create the variable.

Entering Multiple Variables on the Entry Line

To enter several variables on a single line, separate them with a colon (:). Only the result of the last expression is shown.

$$a:=5: b:=2: \frac{a}{b} \cdot 1. \qquad 2.5$$

Creating Variables in Graphs

In the Graphs application, functions defined on the entry line are automatically stored as variables.

In this example, $f1(x)=x^3$ is automatically stored as a variable definition named $f1$, which you can use in other applications in the problem, including a table in the Lists & Spreadsheet application.

When you tap **enter**, the equation is graphed, and the variable is defined. Tap  to see the list of defined variables.

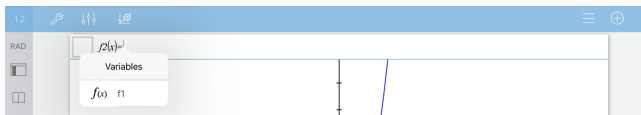

Creating a Variable from a Geometry Value

In this example, the area of the triangle will be the value for a variable named "triangle."

1. Tap the value you want to store to select it, and then tap it again to open the context menu.

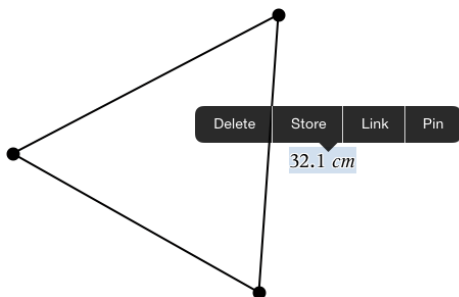

2. Tap **Store**.

$var :=$ appears before the selected value. This is the default name.

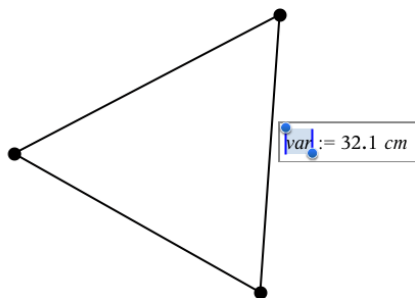

3. Replace the default name *var* with the variable name you want to give the value.
4. Tap **enter**.

The value is saved to that variable name, and the stored value or its name appears in bold text to indicate that it is a stored value.

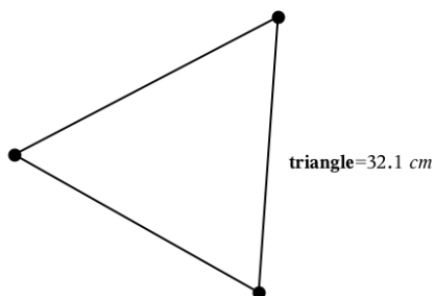

Creating Variables in Lists & Spreadsheet

Naming a list at the top of a Lists & Spreadsheet column or creating a variable from a cell value automatically stores that value as a list variable. After defining the variable, you can link to it from the Graphs, Geometry, Calculator, and Data & Statistics applications as well as from other Lists & Spreadsheet pages within the current problem.

Note: When naming variables, use a name that does not exist in the current problem.

Creating a Variable from a Column Name

1. Tap the column's name cell (the top cell of the column).
2. Type a name for the list variable, and then tap **return**.

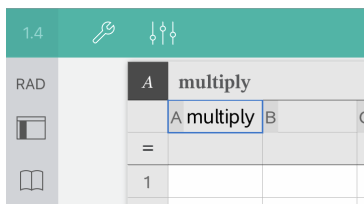

3. Create elements in the list. For example, type data into each cell or use a formula to generate a column of data.

Notes:

- Lists can contain empty elements (denoted by an underscore ("_").
- You can refer to a specific element in a named list from the Calculator application. Use the list name and the element's position within the list. In a list named Heights, for example, refer to the first element as Heights[1]. The expression Heights[2] refers to the second elements, and so on.

Creating a Variable from a Cell Value

You can share a cell value with other TI-Nspire™ applications. When defining or referring to a shared cell in Lists & Spreadsheet, precede the name with an apostrophe (').

1. Tap the cell that contains the value you want to share, and then tap again to open the context menu.

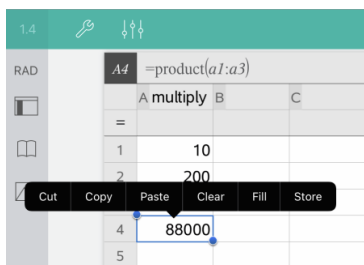

2. Tap **Store**.

A formula is inserted into the cell with *var* as a placeholder for the variable name.

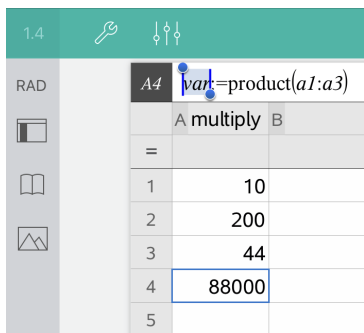

3. Replace the letters "var" with a name for the variable.
4. Tap **return**.

The value is now available as a variable in other applications within the same problem.

Adjusting Variable Values with a Slider

A slider control lets you interactively adjust or animate the value of a numeric variable. You can insert sliders in the Graphs, Geometry, Notes, and Data & Statistics applications.

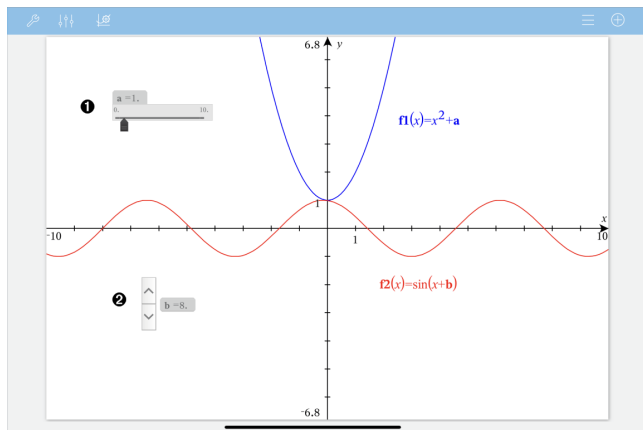

- 1 Horizontal slider for adjusting variable a .
- 2 Minimized vertical slider for adjusting variable b .

Note: TI-Nspire™ version 4.2 or higher is required for opening .tns files containing sliders on Notes pages.

Inserting a Slider Manually

From a Graphs, Geometry, or Data & Statistics page, select **Actions > Insert Slider**.

– OR –

From a Notes page, make sure the cursor is not in a math box or chem box, and then select **Insert > Insert Slider**.

The Slider Settings screen opens.

The screenshot shows the 'Slider Settings' dialog box with the following fields and options:

Field	Value
Variable:	a
Value:	1
Minimum:	-5
Maximum:	5
Step Size:	Automatic
Style:	Horizontal
Display Digits:	Float 3
Minimized	<input type="checkbox"/>
Show Variable	<input checked="" type="checkbox"/>
Show Scale	<input checked="" type="checkbox"/>

2. Enter the desired values, and tap **OK**.

The slider is displayed. On a Graphs, Geometry, or Data & Statistics page, handles are displayed to let you move or stretch the slider.



To remove the handles and use the slider, tap an empty space in the work area. You can show the handles anytime by selecting **Move** from the slider's context menu.

3. To adjust the variable, slide the pointer (or tap the arrows on a minimized slider).

Working with the Slider

Use the options on the context menu to move or delete the slider, and to start or stop its animation. You can also change the slider's settings. To open the context menu:

1. Touch and hold the slider.

The context menu opens.

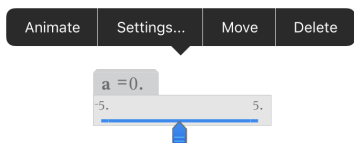

2. Tap an option to select it.

Automatic Sliders in Graphs

Sliders can be created for you automatically in the Graphs application and in the analytic window of the Geometry application. You are offered automatic sliders when you define certain functions, equations, or sequences that refer to undefined variables.

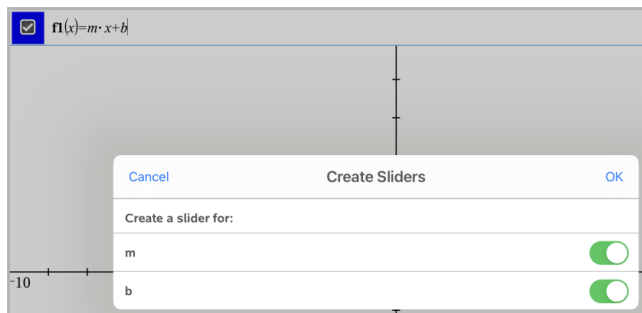

Linking a Lists & Spreadsheet Cell or Column to a Variable

When you link a cell or column to a variable, Lists & Spreadsheet updates the values to reflect the current value of the variable. The variable can be any variable in the current problem and can be defined in Graphs, Geometry, Calculator, or any instance of Lists & Spreadsheet.

Notes:

- You cannot link to the same variable multiple times on the same page.
- Do not link a cell to a system variable. Doing so could prevent the variable from being updated by the system. System variables include *ans*, *StatMatrix*, and statistics results (such as *RegEqn*, *dfError*, and *Resid*).

Linking a Cell Value to an Existing Variable

1. In a Lists & Spreadsheet page, tap the cell that you want to link to a variable. This should be an empty cell and the cell cannot be in a list that is already defined as a variable.
2. Tap the cell again to open the context menu.

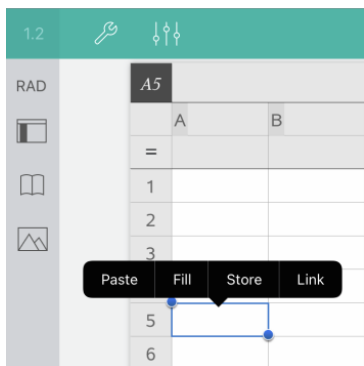

3. Tap Link.

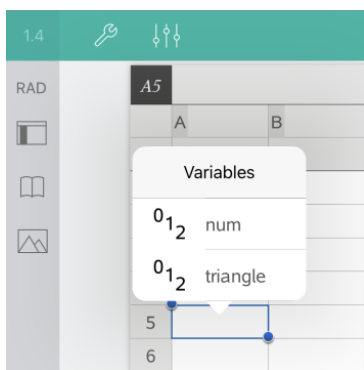

4. Tap the name of the variable to insert it into the cell.

The value of the variable is displayed in the cell.

Linking a Column to an Existing List Variable

To view or edit values in a list variable, link a column to the list variable. The list can be any shared list in the current problem and can be defined in Graphs, Geometry, Calculator, or any instance of Lists & Spreadsheet.

After you link a column to a list, changes you make to the list in other applications are automatically updated in Lists & Spreadsheet.

1. Tap the column formula cell (the second cell from the top) that you want to link to a variable.
2. Type the name of the list variable that you want to link to, and then tap **return**.

– OR –

To view the list of available variables:

- ▶ Tap  on the TI-Nspire™ Keyboard, and then tap a variable name.

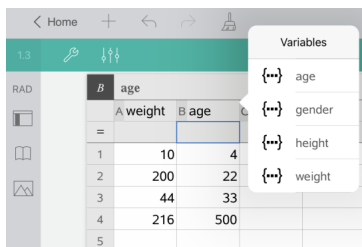

The column shows the list elements.

Locking and Unlocking Variables

Locking a variable protects it from modification or deletion, and prevents unintended changes to a defined variable. For example, you may want to lock variables that define time or altitude to ensure integrity.

You cannot lock the following variables:

- System variable *ans*
- *stat.* and *tvm.* variable groups

Locking Variables

1. Go to the Calculator application, and tap the entry line to show the keyboard.
2. Tap **Tools** .
3. Go to **Actions**, and then tap **Lock**.

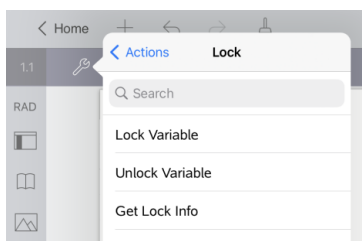

4. Tap **Lock Variable** to select the function and insert it into the entry line.

5. Tap , and then tap the variable name you want to lock.

Note: You can also type the variable name in the entry line.

6. Tap **enter**.

The result *Done* indicates the variable is locked.

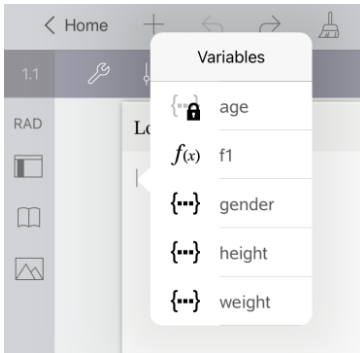

Locked variables display a lock icon on the variable menu list.



Note: The Lock command clears the Redo/Undo history when applied to unlocked variables.

Unlocking Variables

To modify or delete a locked variable, you must unlock the variable.

1. Tap **Tools**  and go to **Actions > Lock**.
2. Tap **Unlock Variable** to enter the function into the entry line.
3. Tap , and then tap the locked variable name.
4. Press **enter** to remove the locked status.

The result *Done* indicates the variable is now unlocked.

Graphs Application

The Graphs application lets you create, manipulate, analyze, and trace graphs of mathematical relations.

What You Can Do

- Define and explore functions and other relations, such as inequalities, parametrics, polars, sequences, and differential equation solutions.
- Graph and explore linear and conic equations analytically in a two-dimensional coordinate system. Analyze lines, circles, ellipses, parabolas, hyperbolas, and general conic equations.
- Animate points on objects or graphs and explore their behavior.
- Define relations to share with other applications, such as Calculator or Notes.
- Link to data created by other applications.

Tools Search

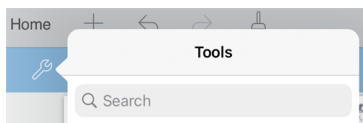

Tools Search allows you to search options and menus. It is available across all applications in the TI-Nspire™ App.

Warning: Tools Search will allow you to search for menu items, but not for command names.

What You Must Know

Finding Hidden Objects in the Graphs or Geometry Application

You can hide graphs, geometric objects, text, labels, measurements, and individual axis end-values.

To temporarily view hidden graphs or objects or to restore them as shown objects, tap **Tools**  and go to **Actions > Hide/Show**. Tap a graph or object to toggle its Hide/Show state.

Changing the Appearance of a Graph or Object

1. Tap the graph or object that you want to change.
2. Tap the **Inspector**  to display a list of the object's attributes.

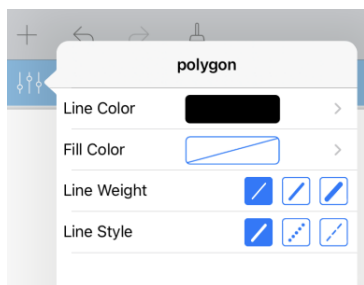

Note: The list of attributes is different for different types of objects.

3. Select the items to change. Changes are applied as you select them.

Animating a Point on a Graph or Object

1. Tap the point.
2. Tap **Inspector**  to display the point's attributes.

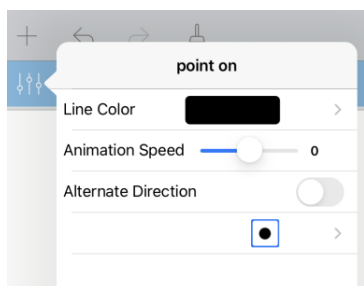



3. Drag the Animation Speed slider to set the speed and start the animation.

Inserting a Background Photo

The **Insert Photo**  tool lets you [insert a photo](#) as a background for any Graphs or Geometry page.

Adding Text to the Graphs or Geometry Work Area

1. Tap **Tools**  and go to **Actions > Text**.

The Text tool  appears in the application Toolbar.

2. Tap the location for the text.
3. Type the text in the box that appears, and then tap **return**.

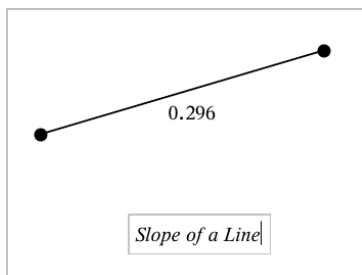

4. To edit the text, double-tap it.

Adding a Graphs Page



To get started with the Graphs application, add a Graphs page to an existing document.

Tap **Add**, and then tap .

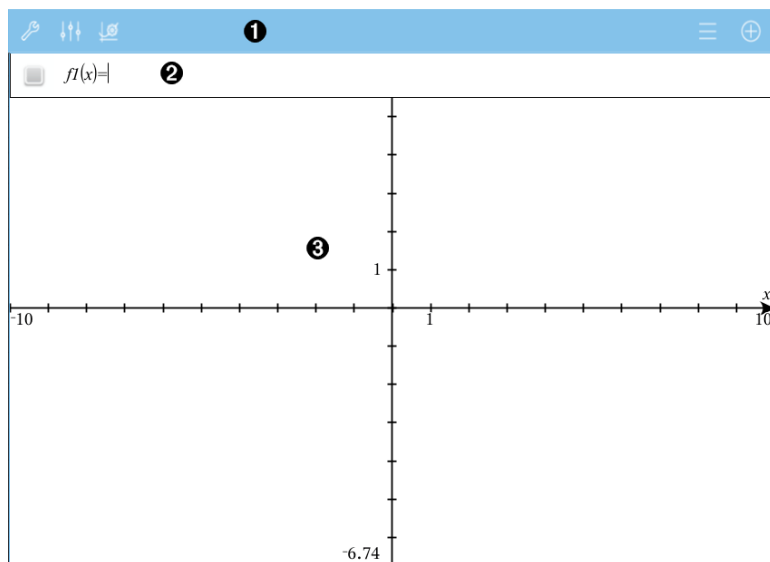
A new Graphs page appears, showing the Graphs Toolbar, entry line, and work area.



1 Graphs Toolbar

- Tap **Tools**  to create and explore graphs.
- Tap **Inspector**  to change the appearance of a graph.
- Tap  to change the settings used by the Geometry and Graphs

applications.

- Tap \equiv to view or edit an expression from the graph history.
- Tap \oplus to hide or show the keyboard and the entry line.

② **Entry line.** Lets you define the relations that you want to graph. The default graph type is Function, so the form $f1(x)=$ is displayed initially. You can define 99 relations of each type.

③ **Graphs Work Area**

- Shows graphs of relations that you define on the entry line.
- Shows points, lines, and shapes that you create with geometry tools.
- Pinch to zoom, drag to pan (affects only those objects created in the Graphs application).

Graphing Functions

1. In the Graphing view, tap **Tools** \mathcal{S} and go to **Graph Entry/Edit > Function**.

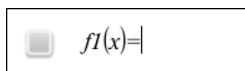

2. Type an expression for the function.

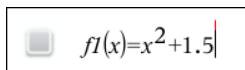

3. Tap **enter** to graph the function.

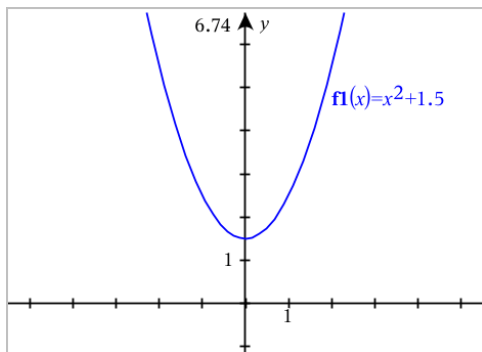

Manipulating a Function by Dragging

Linear Function	<ul style="list-style-type: none">• To translate, grab near the middle of the graph, and then drag.• To rotate, grab near the ends of the graph, and then drag.
Quadratic Function	<ul style="list-style-type: none">• To translate, grab near the vertex of the graph, and then drag.• To stretch, grab away from the vertex of the graph, and then drag.
Sine or Cosine Function	<ul style="list-style-type: none">• To translate, grab near the axis of vertical symmetry of the graph, and then drag.• To stretch, grab away from the axis of vertical symmetry of the graph, and then drag.

Finding Points of Interest on a Function Graph

- [Create a point on the graph](#), and then drag the point to quickly identify maximums, minimums, and zeros.

Temporary signposts appear as you drag through the points of interest.

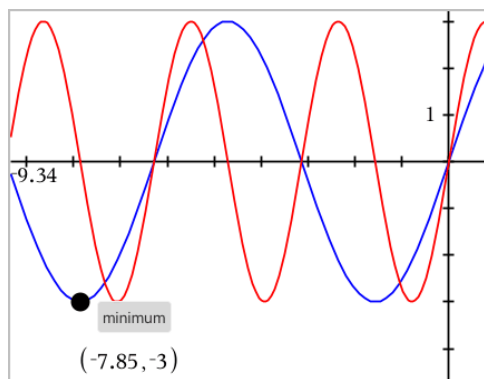

- For other points of interest, tap **Tools** , select **Analyze Graph**, and select the type of analysis, such as **Integral**. The application prompts you to choose a graph and define the boundaries.

Note: For information about path plots, see [Exploring Graphs with Path Plot](#).

Exploring Graphs with Path Plot

Path Plot lets you animate function, parametric, and polar equation plots in real time to analyze how they are plotted and not just the final plot.

Changing the Path Plot Settings

1. In the Graphing view, tap Tools  and go to **Trace > Path Plot > Path Setup**.
2. Select the settings you want to use.
 - **Graph Type:** Selects Function, Parametric, or Polar as the graph type.
 - **Path Step:** Sets the increment of the independent variable at which values are plotted.
 - **Show Future Path:** Toggles the display of all future points for each function past the starting or current point of the graph. You can also toggle this when viewing the graph with the Up/Down arrow keys.
 - **Show Point Coordinates:** Toggles the display of the coordinates for recorded trace points.

Enabling Path Plot

1. Enter your equation(s).
2. From the **Trace** menu, select **Path Plot > Function/Parametric/Polar**.
3. Navigate through the animation by:
 - using the Play/Pause/Reset Animation icons
 - using the Left/Right arrow keys
 - entering a number to jump to that point

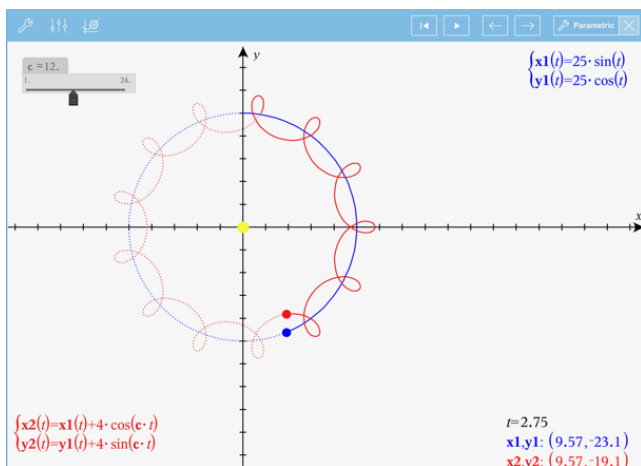

Graphing Linear and Conic Equations

1. In the Graphing view, tap Tools  and go to **Graph Entry/Edit > Equation**.
2. Tap the type of equation (**Line, Parabola, Circle, Ellipse, Hyperbola, or Conic**).
3. Tap the specific template for the equation. For example, tap $y = a \cdot x^2 + b \cdot x + c$ to define a parabola.

The entry line includes a symbol to indicate the type of equation.

e1 $y = \square \cdot x^2 + \square \cdot x + \square$

4. Type the coefficients into the equation template.

e1 $y = 1 \cdot x^2 + 2 \cdot x + 3$

5. Tap **enter**.

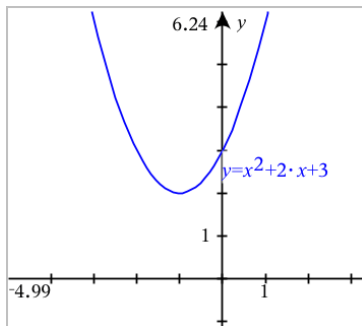

Graphing Relations

Relation graphing is available on Graphs pages and in the Analytic Window of Geometry pages.

You can define relations using \leq , $<$, $=$, $>$, or \geq . The inequality operator (\neq) is not supported in relation graphing.

Relation type	Examples
Equations and inequalities equivalent to $y = f(x)$	<ul style="list-style-type: none"> $y = \sqrt{x}$ $y - \sqrt{x} = 1/2$ $-2 \cdot y - \sqrt{x} = 1/2$ $y - \sqrt{x} \geq 1/2$ $-2 \cdot y - \sqrt{x} \geq 1/2$
Equations and inequalities equivalent to $x = g(y)$	<ul style="list-style-type: none"> $x = \sin(y)$ $x - \sin(y) = 1/2$ $x - \sin(y) \geq 1/2$
Polynomial equations and inequalities	<ul style="list-style-type: none"> $x^2 + y^2 = 5$ $x^2 - y^2 \geq 1/2 + y$ $x^3 + y^3 - 6 \cdot x \cdot y = 0$
The above relations on domains restricted by rectangles	<ul style="list-style-type: none"> $y = \sin(x)$ and $-2\pi < x \leq 2\pi$ $y \leq x^2 \mid y \geq -2$ and $0 \leq x \leq 3$

Relation type	Examples
	<ul style="list-style-type: none"> $\{x^2+y^2 \leq 3, y \geq 0 \text{ and } x \leq 0\}$

To Graph a Relation:

- From the **Graph Entry/Edit** menu, select **Relation**.

$rel1(x,y)$
|

- Type an expression for the relation. You can touch and hold the "greater than" key $>$ to select one of the relation operators.

$rel1(x,y)$
 $x - \sin(y) \geq 1/2$

- Press **enter** to graph the relation.

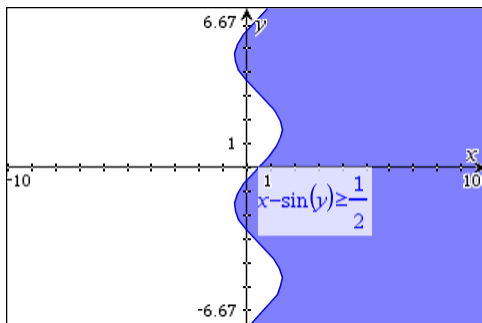

Tips for Graphing Relations

- You can quickly define a relation from the Function entry line. Position the cursor to the immediate right of the = sign, and then tap the backspace key \leftarrow .

A small menu appears with the relation operators and a **Relation** option. Choosing from the menu places the cursor in the Relation entry line.

- You can type a relation as text on a Graphs page and then drag the text object over either axis. The relation is graphed and added to the relation history.

Warning and Error Message

Error Condition	Additional Information
Relation input not supported	Relation input not supported Note: The following relation inputs are

Error Condition	Additional Information
	<p>supported:</p> <ul style="list-style-type: none"> • Relations using \leq, $<$, $=$, $>$, or \geq. • Polynomial relations in x and y • Relations equivalent to $y=f(x)$ or $x=g(y)$ or corresponding inequalities • The above relations on domains restricted by rectangles
Domain Restrictions not supported for certain classes of relations equivalent to $y=f(x)$ or $x=g(y)$ or corresponding inequalities.	<ul style="list-style-type: none"> • Relations equivalent to $y=f(x)$ and corresponding inequalities can only have constraints on x • For example: $y=\sqrt{x}$ and $0\leq x\leq 1$ will work but $y=\sqrt{x}$ and $0\leq y\leq 1$ will not • Relations equivalent to $x=g(y)$ and corresponding inequalities can only have constraints on y • For example: $x=\sin(y)$ $-1\leq y\leq 1$ will work but $x=\sin(y)$ $-1\leq x\leq 1$ will not

Graphing Parametric Equations

1. In the Graphing view, tap **Tools**  and go to **Graph Entry/Edit > Parametric**.

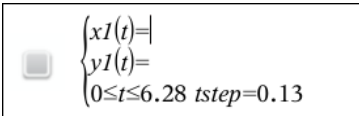

$$\begin{cases} x1(t)= \\ y1(t)= \\ 0\leq t\leq 6.28 \quad tstep=0.13 \end{cases}$$

2. Type expressions for $xn(t)$ and $yn(t)$.

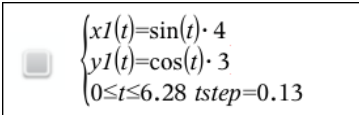

$$\begin{cases} x1(t)=\sin(t)\cdot 4 \\ y1(t)=\cos(t)\cdot 3 \\ 0\leq t\leq 6.28 \quad tstep=0.13 \end{cases}$$

3. (Optional) Edit the default values for $tmin$, $tmax$, and $tstep$.
4. Tap **enter**.

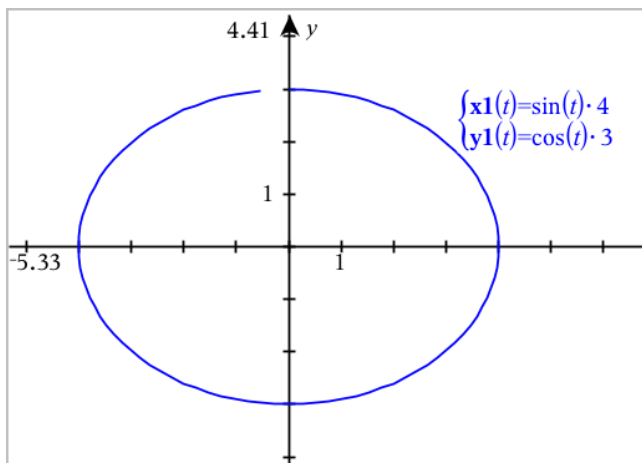

Note: For information about path plots, see [Exploring Graphs with Path Plot](#).

Graphing Polar Equations

1. In the Graphing view, tap **Tools**  and go to **Graph Entry/Edit > Polar**.

$$\begin{cases} r1(\theta) = | \\ 0 \leq \theta \leq 6.28 \quad \theta\text{step} = 0.13 \end{cases}$$

2. Type an expression for $rn(\theta)$.
3. (Optional) Edit the default values for θ_{min} , θ_{max} , and θ_{step} .

$$\begin{cases} r1(\theta) = .2 \cdot \theta \\ 0 \leq \theta \leq (\pi \cdot 10) \quad \theta\text{step} = 0.13 \end{cases}$$

4. Tap **enter**.

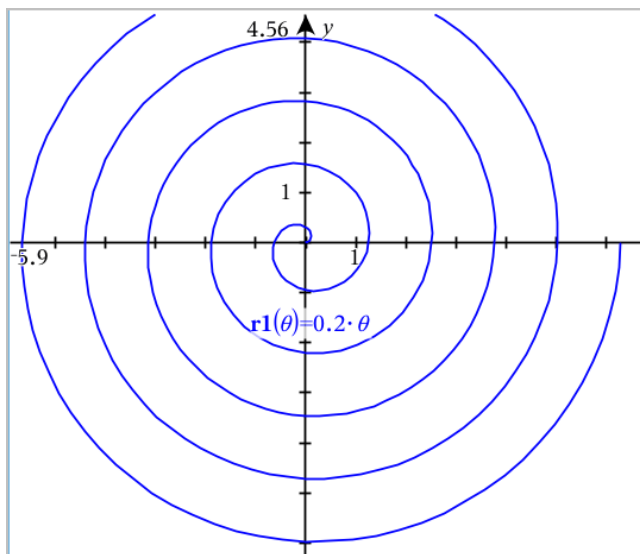

Note: For information about path plots, see [Exploring Graphs with Path Plot](#).

Using the Text Tool to Graph Equations

1. In the Graphs application, tap **Tools**  and go to **Actions > Text**.
2. Tap the work area to place the text box and display the keyboard.
3. Type an "x=" or "y=" equation, such as $x = \sin(y) * 2$, or type an inequality, such as $x < 2 * \sin(y)$, and tap **enter**.
4. Drag the text object to either axis to graph the equation.

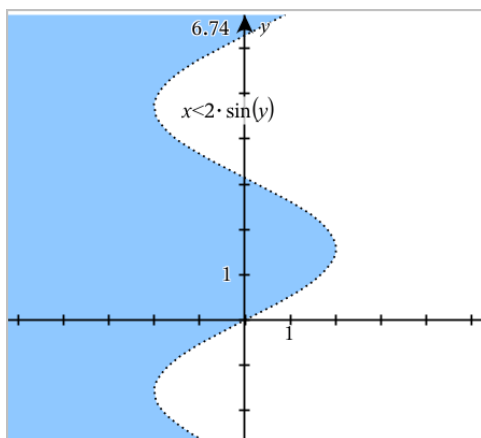

Graphing a Scatter Plot

1. In the Graphs application, tap **Tools**  and go to **Graph Entry/Edit > Scatter Plot**.

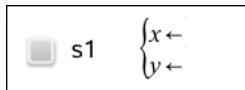

2. Use one of the following methods to specify two lists to plot as x and y.
 - Tap  to select a list variable that you have defined in the current problem.
 - Type the name of an existing list variable, such as **v1**.
 - Type the list elements directly (for example, type **{1, 2, 3}**).

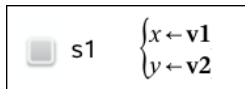

3. Tap **enter** to plot the data, and then [zoom the work area](#) to view the plotted data.

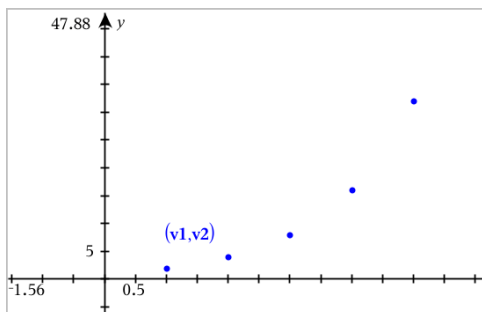

Plotting Sequences

Defining a Sequence

1. In the Graphing view, tap **Tools**  and go to **Graph Entry/Edit > Sequence > Sequence**.

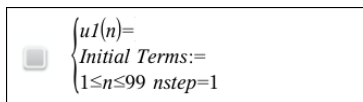

2. Type the expression to define the sequence. Update the independent variable field to $m+1$, $m+2$, etc., if necessary.
3. Type an initial term. If the sequence expression references more than one prior term, such as $u1(n-1)$ and $u1(n-2)$, (or $u1(n)$ and $u1(n+1)$), separate the terms with commas.



$$\begin{cases} u1(n)=1.1 \cdot u1(n-1)+1 \\ \text{Initial Terms}:=1 \\ 1 \leq n \leq 99 \text{ nstep}=1 \end{cases}$$

4. Tap **enter**.

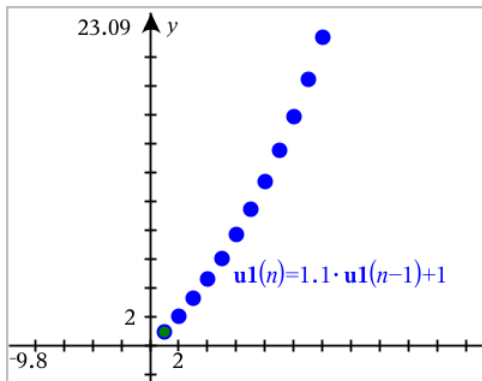

Defining a Custom Sequence

A custom sequence plot shows the relationship between two sequences by plotting one on the x axis and the other on the y axis.

This example simulates the Predator-Prey model from biology.

1. Use the relations shown here to define two sequences: one for a rabbit population, and another for a fox population. Replace the default sequence names with **rabbit** and **fox**.



$$\begin{cases} \text{rabbit}(n)=\text{rabbit}(n-1) \cdot (1+0.05-0.001 \cdot \text{fox}(n-1)) \\ \text{Initial Terms}:=200 \\ 1 \leq n \leq 400 \text{ nstep}=1 \end{cases}$$



$$\begin{cases} \text{fox}(n)=\text{fox}(n-1) \cdot (1+2. \text{E}-4 \cdot \text{rabbit}(n-1)-0.03) \\ \text{Initial Terms}:=50 \\ 1 \leq n \leq 400 \text{ nstep}=1 \end{cases}$$

.05 = the growth rate of rabbits if there are no foxes

.001 = the rate at which foxes can kill rabbits

.0002 = the growth rate of foxes if there are rabbits

.03 = the death rate of foxes if there are no rabbits

Note: If you want to see the plots of the two sequences, [zoom the window](#) to the **Zoom - Fit** setting.

2. Tap **Tools**  and go to **Graph Entry/Edit > Sequence > Custom**.
3. Specify the **rabbit** and **fox** sequences to plot on the x and y axes, respectively.

p1

$$\begin{cases} x \leftarrow \text{rabbit}(n) \\ y \leftarrow \text{fox}(n) \\ 1 \leq n \leq 400 \text{ nstep}=1 \end{cases}$$

4. Tap **enter** to create the custom plot.
5. [Zoom the window](#) to the **Zoom - Fit** setting.

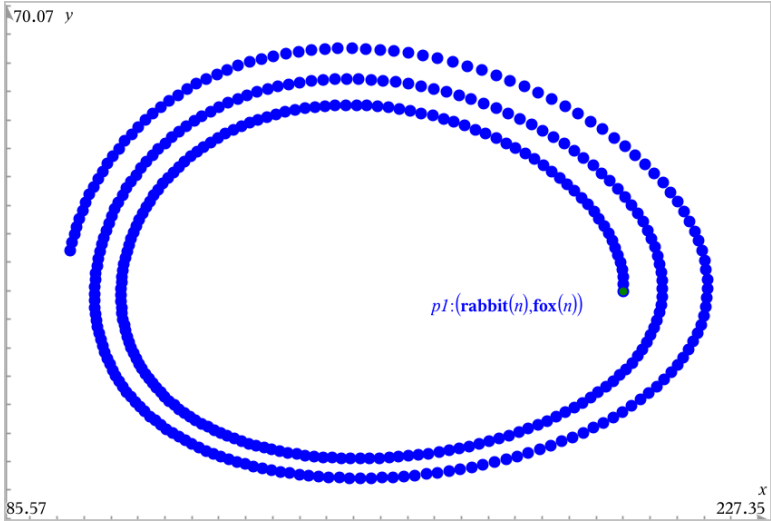

6. Explore the custom plot by dragging the point that represents the initial term.

Graphing Differential Equations

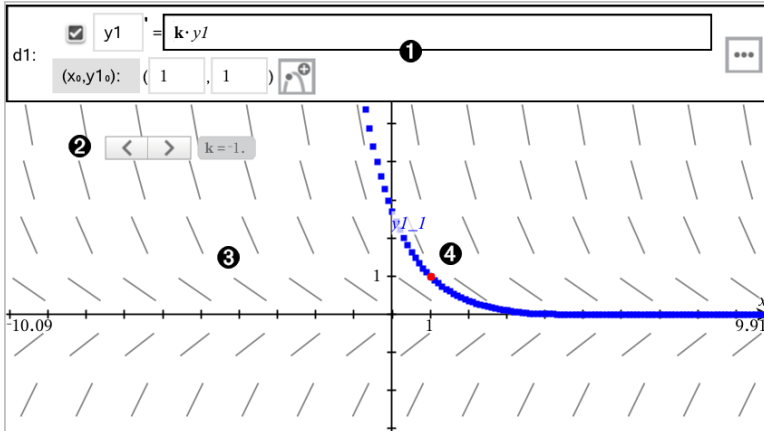

- 1 ODE entry line:
 - **y1** ODE identifier
 - Expression **k·y1** defines the relation
 - Fields **(1,1)** for specifying initial condition
 - Buttons for adding initial conditions and setting plot parameters
- 2 Slider added for adjusting coefficient **k** of the ODE
- 3 Slope field
- 4 A solution curve passing through the initial condition

To Graph a Differential Equation:

1. In the Graphing view, tap **Tools**  and go to **Graph Entry/Edit > Diff Eq.**

The ODE is automatically assigned an identifier, such as “y1.”

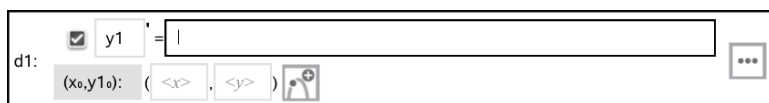

2. Move to the relation field and enter the expression that defines the relation. For example, you might enter $-y1+0.1*y1*y2$.

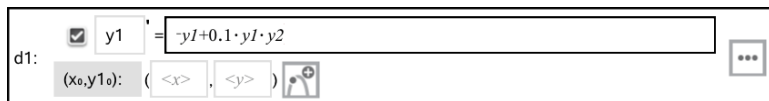

3. Enter the initial condition for the independent value x_0 and for $y1_0$.

Note: The x_0 value(s) are common to all the ODEs in a problem but can be entered or modified only in the first ODE.

4. Tap Edit Parameters  to set the plot parameters. Select a numerical Solution Method, and then set any additional parameters. You can change these parameters anytime.

Cancel	Differential Equation	OK
Solution Method	Euler	>
Iterations Between Plot Step	1	>
Field	Slope	>
Axes	Default (x and y)	>
x←	x	>
y←	y1	>
Plot Start:	-10	>
Plot End:	10	>
Plot Step:	0.1	>
Field Resolution:	14	>
Direction Field at x=	0	>

- Tap **OK**.
- [Zoom the window](#) as necessary to view the graph.

Viewing Tables in the Graphs Application

Tap **Tools**  and go to **Table > Split-screen Table**.

The table is displayed with columns of values for the currently defined relations.

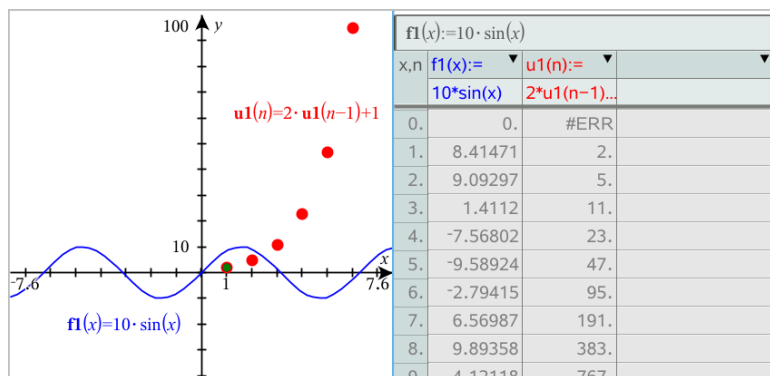

To remove the table, tap **Tools**  and go to **Table > Remove Table**.

Note: For details about using tables, see [Working with Tables](#).

Accessing the Graph History

For each problem, the Graphs application automatically stores a history of defined relations, such as functions **f1** through **f99** and sequences **u1** through **u99**. You can view and edit these items.

Viewing the History of the Current Relation Type

1. Tap **History**  at the right end of the Graphs toolbar to show the history of the current relation type (for example, **f** for Functions).

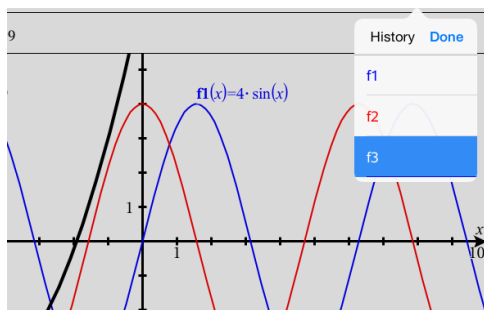

2. In the History list, tap the name of the relation, and then tap **Done** to show the relation in the entry line.
3. Use the up and down arrow keys to scroll through the defined relations.

Viewing the History of other Relation Types

1. In the Graphing view, tap **Tools** , go to **Graph Entry/Edit**, and tap the relation type. For example, tap **Polar** to show an entry line for the next available Polar relation.
2. Use the up and down arrow keys to scroll through the defined relations.

Customizing the Graphs Work Area

Note: Rescaling in the Graphs application affects only the graphs, plots, and objects that reside in the Graphing view. It has no effect on objects in the underlying Plane Geometry view.

Zooming/Rescaling Manually

- ▶ To rescale the x and y axes proportionally, pinch the work area.
- ▶ To rescale only one axis, tap **Tools** , select **Actions > Constrained Movement**, and then drag along the axis.



Zooming to predefined settings

- ▶ Tap **Tools** , select **Window/Zoom**, and select one of the predefined Zoom settings. The initial setting is **Zoom - Standard**.

Displaying the Grid

1. In the Graphs application, tap **Tools**  and go to **View > Grid**.
2. Tap **Dot Grid**, **Lined Grid**, or (if the grid is already displayed) **No Grid**.

Changing the Appearance of the Grid

1. In the Graphs application, tap **Tools**  and go to **Actions > Select Grid**.
The grid will flash.
2. Tap the Inspector  to show a list of attributes that you can change.

Changing the Appearance of the Graph Axes

1. Tap either axis to select the axes.
2. Tap the Inspector  to show a list of attributes that you can change.

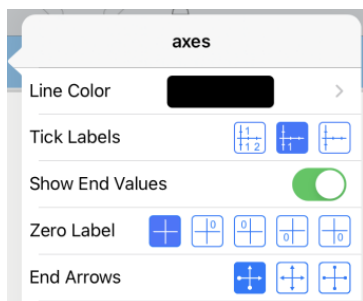

3. Select the items to change. Changes are applied as you select them.

Multiple Tick Mark Labels

Multiple labels are only displayed if they fit both horizontally and vertically on the axes. Rescale the Axes if necessary by pinching or spreading either the horizontal or vertical axis to modify its scale.

– OR –

Drag either axis to shift the axis while retaining its scale.

To restore the original size and location of the plotted data, tap **Tools > Window / Zoom > Zoom-Data**.

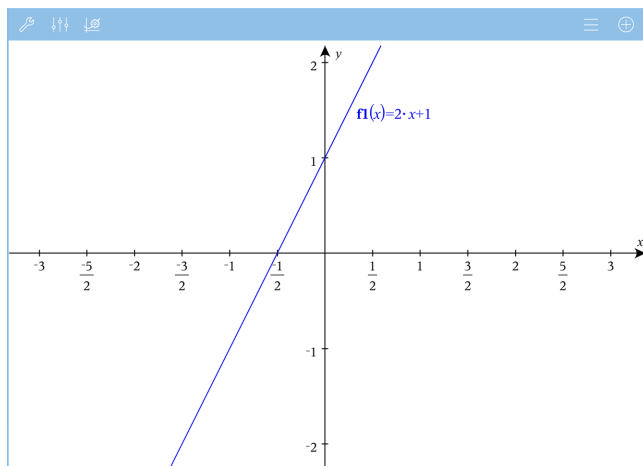

Exact Arithmetic and CAS Only: You can change the tick mark labels to display multiples of Pi, radical numbers, and other exact values by editing the **XScale** or **YScale** values in the **Window / Zoom > Settings**.

Note: $\pi/2$ will be converted to $\frac{\pi}{2}$ after clicking **OK**.

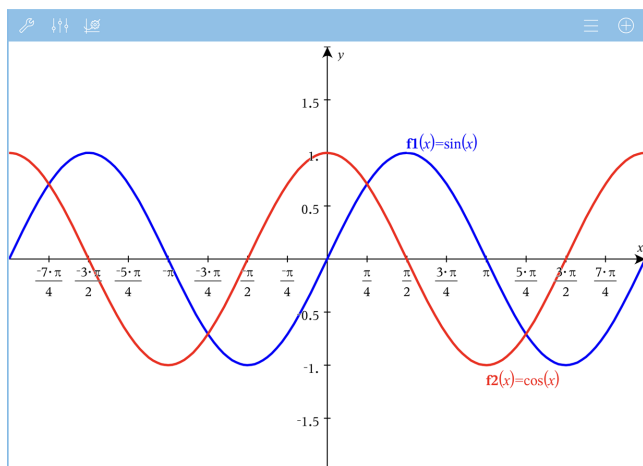



Note: For information about path plots, see [Exploring Graphs with Path Plot](#).

Tracing Graphs or Plots

1. In the Graphing view, tap **Tools**  and go to **Trace > Graph Trace**.

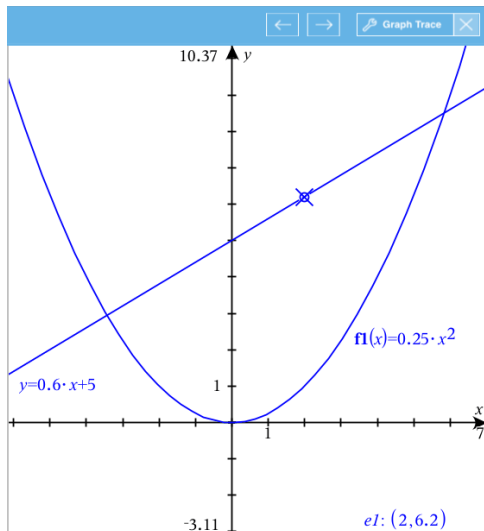
The Graph Trace tool appears in the Graphs toolbar, the trace cursor appears, and the cursor coordinates are displayed in the lower right corner.



2. Explore a graph or plot:
 - Tap a point on a graph or plot to move the trace cursor to that point.
 - Tap  or  on the Graph Trace tool to step the cursor along the current graph or plot. The screen pans automatically to keep the cursor in view.
 - Double-tap the trace cursor to enter a specific independent value.
 - Tap and hold the trace cursor to create a persistent point.
3. To stop tracing, tap the **X** on the Graph Trace tool.

Introduction to Geometric Objects

Geometry tools are accessible in both the Graphs and Geometry applications. You can use these tools to draw and investigate objects such as points, lines, and shapes.

- The Graphing view shows the Graphs work area superimposed on the Geometry work area. You can select, measure, and alter objects in both work areas.
- The Plane Geometry view shows only the objects created in the Geometry application.

Objects Created in the Graphs Application

Points, lines, and shapes created in the Graphs application are analytic objects.

- All points that define these objects reside on the x,y graph plane. Objects created here are visible only in the Graphs application. Changing the axes scale affects the appearance of the objects.
- You can display and edit the coordinates of any point on an object.
- You can display the equation of a line, tangent line, circle shape, or geometric conic created in the Graphs application.

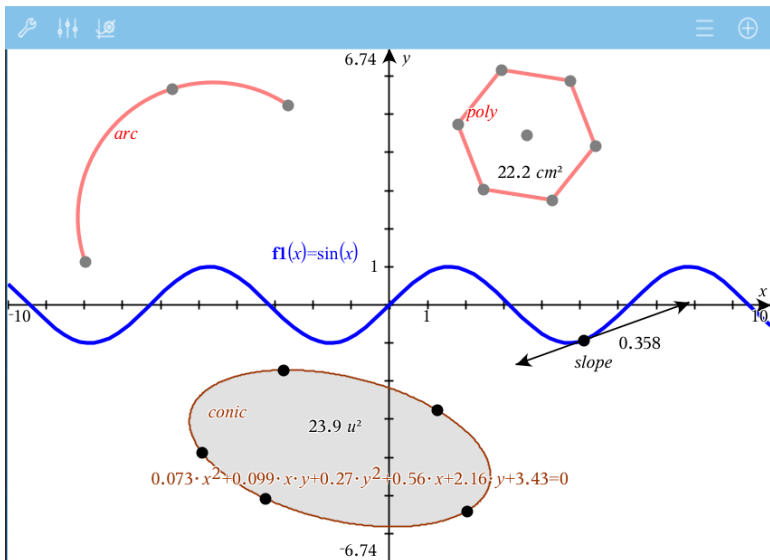

The circle arc and polygon were created in the Geometry application. The sine wave and conic were created in the Graphs application.

Objects Created in the Geometry Application

Points, lines, and shapes created in the Geometry application are not analytic objects.

- Points that define these objects do not reside on the graph plane. Objects created here are visible in both the Graphs and Geometry applications, but they are unaffected by changes to the Graphs x,y axes.
- You cannot obtain the coordinates of an object's points.

- You cannot display the equation of a geometric object created in the Geometry application

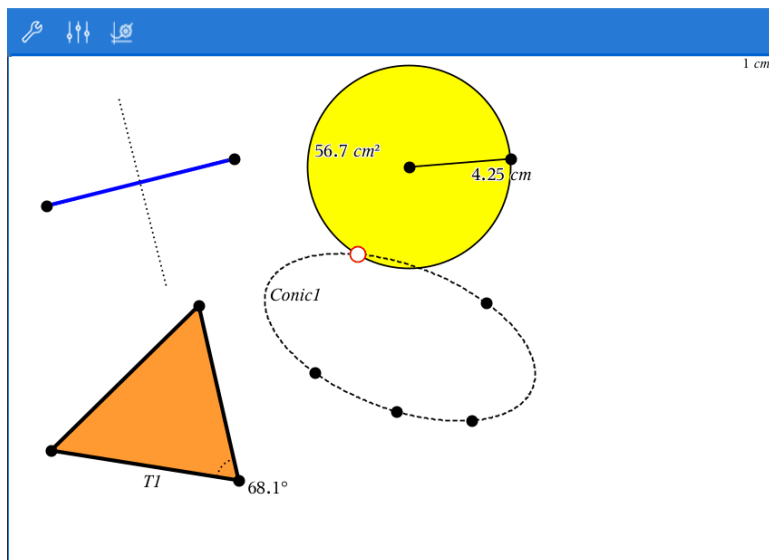



Creating Geometric Objects

You can create objects in both the Geometry and Graphs applications.



Creating Points and Lines

- Tap **Tools** , select **Points and Lines**, and select the type of object, such as **Segment**. (In the Graphs application, go to **Geometry > Points and Lines > Segment**.)
- Tap existing points or locations on the work area to define the object. For example, tap two objects when creating Intersection points.

As you create the object, a tool is shown in the application Toolbar (for example, **Segment**  **Segment** ). To cancel, tap the **X** on the tool.

Creating Geometric Shapes

- Tap **Tools** , select **Shapes**, and select the type of object, such as **Polygon**. (In the Graphs application, go to **Geometry > Shapes > Polygon**.)
- Tap existing points or locations on the work area to define the object. For example, tap two locations to define the center and radius of a circle.

As you create a shape, a tool is shown in the application Toolbar (for example, **Polygon**  **Polygon** ). To cancel the shape, tap the **X** on the tool.

Measuring and Transforming Geometric Objects

Measuring Objects

1. Tap **Tools** , select **Measurement**, and select the type of measurement, such as **Length**. (In the Graphs application, go to **Geometry > Measurement > Length**.)
2. Tap the object you want to measure.

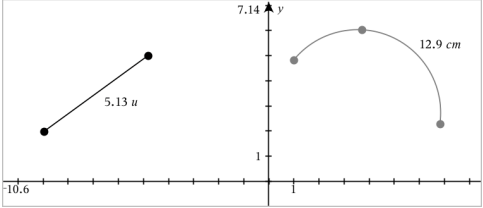
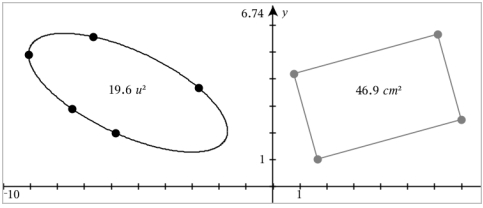
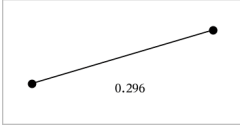
Measurement Type	Use to Measure...
<p>Length</p> 	<ul style="list-style-type: none"> • Length of a segment, circle arc, or vector • Distance Between Two Points, a Point and a Line, or a Point and a Circle • Circumference of a Circle or Ellipse or the Perimeter of a Polygon, Rectangle, or Triangle • A side of a triangle, rectangle, or polygon. You must tap <i>two points</i> to measure a side. Tapping the side measures the entire length of the object's perimeter.
<p>Area</p> 	<p>Area of a Circle, Ellipse, Polygon, Rectangle, or Triangle</p>
<p>Slope</p> 	<p>Slope of a Line, Ray, Segment, or Vector</p>
<p>Angle</p>	<p>Angles in the range from 0° to 180° (0 radians to π radians in the Graphs application)</p>

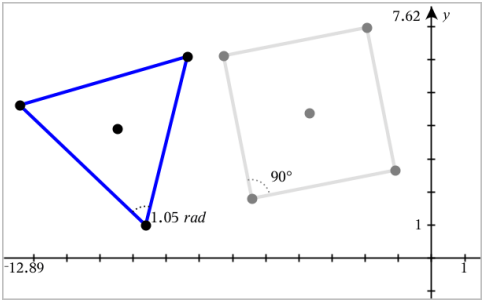
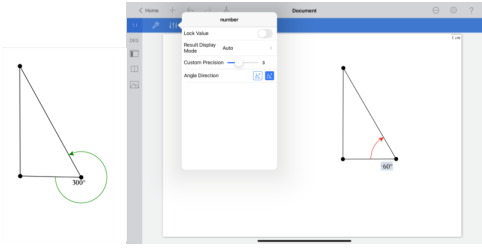

Measurement Type	Use to Measure...
	
<p data-bbox="91 457 233 482">Directed Angle</p> 	<p data-bbox="647 457 937 561">Directed angles in the range from 0° to 360° (0 radians to 2π radians) and from -360° to 0° (-2π radians to 0 radians).</p>

Transforming Objects

1. Tap **Tools** , select **Transformation**, and select the type of transformation, such as **Symmetry**. (In the Graphs application, go to **Geometry > Transformation > Symmetry**.)
2. Tap the object you want to transform.
3. Tap a location, existing point, or other object to create the transformation.

Exploring with Construction Tools

To add a construction, tap **Tools** , select **Construction**, and select the type of construction, such as **Parallel**. (In the Graphs application, go to **Geometry > Construction > Parallel**.)

While a construction is in progress, a tool appears in the application Toolbar (for example, **Parallel**  **Parallel** ). To cancel, tap the **X** on the tool.

Construction Type	Description
Midpoint	Bisects a segment or sets a midpoint between any two points. The points can

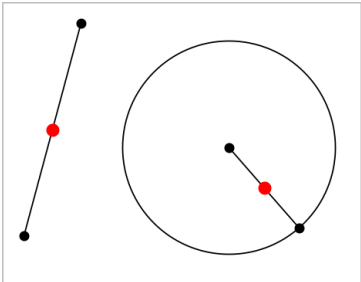
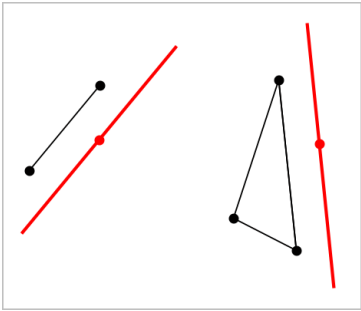
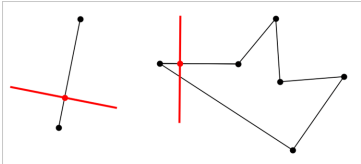
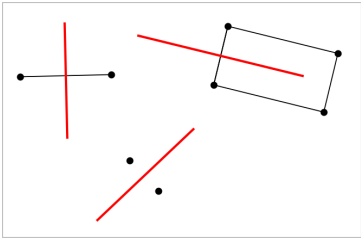
Construction Type	Description
	<p>be on a single object, on separate objects, or on the work area.</p>
<p>Parallel Line</p> 	<p>Creates a parallel line with respect to any existing line. The existing line can be a Graphs axis or any side of a triangle, square, rectangle, or polygon.</p>
<p>Perpendicular Line</p> 	<p>Creates a line that is perpendicular to a reference line. The reference can be an axis, an existing line, a segment, or one side of a triangle, rectangle, or polygon.</p>
<p>Perpendicular Bisector</p> 	<p>Creates a perpendicular bisector on a segment, on one side of a triangle, rectangle, or polygon, or between any two points.</p>

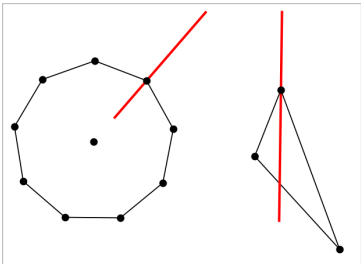
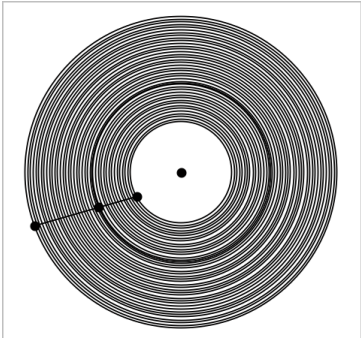
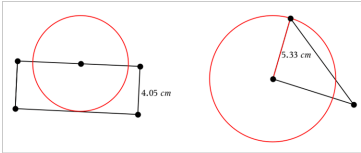
Construction Type	Description
<p data-bbox="91 122 228 145">Angle Bisector</p> 	<p data-bbox="526 122 907 200">Creates an angle bisector. The points of the angle can be on existing objects, or they can be locations on the work area.</p>
<p data-bbox="91 451 146 475">Locus</p> 	<p data-bbox="526 451 928 529">Lets you explore the range of motion of one object with respect to another object as constrained by a shared point.</p>
<p data-bbox="91 859 177 882">Compass</p> 	<p data-bbox="526 859 935 906">Operates similarly to a geometric compass used for drawing circles on paper.</p>

Labeling (Identifying) the Coordinates of a Point

The Graphs application can identify and label the coordinates of any existing point, provided the point was created in the Graphs application.

1. Tap the point to select it, and then tap it again to show its context menu.

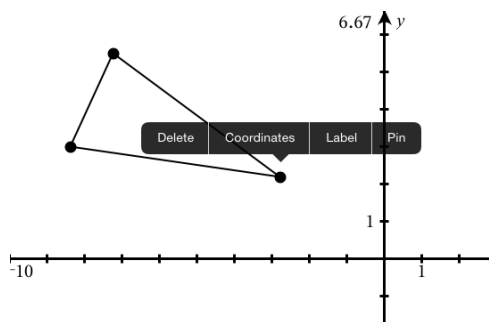

2. Tap **Coordinates**.

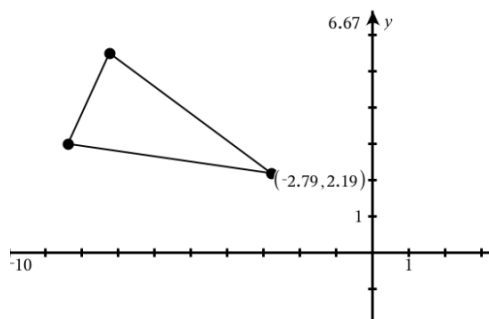

If you move the point to a different location, the coordinates follow the point and update automatically.

Bounded Area (Area Between Curves)

Note: To avoid unexpected results when using this feature, make sure the document setting for "Real or Complex Format" is set to **Real**.

You can use the Graphs application to access the area between curves.

When you calculate the area between curves, each curve must be:

- A function with respect to x .
- OR –
- An equation in the form $y=$, including $y=$ equations defined through a text box or a conic equation template.

Defining Bounded Area (Area Between Curves)

1. Open a new Graphs page.
2. Tap **sin** and **x**, then tap **enter**.

- Tap \oplus .
- Tap **cos** and **x**, then tap **enter**.

For this example the graph now shows **f1(x)=sin(x)** and **f2(x)=cos(x)** function(s).

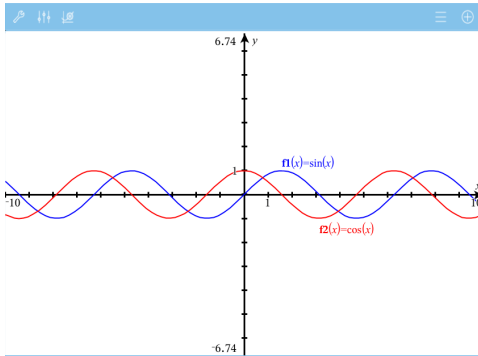

- Tap **Tools**  and go to **Analyze Graph > Bounded Area**.

The Bounded Area tool  appears in the application Toolbar. You are prompted to set the lower and upper bounds.

- Tap or drag two points to define the bounds.

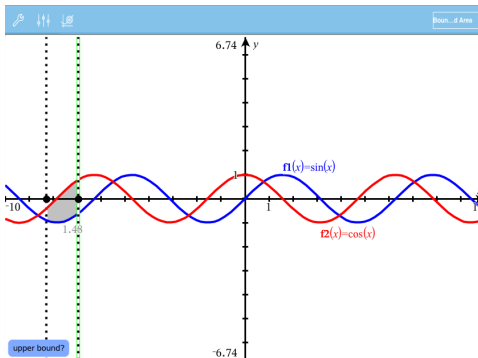

The area becomes shaded, and the area value is displayed. The value is always non-negative, regardless of the interval direction.

Working With Shaded Areas

As you change the bounds or redefine the curves, the shading and the area value are updated.

- To change the lower or upper bound, drag it or type new coordinates for it. You cannot move a bound that resides on an intersection. However, the point moves automatically as you edit or manipulate the curves.
- To redefine a curve, either manipulate it by dragging or edit its expression in the entry line.

Note: If an endpoint resided originally on an intersection, and the redefined functions no longer intersect, the shading and area value disappear. If you redefine the function(s) so that there is an intersection point, the shading and area value reappear.

- To delete or hide an area, tap to select the bounded area, then tap again to see the context menu. From the context menu, you may delete the bounded area.
- To change the color and other attributes, tap the Object Inspector once the shaded region is selected.

Displaying the Equation of a Geometric Object

You can display the equation of a geometric line, tangent line, circle shape, or geometric conic, provided the object was constructed in the Graphs application and can be converted faithfully to a template-based conic.

1. Tap the object to select it, and then tap it again to show its context menu.

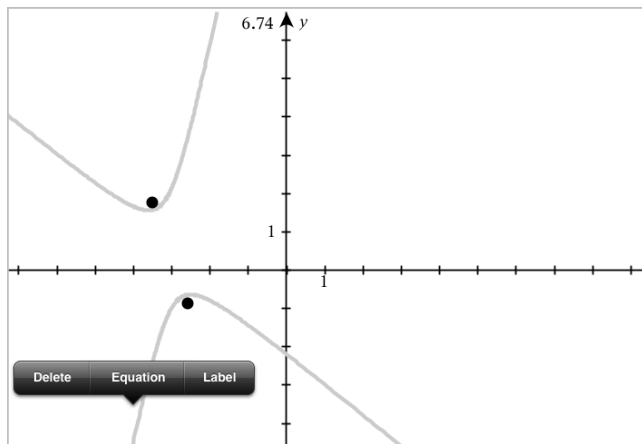

2. Tap **Equation** to display the equation as a Text object.

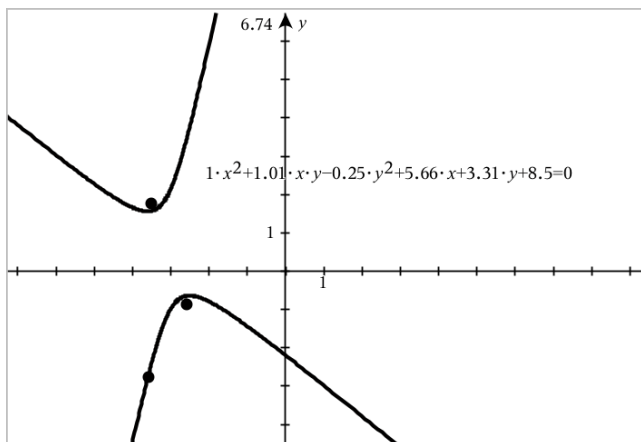

Using the Calculate Tool

The Calculate tool is available in the Graphs and Geometry applications. It lets you evaluate a math expression you have entered as a text object. You can edit an evaluated expression, and then re-evaluate it.

Entering the Expression

1. Tap **Tools**  and go to **Actions > Text**.
2. Tap the work area to place the text box and display the keyboard.
3. Type the expression, such as $(1/4)^2 \cdot 2$, and tap **enter**.

Note: Do not include variables in the expression.

$$\left(\frac{1}{4}\right)^2 \cdot 2$$

Calculating the Result

1. Tap **Tools**  and go to **Actions > Calculate**.

The Calculate tool appears in the toolbar, and a prompt asks you to select an expression to calculate.

2. Tap the text object to evaluate the expression.

$$\left(\frac{1}{4}\right)^2 \cdot 2 = \frac{1}{8}$$



Creating Shapes Using Gestures (MathDraw)

The MathDraw tool lets you use touchscreen gestures to create points, lines, circles, and other shapes.

- MathDraw is available in Geometry and Graphing.
- Graphing view when the x scale and y scale are identical. This avoids non-circular ellipses and non-square rectangles appearing as circles and squares.

Note: MathDraw is not available in the 3D Graphing.

Activating MathDraw

1. Tap **Add**, and then tap .
2. Tap **Tools** .
3. Tap **Actions** menu, select **MathDraw**.

The MathDraw tool  appears in the application Toolbar. You can begin using the tool.

Canceling MathDraw

▶ When you have finished using the MathDraw tool, tap the **X** on the tool.

Creating Points

To create a labeled point, tap in an open area.

- If the point is close to an existing line, segment, ray, geometric conic (including circles), or polygon, the point snaps to that object. You can also place a point on the intersection of any two of those types of objects.
- If the point is close to a visible grid location in a Graphs view or Geometry view, it snaps to the grid.

Drawing Lines and Segments

To create a line or segment, touch the initial position, and then drag to the end position.

- If the drawn line passes near an existing point, the line snaps to the point.
- If the drawn line starts close to an existing point and ends next to another existing point, it becomes a segment defined by those points.
- If the drawn line is nearly parallel or perpendicular to an existing line, segment, or side of a polygon, it aligns to that object.

Note: The default tolerance for detecting parallel/perpendicular lines is 12.5 degrees. This tolerance can be redefined using a variable named **ti_gg_fd.angle_tol**. You can change the tolerance in the current problem by setting this variable in the calculator app to a value in the range 0 through 45 (0=no parallel/perpendicular detection).

Drawing Circles and Ellipses

To create a circle or ellipse, use the touchscreen to draw the approximate shape.

- If the drawn shape is sufficiently circular, a circle is created.
- If the shape is elongated, an ellipse is created.
- If the virtual center of the drawn shape is near an existing point, the circle or ellipse is centered on that point.

Drawing Triangles

To create a triangle, draw a triangle-like shape.

- If a drawn vertex is close to an existing point, the vertex snaps to the point.

Drawing Rectangles and Squares

To create a rectangle or square, use the touchscreen to draw the perimeter.

- If the drawn shape is nearly square, a square is created.
- If the drawn shape is elongated, a rectangle is created.
- If the center of a square is close to an existing point, the square snaps to that point.

Drawing Polygons

To create a polygon, tap a succession of existing points, ending on the first point you tapped.

Using MathDraw to Create Equations

In the Graphs view, MathDraw attempts to recognize certain gestures as functions for analytic parabolas.

Note: The default step value for quantization of the parabola coefficients is $1/32$. The denominator of this fraction can be redefined using a variable named **ti_gg_fd.par_**

quant. You can change the step value in the current problem by setting this variable to a value greater or equal to 2. A value of 2, for example, produces a step value of 0.5.

Using MathDraw to Measure an Angle

To measure the angle between two existing lines, use the touchscreen to draw a circle arc from one of the lines to the other.

- If the intersection point between the two lines does not exist, it is created and labeled.
- The angle is not a directed angle.

Using MathDraw to Find a Mid-point

To create a point midway between two points, tap point 1, point 2, and then point 1 again.

Using MathDraw to Erase

To erase objects, use the touchscreen to drag left and right, similar to the motion of erasing a whiteboard.

- The erasure area is the bounding rectangle of the erasure gesture.
- All point objects and their dependents inside the erasure area are removed.

Sticky Tool in Geometry and Graphing

Sticky Tool is available in Geometry and Graphing.

Note: In the Graphs application, go to **Tools > Geometry**.

When a Geometry tool has the capability to remain active, it will display a lock element along with the tool icon.

Lock Element icon

Unlocked/Single-use icon



Locked/Multi-use icon



Note: All tools will open in the default or  unlocked/single-use state. The icon will appear to the left of the tool.

Unlocked/Single-use

Locked/Multi-use



Default State

Opening a tool will always be in the default unlocked/single-use state). This applies to scenarios like closing a tool, or switching to a new tool.

Geometry and Graphing tools that are sticky

The following tools will have the "sticky" feature:

- All items under "**Points & Lines**"
- All items under "**Shapes**"
- All items under "**Measurement**"
- All items under "**Construction**"
- All items under "**Transformation**"

Locking or Unlocking a tool

Tap the  unlocked/single-use icon to lock a tool for locked/multi-use.

Note: The tool is now in a  locked/multi-use state.

Tap the **X** to close the tool.

– OR –

Tap the  unlocked/single-use state.

Note: The user can also toggle between  icon.

3D Graphing

The 3D Graphing view lets you create and explore three-dimensional graphs.

What You Can Do

- Create and edit 3D functions of the form $z(x,y)$.
- Create and edit 3D parametric plots.
- Show and hide selected graphs.
- Set the background color and apply wire and surface colors to graphs.

Tools Search

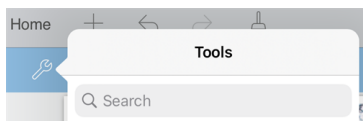

Tools Search allows you to search options and menus. It is available across all applications in the TI-Nspire™ App.

Warning: Tools Search will allow you to search for menu items, but not for command names.



Selecting the 3D Graphing View

The 3D Graphing View is available on any [Graphs page](#) .

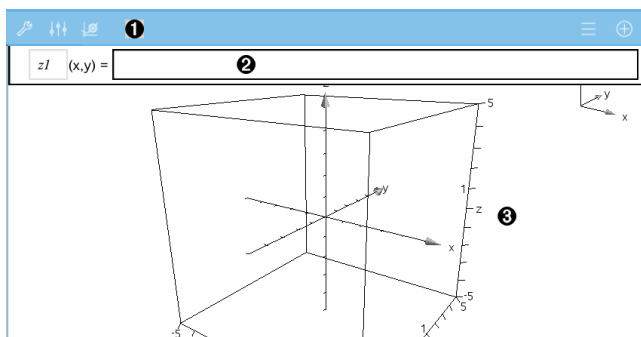
▶ Tap **Tools**  and go to **View > 3D Graphing**.



1 3D Graphs Toolbar

- Tap **Tools**  to create and explore 3D graphs.
- Tap **Inspector**  to change the appearance of a graph or the 3D box.

- Tap \equiv to view or edit an expression from the 3D graph history.

- Tap \oplus to hide or show the keyboard and the entry line.

② **Entry line.** Lets you define 3D graphs. The default graph type is 3D Function, indicated by $z/(x,y)=$.

③ **3D Graphs Work Area.** Shows a 3D box containing graphs that you define. Pinch to zoom the area, drag to rotate the box.

Graphing 3D Functions

1. In the [3D Graphing view](#), tap **Tools**  and go to **3D Graph Entry/Edit > Function**.

The keyboard and the entry line appear.

$z/$	$(x,y) =$	
------	-----------	--

2. Enter the expression that defines the graph. You can type the expression or build it using [expression templates](#).

$z/$	$(x,y) =$	$\frac{12 \cdot \cos\left(\frac{x^2+y^2}{4}\right)}{3+x^2+y^2}$
------	-----------	---

3. Tap **enter** to create the graph and hide the entry line and keyboard. You can show the entry line and keyboard anytime by tapping \oplus on the Graphs Toolbar.

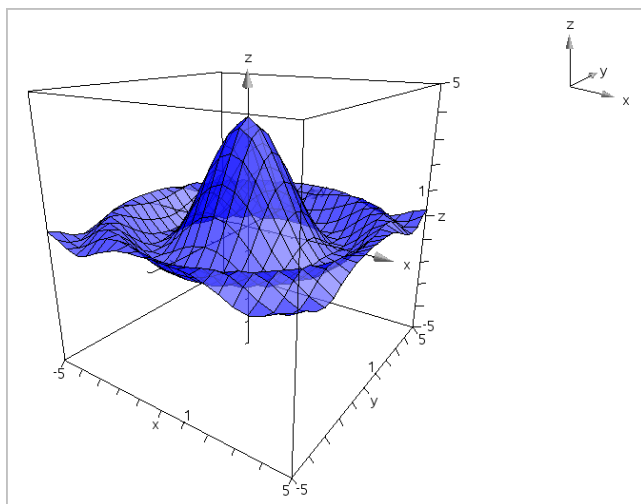

Graphing 3D Parametric Equations

1. In the [3D Graphing view](#), tap **Tools**  and go to **3D Graph Entry/Edit > Parametric**.

The keyboard and the entry line appear.

$xp1$	$(t,u) =$		
$yp1$	$(t,u) =$	<Enter expression>	
$zp1$	$(t,u) =$	<Enter expression>	

2. Type the equations that define the graph.

$xp1$	$(t,u) =$	$4 \cdot \cos(t) - \sin(u) \cdot \cos(t)$	
$yp1$	$(t,u) =$	$4 \cdot \sin(t) - \sin(u) \cdot \sin(t)$	
$zp1$	$(t,u) =$	$\cos(u)$	

3. (Optional) Tap  to set the 3D plotting parameters $tmin$, $tmax$, $umin$, and $umax$.

Cancel	3D Plot Parameters	OK
$tmin =$	<input type="text" value="0.0"/>	
$tmax =$	<input type="text" value="2*\pi"/>	
$umin =$	<input type="text" value="0.0"/>	
$umax =$	<input type="text" value="\pi"/>	

4. Tap **enter** to draw the graph and hide the entry line and keyboard. You can show the entry line and keyboard anytime by tapping  on the Graphs Toolbar.

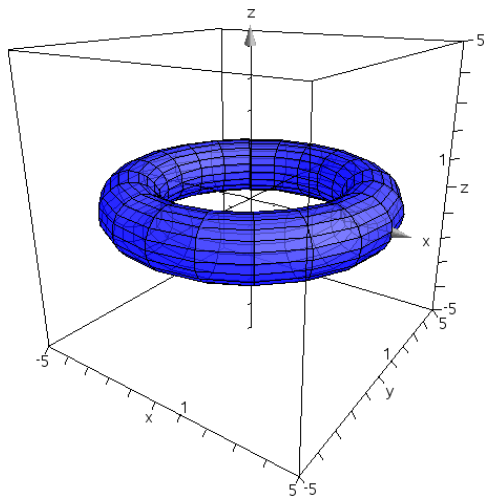

Zooming and Rotating the 3D View

Zooming

- ▶ Pinch the work area to zoom in or out.

Rotating Manually

- ▶ Drag in any direction to rotate all objects in 3D Graphing view.

Rotating Automatically

1. Tap **Tools**  and go to **Actions > Auto Rotation**.

The Auto Rotation tool  appears, and the graph rotates continuously around the z axis.

2. To stop the rotation, tap **X** on the tool.

Editing a 3D Graph

1. Double-tap the graph or its label to display the expression in the entry line. As an alternative, you can use the [graph history](#) to show the expression.

z1

(x,y) =

$$\frac{12 \cdot \cos\left(\frac{x^2+y^2}{4}\right)}{3+x^2+y^2}$$

2. Modify the existing expression, or type a new expression in the entry line.
3. Tap **enter** to draw the edited graph.

Changing the Appearance of a 3D Graph

1. Tap the graph to select it.
2. Tap **Inspector** $\downarrow \uparrow \downarrow$.



3. Select the items to change. Changes are applied as you select them.

Showing or Hiding a Graph's Label

1. Tap the graph to select it, and then tap it again to show its context menu.

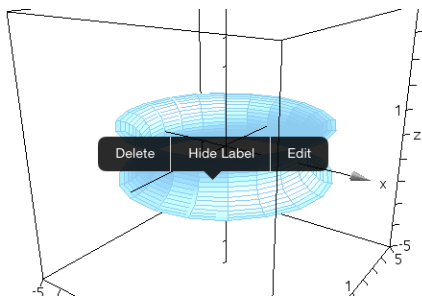

2. Tap **Hide Label** or **Show Label**.

Showing and Hiding 3D Graphs

1. In the [3D Graphing view](#), tap **Tools** \wedge and go to **Actions > Hide/Show**.

The Hide/Show tool  appears, and all hidden items are displayed in gray.

2. Tap a graph to change its hide/show state.
3. To apply the changes, tap **X** on the tool.

Note: If you want to show or hide only the graph's label, see [Showing or Hiding a Graph's Label](#).

Customizing the 3D Viewing Environment

Changing the Background Color

1. Tap the 3D box to select it.

Note: If the box is hidden, tap **Tools**  and go to **View > Show Box**.

2. Tap **Inspector** .
3. Tap **Fill Color**, and then select a color to apply it to the background.

Changing the 3D Projection

1. Tap the  and go to **View**.
2. Tap **Orthographic Projection** or **Perspective View**.

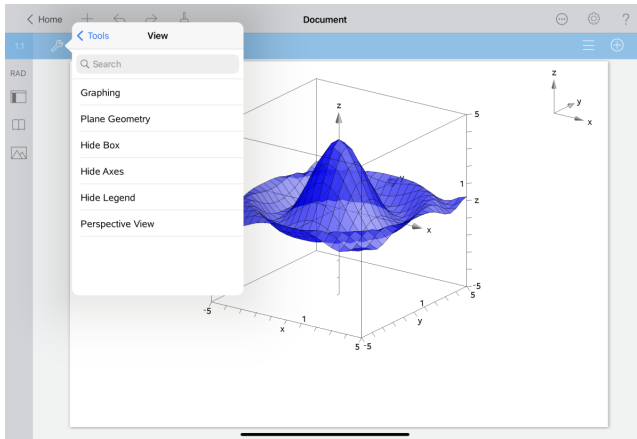

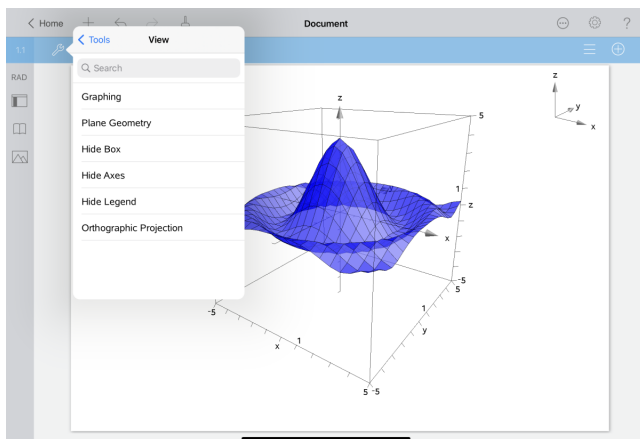

Showing or Hiding the Box, Axes, and Legend

1. Tap **Tools**  and go to **View**.
2. Tap the name of the element to show or hide.

Changing the 3D Aspect Ratio

1. Tap **Tools**  and go to **Range/Zoom > Aspect Ratio**.
2. Enter values for the x, y, and z axes. The default value for each axis is **1**.

Changing the Range of the 3D Box

- ▶ Tap **Tools**  and go to **Range/Zoom > Range Settings**.

Geometry Application

The Geometry application lets you create, manipulate, measure, transform, and animate geometric objects.

What You Can Do

- Create and explore points and lines, such as line segments, vectors, and circle arcs.
- Create and explore geometric shapes, such as circles, ellipses, polygons, and conics.
- Animate any point created as a point on an object or graph.
- Explore object transformations, including symmetry, reflection, translation, rotation, and dilation.
- Create geometric constructions, such as bisectors, parallels, perpendiculars, loci, and circles drawn with a compass.
- Hide an object or change its line color, line style, or fill color.
- Measure lengths, angles, perimeters, areas, and slopes.

Tools Search

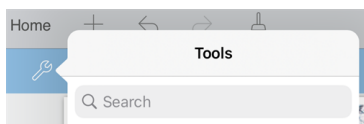

Tools Search allows you to search options and menus. It is available across all applications in the TI-Nspire™ App.

Warning: Tools Search will allow you to search for menu items, but not for command names.

What You Must Know

Finding Hidden Objects in the Graphs or Geometry Application

You can hide graphs, geometric objects, text, labels, measurements, and individual axis end-values.

To temporarily view hidden graphs or objects or to restore them as shown objects, tap **Tools**  and go to **Actions > Hide/Show**. Tap a graph or object to toggle its Hide/Show state.

Changing the Appearance of a Graph or Object

1. Tap the graph or object that you want to change.
2. Tap the **Inspector**  to display a list of the object's attributes.

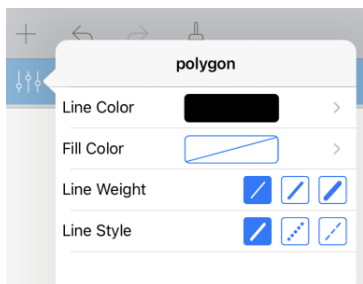

Note: The list of attributes is different for different types of objects.

3. Select the items to change. Changes are applied as you select them.

Animating a Point on a Graph or Object

1. Tap the point.
2. Tap **Inspector** $\phi \updownarrow \phi$ to display the point's attributes.

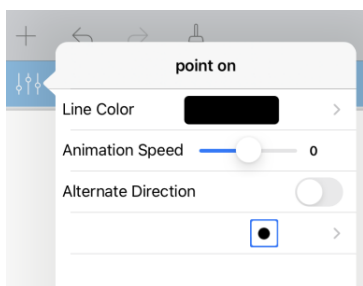



3. Drag the Animation Speed slider to set the speed and start the animation.

Inserting a Background Photo

The **Insert Photo**  tool lets you [insert a photo](#) as a background for any Graphs or Geometry page.

Adding Text to the Graphs or Geometry Work Area

1. Tap **Tools**  and go to **Actions > Text**.

The Text tool  appears in the application Toolbar.

2. Tap the location for the text.
3. Type the text in the box that appears, and then tap **return**.

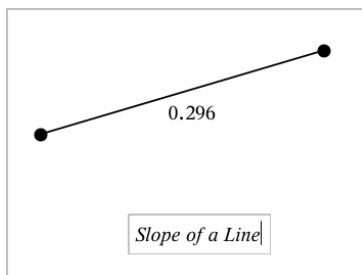

4. To edit the text, double-tap it.

Adding a Geometry Page

To get started with the Geometry application, add a Geometry page to an existing document.



Tap **Add**, and then tap .

A new Geometry page appears, showing the Geometry Toolbar and work area.



❶

Geometry Toolbar

- Tap **Tools**  to create and explore Geometry objects.
- Tap **Inspector**  to change the appearance of a selected item such as a geometric shape.
- Tap **Graphs & Geometry Settings**  to change the settings used by the Geometry and Graphs applications.

❷

Geometry work area. Geometry objects that you create are displayed here. Drag to pan the work area.

Introduction to Geometric Objects

Geometry tools are accessible in both the Graphs and Geometry applications. You can use these tools to draw and investigate objects such as points, lines, and shapes.

- The Graphing view shows the Graphs work area superimposed on the Geometry work area. You can select, measure, and alter objects in both work areas.
- The Plane Geometry view shows only the objects created in the Geometry application.

Objects Created in the Graphs Application

Points, lines, and shapes created in the Graphs application are analytic objects.

- All points that define these objects reside on the x,y graph plane. Objects created here are visible only in the Graphs application. Changing the axes scale affects the appearance of the objects.
- You can display and edit the coordinates of any point on an object.
- You can display the equation of a line, tangent line, circle shape, or geometric conic created in the Graphs application.

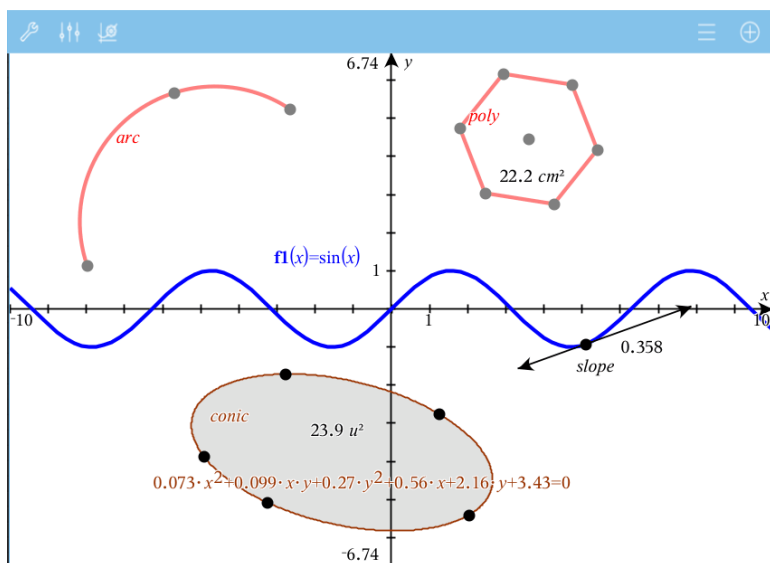

The circle arc and polygon were created in the Geometry application. The sine wave and conic were created in the Graphs application.

Objects Created in the Geometry Application

Points, lines, and shapes created in the Geometry application are not analytic objects.

- Points that define these objects do not reside on the graph plane. Objects created here are visible in both the Graphs and Geometry applications, but they are unaffected by changes to the Graphs x,y axes.
- You cannot obtain the coordinates of an object's points.
- You cannot display the equation of a geometric object created in the Geometry application

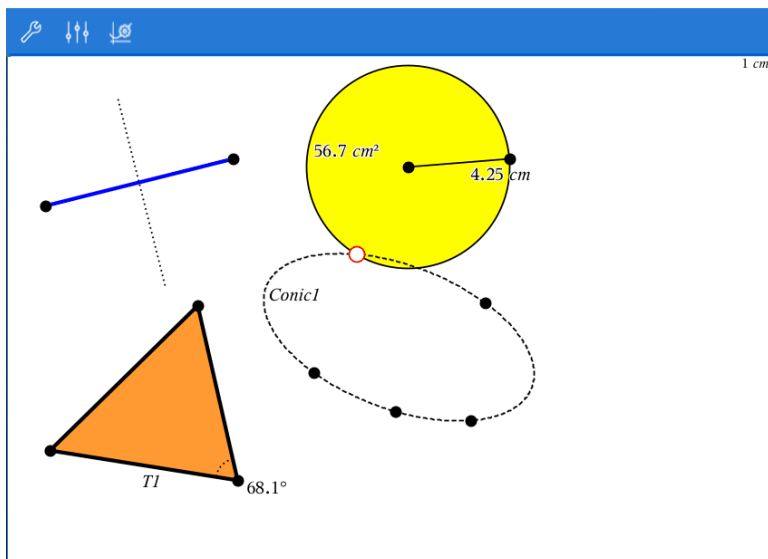



Creating Geometric Objects

You can create objects in both the Geometry and Graphs applications.



Creating Points and Lines

1. Tap **Tools** , select **Points and Lines**, and select the type of object, such as **Segment**. (In the Graphs application, go to **Geometry > Points and Lines > Segment**.)
2. Tap existing points or locations on the work area to define the object. For example, tap two objects when creating Intersection points.

As you create the object, a tool is shown in the application Toolbar (for example, **Segment**  Segment ). To cancel, tap the X on the tool.

Creating Geometric Shapes

1. Tap **Tools** , select **Shapes**, and select the type of object, such as **Polygon**. (In the Graphs application, go to **Geometry > Shapes > Polygon**.)
2. Tap existing points or locations on the work area to define the object. For example, tap two locations to define the center and radius of a circle.

As you create a shape, a tool is shown in the application Toolbar (for example, **Polygon**  **Polygon** ). To cancel the shape, tap the **X** on the tool.

Measuring and Transforming Geometric Objects

Measuring Objects

1. Tap **Tools** , select **Measurement**, and select the type of measurement, such as **Length**. (In the Graphs application, go to **Geometry > Measurement > Length**.)
2. Tap the object you want to measure.

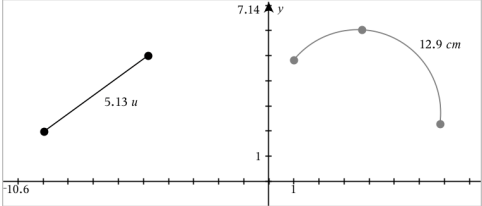
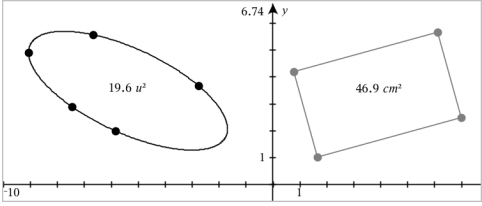
Measurement Type	Use to Measure...
<p>Length</p> 	<ul style="list-style-type: none">• Length of a segment, circle arc, or vector• Distance Between Two Points, a Point and a Line, or a Point and a Circle• Circumference of a Circle or Ellipse or the Perimeter of a Polygon, Rectangle, or Triangle• A side of a triangle, rectangle, or polygon. You must tap <i>two points</i> to measure a side. Tapping the side measures the entire length of the object's perimeter.
<p>Area</p> 	<p>Area of a Circle, Ellipse, Polygon, Rectangle, or Triangle</p>

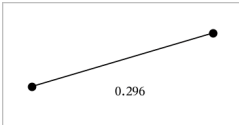
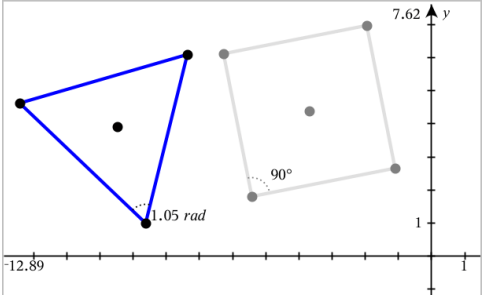
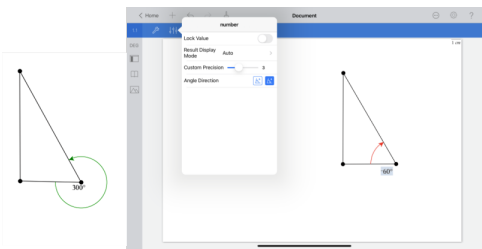

Measurement Type	Use to Measure...
<p>Slope</p> 	<p>Slope of a Line, Ray, Segment, or Vector</p>
<p>Angle</p> 	<p>Angles in the range from 0° to 180° (0 radians to π radians in the Graphs application)</p>
<p>Directed Angle</p> 	<p>Directed angles in the range from 0° to 360° (0 radians to 2π radians) and from -360° to 0° (-2π radians to 0 radians).</p>

Transforming Objects

1. Tap **Tools** , select **Transformation**, and select the type of transformation, such as **Symmetry**. (In the Graphs application, go to **Geometry** > **Transformation** > **Symmetry**.)
2. Tap the object you want to transform.
3. Tap a location, existing point, or other object to create the transformation.

Exploring with Construction Tools

To add a construction, tap **Tools** , select **Construction**, and select the type of construction, such as **Parallel**. (In the Graphs application, go to **Geometry** > **Construction** > **Parallel**.)

While a construction is in progress, a tool appears in the application Toolbar (for example, **Parallel**  **Parallel** ). To cancel, tap the X on the tool.

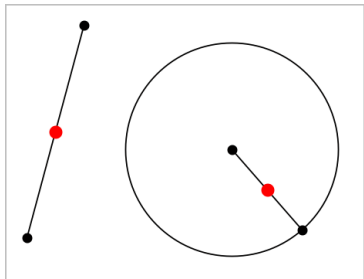
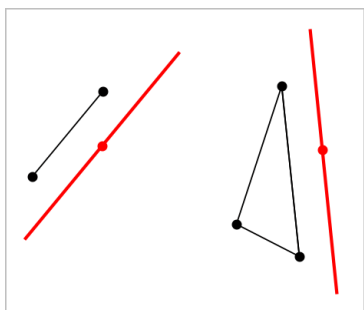
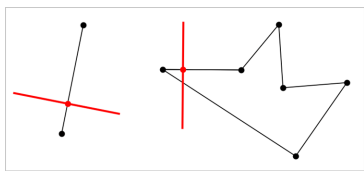
Construction Type	Description
<p>Midpoint</p> 	<p>Bisects a segment or sets a midpoint between any two points. The points can be on a single object, on separate objects, or on the work area.</p>
<p>Parallel Line</p> 	<p>Creates a parallel line with respect to any existing line. The existing line can be a Graphs axis or any side of a triangle, square, rectangle, or polygon.</p>
<p>Perpendicular Line</p> 	<p>Creates a line that is perpendicular to a reference line. The reference can be an axis, an existing line, a segment, or one side of a triangle, rectangle, or polygon.</p>
<p>Perpendicular Bisector</p>	<p>Creates a perpendicular bisector on a segment, on one side of a triangle, rectangle, or polygon, or between any two points.</p>

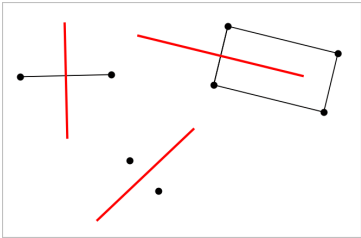
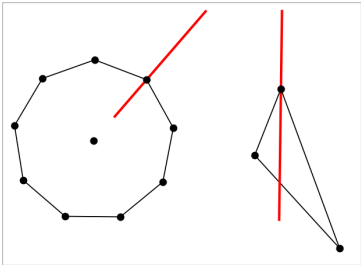
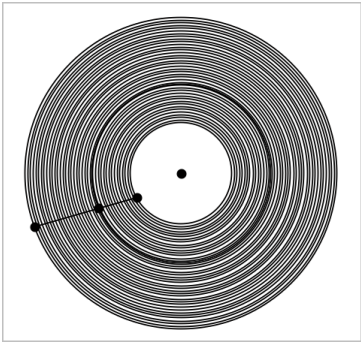
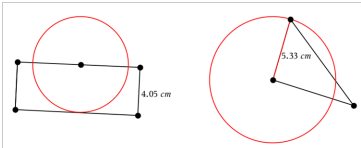
Construction Type	Description
	
<p data-bbox="91 393 228 417">Angle Bisector</p> 	<p data-bbox="526 393 907 471">Creates an angle bisector. The points of the angle can be on existing objects, or they can be locations on the work area.</p>
<p data-bbox="91 722 146 746">Locus</p> 	<p data-bbox="526 722 928 801">Lets you explore the range of motion of one object with respect to another object as constrained by a shared point.</p>
<p data-bbox="91 1130 177 1154">Compass</p> 	<p data-bbox="526 1130 938 1177">Operates similarly to a geometric compass used for drawing circles on paper.</p>

Using the Calculate Tool

The Calculate tool is available in the Graphs and Geometry applications. It lets you evaluate a math expression you have entered as a text object. You can edit an evaluated expression, and then re-evaluate it.

Entering the Expression

1. Tap **Tools**  and go to **Actions > Text**.
2. Tap the work area to place the text box and display the keyboard.
3. Type the expression, such as $(1/4)^2 \cdot 2$, and tap **enter**.

Note: Do not include variables in the expression.

$$\left(\frac{1}{4}\right)^2 \cdot 2$$

Calculating the Result

1. Tap **Tools**  and go to **Actions > Calculate**.

The Calculate tool appears in the toolbar, and a prompt asks you to select an expression to calculate.

2. Tap the text object to evaluate the expression.

$$\left(\frac{1}{4}\right)^2 \cdot 2 = \frac{1}{8}$$



Creating Shapes Using Gestures (MathDraw)

The MathDraw tool lets you use touchscreen gestures to create points, lines, circles, and other shapes.

- MathDraw is available in Geometry and Graphing.
- Graphing view when the x scale and y scale are identical. This avoids non-circular ellipses and non-square rectangles appearing as circles and squares.

Note: MathDraw is not available in the 3D Graphing.

Activating MathDraw

1. Tap **Add**, and then tap .
2. Tap **Tools** .
3. Tap **Actions** menu, select **MathDraw**.

The MathDraw tool  appears in the application Toolbar. You can begin using the tool.

Canceling MathDraw

- ▶ When you have finished using the MathDraw tool, tap the **X** on the tool.

Creating Points

To create a labeled point, tap in an open area.

- If the point is close to an existing line, segment, ray, geometric conic (including circles), or polygon, the point snaps to that object. You can also place a point on the intersection of any two of those types of objects.
- If the point is close to a visible grid location in a Graphs view or Geometry view, it snaps to the grid.

Drawing Lines and Segments

To create a line or segment, touch the initial position, and then drag to the end position.

- If the drawn line passes near an existing point, the line snaps to the point.
- If the drawn line starts close to an existing point and ends next to another existing point, it becomes a segment defined by those points.
- If the drawn line is nearly parallel or perpendicular to an existing line, segment, or side of a polygon, it aligns to that object.

Note: The default tolerance for detecting parallel/perpendicular lines is 12.5 degrees. This tolerance can be redefined using a variable named **ti_gg_fd.angle_tol**. You can change the tolerance in the current problem by setting this variable in the calculator app to a value in the range 0 through 45 (0=no parallel/perpendicular detection).

Drawing Circles and Ellipses

To create a circle or ellipse, use the touchscreen to draw the approximate shape.

- If the drawn shape is sufficiently circular, a circle is created.
- If the shape is elongated, an ellipse is created.
- If the virtual center of the drawn shape is near an existing point, the circle or ellipse is centered on that point.

Drawing Triangles

To create a triangle, draw a triangle-like shape.

- If a drawn vertex is close to an existing point, the vertex snaps to the point.

Drawing Rectangles and Squares

To create a rectangle or square, use the touchscreen to draw the perimeter.

- If the drawn shape is nearly square, a square is created.
- If the drawn shape is elongated, a rectangle is created.
- If the center of a square is close to an existing point, the square snaps to that point.

Drawing Polygons

To create a polygon, tap a succession of existing points, ending on the first point you tapped.

Using MathDraw to Create Equations

In the Graphs view, MathDraw attempts to recognize certain gestures as functions for analytic parabolas.

Note: The default step value for quantization of the parabola coefficients is $1/32$. The denominator of this fraction can be redefined using a variable named `ti_gg_fd.par_quant`. You can change the step value in the current problem by setting this variable to a value greater or equal to 2. A value of 2, for example, produces a step value of 0.5.

Using MathDraw to Measure an Angle

To measure the angle between two existing lines, use the touchscreen to draw a circle arc from one of the lines to the other.

- If the intersection point between the two lines does not exist, it is created and labeled.
- The angle is not a directed angle.

Using MathDraw to Find a Mid-point

To create a point midway between two points, tap point 1, point 2, and then point 1 again.

Using MathDraw to Erase

To erase objects, use the touchscreen to drag left and right, similar to the motion of erasing a whiteboard.

- The erasure area is the bounding rectangle of the erasure gesture.
- All point objects and their dependents inside the erasure area are removed.

Sticky Tool in Geometry and Graphing

Sticky Tool is available in Geometry and Graphing.

Note: In the Graphs application, go to **Tools > Geometry**.

When a Geometry tool has the capability to remain active, it will display a lock element along with the tool icon.

Lock Element icon

Unlocked/Single-use icon



Locked/Multi-use icon



Note: All tools will open in the default or  unlocked/single-use state. The icon will appear to the left of the tool.

Unlocked/Single-use



Locked/Multi-use



Default State

Opening a tool will always be in the default unlocked/single-use state). This applies to scenarios like closing a tool, or switching to a new tool.

Geometry and Graphing tools that are sticky

The following tools will have the "sticky" feature:

- All items under "**Points & Lines**"
- All items under "**Shapes**"
- All items under "**Measurement**"
- All items under "**Construction**"
- All items under "**Transformation**"

Locking or Unlocking a tool

Tap the  unlocked/single-use icon to lock a tool for locked/multi-use.

Note: The tool is now in a  locked/multi-use state.

Tap the **X** to close the tool.

– OR –

Tap the  unlocked/single-use state.

Note: The user can also toggle between  icon.

Lists & Spreadsheet Application

The Lists & Spreadsheet application provides a place to work with tabular data.

What You Can Do

- Define a column based on the contents of another column.
- Work with variables created in the Graphs & Geometry and Calculator applications.
- Plot table data using the Data & Statistics application.
- Generate a table of values for a function or plot.
- Perform statistical analysis on lists of data.

Tools Search

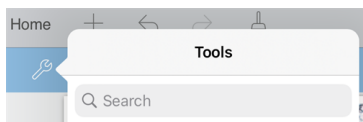

Tools Search allows you to search options and menus. It is available across all applications in the TI-Nspire™ App.

Warning: Tools Search will allow you to search for menu items, but not for command names.

What You Must Know

Typing a Cell Reference in a Formula

Absolute references include the \$ symbol before the column letter and before the row number, and always refer to the cell in a specific position in the spreadsheet. Relative references include only the cell's column letter and row number, and describe where a cell is in relation to other cells of the spreadsheet.

1. Double-tap the cell, and type the formula.
2. Move to the appropriate position in the formula, and type the cell reference.

Use the format for a relative reference (B3), absolute reference (\$B\$2), or range of cells (A1:A4).

Linking a Cell Value to a Variable

1. In a Lists & Spreadsheet page, tap the cell that you want to link to a variable, and then tap the cell again to open the context menu.
2. Tap **Link**, and then tap the name of the variable to insert it into the cell.

Linking a Column to a Variable

1. Tap the column formula cell (the second cell from the top) that you want to link to a variable.
2. Type the name of the list variable that you want to link to, and then tap **return**.

Note: To view a list of available variables, tap **var** on the TI-Nspire™ Keyboard.

Adding a Lists & Spreadsheet Page

To get started with the Lists & Spreadsheet application, add a Lists & Spreadsheet page to an existing document.

- Tap **Add**, and then tap .

A blank Lists & Spreadsheet page is displayed.

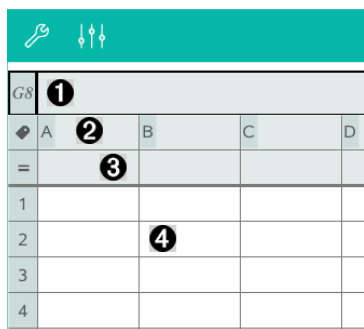

G8	1			
A	2	B	C	D
=	3			
1				
2		4		
3				
4				

- 1 Column and row reference cell
- 2 Column name cell for defining a column as a list variable
- 3 Column formula cell for generating a column of data
- 4 Body cells

Working with Data

Generating Columns of Data

You can create a column of values based on the contents of another column or on any of several types of sequential data.

D	=seqgen(n+2,n,u,{2,30},{1},3)			
A	B ❶	C ❷	D ❸	
=		=xbar^2	=a[]/2	=seqgen(n)
1	1	25	1/2	1
2	5	25	5/2	7
3	5	25	5/2	10
4	45	25	45/2	13
5	7	25	7/2	16

- ❶ Column formula based on a variable
- ❷ Column formula based on another column
- ❸ Column formula that generates a sequence

Creating Values Based on Another Column

1. Tap the column formula cell (the second cell from the top) of the column where you want to use a formula.
2. Type the expression for the formula after the = and tap **enter**.

Note: Use brackets ([]) after any column letter you include in the formula.

Generating a Column of Random Numbers

1. Tap the column formula cell (the second cell from the top) of the column.
2. Tap **Tools**  and go to **Data > Random > Integer** to insert the **randint()** function.
3. The app inserts the **randint()** function in the formula cell.
4. Type **1, 6, 20**, and then tap **enter**.

Note: The numbers given are for illustrative purposes only, and will generate a column of 20 random integers in the range, 1 through 6.

Generating a Numerical Sequence

1. Tap any cell in the column in which you want to generate the sequence.
2. Tap **Tools**  and go to **Data > Generate Sequence**.
3. Type the **Formula** that will be applied to the column values.

4. Type any starting numbers required by the sequence in the **Initial Terms** field and separate them with commas.
5. Type a starting value for the independent variable (**n0**), a maximum number of values to be generated (**nMax**), and the step value (**nStep**).

Note: Type a maximum value for the sequence in the **Ceiling Value** field, if desired.

6. Tap **OK**.

Graphing Spreadsheet Data

Creating a Scatter Plot with Quick Graph

1. Name both of the columns to declare them as lists, and then select both columns.
2. Tap **Tools**  and go to **Data > Quick Graph**.

A Data & Statistics application is added to the page with the plotted data.

Creating a Summary Plot

Note: In this example, you create a summary table from raw data, and then use the table to generate a summary plot.

1. Create a list that holds the category identifiers. For this example, name the list “color” and type strings for eye color.
2. Create the summary list. For this example, name the list “counts” and type the total count for each of the eye colors.
3. Select either list.
4. Tap **Tools**  and go to **Data > Summary Plot**.
5. If necessary, change the lists for X List and Summary List.
6. In the **Display On** field, select how to display the summary plot in the Data & Statistics application, and then tap **OK**.

Capturing Data from Graphs or Geometry

1. Clear the columns you plan to use for the captured data.
2. Ensure that the data values you want to capture are linked to variable names.
3. Tap the column formula cell (the second cell from the top) of the column in which you want to capture the values.
4. Tap **Tools**  and go to **Data > Data Capture > Automatic**.

A capture expression is inserted.

5. Replace the letters “var” with the name of the variable to capture.

Note: You can also select the variable name from the Variables menu by tapping **var**, and then tapping the desired variable.

Using Table Data for Statistical Analysis

Tools on the Statistics menu provide access to wizards that help you perform statistical analyses on the data in table columns. You specify the location of the data, and the Lists & Spreadsheet application stores the results in two columns: one for the result names, and one for the corresponding values.

Cancel	z Test	OK
μ_0 :	<input type="text" value="Input your value"/>	
σ :	<input type="text" value="Input your value"/>	
\bar{x} :	<input type="text" value="Input your value"/>	
n:	<input type="text" value="Input your value"/>	
Alternate Hyp:	<input type="text" value="Ha: <math>\mu \neq \mu_0</math>"/> >	
1st Result Column:	<input type="text" value="b[]"/>	
Draw:	Shade P <input checked="" type="checkbox"/>	

Statistical Calculations and Results

You can perform statistical calculations to analyze data.

Performing Statistical Calculations

Note: The following example fits a $y=mx+b$ linear regression model to two lists.

1. Tap the column formula cell (second cell from the top) in column A.
2. Tap **Tools**  and go to **Statistics > Stat Calculations > Linear Regression (mx+b)** to choose the regression model.

- Tap \triangleright next to the Y List box to display a named list. Tap the name of the list for the Y List.
- To store the regression equation in a specified variable, replace **Save RegEqn To** with the name of the variable.
- Tap the **1st Result Column** box and type $c[]$ as the column letter for the first result column.
- Tap **OK**.

D1	="Linear Regression (mx+b)"			
A	B ylist	C	D	E
=			=LinRegMx	
1	55	11	Title	Linear Re...
2	23	20	RegEqn	$m*x+b$
3	78	8	m	-0.073313
4	15	10	b	16.231
5	63	15	r^2	0.170525
6			r	-0.412947
7			Resid	{-1.1988...

Note: The results are linked to the source data.

Storing Statistical Results

The Lists & Spreadsheet application stores statistical results using a variable-group name with the format `stat.nnn`, where *nnn* is the result name (for example, `stat.RegEqn` and `stat.Resid`). If you want to use a custom variable group instead of the standard name, edit the formula in the column formula cell. You could use the following formula to store the results in the variable group **MystatsB**.

`=LinRegMx(a[],b[],1): CopyVar Stat., MystatsB.`

Later, you could view the results by entering the following expression in the Calculator application or in another column of the Lists & Spreadsheet application:

`MystatsB.results`

Distributions

Calculating a Distribution

Example: Calculate a distribution to fit the Normal Pdf distribution model.

- Enter the X values of the data in column A.

2. Tap the top cell of column A and enter a name, such as **DD1**, for the X values.
3. Tap the column formula cell (second cell from the top) in column B.
4. Tap **Tools**  and go to **Statistics > Distributions > Normal Pdf**.

The Normal Pdf dialog box opens and displays fields for entering the arguments for the calculation.

5. Tap each field and provide:
 - **X Value:** To use the list that you defined in step 2, tap the arrow and select the list name.
 - **Mean (μ):** Type a value or select a variable that contains the mean.
 - **Standard Deviation (σ):** Type a value or select a variable that contains the standard deviation.
6. (Optional) Select the **Draw** option to see the distribution plotted in Data & Statistics.

Note: The Draw option is not available for all distributions.

7. Tap **OK**.

Lists & Spreadsheet populates column B with the results. The results are plotted in Data & Statistics.

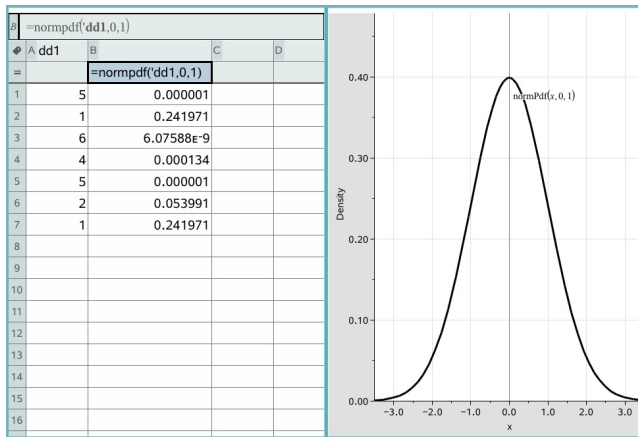

Note: The results are linked to the source data. For example, if you change a value in Column A, the result updates automatically.

Supported Distribution Functions

The following distributions are available from the Lists & Spreadsheet application. For more information regarding these functions, see the *TI-Nspire™ Reference Guide*.

- To return a single distribution result based on a single value, type the function in a single cell.
- To return a list of distribution results based on a list of values, type the function in a column formula cell. In this case, you specify a list (column) that contains the values. For each value in the list, the distribution returns a corresponding result.

Note: For distribution functions that support the draw option (**normPDF**, **t PDF**, χ^2 **Pdf**, and **F Pdf**), the option is available only if you type the distribution function in a formula cell.

Normal Pdf (normPdf)

Computes the probability density function (**pdf**) for the normal distribution at a specified x value. The defaults are mean $\mu=0$ and standard deviation $\sigma=1$. The probability density function (pdf) is:

$$f(x) = \frac{1}{\sqrt{2\pi}\sigma} e^{-\frac{(x-\mu)^2}{2\sigma^2}}, \sigma > 0$$

This distribution is used to determine the probability of the occurrence of a certain value in a normal distribution. The draw option is available when Normal PDF is invoked from a formula cell.

When you access distributions from the formula cell, you must select a valid list from the drop-down list to avoid unexpected results. If accessed from a cell, you must specify a number for the x -value. The distribution returns the probability that the value you specify will occur.

Normal Cdf (normCdf)

Computes the normal distribution probability between *Lower Bound* and *Upper Bound* for the specified mean, μ (default=0) and the standard deviation, σ (default=1). You can click the **Draw (Shade area)** check box to shade the area between the lower and upper bounds. Changes to the initial *Lower Bound* and *Upper Bound* automatically update the distribution.

This distribution is useful in determining the probability of an occurrence of any value between the lower and upper bounds in the normal distribution. It is equivalent to finding the area under the specified normal curve between the bounds.

Inverse Normal (invNorm)

Computes the inverse cumulative normal distribution function for a given *area* under the normal distribution curve specified by mean, μ , and standard deviation, σ .

This distribution is useful in determining the x-value of data in the area from 0 to $x < 1$ when the percentile is known.

t Pdf (tPdf)

Computes the probability density function (**pdf**) for the t-distribution at a specified *x* value. *df* (degrees of freedom) must be > 0 . The probability density function (**pdf**) is:

$$f(x) = \frac{\Gamma[(df+1)/2]}{\Gamma(df/2)} \frac{(1+x^2/df)^{-(df+1)/2}}{\sqrt{\pi df}}$$

This distribution is useful in determining the probability of the occurrence of a value when the population standard deviation is not known and the sample size is small. The draw option is available when **t Pdf** is invoked from a formula cell.

t Cdf (tCdf)

Computes the Student-t distribution probability between *Lower Bound* and *Upper Bound* for the specified *df* (degrees of freedom). You can click the **Draw (Shade area)** check box to shade the area between the bounds. Changes to the initial *Lower Bound* and *Upper Bound* automatically update the distribution.

This distribution is useful in determining the probability of the occurrence of a value within an interval defined by the lower and upper bound for a normally distributed population when the population standard deviation is not known.

Inverse t (invt)

Computes the inverse cumulative t-distribution probability function specified by Degrees of Freedom, *df*, for a given area under the curve.

This distribution is useful in determining the probability of an occurrence of data in the area from 0 to $x < 1$. This function is used when the population mean and/or population standard deviation is not known.

χ^2 Pdf (χ^2 Pdf())

Computes the probability density function (**pdf**) for the χ^2 (chi-square) distribution at a specified x value. df (degrees of freedom) must be an integer > 0 . The probability density function (**pdf**) is:

$$f(x) = \frac{1}{\Gamma(df/2)} (1/2)^{df/2} x^{df/2-1} e^{-x/2} \quad x \geq 0$$

This distribution is useful in determining the probability of the occurrence of a given value from a population with a χ^2 distribution. The draw option is available when χ^2 Pdf is invoked from a formula cell.

χ^2 Cdf (χ^2 Cdf())

Computes the χ^2 (chi-square) distribution probability between *lowBound* and *upBound* for the specified df (degrees of freedom). You can click the **Draw Shade area** check box to shade the area between the lower and upper bounds. Changes to the initial *lowBound* and *upBound* automatically update the distribution.

This distribution is useful in determining the probability of the occurrence of value within given boundaries of a population with a χ^2 distribution.

F Pdf (F Pdf())

Computes the probability density function (**pdf**) for the F distribution at a specified x value. *numerator df* (degrees of freedom) and *denominator df* must be integers > 0 . The probability density function (**pdf**) is:

$$f(x) = \frac{\Gamma[(n+d)/2]}{\Gamma(n/2)\Gamma(d/2)} \left(\frac{n}{d}\right)^{n/2} x^{n/2-1} (1+nx/d)^{-(n+d)/2} \quad x \geq 0$$

where n = numerator degrees of freedom
 d = denominator degrees of freedom

This distribution is useful in determining the probability that two samples have the same variance. The draw option is available when F Pdf is invoked from a formula cell.

F Cdf (F Cdf())

Computes the F distribution probability between *lowBound* and *upBound* for the specified *dfNumer* (degrees of freedom) and *dfDenom*. You can click the **Draw (Shade area)** check box to shade the area between the lower and upper bounds. Changes to the initial *lowBound* and *upBound* automatically update the distribution.

This distribution is useful in determining the probability that a single observation falls within the range between the lower bound and upper bound.

Binomial Pdf (binomPdf())

Computes a probability at x for the discrete binomial distribution with the specified *numtrials* and probability of success (p) on each trial. The x parameter can be an integer or a list of integers. $0 \leq p \leq 1$ must be true. *numtrials* must be an integer > 0 . If you do not specify x , a list of probabilities from 0 to *numtrials* is returned. The probability density function (**pdf**) is:

$$f(x) = \binom{n}{x} p^x (1-p)^{n-x}, x = 0, 1, \dots, n$$

where $n = \text{numtrials}$

This distribution is useful in determining the probability of success in a success/failure trial, at trial n . For example, you could use this distribution to predict the probability of getting heads in a coin toss on the fifth toss.

Binomial Cdf (binomCdf())

Computes a cumulative probability for the discrete binomial distribution with n number of trials and probability p of success on each trial.

This distribution is useful in determining the probability of a success on one trial before all trials are completed. For example, if heads is a successful coin toss and you plan to toss the coin 10 times, this distribution would predict the chance of obtaining heads at least once in the 10 tosses.

Inverse Binomial (invBinom())

Given the number of trials (*NumTrials*) and the probability of success of each trial (*Prob*), this function returns the minimum number of successes, k , such that the value, k , is greater than or equal to the given cumulative probability (*CumulativeProb*).

This distribution is useful in determining the upper bound input of the binomial cdf. For example, if you flip a coin 10 times, and you want the probability of getting x heads or less to be greater than 75%, this distribution will help determine what x should be.

Inverse Binomial with respect to N (invBinomN())

Given the probability of success of each trial (*Prob*), and the number of successes (*NumSuccess*), this function returns the minimum number of trials, N , such that the value, N , is less than or equal to the given cumulative probability (*CumulativeProb*).

This distribution is useful in determining the number of trials of the binomial cdf. For example, if you flip a coin several times and you want the number of heads to be 6 or less with a probability of less than 25%, this distribution will help determine how many times to flip the coin.

Poisson Pdf (poissPdf())

Computes a probability at x for the discrete Poisson distribution with the specified mean, μ , which must be a real number > 0 . x can be an integer or a list of integers. The probability density function (pdf) is:

$$f(x) = e^{-\mu} \mu^x / x!, x = 0, 1, 2, \dots$$

This distribution is useful in determining the probability of obtaining a certain number of successes before a trial begins. For example, you could use this calculation to predict the number of heads that would occur in eight tosses of a coin.

Poisson Cdf (poissCdf())

Computes a cumulative probability for the discrete Poisson distribution with specified mean, \bar{x} .

This distribution is useful in determining the probability that a certain number of successes occur between the upper and lower bounds of a trial. For example, you could use this calculation to predict the number of heads displayed between coin toss #3 and toss #8.

Geometric Pdf (geomPdf())

Computes a probability at x , the number of the trial on which the first success occurs, for the discrete geometric distribution with the specified probability of success p . $0 \leq p \leq 1$ must be true. x can be an integer or a list of integers. The probability density function (pdf) is:

$$f(x) = p(1-p)^{x-1}, x = 1, 2, \dots$$

This distribution is useful in determining the likeliest number of trials before a success is obtained. For example, you could use this calculation to predict the number of coin tosses that would be made before a heads resulted.

Geometric Cdf (geomCdf())

Computes a cumulative geometric probability from lowBound to upBound with the specified probability of success, p .

This distribution is useful in determining the probability associated with the first success occurring during trials 1 through n . For example, you could use this calculation to determine the probability that heads display on toss #1, #2, #3, ..., # n .

Working with Tables

You can change the table of plots values using the tools on the **Table** menu.

- ▶ To remove a column from the table, click any cell, and then tap **Tools**  and go to **Table > Delete Column**.
- ▶ To display the list of plots, tap the drop-down arrow on the top cell of a column. Select an empty column, (unless you are replacing values already displayed), and then tap a function in the list to add its values to the column.
- ▶ To change the expression that defines a plot, tap the formula cell and edit the expression.

Manual Data Capture

You can use Lists & Spreadsheet application to capture information about objects in the TI-Nspire™ Apps for iPad®. For example, you could track changes of the position of a point on a graph in the Graphs & Geometry application.

The ability to capture data manually is not limited to Graphs & Geometry. This function could work for any other application in the same problem.

Capturing Data Manually

1. Tap the column formula cell (the second cell from the top) of the column in which you want to capture the values.

Note: Captured values replace values in the column.

2. Tap **Tools**  and go to **Data > Data Capture > Manual**.

A capture expression is inserted into the column formula cell with "var" as a placeholder for the name of the variable you are capturing.



A $=capture(a,0)$

Note: The argument “0” tells Lists & Spreadsheet that you want to trigger each capture manually.

4. Tap **enter**.
5. From the Graphs & Geometry application, move the point to a different location where x coordinate of the point is stored in a variable (a , in this example) referenced in the data capture expression.

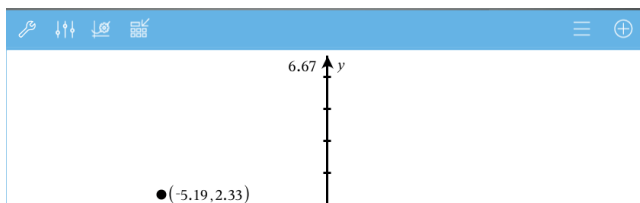

6. Tap .

The current a value is stored in the Lists & Spreadsheet application configured to capture the variable a .

The figure shows a screenshot of the Lists & Spreadsheet application. The interface has a teal header bar with icons for settings, capture, and data capture. Below the header is a table with columns A through I and rows 1 through 12. The formula bar at the top shows $=capture(a,0)$. The value -5.1962 is displayed in cell A1.

	A	B	C	D	E	F	G	H	I
12									
	$=capture(a,0)$								
1	-5.1962								

See [Using Variables](#) for more information on adding and using variables.

Data & Statistics Application

The Data & Statistics Application enables teachers and students to create graphical displays and perform analysis on data stored in lists. Defining (or naming) sets of data using the Lists & Spreadsheet Application is the starting point for plotting and analyzing data.

What You Can Do

- Work with sets of data in different types of plots.
- Work with sets of data in different types of charts.
- Manipulate variables to explore and visualize data relationships.
- Explore central tendency and other statistical summary techniques.
- Fit functions to data.
- Create regression lines for scatter plots.
- Graph hypothesis tests and results (z- and t-tests) based on summary statistics definitions or data.

Tools Search

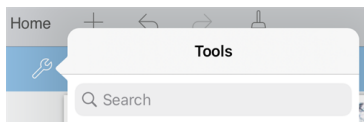

Tools Search allows you to search options and menus. It is available across all applications in the TI-Nspire™ App.

Warning: Tools Search will allow you to search for menu items, but not for command names.

What You Must Know

Plotting Variables

- Lists created in Lists & Spreadsheet can be accessed as a variable.
- Variables must be named before they can be used in Data & Statistics.
- Tap the **Add Variable** field located in the center of the x-axis or y-axis to choose a defined variable name.
- The default plot for one variable is a dot chart. The data points in the default caseplot reposition to represent the elements of the selected variable.
- The default plot for two variables is a scatter plot. The data points shift to represent the elements of both variables on a scatter plot.

Rescaling the Axes

Pinch or spread either the horizontal or vertical axis to modify its scale.

– OR –

Drag either axis to shift the axis while retaining its scale.

To restore the original size and location of the plotted data, tap **Tools > Window/Zoom > Zoom-Data**.

Plotting a Value

When you plot a value on an existing plot, it is displayed as a vertical line in the work area. You can plot a single number or any expression that evaluates to a number. If the value is dependent on the data, the line updates to reflect changes made when you drag a point or make changes in the Lists & Spreadsheet application. The plotted value must be in the domain of the axis.

To plot a value:

1. Tap **Tools** , go to **Analyze**, and then tap **Plot Value**.
2. Type the value you want to plot, and then tap **enter**.

Plotting a Function

Use Plot Function to graph a function for comparison to an existing plot. To plot a function:

1. Create or open a problem that includes variables that are plotted in a Data & Statistics work area. Ensure the work area contains both a horizontal axis and a vertical axis.
2. Tap **Tools** , go to **Analyze**, and then tap **Plot Function**.
3. Type the function in the entry field and tap **return**.

Note: You can rename the function by typing over **f1(x)**: with another name.

Adding a Data & Statistics Page

To get started with the Data & Statistics application, add a Data & Statistics page to an existing document that contains a Lists & Spreadsheet page.

1. Tap **Add**, and then tap .

The Data & Statistics page shows the default case plot.

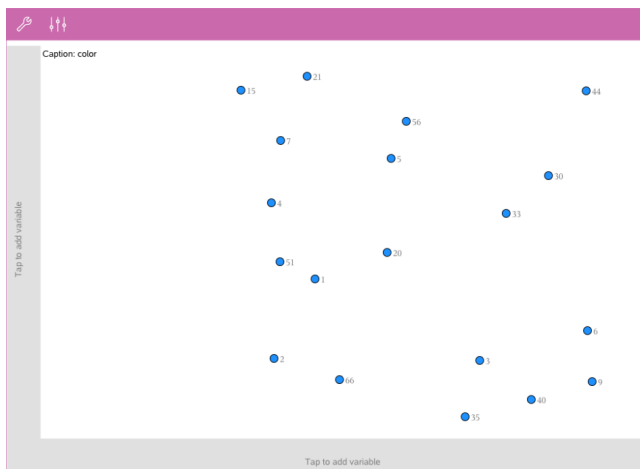

2. Tap the add variable region on each axis to view defined variables.

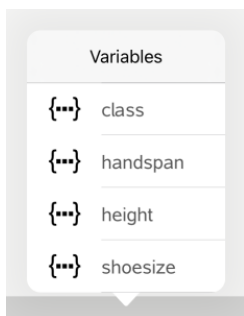

3. Tap the variable name to add it to the selected axis to create a dot plot (frequency plot).

Working with Plots

Dot Plots

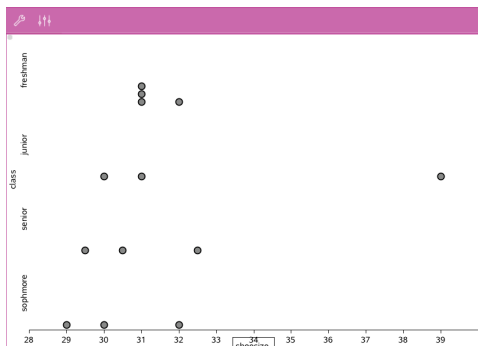

- Dot plots are also known as frequency plots, and represent one-variable numerical data.
- Dot plots are the default plot type for numerical data.
- One dot represents each value in the list.
- Each dot is displayed on the axis at a point that corresponds to the value.

Box Plots

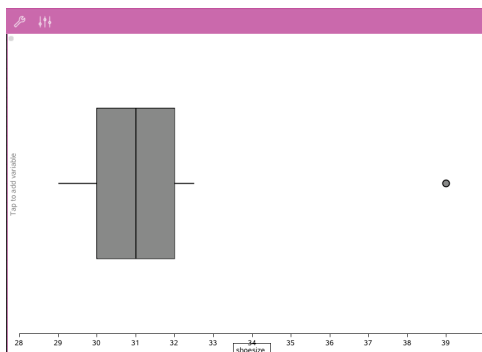

- Box plots are used to plot one-variable numerical data in a modified box.
- "Whiskers" extend from each end of the box.
- Box plots are used to compare two or more sets of data that use the same scale.

Histograms

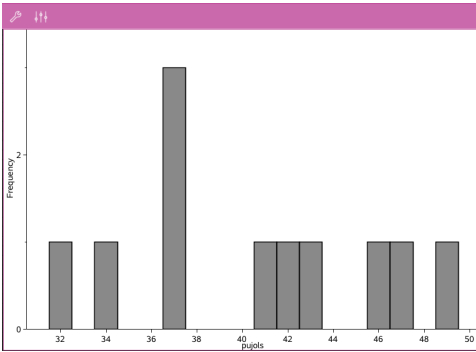

- A histogram plots one-variable numerical data and depicts the distribution of data.
- The number of bins displayed depends on the number of data points and how the points are distributed.
- A value that occurs on the edge of a bin is counted in the bin to its right.

Normal Probability Plots

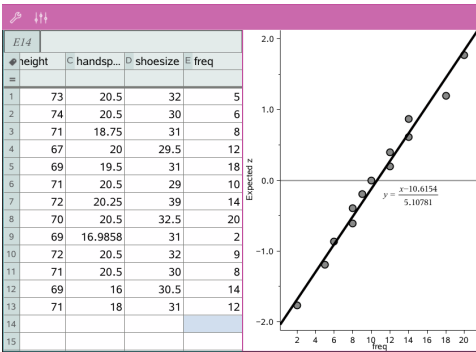

Shows one set of numerical data against the corresponding quartile (z) of the standard normal distribution.

Scatter Plots

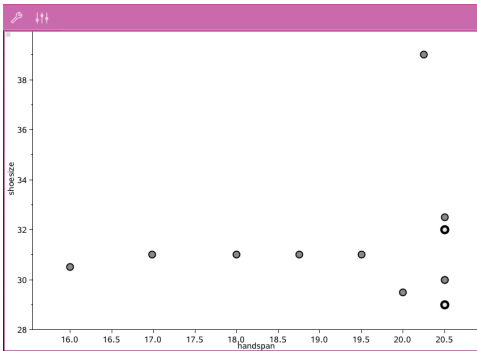

- Shows the relationship between two sets of numerical data.
- You also plot a scatter plot using the Quick Graph tool in the Lists & Spreadsheet application.

X-Y Line Plots

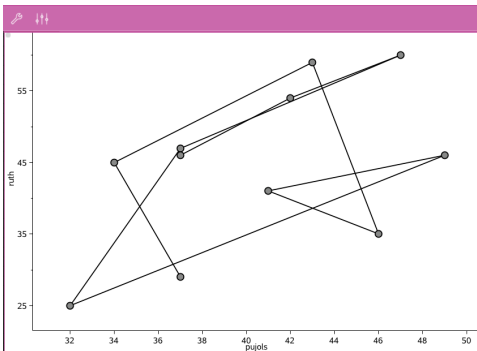

- This plot is a type of scatter plot in which data points are plotted and connected in order of appearance in the two variables.
- An X-Y line plot depicts the relationship between two sets of data.
- The left-most column of data is represented on the horizontal axis.

Exploring and Analyzing Plotted Data

- Drag a point to move it. As you move a point, the values associated with the point change in the work area and in the list of variables.
- To change a variable on an axis, tap the **Add Variable** region, and then tap another variable name.
- From the **Tools**  menu:
 - Tap **Plot Type** to select another supported plot type.
 - Tap **Plot Properties** to clear all variables or to modify properties such as add and remove X and Y variables, add a summary list, or force a categorical X.

- Tap **Actions** to insert text or sliders. You can also select all points in the plot.
- Tap **Analyze** to choose analysis options such as add a moveable line, plot a value or function, or activate the **Graph Trace** tool.

Working with Charts

Dot Charts

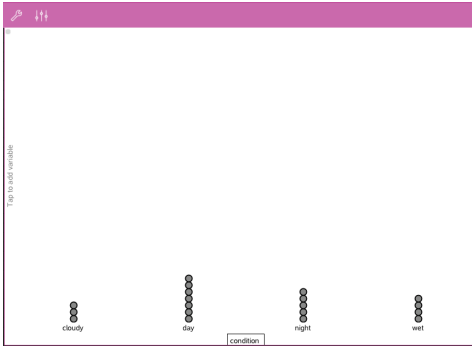

- The default plot type for categorical data is the dot chart.
- When one variable is plotted, the value of each cell is represented as one dot.
- The dots are stacked at the point on the axis that corresponds to the cell value.

Bar Charts

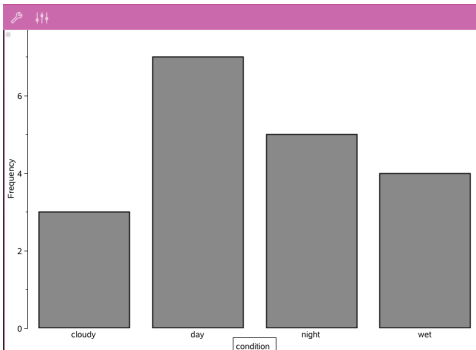

- Bar charts display categorical data.
- The length of the bar represents the number of cases in the category.

Pie Charts

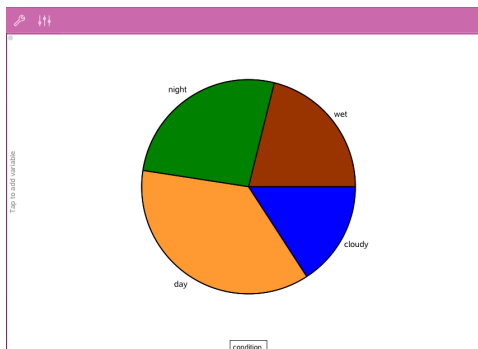

A pie chart represents categorical data in a circular layout and uses a proportioned segment for each category.

Exploring and Analyzing Data Plotted in a Chart

- Drag a point to move it. as you move a point, the values associated with it change in the work area and in the list of variables.
- From the **Tools**  menu:
 - Tap **Plot Type** to choose another supported plot type.
 - Tap **Plot Properties** to clear all variables, or to modify applicable properties such as add and remove X and Y variables, add a summary list, and force a categorical X.
 - Tap **Actions** to insert text and sliders. You can also select all points in the plot.
 - Tap **Analyze** to choose applicable analysis options such as adding a moveable line, plotting a value or function, or activating the **Graph Trace** tool.

Adding Color to Plots and Charts

1. Tap a plot or chart object to select it.

Note: To select all points in a plot, tap **Tools > Actions > Select All Points**.

2. Tap **Inspector** , and then tap **Fill Color**.
3. Tap a color to select it.

Notes Application

The Notes application enables you to create and share documents.

What You Can Do

- Create study notes to reinforce learning and review for exams.
- Share a Notes document with others and use text formatting options so that each person's entries and comments appear in a different color or font.
- Create and evaluate math expressions.
- Create correctly formatted chemical formulas and equations.

Tools Search

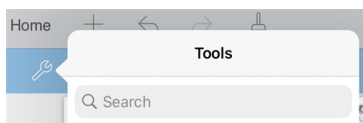

Tools Search allows you to search options and menus. It is available across all applications in the TI-Nspire™ App.

Warning: Tools Search will allow you to search for menu items, but not for command names.

What You Must Know

Deactivating a Selected Expression or Box

Note: You can also activate and deactivate a selected expression or box by selecting **Tools**  > **Actions** > **Activate (Deactivate) All**.

1. Tap the expression or box you want to select, and then tap again.
2. Tap **Select**.



The selected text or item closest to the cursor is highlighted and the handles are active.

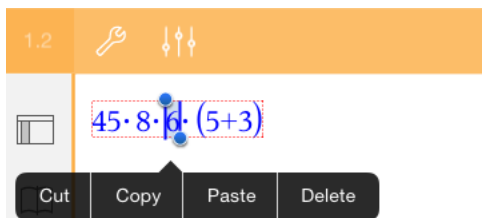

3. Drag the handles to highlight the expression, math box, or chem box you want to select.
4. Tap **Tools**  and go to **Actions**.
5. Tap **Deactivate Selection**.

Activating a Selected Item

1. Tap the expression or box you want to select.
2. Tap **Select**.
3. Drag the handles to select the portion of the expression or text you want to activate.
4. Tap **Tools**  and go to **Actions**.
5. Tap **Activate Selection**.

Formatting Text in Notes

1. Tap the text you want to format, and then tap it again to open the context menu.
2. On the context menu, tap **Select**.
Drag the handles to select additional text, or tap **Select All** to select all of the text.
3. Tap **Inspector** .

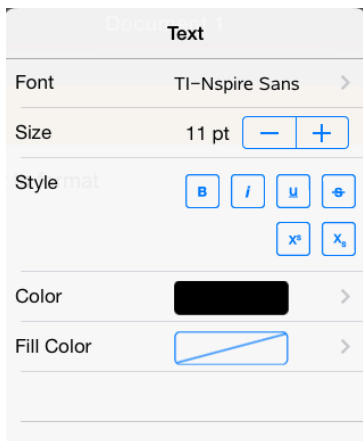

4. Select the formatting you want to apply. Changes are applied as you select them.

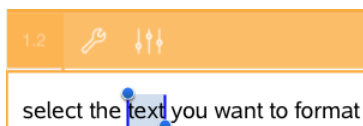

Inserting Comments, Shapes, and Calculations

Inserting Comments

You can insert Teacher or Review comments into a Notes page. Comments are labeled to make them easy to distinguish from the original text.

1. Tap the Notes work area where you want to insert a comment.
2. Tap **Tools**  and go to **Insert**.
3. Tap **Comment**.
4. Tap **Teacher** or **Reviewer** to choose the comment type.



5. Type the comment text inside the comment box.

The comment text appears in **bold** formatting.

- If needed, select the text and tap **Inspector**  to apply formatting to the comment text.

Inserting Geometric Shape Symbols

Use geometric shapes to designate selected text as a geometric object such as an angle, circle, or line segment.

- Tap the work area where you want to insert the shape, or select the text that you want designate as a shape.
- Tap **Tools**  and go to **Insert**.
- Tap **Shape**.

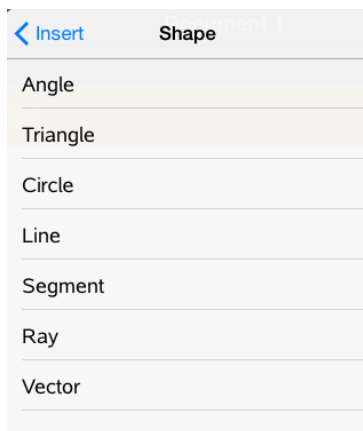

- Tap the shape name (such as segment or ray) to insert it before the selected item.

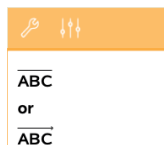

Inserting Calculations

- Tap the Notes work area to place your cursor where you want to insert the math expression.
- Tap **Tools**  and go to **Calculations**.

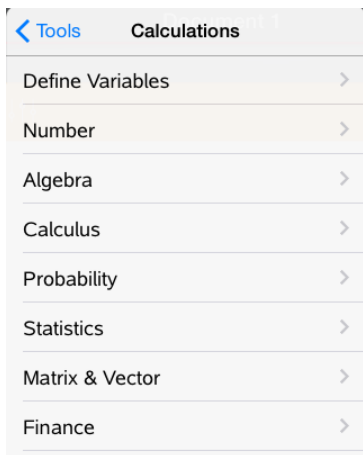

3. Tap the type of calculation you want to insert, and then tap the function name to insert the expression.

Working with Math Boxes

Inserting a Math Box

1. Tap the Notes work area to place your cursor where you want to insert the math box.
2. Tap **Tools**  and go to **Insert**.
3. Tap **Math Box**. If you are using an external keyboard, press $\rightarrow + M$.



4. Type the expression inside the math box. You can also insert a function, command, symbol or expression template by tapping **Utilities**  to access Catalog, Symbols, Math Operators, and Libraries.
5. Tap **enter** to evaluate the expression.

Converting Selected Items to Math Boxes

1. Select the text, or combination of text and existing math boxes, that you want to evaluate.

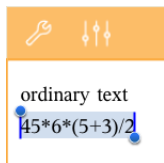

2. Tap **Tools**  and go to **Insert**.

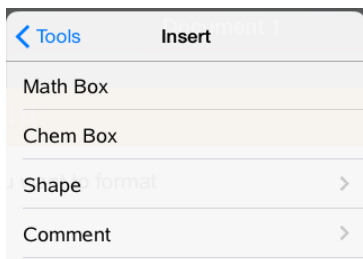

3. Tap **Convert to Math Box**.

Inserting Chemical Equations

Use chemical equation boxes (chem boxes) to type chemical formulas and equations such as:

$\text{CH}_4 + 2\text{O}_2 \rightarrow \text{CO}_2 + 2\text{H}_2\text{O}$. Equations in a chem box cannot be evaluated or balanced.

Entering a Chemical Equation

1. Position the cursor on the page where you want the equation.
2. Tap **Tools**  and go to **Insert**.
3. Tap **Chem Box**.

An empty chemical equation box is added to the page.

4. Type the equation in the box. For example, to represent sulphuric acid, type **h2sO4**, capitalizing the O manually.



5. To exit the chem box, tap outside the box.

Using Math Actions

Math Actions are available on Notes and Calculator pages.

When you display the context menu for a selected expression or equation, the menu may include a **Math Actions** submenu that lists the available actions. Each action might prompt you for any needed parameters.

The specific math actions listed depend on:

- The type of expression or relation.
- The operating system in use (numeric or CAS).

Example of Math Actions in Notes

1. Insert a math box, and type the equation $x^2+3x+1=0$, but don't press **enter** yet.



Numeric OS



CAS OS

2. Tap the equation to display its context menu, and select **Math Actions**.

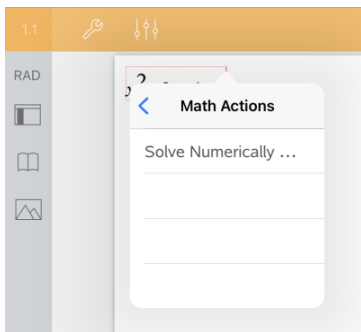

Numeric OS

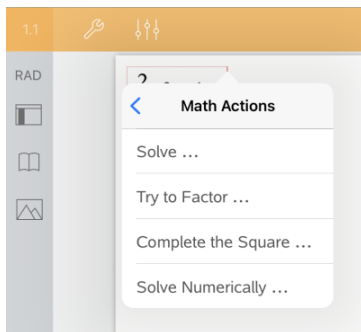

CAS OS

3. Select the action to perform:
 - **Solve Numerically** for numeric OS.
 - **Solve** for CAS OS.

You are prompted to enter parameters. For example, Numeric Solve prompts for the variable of interest, initial guess, lower bound, and upper bound.

4. Type a value for each parameter. When options are available, you can tap an arrow to make a selection.

Cancel	Solve Numerically	OK
Solve for	<input type="text" value="x"/>	>
Guess	<input type="text" value="-2"/>	
Lower	<input type="text" value="-5"/>	
Upper	<input type="text" value="-1"/>	

Numeric OS

Cancel	Solve	OK
Solutions	<input type="text" value="Real"/>	>
Solve for		
x		<input checked="" type="checkbox"/>

CAS OS

5. Tap **OK** to construct the completed expression and place it in the math box.

$$\text{nSolve}(x^2+3x+1=0, x=-2) | -5 \leq x \leq -1$$

Numeric OS

$$\text{solve}(x^2+3x+1=0, x)$$

CAS OS

6. Press **enter** to complete the action.

$$\text{nSolve}(x^2+3 \cdot x+1=0, x=-2) | -5 \leq x \leq -1 \rightarrow -2.61803$$

Numeric OS

$$\text{solve}(x^2+3 \cdot x+1=0, x) \rightarrow x = \frac{-(\sqrt{5}+3)}{2} \text{ or } x = \frac{\sqrt{5}-3}{2}$$

CAS OS

7. As a further exploration, select $x^2+3 \cdot x+1$. Do not include the "=0" portion.

$$\text{nSolve}(x^2+3 \cdot x+1 | 0, x=-2) | -5 \leq x \leq -1 \rightarrow -2.61803$$

Numeric OS

$$\text{solve}(x^2+3 \cdot x+1 | 0, x) \rightarrow x = \frac{-(\sqrt{5}+3)}{2} \text{ or } x = \frac{\sqrt{5}-3}{2}$$

CAS OS

8. Display the context menu for the selected text, select **Math Actions > Find Roots of Polynomial**, and press **enter** to complete the action.

The action and its result are shown in a new math box.

$$\text{polyRoots}(x^2+3 \cdot x+1, x) \rightarrow \{-2.61803, 0.381966\}$$

Numeric OS

$$\text{polyRoots}(x^2+3 \cdot x+1, x) \rightarrow \left\{ \frac{-(\sqrt{5}+3)}{2}, \frac{\sqrt{5}-3}{2} \right\}$$

CAS OS

Tips for Using Math Actions in Notes

- ▶ For a previously evaluated expression, tap the expression to display its context menu.

When you select an action, it replaces the expression.

- ▶ For a displayed result, tap the result to display its context menu.

When you select an action, it appears in a new math box.

- For a portion of an expression or result, select the portion, and then display the context menu.

When you select an action, it appears in a new math box.

Graphing from Notes and Calculator

You can graph a function or relation directly from its context menu. This feature is available for many functions and relations on Notes and Calculator pages.

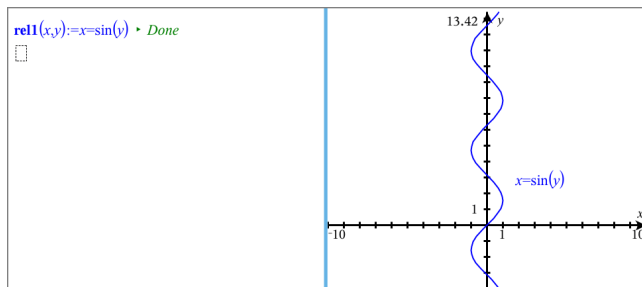
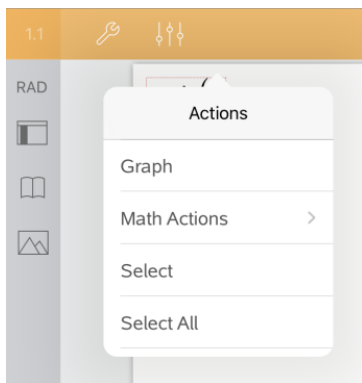

If page layout options allow, the graph appears on the same page as the function or relation. Otherwise, the graph appears on a separate Graphs page.

The type of graph created depends on the type of function or relation.

Example of Graphing from Notes

This example uses a Notes page to explore a quadratic function interactively.

1. Insert a math box on a new Notes page, and enter the following function definition:

$$\text{Define } f1(x) = x^2 - 1 \cdot x - 4$$

define $f1(x)=x^2-1\cdot x-4$

2. Tap the expression to display its context menu.

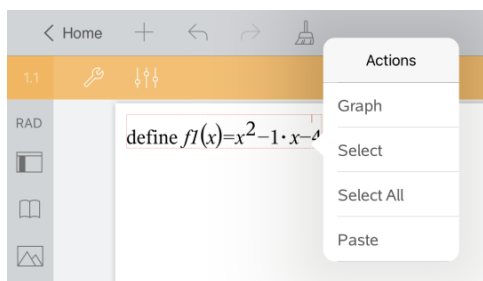

3. Select **Graph**.

The graph appears. The graph and the math box are linked so that any adjustment to one affects the other.

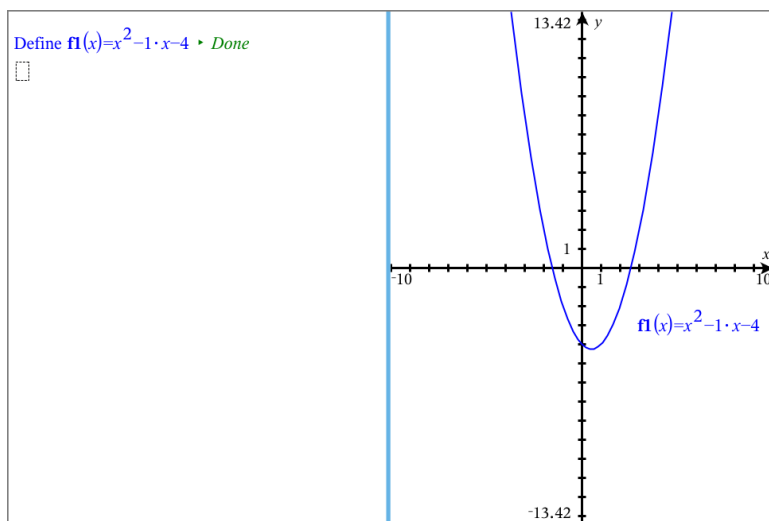

4. Explore the relationship between the defined function and its graph:
- Drag the ends or center of the graph to manipulate it, and observe the changes to the function definition.
 - OR -
 - Edit the defined function in the math box, and observe the changes to the graph.

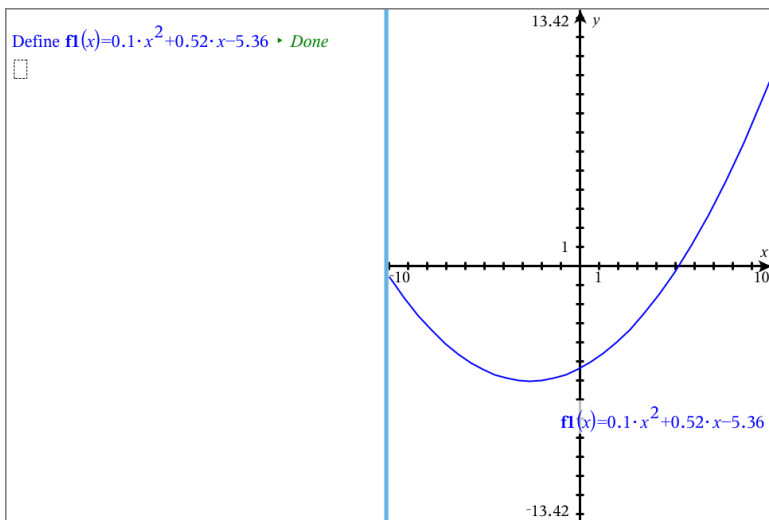

Using a Displayed QR Code®

A QR Code® is an image that stores information, such as the address of a website or TI-Nspire™ document, as a pattern of small squares.



Web address <http://education.ti.com> stored as a QR Code®.

Authors of TI-Nspire™ documents can insert or paste a QR Code® on any Notes page. Users viewing the document with TI-Nspire™ App for iPad® can tell the app to scan the code directly from the page and link to its associated target. Lua scripts can also display a QR Code® that you can scan within the App.

Scanning a QR Code® on a Notes Page or Lua Script

Use this procedure to scan a displayed QR Code® and link to its target:

1. If necessary in Notes, scroll to ensure that only one code image is visible on your screen.

Note: The image must be entirely visible; the software will scan only the displayed region of the page.

2. Tap the Camera  in the toolbar, and select **Scan QR Code® from page**.

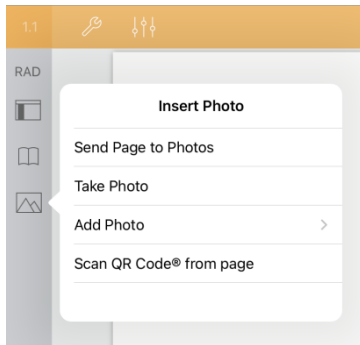

- If the target is a TI-Nspire™ document (.tns file), the App automatically downloads the document, saves and closes your current document, and opens the downloaded document.
- Otherwise, the App opens your web browser to resolve the target.

How to Insert a QR Code® on a Notes Page

You can add QR Code® images to a Notes page. One image per page is best for reliable scanning.

1. Generate the image, using an online code generator or a code-generator app. You will need to supply the target URL.
2. Copy the generated image to the Clipboard, or save it as a photo.
3. Display your Notes page and use the method that applies for adding the image:
 - If you copied the image to the Clipboard, press and hold the location on the page, and select **Paste**.
 - If you saved the image as a photo, position the text cursor on the page, tap the Camera  in the toolbar, and select **Insert Photo**.

The QR Code® appears on the Notes page with resizing handles.



Note: For optimal scanning, you should not resize or reshape the image.

- (Optional) add a tip for users of your document who might not know how to use the code.

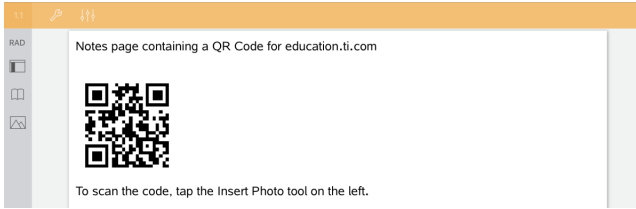

- Make sure the code is valid by testing it with the **Scan QR Code® from page** feature.

Question Documents Overview

The TI-Nspire™ App for iPad® enables you to receive question documents sent by your teacher via email. The question document may contain multiple pages and can contain any TI-Nspire™ application. When you tap question, the icon changes to show you which application is active.

What You Can Do

When you receive a question document from your teacher, you can:

- Open the document and answer the questions.
- Show your work if requested by the teacher.
- Check your answers if the teacher permits.
- Email the document with your responses back to the teacher.

Tools Search

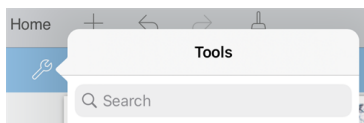

Tools Search allows you to search options and menus. It is available across all applications in the TI-Nspire™ App.

Warning: Tools Search will allow you to search for menu items, but not for command names.

What You Must Know

Inserting Math Boxes and Chem Boxes



You can insert a math expression box or chemical equation box in any area of the response that allows text. Use expression boxes to type properly formatted math expressions. Use chem boxes to type properly formatted chemical formulas or equations.

To insert an expression or chem box:

1. Tap the answer area to place the cursor where you want to place the box.
2. Tap **Tools** , and then tap **Insert**.
3. Tap **Expression Box** to insert a math expression box.

– OR –

Tap **Chem Box** to insert a chemical equation box.

Give the standard deviation of the distribution of cars per household, to the nearest two decimals.



4. Type the expression in the box.
5. Tap **enter** to complete the expression.

Responding to Questions

Teachers may send you any of the following types of questions. Tap a question type name to see how to respond to the question.

Note: You may need to scroll to see the entire question. All parts of the question may not be visible on the page, and parts of a question may be hidden behind a graph or image.

Multiple Choice Questions



 

What is the root of $x^2 = 9$?

- 9
- 3
- 3i
- 9
- 3

- Tap the option or options next to the response you want to select.
- Choices with next to them indicate that there is only one correct answer.
- Choices with next to them indicate that there may be more than one correct answer.

Open Response Questions

One word that describes two lines that never meet but are in the same plane:

Student: Type response here.

Type a response.

Equation Questions

Give a simple example of: parabola

$f(x) = x^2$

Type a response.

If a graph is included in the question, the graph updates as you type the answer. Any functions entered show up on the graph, and the cursor remains in the answer box. You cannot manipulate the graph.

Expression Questions

Write an expression representing the perimeter for the given shape.

Steps:

Enter step

Enter step

Final answer:

Type a response.

- If the teacher wants you to show your work, the response area has sections for you to enter the steps and a final answer.
- If the response type is **Number**, your response must be in the form of a number.
- If the response type is **Expression**, your response must be in the form of an expression, for example: $x + 1$.

Coordinate Points: (x,y) Questions

Write the ordered pair for each given point order: J, N, P

(,)

(,)

(,)

photos.PNG
Type PNG file

Type an answer in the **x-field** box, and then type an answer in the **y-field** box.

As you enter values, the points update on the graph work area.

Coordinate Points: Drop Points Questions

Plot the following points on the coordinate grid.

(6,2)
(0,2)
(0,-4)

- Tap a location on the graph work area to drop a point at that location.
- To move a point, touch and hold the point, and drag it to the new location.

Lists Questions

Enter the data from today's class assignment.

	A list1	B list2
1		
2		
3		
4		
5		
6		

Type an answer in the desired cell. Continue to type answers in different cells until you are finished.

The behavior closely matches the behavior of the Lists & Spreadsheet application, with the following exceptions. In a Lists question, you cannot:

- Add, insert, or delete columns
- Change the header row
- Enter formulas
- Switch to Table
- Create plots

Chemistry Questions

What is the chemical formula for Baking Soda?

Student: Enter chemical notation here.

Type a response.

There is no need to insert a Chem box. Chemistry response areas are automatically formatted to accept properly formatted chemical formulas or equations.

Image: Label Questions

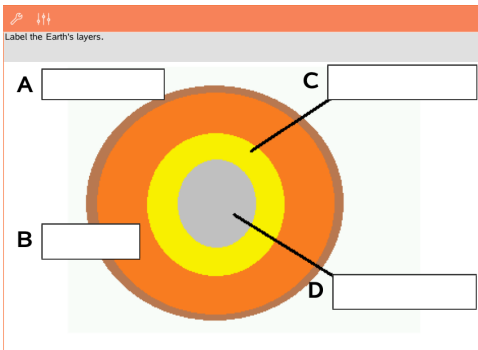

1. Tap a label on the image.
2. Type a response in the label field.

Image: Point on Questions



The picture below shows a plant cell. Identify which organelle is responsible for photosynthesis.

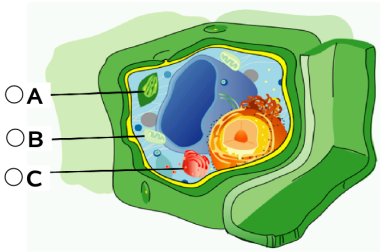

Tap the option or options next to the answer you want to select.

Showing Your Work, Checking Answers, and Clearing Answers

Showing Your Work

The teacher may ask you to show work for your response. If so, the teacher provides the starting equation, and the response area has sections for entering your steps and for the final answer.



Solve for y : $x = 27/y$

Starting equation:

$$x = \frac{27}{y}$$

Steps:

Enter step

Enter step

Final answer:

$y =$ *Enter final answer*

Checking Answers

If the teacher enables self-check on a question, the Check Answer option becomes available after you answer the question. To check your answer:

- ▶ Tap **Tools**  and go to **Check Answer**.

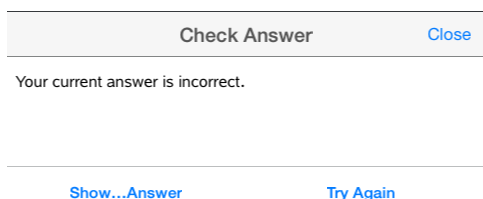

- If your answer is correct, a confirmation message is displayed. When you close the message:
 - A check mark is displayed next to the answer for multiple-choice questions.
 - The correct answer or suggested answer is displayed below the student response for all other question types.
- If your answer is incorrect, tap **Try Again** or **Show Correct Answer**.

Clearing Answers

After you answer a question, you may decide you want to change the answer before you submit it.

1. Tap **Tools** .
2. Tap **Clear Answers**.
 - **Current Question** clears answers for the active question.
 - **Document** clears answers for all questions in the active document.

Submitting Responses

When you finish answering all the questions in the document, save the document and send it back to the teacher.

1. From the open question document, tap **Share** .
2. Tap **Email Document**.

Your default email client opens with the document as an attachment.
3. Type the email address and tap **Send**.

Widgets

All work that you create and save using TI-Nspire™ applications is stored as a document, which you can share with others using TI-Nspire™ software and with those using handhelds. You save these TI-Nspire™ documents as .tns files.

A Widget is a .tns document that is stored in your MyWidgets folder.

You can use Widgets to:

- Easily access text files
- Insert and run scripts (such as Stopwatch)
- Quickly insert a saved problem into a document

When you add a Widget, TI-Inspire™ CX extracts only the first page of the selected .tns file, and inserts it into your open document.

Creating a Widget

A document is regarded as a Widget when it is saved or copied to the designated MyWidgets folder.

If the folder has been inadvertently deleted, you must create it before attempting to use a Widget.

Note: When you add a Widget, TI-Nspire™ App for iPad® extracts only the first page of the selected .tns file, and inserts it into your open document.

Showing the MyWidgets folder

To show the MyWidgets folder on the TI-Nspire™ App for iPad® homepage:

1. Tap Settings Icon.
2. Swipe toggle switch to the right to turn on **Show MyLib & MyWidgets folders**.

Adding a Widget to a Document

1. Open a document.
2. Tap **Add > Widget**.

Note: You will see a submenu showing a list of preloaded layouts and widgets. The Stopwatch Widget and Widget layouts are preloaded. Any .tns file saved to your MyWidgets folder will show up in this list.

3. Tap on the Widget you wish to add to your document.

Saving a Widget

When you save a .tns document, it will appear on the TI-Nspire™ App for iPad® homepage. To add this as a Widget:

- ▶ Tap and drag the document into your MyWidgets folder.

Libraries Overview

A library is a TI-Nspire™ document that contains a collection of variables, functions, and/or programs that have been defined as library objects.

What You Can Do

- Create library documents for storing user-defined variables, functions, or programs.
- Use defined library objects in any TI-Nspire™ document.
- Add library objects to the Catalog.
- Update or refresh libraries so that objects are available to all documents.
- Create shortcuts to library objects.

Tools Search

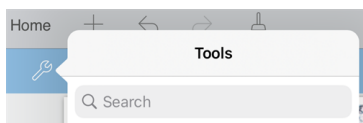

Tools Search allows you to search options and menus. It is available across all applications in the TI-Nspire™ App.

Warning: Tools Search will allow you to search for menu items, but not for command names.

What You Must Know

- Library documents are stored in the **MyLib** folder, which is located on the TI-Nspire™ Home screen.
- By default, the MyLib folder is shown on the TI-Nspire™ Home screen when you install the application. To hide the folder, tap **Settings**  **> Preferences**, and then select **OFF**.
- The TI-Nspire™ App installation includes a library document that contains Linear Algebraic functions. The library is named **linalg** or **linalgcas**.
- If you delete or overwrite an installed library, you can restore it by reinstalling the TI-Nspire™ App.
- Reinstalling the TI-Nspire™ App replaces all libraries in the default **MyLib** folder. If you change an object in an included library or replace an included library document with your own document of the same name, reinstalling overwrites your changes.
- Library objects are global in nature and accessible from any TI-Nspire™ document.
- Library objects can be public or private. If designated as public, the library object is accessible via **Utilities > Libraries**.
- You can use the **libshortcut()** command to define shortcuts to library objects. Defining a shortcut creates a variable group in the current problem that contains references to all the objects in the specified library document. You can choose to include or exclude private library objects.

Creating Library Documents

A document is regarded as a library when it is placed in the MyLib folder on the TI-Nspire™ Home screen.

1. Open a new TI-Nspire™ document and choose the **Calculator**  application.
2. Name the document.
 - Library document names must be a valid variable name, and they must not contain a period or begin with an underscore.
 - A library document name must be between 1 and 16 characters long.
3. Drag the document to the **MyLib** folder.
4. Add library functions or programs to the document as needed.

Adding Objects to a Library Document

You can define functions or programs in the Program Editor, or by using the **Define** command in Calculator to define variables, functions, or programs. Library objects must reside in the first problem of a library document.

Defining a Function or Program Using Program Editor

1. Tap **Tools**  and go to **Functions & Programs**.
2. Tap **Program Editor > New**.
3. Type the name of the library object.
 - Library object names must be a valid variable name, and they must not contain a period or begin with an underscore.
 - A library object name must be between 1 and 15 characters long.
4. Select the type: function or program.
5. Set the library access.
 - Tap **> LibPriv** to make the function or program accessible from any document but not visible in the Catalog.
 - Tap **> LibPub** (Show in Catalog) to make the function or program accessible from any document and visible in the Catalog.
6. Tap **OK**.
7. Type the information needed to complete the function or program in the template.
8. Store the library object.
 - a) In Program Editor, tap **Tools > Check Syntax & Store**.
 - b) Tap **Check Syntax & Store**.

If no errors are present, the new library object is successfully stored.

```
"xsquare" stored successfully
Define LibPub xsquare()=
Func
f(x)=x^2+3
EndFunc
```

9. Refresh the libraries to include the new library object in the Libraries menu.

Defining a Library Object in the Calculator Application

1. From an open Calculator document, tap **Tools**  and go to **Actions**.
2. Tap **Library**.
3. Select **Define LibPriv** or **Define LibPub**.
4. Type the information needed to complete the function or program in the template.
5. Refresh the libraries to include the new library object in the Libraries menu.

Private and Public Library Objects

When defining a new library object, you choose whether it is private (LibPriv) or public (LibPub). Anytime you are in the same problem where an object is defined, you can access it by entering its short name (the name given when using the **Define** command to create an object). This is true for all defined objects, including private, public, and non-library objects. For example:

Define Command	Object Type	Short Name
Define a=5	Non-library	<i>a</i>
Define LibPriv b=(1,2,3)	Private Library	<i>b</i>
Define LibPub func1 (x)=x^2 + 1	Public Library	<i>func1</i>

Private Library Objects

A Private library object does not appear in the Utilities, but you can access it by typing its name. Typically, private library objects are used as building blocks that perform basic, low-level tasks and are called upon by public programs or functions.

Public Library Objects

A Public library object appears in **Utilities > Libraries** after you refresh the libraries. You can access a public library object through the Utilities menu or by typing its name.

In library programs and functions defined as public, a comment line (©) immediately following the **Prgm** or **Func** line is automatically displayed as help in the Catalog. You could, for example, show a syntax reminder there.

- To enter a comment line, tap **Tools**  and go to **Actions > Insert Comment**.

Accessing Library Objects

To use a library object in any TI-Nspire™ document, type the object's long name. The long name consists of the name of the object library document followed by a backslash "\" followed by the name of the object. For example, if the library document name is "lib1" and the object name is "func1," type **lib1\func1**.

Using a Public Library Object

1. Open the TI-Nspire™ application where you want to use the variable, function, or program.

Note: All applications can evaluate functions, but only the Calculator and Notes applications can run programs.

2. Tap **Utilities**  and go to **Libraries**.
3. Tap the name of the object you want to use.

Note: If you do not see the object, refresh the libraries.

4. If arguments are required, type them inside the parentheses.
5. Tap **return** to insert the object into the document.

Using a Private Library Object

1. Open the TI-Nspire™ application where you want to use the variable, function, or program.

Note: All applications can evaluate functions, but only the Calculator and Notes applications can run programs.

2. Type the name of the object, such as **lib1\func1 ()**.

In the case of a function or program, always follow the name with parentheses.

3. If arguments are required, type them inside the parentheses.
4. Tap **return** to insert the object into the document.

Viewing Arguments

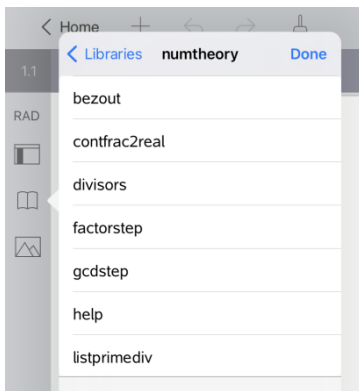

If you cannot remember the exact name or the order of arguments required for a private library object, you can:

- ▶ Open the library document that contains the object to view the arguments and other information.
- OR –
- ▶ Type `getVarInfo [library name string]` in any open document to view a list defined variables in an object.
- OR –
- ▶ Access the arguments and help through the Utilities menu.
 - a) Tap **Utilities > Libraries**.
 - b) Tap the name of the library you want to open.
 - c) Tap the name of the function you want to view.



Refreshing Libraries

When you create new library objects, you must refresh the libraries so that the objects are available to all documents.

1. Tap **Utilities** .
2. Tap Libraries.
3. Tap Refresh .

The Libraries are updated to include all new and edited library objects.

Program Editor Overview

The Program Editor enables you to define, edit, and manage user-defined functions and programs.

What You Can Do

- Use programming templates and dialog boxes to define function and programs with the correct syntax.
- Enter multiple-line programming statements without using a special key sequence to add each line.
- Create private and public library objects such as variables, functions, and programs.

Tools Search

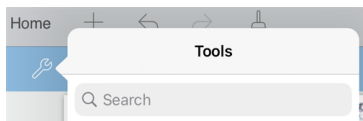

Tools Search allows you to search options and menus. It is available across all applications in the TI-Nspire™ App.

Warning: Tools Search will allow you to search for menu items, but not for command names.

What You Must Know

A program defined in the Program Editor is similar to functions built into the TI-Nspire™ software, but there are some differences:



- Functions must return a result, which can be graphed or entered in a table. Programs do not return a result.
- You can use a function, but not a program, within an expression. For example, $3 \times \text{func1}(3)$ is valid, but not $3 \times \text{prog1}(3)$.
- You can only run programs from the Calculator and Notes applications. You can evaluate functions in Calculator, Notes, Lists & Spreadsheet, Graphs, Geometry, and Data & Statistics.
- A function can refer to any variable; however, it can store a value to a local variable only. Programs can store to local and global variables.

Note: Arguments used to pass values to a function are automatically treated as local variables. If you want to store to any other variables, you must define them as **Local** from within the function.

- A function cannot call a program as a subroutine, but it can call another user-defined function.
- You cannot define a program within a function.
- A function cannot define a global function, but it can define a local function.

Accessing the Program Editor

Program Editor is accessible from the Calculator application.

1. Open a document with the Calculator  application active.
2. Tap **Tools**  and go to **Functions and Programs**.
3. Tap **Program Editor**.

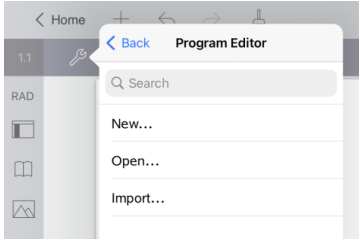

Options enable you to define a new program, open an existing program, or import a program from the Library.

4. Tap an option, complete the required information, and then tap **OK**.

The Program Editor opens with the selected template active on the right side of the screen.

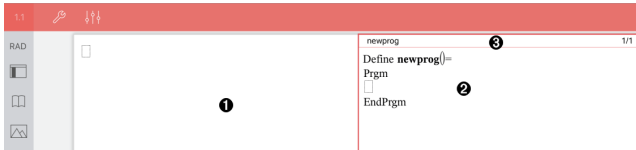

- ❶ **Calculator work area.** Tap the left side of the screen to return to and work in the Calculator application.
- ❷ **Program Editor work area.** This is the default work area when Program Editor opens. If the Program Editor is not active, tap the right side of the screen.
- ❸ **Status line.** Shows the line number information and the name of the function or program being defined or edited. An asterisk (*) indicates that this function has been changed since the last time syntax was checked and the function was stored.

Defining a New Program or Function

From the Calculator application:

1. Tap **Tools**  and go to **Functions & Programs**.
2. Tap **Program Editor**, and then tap **New**.

New	
Name:	<input type="text" value="Input your value"/>
Type:	<input type="text" value="Program"/> >
Library Access:	<input type="text" value="None"/> >

3. Type a name for the new function or program.

Note: Program and function names cannot contain spaces.

4. Select the **Type** (Program or Function).

5. Set the **Library Access**:

- Choose the default **None** to use the function or program only in the current document or problem.
- Tap > **LibPriv** to make the function or program accessible from any document but not visible in the Catalog.
- Tap > **LibPub** (Show in Catalog) to make the function or program accessible from any document and visible in the Catalog.

6. Tap **OK**.

The Program Editor opens with a template matching the selections you made.

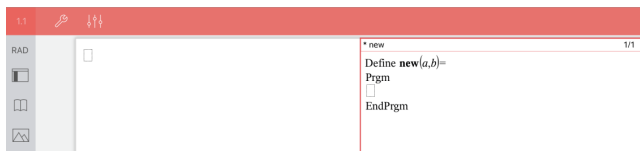

Entering Lines into a Function or Program

The Program Editor does not execute the commands or evaluate expressions as you type them. They are executed only when you evaluate the function or run the program.

- When arguments are required, type parameters in the parentheses that follow the program name. Separate parameters with a comma.

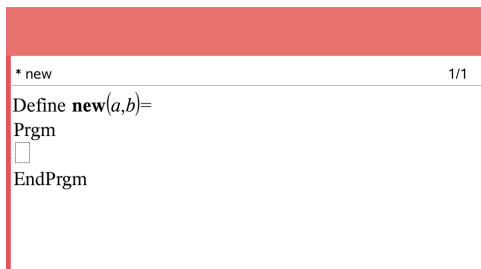

- Type the lines of statements that make up your function or program between the Func and EndFunc (or Prgm or EndPrgm) lines.

```
* new 3/3
Define new(a,b)=
Prgm
Disp "a=",a
Disp "=",b
Disp "a^b=",a^b
EndPrgm
```

- You can either type the names of the function and commands, or insert them from the Catalog.
- If a line is longer than the width of the screen, scroll to view the entire statement.
- After typing each line, tap return to insert a new blank line.
- Tap the right, left, up, and down arrows to scroll through the function or program.

Checking Syntax

To check the function or program for correct syntax:

1. Make sure the Program Editor is active.
2. Tap **Tools**  and go to **Check Syntax and Store**.
3. Tap **Check Syntax**.

If the syntax checker finds any errors, it displays an error message and positions the cursor near the first error.

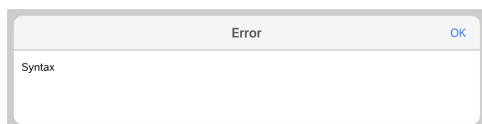

```
Syntax
Define syntax(a,b)=
Prgm
Disp "a="";a
EndPrgm
```

Storing a Function or Program

You must store a function or program to make it accessible. The Program Editor automatically checks the syntax before storing. An asterisk (*) before the program or function name indicates that it has not been stored. To store a function or program:

1. From the Program Editor, tap **Tools**  and go to **Check Syntax and Store**.

2. Tap **Check Syntax & Store**.

Program Editor checks for syntax errors and stores the program.

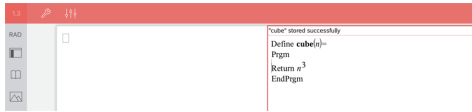

- If no syntax errors are found, the message "stored successfully" is displayed in the status line after the program or function name.
- If syntax errors are found, an error message is displayed and the cursor is positioned near the first error.
- If the function or program is defined as a library object, you must also save the document in the designated library folder and refresh libraries to make the function or program accessible to other documents.

Running Programs and Evaluating Functions

After defining and storing a program or function, you can use it from an application. All the applications can evaluate functions, but only the Calculator and Notes applications can run programs.

The program statements are executed in sequential order (although some commands alter the program flow). The output, if any, is displayed in the application's work area.

- Program execution continues until it reaches the last statement or a **Stop** command.
- Function execution continues until it reaches a **Return** command.

Running a Program or Function from the Program Editor

1. Make sure you have defined a program or function and the Program Editor is the active work area.
2. Tap **Tools**  and select **Check Syntax & Store > Run**.

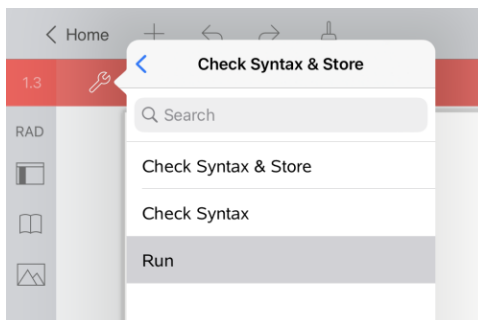

This will automatically:

- check the syntax and store the program or function,

- paste the program or function name on the first available line of the Calculator page.

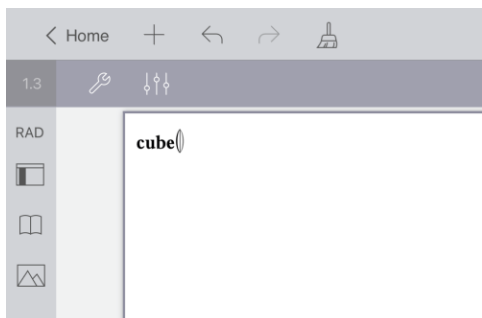

3. If the program or function requires you to supply one or more arguments, type the values or variable names inside the parentheses.
4. Tap **enter**.

Note: You can also run a program or function in Calculator or Notes applications by typing the name of the program with parentheses and any required arguments and tapping **enter**.

Opening Functions or Programs for Editing

Note: You cannot modify a locked program or function. To unlock the object, go to a Calculator page and use the **Unlock** command.

Opening a Function or Program in Calculator

1. Tap Tools  and go to **Functions & Programs**.
2. Tap **Program Editor**, and then tap **Open**.

The list of defined functions and programs available to the current problem opens.

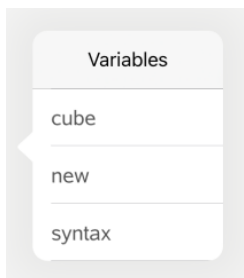

3. Tap the function or program name to open it in Program Editor.

Opening a Function or Program in Program Editor

1. Tap **Tools**  and go to **Actions**.
2. Tap **Open**.
3. Tap the function or program name to open it in Program Editor.

Note: To close the function or program, tap **Tools > Actions > Close**. The program or function closes and the Calculator page becomes active.

Importing Programs

You can import a function or program defined as a library object into a Program Editor within the current problem. The imported copy is not locked, even if the original is locked.

Importing a Program from a Library

1. From the Program Editor, tap **Tools**  and go to **Actions**.
2. Tap **Import**.

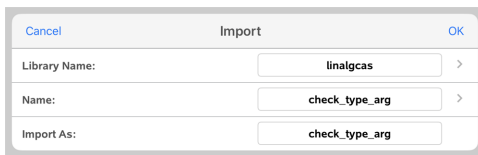

	Import	
Library Name:	<input type="text" value="linalgcas"/>	>
Name:	<input type="text" value="check_type_arg"/>	>
Import As:	<input type="text" value="check_type_arg"/>	

3. In the **Library** field, tap **>**, and then tap the library name you want to import.
4. In the **Name** field, tap **>**, and then select the name of the object.
5. If you want the imported object to have a different name, type the name in the **Import As** field.
6. Tap **OK**.

Importing a Program from Calculator

1. Tap **Tools**  and go to **Functions & Programs**.
2. Tap **Program Editor**, and then tap **Import**.
3. In the **Library** field, tap **>**, and then tap the library name you want to import.
4. In the **Name** field, tap **>**, and then select the name of the object.
5. If you want the imported object to have a different name, type the name in the **Import As** field.

6. Tap **OK**.

The program opens in Program Editor.

Using Test Mode

The guidelines for many international, national, and state assessments allow or require students to use TI-Nspire™ App for iPad® when taking an exam. Test Mode enables you to quickly prepare the software for exams where use of applications, programs, and other files is restricted.

Test Mode can be configured by tapping the Lock  icon and using either the **Choose Test Mode Restrictions** or **Enter Test Code** option. When the software is in Test Mode, students cannot access pre-existing folders or documents. After the exam, these documents and features can be easily restored for classroom use.

Note: To find out if your state allows TI-Nspire™ technology, see the State/Province Information website at education.ti.com/go/testprep.

Preparing the iPad® for Test Mode

Before entering Test Mode, make sure that TI-Nspire™ has access to Photos.

- Photos = All Photos or Selected Photos

To validate or change the access to your photos:

1. On the iPad® Home screen, tap **Settings** .
2. Go to **TI-Nspire > Photos** or **TI-Nspire CAS > Photos**.
3. Tap **All Photos** or **Selected Photos** if it is not already selected.

More Information

TI-Nspire™ Test Mode uses Apple Automatic Assessment Configuration (AAC) with default restrictions.

Entering Test Mode by Choosing Restrictions

Note: This applies to the TI-Nspire™ App for iPad® and the TI-Nspire™ CAS App for iPad® except where noted. If you already have a test code, you can use the [Enter Test Code method](#).

1. Tap **Test Mode**  and then **Choose Test Mode Restrictions**.

This will open the **Test Mode Restrictions** dialog box.

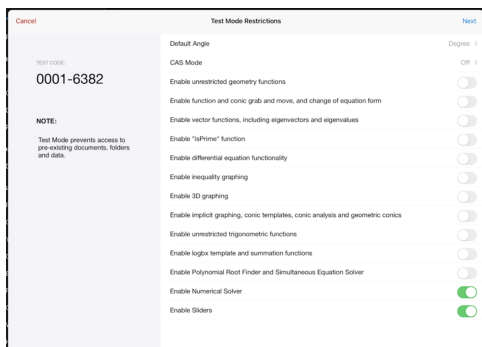

2. Select the **Default Angle** you wish to use. Available units are Degree and Radian.
3. Select the **CAS Mode** you wish to use. (TI-Nspire™ CAS App for iPad® only)
 - **On** enables CAS functions and symbol manipulation.
 - **Exact Arithmetic** enables exact results in terms of stacked fractions, π , and radicals $\sqrt{}$.
 - **Off** disables CAS and exact results.
4. Tap the toggle switch to enable or disable each restriction as needed.

The Test Code will automatically update based on your selections.

Note: For a detailed list of restrictions, refer to [Understanding Test Mode Restrictions](#).

5. Tap **Next**.
6. On the **Confirm App Self-Lock** prompt, tap **Yes**.

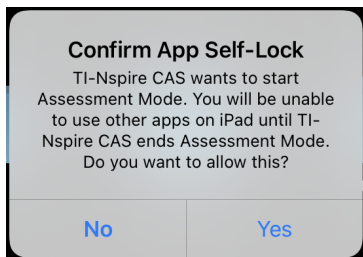

- Pre-existing clipboard data is deleted.
- A green title bar indicates that the software is in Test Mode. It displays the Exit icon, Undo/Redo icons, Clear Document icon, the CAS or Exact Arithmetic mode status (when appropriate), Test Code, time elapsed while in the test session, the Test Mode Information icon, and the Settings icon.

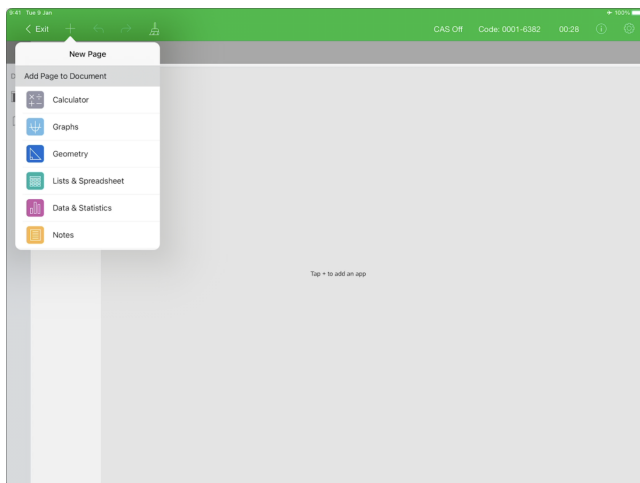

Entering Test Mode with a Test Code

Note: This applies to the TI-Nspire™ App for iPad® and the TI-Nspire™ CAS App for iPad® except where noted. If you do not know the test code, you can obtain it by using the [Choose Restrictions method](#).

1. Tap **Test Mode**  and then **Enter Test Code**.

This will open the Test Mode dialog box with the TI Factory Default Code 0001-6382 entered by default.

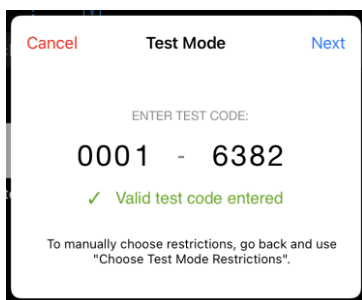

2. Enter your eight-digit test code.

If the code is valid, a green checkmark will display.

When the code is validated, it is stored and will be displayed when the **Enter Test code** dialog is invoked again.

The same test codes are used for both the TI-Nspire™ App for iPad® and the TI-Nspire™ CAS App for iPad®, as well as TI-Nspire™ CX II handhelds and desktop software. The CAS and Exact Arithmetic Mode settings are ignored when appropriate.

3. Tap **Next**.

The Summary screen displays so you can review the restrictions. Tap **Back** if you need to enter a different code.

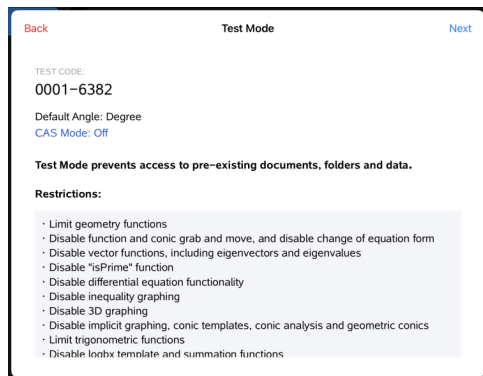

4. Tap **Next**.

5. On the **Confirm App Self-Lock** prompt, tap **Yes**.

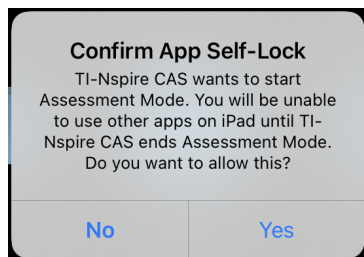

- Pre-existing clipboard data is deleted.
- A green title bar indicates that the software is in Test Mode. It displays the Exit icon, Undo/Redo icons, Clear Document icon, the CAS or Exact Arithmetic mode status (when appropriate), Test Code, time elapsed while in the test session, the Test Mode Information icon, and the Settings icon.

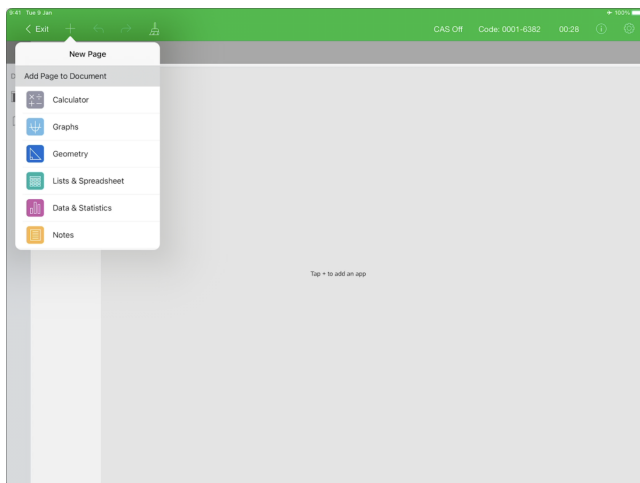

Test Code Examples

TI Factory Default Restrictions

- Default Angle = Degree
- CAS Mode = Off
- Numerical Solver and Sliders are enabled

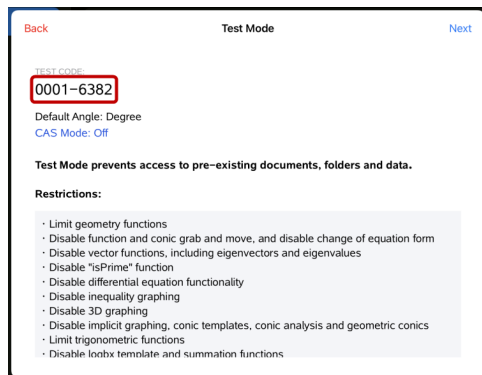

Minimum Restrictions

- Default Angle = Degree
- CAS Mode = On
- All restrictions off

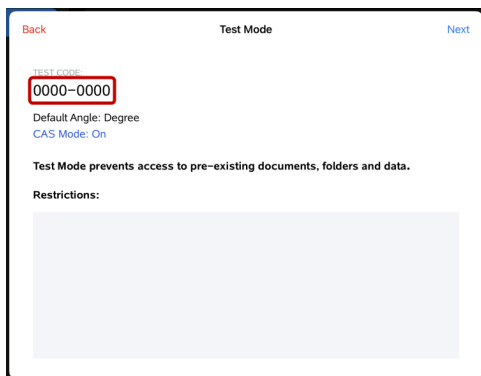

Maximum Restrictions

- Default Angle = Degree
- CAS Mode = Off
- All restrictions on

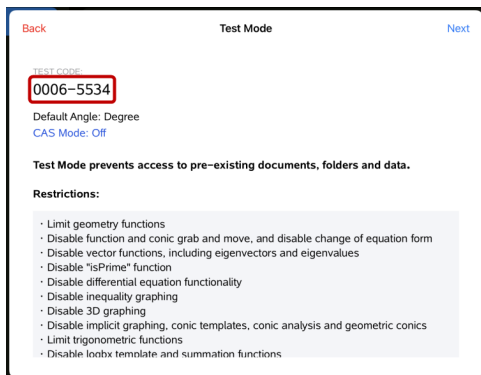

Note: Maximum restrictions Test Code will change if additional restrictions are added in the future.

Reviewing Test Mode Restrictions

You can review the restrictions in effect when the app is in Test Mode. You cannot change the restrictions while in the testing session. You must exit Test Mode and re-enter it with new restrictions.

To review the current restrictions:

1. Tap the information icon  in the Test Mode bar.

The Test Mode Information dialog opens which displays the following:

- Test Code

- Session ID
- Time in Test Mode
- Default Angle
- CAS Mode
- TI-Nspire™ App for iPad® version
- Restrictions

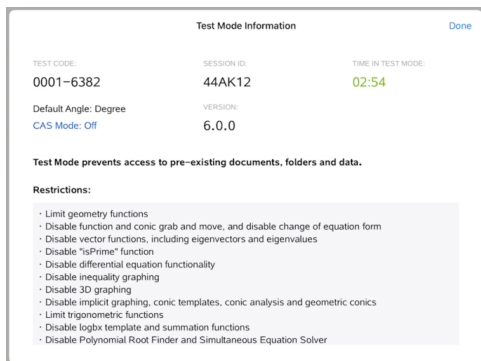

2. Tap **Done** to return to the current test session.

Working with a Document in Test Mode

While in Test Mode, you will only see a default document created during the test session. You cannot open documents that were created before entering Test Mode.

Creating a New Document

1. Tap **New** + in the toolbar.
2. Select an application to add to the document.

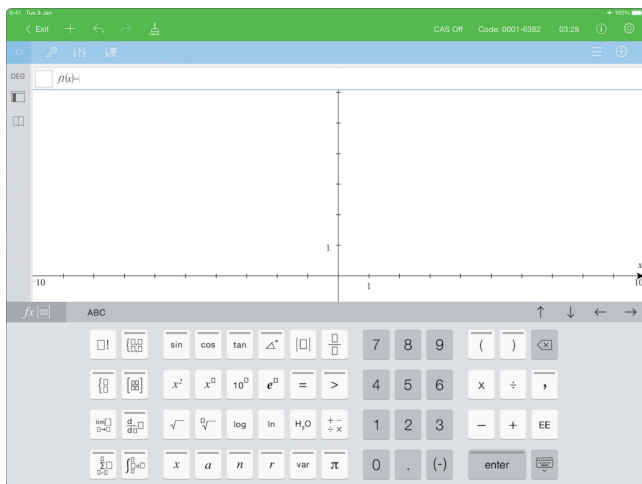

Based on the restrictions that were enabled manually, or set by a test code:

- the restricted functionality is disabled,
- the appropriate menu items are removed,
- an error message is displayed when you try to execute restricted functions by typing them or pasting from the Catalog.

Exiting Test Mode

When you exit Test Mode, the temporary document created during the session is deleted and TI-Nspire™ document settings are restored to their state before you entered Test Mode.

To exit Test Mode:

1. Tap the **< Exit** button on the Test Mode title bar.
2. On the **Exit Test Mode** prompt, tap **Yes**.

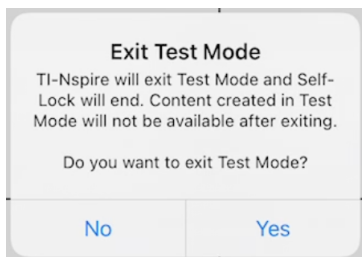

The Test Mode Summary dialog opens which displays the following:

- Test Code

- Date
- Time in Test Mode
- Start Time and End Time
- Session ID
- App Version

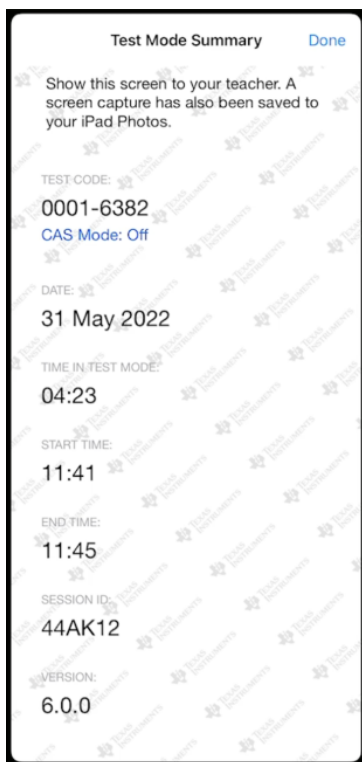

3. Tap **Done**.

The Test Mode Summary dialog will be saved to your iPad® Photos album.

Understanding Test Mode Restrictions

By default, all restrictions are disabled when you enter a Test Mode session with the exception of Numerical Solver and Sliders.

- Enabling a restriction allows its associated features to be used during the session.
- Disabling a restriction disables or limits its associated features during the session.

Restricting Geometry Functions

When you choose to limit geometry functions, all items on the **Measurement**, **Construction**, and **Transformation** menus are disabled.

Disabling Function and Conic Grab and Move, and Change of Equation Form

- You cannot move any function or conic in Graphs or Geometry. For example, if you have graphed $y=x^3$, you can select the function but you cannot move or manipulate it by dragging.
- You cannot access the attribute that toggles the displayed form of a second degree polynomial relation between Standard and Expanded.
- Disabling function and conic grab and move does not apply to lines and functions in Data & Statistics.
- Disabling function grab and move does not restrict sliders in the Graphs and Geometry applications.
- You can still grab the coordinate plane and move it around.

Disabling Vector Functions

When vector functions are disabled, students cannot calculate the following functions:

- Unit vector [unitV()]
- Cross product [crossP()]
- Dot product [dotP()]
- Eigenvector [eigVc()]
- Eigenvalue [eigVI()]

Disabling the “isPrime” Function

The **isPrime()** function determines if a number is a prime number (a whole number greater than two that is evenly divisible only by itself and one). Disabling this function prevents students from selecting the **isPrime()** command in the Catalog and from selecting **Test > IsPrime** in Math Operators. If a student manually enters the **isPrime()** function, submitting the expression results in an error message.

Disabling Differential Equation Functionality

The Differential Equation graph type is disabled in the Graphs and Geometry applications. Users cannot manually type and graph a differential equation.

Related math functions **rk23()**, **euler()**, and **deSolve()** are also disabled.

Disabling Inequality Graphing

When inequality graphing is disabled, students cannot graph inequalities with $<$, $>$, \leq , and \geq or grab and drag inequalities to a graph in the Graphs and Geometry applications.

Disabling 3D Graphing

When this feature is disabled, students cannot use the 3D Graphing view.

Disabling Implicit Graphing, Conic Templates, Conic Analysis, and Geometric Conics

When these features are disabled, students cannot graph equations in terms of $x = ay + c$ or $ax + by = c$. Conic templates are not available, and students cannot analyze conics or graph the geometric conic of an ellipse, parabola, hyperbola, or conic by five points.

Disabling Trigonometric Functions

Disabling trigonometric functions prevents students from using the following functions in calculations and graphing.

csc	sec	cot
csc^{-1} , arccsc	sec^{-1} , arcsec	cot^{-1} , arccot
csch	sech	coth
csch^{-1} , arccsch	sech^{-1} , arcsech	coth^{-1} , arccoth

- Attempting to evaluate any of these functions results in an error message.
- Students cannot select the disabled functions from the Catalog.

Disabling the $\log_b x$ Template and Summation Functions

Students cannot use the $\log_b x$ (convert to logbase) and $\log(a, b)$ commands and templates, including $\log_b x$ templates.

- Only calculations in \log_{10} format are accepted.
- If a student manually enters **log(a,b)** or **>logbase(** into an expression, attempting to evaluate the expression results in an error message.
- Students are allowed to enter **log(a)**, **log(a,10)**, and **log(a,10.)**.

Students are also prevented from using summation functions and templates. The Σ (and **sumSeq**(functions are disabled.

Disabling Polynomial Root Finder and Simultaneous Equation Solver

The **polyRoots**(, **cPolyRoots**(, **solve**(, **simult**(, **zeros**(, and **cZeros**(functions are disabled. Attempting to evaluate any of these functions results in an error message.

Note: When the polynomial tools are disabled, students cannot use Find Roots of Polynomial, Real Roots of Polynomial, or Complex Roots of Polynomial.

The **linSolve**(and **simult**(functions are disabled in menus and in the Catalog. Attempting to evaluate either of these functions results in an error message.

Disabling Numerical Solver

The **nSolve**(is disabled in menus and in the Catalog. Attempting to evaluate either of these functions results in an error message.

Disabling Sliders

When this feature is disabled, students cannot insert or create sliders in the Graphs, Geometry, Data & Statistics, and Notes applications.

General Information

Online Help

education.ti.com/eguide

Select your country for more product information.

Contact TI Support

education.ti.com/ti-cares

Select your country for technical and other support resources.

Service and Warranty Information

education.ti.com/warranty

Select your country for information about the length and terms of the warranty or about product service.

Limited Warranty. This warranty does not affect your statutory rights.

Texas Instruments Incorporated

12500 TI Blvd.

Dallas, TX 75243

Index

#

3D aspect ratio, changing	81
3D functions	
graphing	76
3D graph	
changing appearance	79
3D graphing	163
3D Graphing view	75, 78
3D graphs	
editing expressions	78
range settings	81
rotating	78
setting background colors	80
showing/hiding	79
shrinking/magnifying	80
3D parametric equations	
graphing	77

A

angle bisector construction	66, 90
animating	
points	42, 83
appearance	
of 3D graph	79
applications	
Geometry	82
Graphs & Geometry	41
arithmetic calculations	70, 91
aspect ratio, changing in 3D	
graphing	81
attributes	
changing for objects	41, 82
automatic	
sliders in Graphs application ...	35
axes	
changing attributes in Graphing	
view	58

B

bisect a segment	66, 90
bisecting an angle	66, 90

C

calculating distributions (Lists &	101
------------------------------------	-----

Spreadsheet)	
calculations	
arithmetic	70, 91
capturing	
data (Lists & Spreadsheet)	108
colors	
3D graph background	80
commands	
cSimult(.....	164
inSolve(.....	164
sumult(.....	164
compass construction	66, 90
conic analysis	163
conic templates	163
constructions	
angle bisector	66, 90
compass	66, 90
locus	66, 90
midpoint	66, 90
parallel line	66, 90
perpendicular bisector	66, 90
perpendicular line	66, 90
context menu	
graphing from	127
creating	
new documents	159
shapes with MathDraw	71, 91

D

data	
capturing (Lists & Spreadsheet)	108
delete	
all TI-Nspire™ content	5
differential equation graphing	162
disabling functions	
"isPrime"	162
3D graphing	163
conic analysis	163
conic templates	163
differential equation graphing .	162
function and conic grab and	
move	162
geometry functions	162
implicit graphing	163
inequality graphing	163
logbx template	163
numeric solver	164
polynomial root finder	164

sliders	164	relations	47
trigonometric functions	163	scatter plots	52
vector functions	162	sequences	52
distribution, calculating	101	time plots	52
documents	159	web plots	52
Reset Content	5	Graphing view	
		changing axes attributes	58
		Graphs & Geometry application	41
E		H	
enabling		hiding	
Test Mode	153, 155	3D graphs	79
equations			
differential	55	I	
graphing	46	images	
graphing parametric	49	inserting background	41, 82
graphing polar	50	implicit graphing	163
Lotka-Volterra	54	inequality graphing	163
exiting		inserting	
Test Mode	160	background images	41, 82
expressions		isPrime function	162
editing	78		
		L	
F		lines	
function and conic grab and move ..	162	creating	62, 86
functions		Lock Geometry Tools (points, triangles, segments, etc.)	
rotating	45	for repetitive use	73, 94
stretching	45	locus construction	66, 90
supported distributions	103	logbx (convert to logbase)	163
translating	45	logbx template	163
		Lotka-Volterra equations	54
G			
geometric objects		M	
introduction	62, 86	math actions	124
Geometry application	82	MathDraw, creating shapes with	
geometry functions	162	gestures	71, 91
gestures, to create shapes		midpoint construction	66, 90
(MathDraw)	71, 91	models, PDF distribution	101
graph			
changing appearance	79	N	
graphing		new documents	159
3D functions	76	Notes	
3D parametric equations	77	using a QR Code®	129
3D view	75	numeric solver	164
equations	46		
from context menu	127		
parametric equations	49		
path plot	45		
polar equations	50		

O	
objects	
changing appearance	41, 82
objects (geometric), introduction ...	62, 86

P	
parallel line construction	66, 90
parametric equations	
graphing	49
perpendicular bisector construction	66, 90
perpendicular line construction	66, 90
plots	
customizing	53
graphing	52
path plot	45
plotting	
path plot	45
points	
animating	42, 83
creating	62, 86
of interest	45
polar equations	
graphing	50
polynomial root finder	164
preparing	
Test Mode	153

Q

QR Code®	
scan from a Notes page	129

R

relations	
graphing	47
reset TI-Nspire™ content	5
reviewing	
restrictions	158

S

scan	
QR Code® on a notes page	129
segment	
bisector	66, 90
shapes	
creating	62, 86
creating with MathDraw	71, 91

showing	
3D graphs	79
sliders	164
sliders, adjusting variable values	35
sticky tool in geometry and graphing	73, 94

T

Test Code Examples	157
Test Mode folder	159
Test Mode restrictions	158, 161
text	
adding to work areas	42, 83
trigonometric functions	163

V

variable, adjusting with a slider	35
vector functions	162
view	
3D Graphing	75
views	
3D Graphing	78

W

work areas	
adding text to	42, 83
working with documents	159