



TI-*nspire*[™]

Teacher Software Guidebook

This guidebook applies to TI-Nspire™ software version 3.9. To obtain the latest version of the documentation, go to education.ti.com/guides.

Important Information

Except as otherwise expressly stated in the License that accompanies a program, Texas Instruments makes no warranty, either express or implied, including but not limited to any implied warranties of merchantability and fitness for a particular purpose, regarding any programs or book materials and makes such materials available solely on an "as-is" basis. In no event shall Texas Instruments be liable to anyone for special, collateral, incidental, or consequential damages in connection with or arising out of the purchase or use of these materials, and the sole and exclusive liability of Texas Instruments, regardless of the form of action, shall not exceed the amount set forth in the license for the program. Moreover, Texas Instruments shall not be liable for any claim of any kind whatsoever against the use of these materials by any other party.

License

Please see the complete license installed in

C:\Program Files\TI Education\<<TI-Nspire™ Product Name>\license.

Adobe®, Adobe® Flash®, Apple®, Blackboard™, Chrome®, Excel®, Google®, Firefox®, Internet Explorer®, Java™, JavaScript®, Mac®, Microsoft®, Mozilla®, OS X®, PowerPoint®, Safari®, Vernier DataQuest™, Vernier EasyLink®, Vernier EasyTemp®, VernierGo!Link®, VernierGo!Motion®, VernierGo!Temp®, Windows®, and Windows® XP are trademarks of their respective owners.

© 2006 - 2014 Texas Instruments Incorporated

Contents

Important Information	2
Getting Started with TI-Nspire™ Teacher Software	13
Using the Welcome Screen	13
Exploring the Content Workspace	15
Exploring the Documents Workspace	16
Changing Language	18
Using the Content Workspace	20
Exploring the Content Workspace	20
Exploring the Resources Pane	21
Using the Preview Pane	23
Accessing Computer Content	24
Using Shortcuts	27
Working with Links	27
Using Web Content	30
Working with Connected Handhelds	35
Viewing Content on Connected Handhelds	35
Managing Files on a Connected Handheld	38
Sending Files to Handhelds	40
Checking for an OS Update	43
Installing an OS Update	44
Renaming Handhelds	46
Using Identify Selected to Locate Handhelds	47
Using the Transfer Tool	49
Transfer Tool Interface	49
Opening the Transfer Tool	52
Adding Files or Folders to the Transfer List	52
Removing Files or Folders from the Transfer List	53
Editing the Destination Folder	54
Deleting All Handheld Files and Folders	55
Starting a Transfer	56
Stopping File Transfers	57
Closing the Transfer Tool	58
Using the Documents Workspace	59

Exploring the Documents Workspace	59
Using the Documents Toolbox	60
Exploring Document Tools	60
Exploring the Page Sorter	61
Exploring the TI-SmartView™ Feature	62
Exploring Utilities	64
Exploring Content Explorer	66
Using the Work Area	68
Changing Document Settings	69
Changing Graphs & Geometry Settings	71
Working with TI-Nspire™ Documents	75
Creating a New TI-Nspire™ Document	75
Opening an Existing Document	76
Saving TI-Nspire™ Documents	77
Deleting Documents	78
Closing Documents	79
Formatting Text in Documents	79
Using Colors in Documents	81
Setting Page Size and Document Preview	81
Working with Multiple Documents	83
Working with Applications	84
Selecting and Moving Pages	87
Working with Problems and Pages	89
Printing Documents	91
Viewing Document Properties and Copyright Information	92
Working with PublishView™ Documents	95
Creating a New PublishView™ Document	96
Saving PublishView™ Documents	100
Exploring the Documents Workspace	102
Working with PublishView™ Objects	106
Working with TI-Nspire™ Applications	114
Working with Problems	118
Organizing PublishView™ Sheets	121
Using Zoom	127
Adding Text to a PublishView™ Document	127
Using Hyperlinks in PublishView™ Documents	130
Working with Images	137

Working with Video Files	140
Converting Documents	141
Printing PublishView™ Documents	144
Working with Lesson Bundles	145
Creating a New Lesson Bundle	145
Adding Files to a Lesson Bundle	147
Opening a Lesson Bundle	149
Managing Files in a Lesson Bundle	150
Managing Lesson Bundles	152
Packaging Lesson Bundles	154
Emailing a Lesson Bundle	155
Sending Lesson Bundles to Connected Handhelds	156
Capturing Screens	157
Accessing Screen Capture	157
Using Capture Page	158
Using Capture Selected Handheld	159
Viewing Captured Screens	160
Saving Captured Pages and Screens	161
Copying and Pasting a Screen	163
Capturing Images in Handheld Mode	163
Working with Images	167
Working with Images in the Software	167
Using Question in the Teacher Software	171
Understanding the Question Tools	172
Using the Teacher Tool Palette	173
Understanding the Configuration Tool	174
Formatting Text and Objects	175
Adding Images to Questions	176
Adding Questions	176
Responding to Questions	195
Understanding the Question Toolbar	195
Types of Questions	195
Responding to Quick Poll Questions	196
Submitting Responses	199

Calculator Application	201
Entering and Evaluating Math Expressions	202
CAS: Working with Measurement Units	209
Working with Variables	211
Creating User-defined Functions and Programs	212
Editing Calculator Expressions	216
Financial Calculations	217
Working with the Calculator History	219
Using Variables	223
Linking Values on Pages	223
Creating Variables	223
Using (Linking) Variables	228
Naming Variables	231
Locking and Unlocking Variables	233
Removing a Linked Variable	236
Graphs Application	237
What You Must Know	238
Graphing Functions	240
Manipulating Functions by Dragging	240
Specifying a Function with Domain Restrictions	243
Finding Points of Interest on a Function Graph	244
Graphing a Family of Functions	247
Graphing Equations	248
Graphing Conic Sections	248
Graphing Parametric Equations	251
Graphing Polar Equations	252
Using the Text Tool to Graph Equations	253
Graphing Scatter Plots	255
Plotting Sequences	256
Graphing Differential Equations	259
Viewing Tables from the Graphs Application	263
Editing Relations	263
Accessing the Graph History	265
Zooming/Rescaling the Graphs Work Area	266
Customizing the Graphs Work Area	267
Hiding and Showing Items in the Graphs Application	269
Conditional Attributes	270

Calculating Area Between Curves	272
Tracing Graphs or Plots	273
Introduction to Geometric Objects	275
Creating Points and Lines	277
Creating Geometric Shapes	282
Basics of Working with Objects	287
Measuring Objects	290
Transforming Objects	295
Exploring with Geometric Construction Tools	298
Animating Points on Objects	303
Adjusting Variable Values with a Slider	304
Labeling (Identifying) the Coordinates of a Point	306
Displaying the Equation of a Geometric Object	307
Using the Calculate Tool	308
3D Graphs	311
Graphing 3D Functions	311
Graphing 3D Parametric Equations	312
Rotating the 3D View	313
Editing a 3D Graph	314
Accessing the Graph History	314
Changing the Appearance of a 3D Graph	315
Showing and Hiding 3D Graphs	317
Customizing the 3D Viewing Environment	317
Tracing in the 3D View	318
Example: Creating an Animated 3D Graph	319
Geometry Application	321
What You Must Know	322
Introduction to Geometric Objects	324
Creating Points and Lines	326
Creating Geometric Shapes	331
Basics of Working with Objects	336
Measuring Objects	339
Transforming Objects	344
Exploring with Geometric Construction Tools	347
Using Geometry Trace	352
Conditional Attributes	353
Hiding Objects in the Geometry Application	355

Customizing the Geometry Work Area	355
Animating Points on Objects	356
Adjusting Variable Values with a Slider	357
Using the Calculate Tool	360
Lists & Spreadsheet Application	363
Creating and Sharing Spreadsheet Data as Lists	364
Creating Spreadsheet Data	366
Navigating in a Spreadsheet	369
Working with Cells	370
Working with Rows and Columns of Data	374
Sorting Data	378
Generating Columns of Data	379
Graphing Spreadsheet Data	382
Exchanging Data with Other Computer Software	386
Capturing Data from Graphs & Geometry	388
Using Table Data for Statistical Analysis	391
Statistics Input Descriptions	392
Statistical Calculations	394
Distributions	399
Confidence Intervals	405
Stat Tests	407
Working with Function Tables	412
Data & Statistics Application	415
Basic Operations in Data & Statistics	416
Overview of Raw and Summary Data	420
Working with Numeric Plot Types	421
Working with Categorical Plot Types	431
Exploring Data	440
Using Window/Zoom Tools	450
Graphing Functions	451
Using Graph Trace	456
Customizing Your Workspace	457
Adjusting Variable Values with a Slider	458
Inferential Statistics	461
Notes Application	463
Using Templates in Notes	464

Formatting Text in Notes	465
Using Color in Notes	466
Inserting Images	467
Inserting Items on a Notes Page	468
Inserting Comments in Notes Text	468
Inserting Geometric Shape Symbols	469
Entering Math Expressions in Notes Text	469
Evaluating and Approximating Math Expressions	471
Inserting Chemical Equations in Notes	473
Deactivating Math Expression Boxes	474
Changing the Attributes of Math Expression Boxes	475
Using Calculations in Notes	476
Exploring Notes with Examples	478
Data Collection	485
What You Must Know	486
About Collection Devices	487
Connecting Sensors	493
Setting Up an Offline Sensor	493
Modifying Sensor Settings	494
Collecting Data	496
Using Data Markers to Annotate Data	500
Collecting Data Using a Remote Collection Unit	503
Setting Up a Sensor for Automatic Triggering	505
Collecting and Managing Data Sets	507
Analyzing Collected Data	510
Displaying Collected Data in Graph View	515
Displaying Collected Data in Table View	517
Customizing the Graph of Collected Data	522
Striking and Restoring Data	530
Replaying the Data Collection	531
Adjusting Derivative Settings	533
Drawing a Predictive Plot	534
Using Motion Match	534
Printing Collected Data	535
Libraries	539
Creating Libraries and Library Objects	540
Private and Public Library Objects	540

Using Library Objects	541
Creating Shortcuts to Library Objects	542
Included Libraries	543
Restoring an Included Library	543
Getting Started with the Program Editor	545
Defining a Program or Function	546
Viewing a Program or Function	549
Opening a Function or Program for Editing	550
Importing a Program from a Library	550
Creating a Copy of a Function or Program	551
Renaming a Program or Function	551
Changing the Library Access Level	552
Finding Text	552
Finding and Replacing Text	552
Closing the Current Function or Program	553
Running Programs and Evaluating Functions	553
Getting Values into a Program	556
Displaying Information from a Function or Program	558
Using Local Variables	559
Differences Between Functions and Programs	561
Calling One Program from Another	562
Controlling the Flow of a Function or Program	563
Using If, Lbl, and Goto to Control Program Flow	564
Using Loops to Repeat a Group of Commands	566
Changing Mode Settings	570
Debugging Programs and Handling Errors	571
Using the TI-SmartView™ Emulator	573
Opening the TI-SmartView™ Emulator	573
Choosing a Keypad	575
Choosing Display Options	575
Working with the Emulated Handheld	576
Using the Touchpad	577
Using the Clickpad	577
Using Settings and Status	578
Changing TI-SmartView™ Options	579
Working with Documents	580
Using Screen Capture	581

Writing Lua Scripts	583
Overview of the Script Editor	583
Exploring the Script Editor Interface	584
Using the Toolbar	585
Inserting New Scripts	587
Editing Scripts	587
Changing View Options	588
Setting Minimum API Level	589
Saving Script Applications	589
Managing Images	590
Setting Script Permissions	592
Debugging Scripts	592
Using the Help Menu	595
Activating Your Software License	595
Registering Your Product	597
Downloading the Latest Guidebook	597
Exploring TI Resources	598
Running TI-Nspire™ Diagnostics	598
Updating the TI-Nspire™ Software	599
Updating the OS on a Connected Handheld	600
Viewing Software Version and Legal Information	601
Helping Improve the Product	602
Support and Service	603
Texas Instruments Support and Service	603
Service and Warranty Information	603
Index	605

Getting Started with TI-Nspire™ Teacher Software

TI-Nspire™ Teacher Software enables teachers to use PC and Mac® computers to perform the same functions as on a handheld. This document covers:

- TI-Nspire™ Teacher Software
- TI-Nspire™ CAS Teacher Software

Note: When there are differences between the software, those differences are described.

Using the Welcome Screen

By default, the Welcome Screen opens the first time you start the software after installation is complete. To begin working with documents, click an icon or link, or close this screen manually. Any normal action that takes place automatically, such as upgrade prompts or the ability to begin using connected handhelds, appears after you close the Welcome Screen.

Note: Depending on how your software was installed, you might see a Product Improvement screen the first time you start the software.

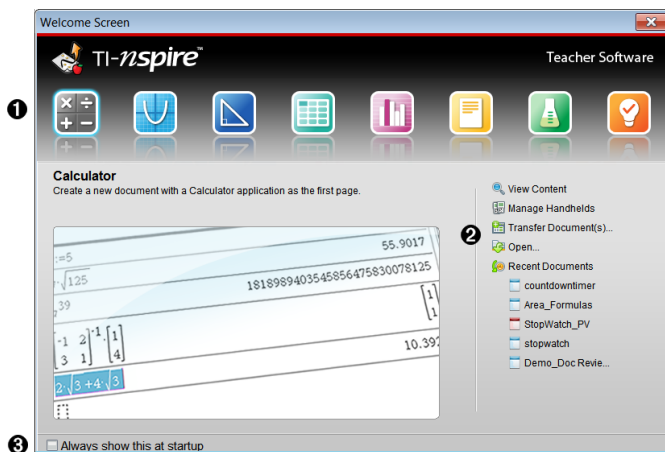

- 1 **TI-Nspire™ applications.** Click one of these icons to create a new

document with the selected application active. The applications are Calculator, Graphs, Geometry, Lists & Spreadsheet, Data & Statistics, Notes, Question, and the Vernier DataQuest™ application. When you click an icon, the Welcome Screen closes and the selected application opens in the Documents Workspace.

2 Quick Start links. Click one of these options to:

- Create a new document with the application you select as the first page.
- Create a new, blank document.
- Find and open an existing document.

Use the following links to:

- **View content.** Find content on your computer, the web, or connected handhelds.
- **Manage handhelds.** Use the Content Workspace to see every handheld connected to your computer as well as the status of each handheld.
- **Transfer documents.** Use the Content Workspace to send documents, folders, or new handheld OS files to connected handhelds.

3 Always show this at startup. Clear this check box to skip this screen when you open your software.

Closing the Welcome Screen

To access the default workspace and begin working with documents, click  to close the Welcome Screen. To open the Welcome screen again, click **Help > Welcome Screen**.

- In the TI-Nspire™ Teacher Software, the Content Workspace is displayed when you open the software for the first time.
- In the TI-Nspire™ Student Software, the Documents Workspace is the default workspace.

Note: The next time you open the software, the last workspace used is displayed.

Exploring the Content Workspace

The Content Workspace provides access to folders and files on your local drive, network drives, external drives, to files on connected handhelds, and links to web resources. Teachers can also use this workspace to create and manage lesson bundles.

Note: TI-Nspire™ Student Software users will not see the Content workspace.

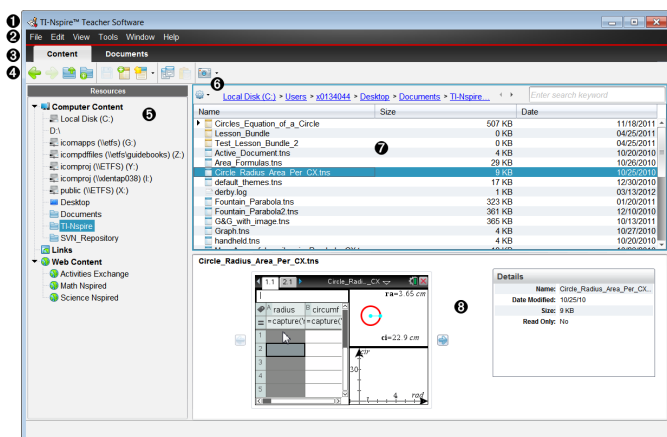

- 1 Title bar.** Shows the name of the software. The minimize, maximize, and close buttons are located in the right corner.
- 2 Menu bar.** Contains options used to work with files and to modify system settings. In the Content Workspace these are File, Edit, View, Tools, Window, and Help.
- 3 Workspace Selector.** Click these tabs to switch from the Content Workspace to the Documents Workspace.
- 4 Toolbar.** Contains shortcuts to tools used to create folders, save files, create lesson bundles, send files to handhelds, and copy/paste. Options available from the toolbar change depending on which workspace is open. In the Content workspace, the forward and back arrows function as they do in a web browser enabling you to go back and forth between locations.
- 5 Resources pane.** Enables you to locate and view files on your computer, access web links, and access files on connected handhelds. When you select a resource, the details for that resource are displayed in the content

pane.

- 6 Navigation bar.** Navigate to a location on your computer by clicking an item in the breadcrumb trail. When you select a resource, the options available are specific to that resource.
- 7 Content pane.** Shows the content for the resource selected. Use the content pane as you would a file manager to locate and view folders, lesson bundles, and TI-Nspire™ and PublishView™ documents on your computer or on connected handhelds. Click  to access options applicable to the selected folder or TI-Nspire™ document.
- 8 Preview pane.** Details about the selected file or folder are displayed in the bottom half of the space.

Exploring the Documents Workspace

Use the Documents Workspace to create or edit TI-Nspire™ and PublishView™ documents and work with applications and problems. The tools in the workspace are specific to working with open documents.

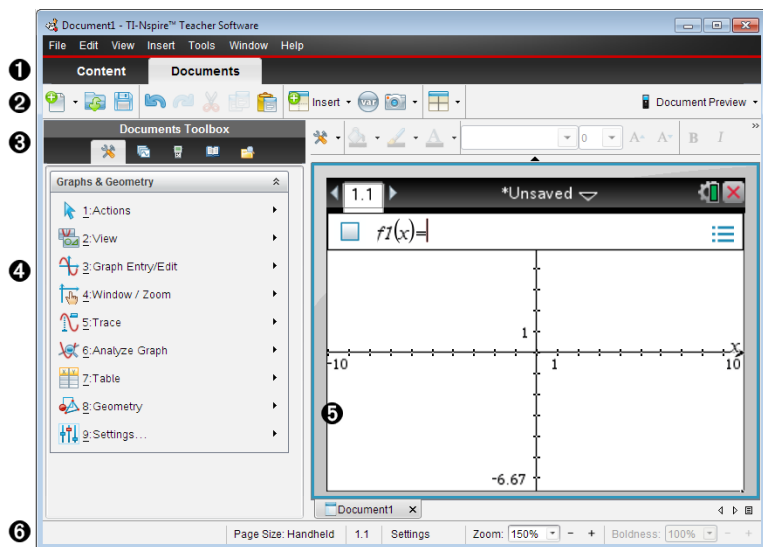

- 1 Workspace Selector.** Click a tab to switch between the Documents Workspace and the Content Workspace.

Note: These tabs are not shown in the TI-Nspire™ Student Software. The Document Workspace is the only available workspace.

- 2 Toolbar.** Contains shortcuts to frequently performed tasks such as creating new documents, opening existing documents, saving documents, inserting applications, inserting variables, and taking screen captures. The cut, copy, and paste icons are also located in the toolbar. At the right side, a **Document Preview** button lets you select Handheld or Computer preview.
- 3 Documents Toolbox.** Contains tools needed to work with TI-Nspire™ and PublishView™ documents. Use these tools to insert applications, use the page sorter to view TI-Nspire™ documents, open the TI-SmartView™ emulator, open Content Explorer, insert utilities such as math templates and the symbols from the catalog, and insert text and images into PublishView™ documents. Click each icon to access the available tools.
- 4 Toolbox pane.** Options for the selected tool are displayed in this area. For example, click the Document Tools icon to access tools needed to work with the active application. The tool for configuring questions opens in this space when you insert a question.
- 5 Work area.** Shows the current page of the active (selected) document. Lets you perform calculations, add applications, and add problems and pages. Only one document at a time is active. Multiple documents appear as tabs.
- 6 Status bar.** Provides information about the active document.

Understanding the Status Bar

The status bar provides information about the current document, and provides options that enable you to toggle between Handheld and Computer view and adjust how the document appears in the work area.

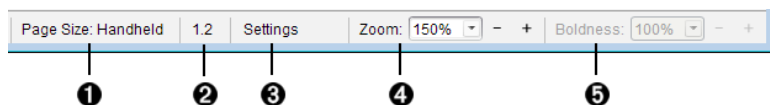

- 1 Page Size.** Shows the document's page size as Handheld or Computer. You can use the TI-Nspire™ **File** menu to convert a document from one page size to the other.
- 2 Problem/Page counter.** The first value represents the problem number of the active page, and the second value tells you the page

number within the problem. In the example, the counter reads **1.2**, indicating Problem 1, Page 2.

- Settings.** Double-click to view or change the Document Settings for the active document or to change the default Document Settings.
- Zoom.** Enabled in Handheld preview only (click **Document Preview** on the toolbar and select **Handheld**). Click ▼ and select a magnification value for the preview.
- Boldness.** Enabled in Computer preview only (click **Document Preview** on the toolbar and select **Computer**). Click ▼ and select a value to increase or decrease the boldness of text and other items.

Changing Language

Use this option to select a preferred language. You must restart the software for the language to take effect.

- Click **File > Settings > Change Language**.

The Choose a Language dialog box opens.

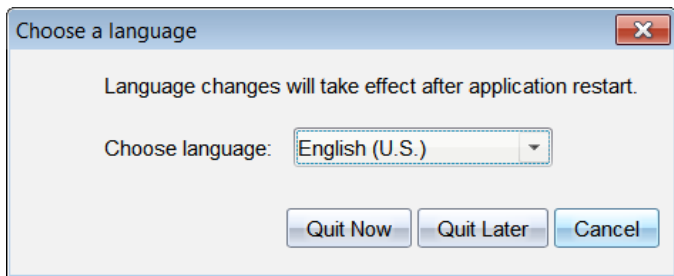

- Click ▼ to open the Choose language drop-down list.
- Select the desired language.
- Click **Quit Now** to close the software immediately. You will be prompted to save any open documents. When you restart the software, the language change is effective.

—or—

Click **Quit Later** to continue your work. The language change is not applied until you close and restart the software at a later time.

Note: If you select Simplified Chinese or Traditional Chinese as the language in the TI-Nspire™ software, you should see Chinese characters in the menus and dialogs. If your computer uses the Windows® XP operating system and you do not see Chinese characters, you may need to install the Windows® XP East Asian Language Support package.

Using the Content Workspace

The Content Workspace provides access and navigation to folders and files stored on your computer, network, and external drives, allowing you to open, copy, and transfer files to students.

Exploring the Content Workspace

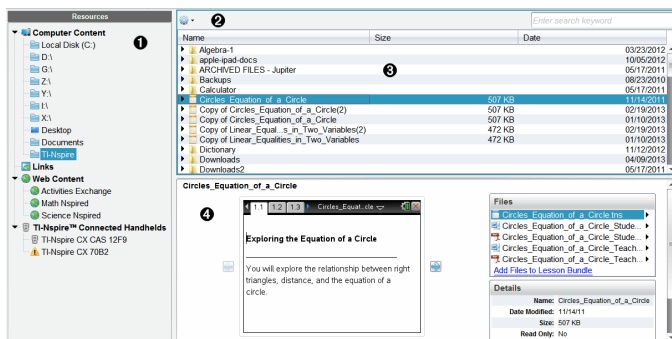

- 1 Resources pane.** Select content here. You can select folders and shortcuts on your computer, network drives, external drives, or web content. If you are using software that supports TI-Nspire™ handhelds, the Connected Handhelds heading is visible when handhelds are connected.

Note: You can add new links to your favorite Web sites in the Links section. You can access these new links in the Content pane. New links may not be added to the Web content section.

- 2 Navigation bar.** Navigate to any location on your computer by clicking an item in the breadcrumb trail. When you select a resource, the options shown are specific to that resource.
- 3 Content pane.** By default, the folders on your desktop are displayed. Use this space to locate and view files on your computer. You can locate and access files on a connected handheld if using software that supports handhelds. Use the top half of the space as you would a file manager. The Content pane is able to display the contents of only one selected item at a time. Avoid selecting more than one item at a time.
- 4 Preview pane.** Shows details about the selected file or folder.

Exploring the Resources Pane

Use the **Resources** pane to locate documents on a computer, access web content, and communicate with connected handhelds if using TI-Nspire™ software that supports connected handhelds.

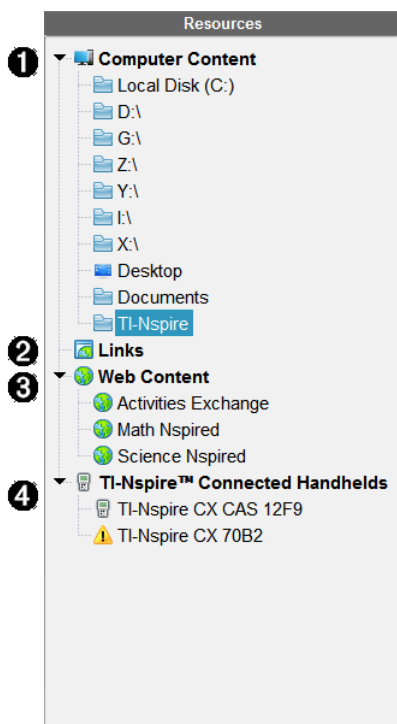

1 Computer Content. Enables navigation to all files on a computer, network drives, and external drives. Computer Content expands and collapses to provide access to the following default shortcuts:

- Local Disk
- External drives
- Network drives
- Desktop
- Documents or My Documents

When you select an item in Computer Content, the file structure appears in the Content pane. When you select a folder or supported

file, the detail is displayed in the Preview pane.

- 2 Links.** By default, links to Texas Instruments sites are listed. When you click Links, it shows a list of links in the Content pane. Then when you click a link there, it launches in your web browser. You can add your own links to this section. Links from the latest version of the TI-Nspire™ software are added when you upgrade.

Users located in the United States can search U.S. standards or textbooks by selecting the search option from Links.

- 3 Web Content.** Lists links to Texas Instruments sites that contain TI-Nspire™-supported activities. Web Content is available if you are connected to the Internet. You can save material you find on these sites to your computer and share items through the Computer Content pane or Connected Handhelds if using software that supports handhelds. You cannot save links to websites in the Web Content section.

Note: The web content that is available varies depending on region. If there is no online content, this section is not visible in the Resources pane.

When you select an item in Web Content, the list of activities is displayed in the Content pane, and a preview of the selected activity is displayed in the Preview pane.

- 4 Connected Handhelds.** Lists handhelds connected to your computer. Click the Connected Handhelds label to view information about each handheld in the Content pane. To see folders and files on a specific handheld, click the handheld name. A warning sign next to a handheld name indicates that the OS on the handheld does not match the software version. The handheld OS release version must match the TI-Nspire™ software release version to work in a classroom environment. Move your mouse over the warning sign to open a tool tip for more information.

Note: Connected Handhelds are not shown if there are no handhelds connected or if you are using TI-Nspire™ Navigator™ NC Teacher Software.

Using the Preview Pane

Lesson Bundle Example

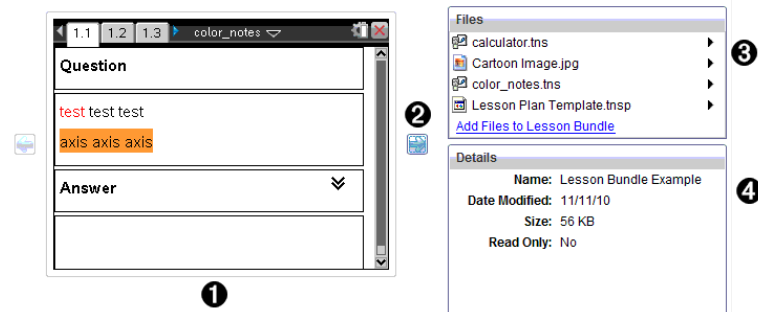

- 1 A thumbnail preview of the selected folder, .tns file, file-type icon, or lesson bundle. Double-click a file-type icon to open the file in its associated application.

Note: If a lesson bundle is empty and this space is blank, you have the option to add files.

- 2 If a TI-Nspire™ document has multiple pages, use the forward arrow  to preview the next page. The backward arrow becomes active so you can move backward through the pages. If working with a lesson bundle, you can choose to preview a TI-Nspire™ document within the bundle by this method.
- 3 If a lesson bundle is selected, the **Files** dialog box opens above the **Details** window listing the files in the lesson bundle. Double-click any file in a lesson bundle to open the file in its associated application.

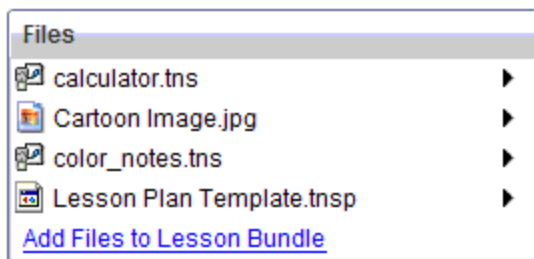

- 4 If a folder is selected, the **Details** window shows the name of the folder, the path where the folder is located, and the date modified.

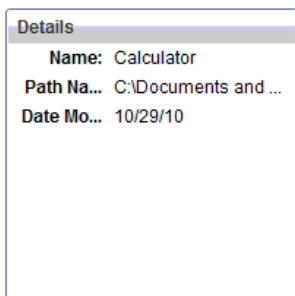

For document files and lesson bundle files, the **Details** window shows the name, the date the file was modified, the file size, and whether or not the file is read only.

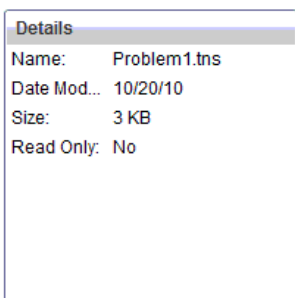



Accessing Computer Content

Computer Content provides access to all information stored on your computer, network, and external drives.

Using the Navigation bar

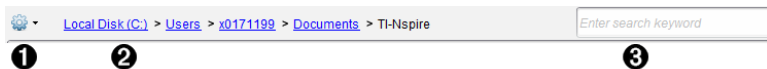
The Content pane Navigation bar provides tools needed to locate folders and files.



- 1**  **Options.** Click ▼ to open the menu to access options for working with files and folders.
- 2** **Current path:** Contains a clickable breadcrumb trail of the current

location. Click a breadcrumb to navigate to any section in the path.

- 3 **Search.** Enter a search keyword and press **Enter** to find all files within the selected folder containing that word.

Filtering Computer Content

Use this filtering option for easy access and selection of your teaching content. You can select show TI-Nspire™ content only or to show all content.

1. Select a folder in Computer Content in the Resources pane.
2. From the Menu bar, select **View > Filter by**.
3. Choose one of the following options.
 - **Show TI-Nspire™ content only**
 - **Show all content**

Mapping a Network Drive

Complete the following steps to map a network drive.

1. Select Computer Content from the Resources list.

2. Click , and then click **Create Shortcut**.

The Add Shortcut location to Content dialog box opens.

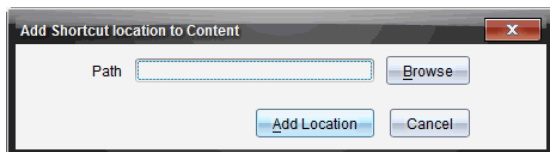

3. Click **Browse**.

Note: You can also type the full path name for the network drive.

The Select Shortcut Folder dialog box opens.

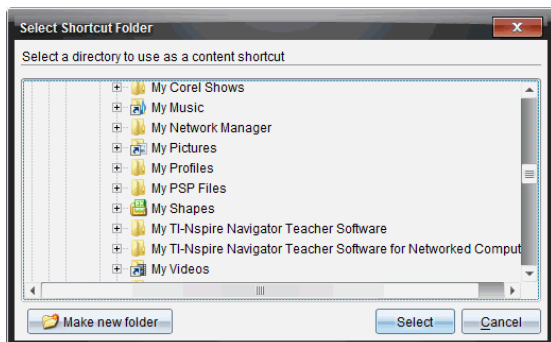

4. Navigate to the network drive.
5. Click **Select**.
6. Click **Add Location**.

The Please enter network drive credentials dialog box opens.

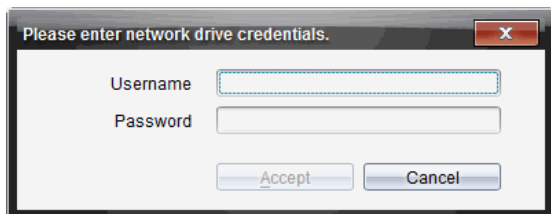

7. Type the username and password given to you by your system administrator.
8. Click **Accept**.

The network drive is added to the list of folders under the Computer Content heading in the Resources pane.

Accessing a Secured Network Drive

If access to a network drive requires authentication, complete the following steps to access secured network.

1. Click the drive you want to access in the Resources pane.

The Please enter network drive credentials dialog box opens.

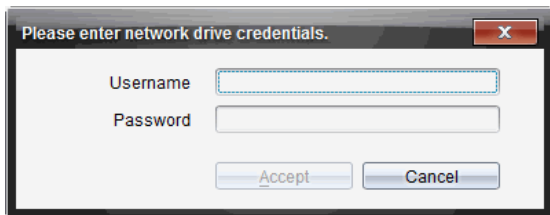

2. Type your username and password.
3. Click **Accept**.

Using Shortcuts

Use this option to add folders or lesson bundles containing frequently used files to the Computer Content list.

Adding a Shortcut

To add a shortcut to a folder containing files you access often:

1. Navigate to the folder where the files are located.

2. Click , and then click **Create Shortcut**.

The folder is added to the list of folders under Computer Content in the Resources pane.

Deleting a Shortcut

To delete a shortcut:

1. From the Computer Content list, select the folder to be deleted.
2. Right-click the selected folder, and then click **Remove Shortcut**.

The folder is removed from the list of shortcuts.

Note: You cannot remove default shortcuts.





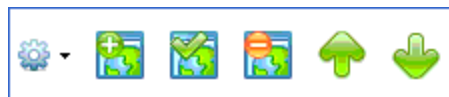

Working with Links

By default, the Links list contains a list of links to Texas Instruments websites. Click a link to launch your web browser and access the website.

Using the Links Toolbar

When you select Links in the Resources pane, the tools on the navigation bar are specific to working with links. Use these tools to add, edit, or delete links from the list. You can also move a link up or down in the list.



	Options. Click ▼ to open the menu to access options for working with links.
	Click this icon to add a link to the list.
	Select an existing link, and then click this icon to edit the link's attributes. You cannot edit a default link.
	Click this icon to delete a link. You cannot delete a default link.
	Select a link and click this icon to move the link up in the list.
	Select a link and click this icon to move the link down in the list.

Adding a Link

Complete the following steps to add a link to the list of Links in the Resource pane.

1. Click  .

The Add Link dialog box opens.

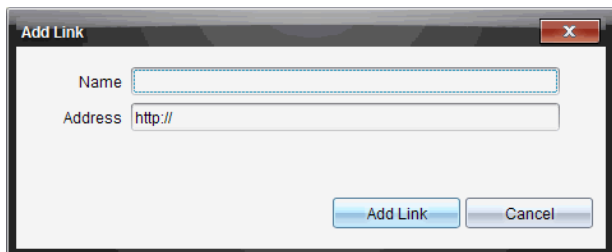

2. Type the name of the link.
3. Type the URL in the Address field.
4. Click **Add Link**.

The link is added to the bottom of the list of existing links.

Editing an Existing Link

Complete the following steps to edit an existing link.

1. Select the link you want to change.



2. Click .

The Edit Link dialog box opens.

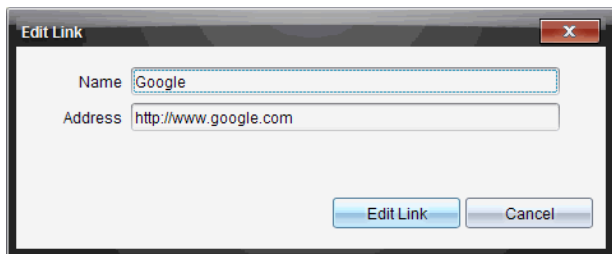

3. Make needed changes to the name of the link or to the URL.
4. Click **Edit Link**.

The changes are applied to the link.

Removing a Link

Complete the following steps to delete a link.

1. Select the link you want to delete.

2. Click .

The confirmation dialog box opens.





3. Click **Remove**.

The link is removed from the list.

Note: You cannot delete a default link.

Moving Links Up or Down in the List

You can change the order of the links in the list to suit your needs.

- ▶ Click  to move a selected link up one place in the list.
- ▶ Click  to move a selected link down one place in the link.
- ▶ Click , and then select **Move to Top of List** to relocate a selected link to the top of the list.
- ▶ Click , and then select **Move to Bottom of List** to relocate a selected link to the bottom of the list.

Using Web Content

Web Content provides links to online materials on Texas Instruments websites. You can save material found on these websites to your computer and share them using the Computer Content pane and Connected Handhelds.

Information provided for each activity includes the name of the activity, the author, the date the activity was posted, the size of the file, and the source.

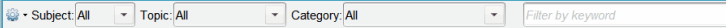
1 

2

Name	Author	Date Posted	Size	Source
Forensics with	Texas Instruments	4/1/13	934 KB	Activities Exchange
Forensics with	Texas Instruments	4/1/13	986 KB	Activities Exchange
Forensics with	Texas Instruments	4/1/13	834 KB	Activities Exchange
NASA - Diving Down	NASA and TI	3/26/13	1585 KB	Activities Exchange
Exploring Ellipses and	Texas Instruments	2/25/13	1477 KB	Activities Exchange
Exploring Hyperbolas	Texas Instruments	2/25/13	1367 KB	Activities Exchange
Exploring Parabolas	Texas Instruments	2/4/13	1065 KB	Activities Exchange
The Radian Sector	Texas Instruments	1/24/13	814 KB	Activities Exchange
Blood Pressure	Texas Instruments	1/8/13	820 KB	Activities Exchange
3D Parametric	Texas Instruments	1/8/13	1090 KB	Activities Exchange
Health and Nutrition -	Texas Instruments	12/4/12	8594 KB	Activities Exchange
Health and Nutrition -	Texas Instruments	12/4/12	363 KB	Activities Exchange
Stay Tuned Lab Sound	Lauren Jensen	9/1/12	168 KB	Activities Exchange

3

4 **Forensics with TI-Nspire™ - Case 2: Bouncing Back**
 In this activity, students will be using the motion sensor as a sonar detector, through air to locate and identify a missing object in a box.

5 **Save this Activity to Computer**

Files

- Case_2_Bouncing_Back.tns
- Case_2_Bouncing_Back_Student.pdf
- Case_2_Bouncing_Back_Teacher.pdf

Details

Name: Forensics with TI-Nspire™
 Author: Texas Instruments
 Date Posted: 4/1/13
 Size: 986 KB
 Source: Activities Exchange
 Activity Time: 45 Minutes
 Device: TI-Nspire™ Navigator™ TI-Ns...

- 1 Navigation toolbar.
- 2 Column headings.
- 3 List of available activities.
- 4 List of the files contained in the activity.
- 5 Details about the selected activity.

Note: An Internet connection is required to access Texas Instruments websites.

Sorting the List of Activities

Use the column headings to sort the information in the list of activities. By default the list is displayed in alphabetical order by Name.

- Click the Name heading to list activities in reverse alphabetical order. Click the heading again to return to A to Z order.
- Click the Author heading to list the activities in alphabetical order by author name.
- Click the Date Posted heading to list the activities in order from newest to oldest or from oldest to newest.
- Click the Size heading to list the activities according to file size.
- Click the Source heading to list the activities in order by source.
- Right-click the column heading row to customize displayed column headings.

Filtering the List of Activities

By default, all available activities are listed in the Content pane. Options on the Navigation bar enable you to filter the activities by subject, topic, and category. You can also search for an activity using a keyword search.

To find all activities related to a particular subject:

1. In the Subject field, click ▼ to open the drop-down list.
2. Select a subject.
All activities related to the selected subject are listed.
3. To narrow the search, click ▼ in the Topic field to view and select a topic related to the subject selected.
4. Use the Category field to narrow the search even further. Click ▼ to select a category related to the selected subject and topic.

Using Keywords to Search for an Activity

Complete the following steps to search for an activity using a keyword or phrase.

1. Type a keyword or phrase in the Filter by Keyword field.
2. Press **Enter**.
All activities that contain the keyword or phrase are listed.

Opening an Activity

1. Select the activity you want to open.
2. Click , and then select **Open**.

The Open Activity dialog box opens with a list of all documents related to the selected activity.

You can open a .tns or .tsnp file in the TI-Nspire™ software. Other files such as Microsoft® Word and Adobe® PDF files open in their respective applications.

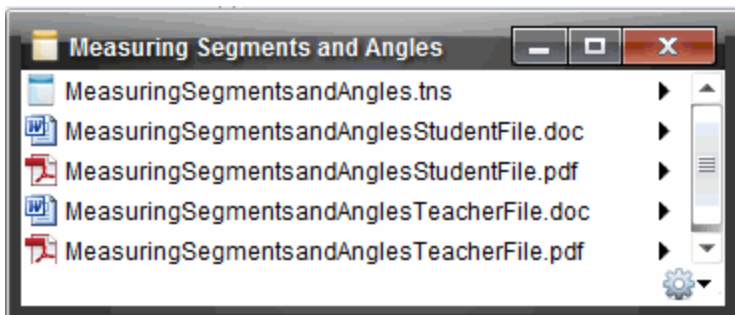

3. Select the file and click , and then select **Open**.
 - The .tns file opens in the Documents Workspace.
 - The .doc or .pdf file opens in its associated application.

Saving an Activity to Your Computer

Complete the following steps to save an activity to your computer.

1. Select the activity you want to save. The file details are displayed in the bottom half of the window.

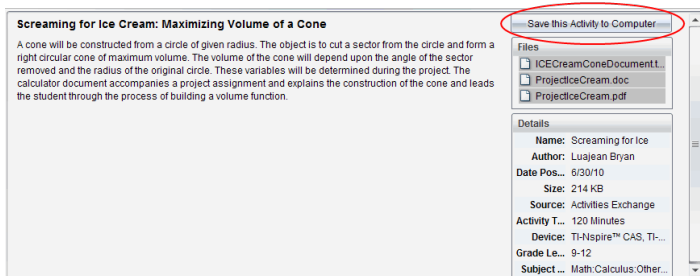

2. Click **Save this Activity to Computer** in Preview pane, above Files.

Note: You can also right-click on the selected activity and choose **Save to Computer**.



The Save Selected files dialog box opens.

3. Navigate to the folder where you want to save the file.
4. Click **Save**.

The activity is saved to your computer as a lesson bundle.

Copying an Activity

Complete the following steps to copy an activity. Once the activity is copied to the Clipboard, you can paste the activity into a folder on your computer, and then drag the activity to your list of shortcuts in the Local Content pane.

1. Click the activity you want to copy to select it.
2. Use one of the following methods to copy the activity to the Clipboard:
 - Select the activity and drag it to a folder in the Local Content list.
 - Click , and then click **Copy**.
 - Right-click on a file in the Files list, and then click **Copy**.
 - Click  (Copy icon), which is located in the toolbar.

The activity is copied to the Clipboard.

3. Open a folder on your computer, and then click **Edit > Paste** to copy the activity to the selected folder.

Working with Connected Handhelds

The TI-Nspire™ software enables you to view content, manage files, and install operating system updates on handhelds connected to the computer.

To use the features described in this chapter, handhelds must be turned on and connected by one of these means:

- TI-Nspire™ Docking Station or TI-Nspire™ CX Docking Station
- TI-Nspire™ Navigator™ Cradle and access point
- TI-Nspire™ CX Wireless Network Adapter and access point
- TI-Nspire™ CX Wireless Network Adapter - v2 and access point
- A direct connection through a standard USB cable

Note: The tasks in this section can only be performed using TI-Nspire™ handhelds. In order to enable wireless connectivity, the TI-Nspire™ Navigator™ Teacher Software for Handhelds and the OS installed on the TI-Nspire™ handhelds must be version 3.9 or later.

Viewing Content on Connected Handhelds

When you select a handheld in the Resources pane in the Content Workspace, all files and folders on the handheld appear in the Content pane. To preview the document contents, select **Click here to preview document** in the Preview pane.

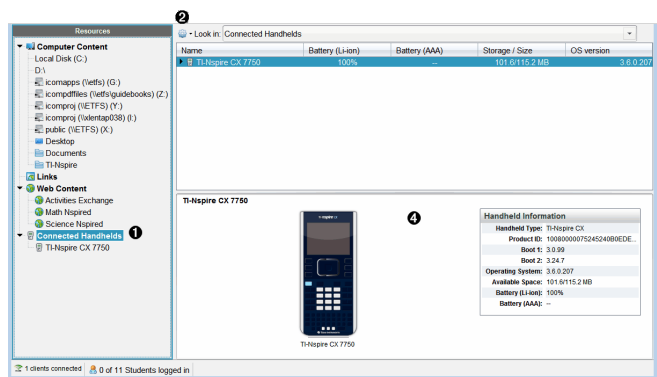

❶ **Connected Handhelds** - Lists all handhelds that are connected and turned on.

Note: A warning symbol next to the handheld name indicates that the OS installed on the handheld does not match the software version installed on the computer and that an OS update is needed.

❷ **Options** - Available options vary depending on the task you select under Resources.

❸ **Content pane** - When Connected Handhelds is selected, the Content pane shows details about handhelds that are connected and turned on:

- **Name**
- **Battery (Li-ion)** - Li-ion (rechargeable) battery charge (Critical 2%, 25%, 50%, 75%, 100%, or "--" to indicate no battery is present).
- **Battery (AAA)** - AAA battery charge (Critical 2%, 25%, 50%, 75%, 100%, or "--" to indicate no battery is present).
- **Storage Size**
- **OS Version**

❹ **Preview pane** - Provides information on a handheld when you click Connected Handhelds in the Resources pane and then a handheld in the Content pane. If you select a TI-Nspire™ file in the Content pane, the Preview pane shows a preview available for that file.

- **Handheld Type:** Names of handhelds.
- **Product ID:** Handheld product identification.
- **Boot 1:** Internal bootstrap that performs lower level operation for booting up device.
- **Boot 2:** External bootstrap that performs lower level operation for booting up device.
- **Operating System:** The operating system in use.
- **Available Space:** The amount of space left and available on the handheld.

When you select a handheld, all files and folders on the handheld appear in the Content pane. When a file or folder is selected, the details are displayed in the Preview pane. Click the icon to preview the document.

Name	Size
7th Period Geometry	
AlgebraI	
AlgebraII	
Examples	
00 Getting Started.tns	9 KB
01 Percentage Explorer.tns	12 KB
02 Introducing Functions.tns	8 KB
03 Linear Equations Explorer.tns	10 KB
04 Systems of Equations Explorer.tns	11 KB
05 Introducing Geometry.tns	19 KB

Details about the selected folder or file are shown in the Preview pane.

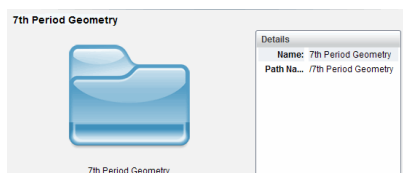

Details for selected folder

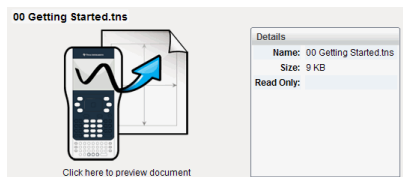

Details for selected file

- ▶ To view the files in a folder, double-click the folder name in the Content pane. The files in the folder are listed in the Content pane.
- ▶ To preview the contents of a .tns file, select **Click here to preview document** in the Preview pane.

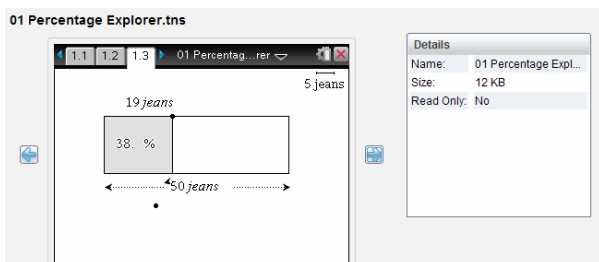

Managing Files on a Connected Handheld

When working with files on connected handhelds in the Content Workspace,

use the Options menu  or the context menu to manage files.

Note: If you select a file type that is not supported on the handheld, some selections in Options menu are not active.

Option	How it Works
Open	Open a file on a connected handheld: <ul style="list-style-type: none">• Click the file you want to open.• Click Open. The document opens in the Documents Workspace.
Save to Computer	Save a copy of the selected file on your computer: <ul style="list-style-type: none">• Click the file you want to save.• Click Save to Computer. The Save Selected Files dialog box opens.• Navigate to the folder where you want to save the file.• Click Save.
Copy/Paste	Create a copy of a file: <ul style="list-style-type: none">• Click the file you want to copy.• Click Options > Copy to copy the file to the Clipboard.• To paste the file in another location, navigate to the new location, and then click Options > Paste. <p>Note: If you don't select a new location, the copied file is pasted with a new name "Copy of ..."</p>
Delete	Delete a file on a connected handheld: <ul style="list-style-type: none">• Click the file you want to delete.• Click Delete.• Click Yes when the Warning dialog box opens. Click No to cancel.
Refresh	To refresh the list of files, click Options > Refresh .

Option	How it Works
Rename	To rename a file on a connected handheld: <ul style="list-style-type: none"> • Click the file you want to rename. • Click Options > Rename. • Type the new name and press Enter.
Up a Level	Go up a level in the folder hierarchy. This option is available when you select a file inside a folder.
New Folder	Create a new folder: <ul style="list-style-type: none"> • Click New Folder. • Type a name for the new folder. • Press Enter.

Opening Documents on a Connected Handheld

To open a document on a connected handheld in the TI-Nspire™ software:

1. Ensure the handheld is connected to your computer.
2. Click  to open Content Explorer.
The connected handheld name is listed in the Connected Handhelds pane.
3. Double-click the handheld name.
The folders and documents on the handheld are listed.
4. Navigate to the document you want to open, and then double-click the file name.
The document opens in the Documents Workspace.

Saving Files to a Connected Handheld

When you save a file from your computer to a handheld, files are converted to TI-Nspire™ documents (.tns files). (See *Sending Files to Handhelds*)

To save a file on your computer to a connected handheld:

1. Ensure the handheld is connected to your computer.
2. Click  to open Content Explorer.

The folders and files on your computer are listed in the Computer pane.

3. Navigate to the folder or file you want to save to the handheld.
4. Click the file to select it.
5. Drag the file to a connected handheld listed in the Connected Handheld pane.

The file is saved to the connected handheld.

Note: To save the file in a folder on the handheld, double-click the handheld name to list the folders and files, and then drag the file to a folder on the handheld.

If the file already exists on the handheld, a dialog box opens asking if you want to replace the file. Click **Replace** to overwrite the existing file. Click **No** or **Cancel** to abandon the save.

Sending Files to Handhelds

You can transfer activities, folders, lesson bundles, and supported files from a computer to connected handhelds, from one connected handheld to another, or from one connected handheld to all connected handhelds.

Items you can transfer include:

- Folders
- Supported files
 - .tcc
 - .tco
 - .tilb
 - .tnc
 - .tno
 - .tns

Sending an Activity to a Connected Handheld

In the Content Workspace, you can send an activity from the Web Content link to connected handhelds.

1. Use the Workspace selector to select the Content Workspace.
2. Click Web Content in the Resources pane.
3. Click the activity you want to send to connected handhelds.

4. Use one of the following options to send the file to the selected handhelds:
 - Drag the file to the Selected Handhelds label to transfer to the file to all connected handhelds. To transfer the file to a specific handheld, drag the file to a specific handheld name.
 - To transfer the file using Transfer Tool:

Note: You cannot use the Transfer Tool to transfer files to handhelds while a class is in session.
 5. From the toolbar, click , and then select **Send to Connected Handhelds**.
- or–

Click , and then select **Send to Connected Handhelds**.
The Transfer Tool opens.

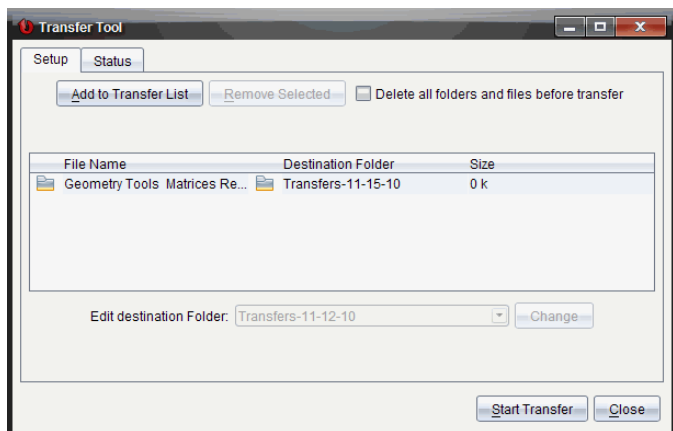

6. Select the file, and then click **Start Transfer**.
The selected files and folders are transferred to the selected handhelds.
7. When the transfer is complete, close the Transfer Tool.

Sending Files to all Connected Handhelds

You can send a file to all connected handhelds when a class is not in session. To transfer files or folders from a connected handheld or from the computer to all connected handhelds, complete the following steps:

1. Use the Workspace selector to select the Content Workspace.
2. Select the files or folders you want to transfer from the Resources pane.

Note: You can choose files from Computer Content, Web Content, or Connected Handhelds.

3. Click  , and then click **Send to Connected Handhelds**.

The Transfer Tool window opens.

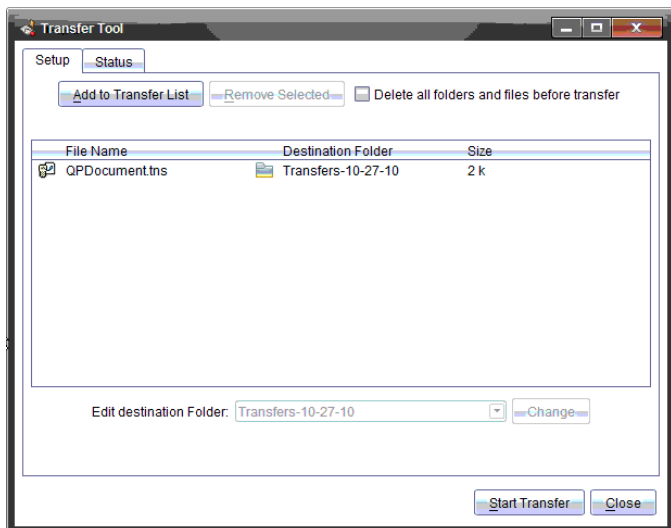

4. Click **Start Transfer**.

Note: To add additional files to the transfer list, click **Add to Transfer List**.

The selected files and folders are transferred to the connected handhelds. By default, the files are transferred to a folder on the handheld titled *Transfers-mm-dd-yy*.

Transferring Files Between Handhelds

If multiple handhelds are connected, you can send a folder or file from one handheld to another handheld in the Connected Handhelds list in the Resources pane.

1. Use the Workspace selector to select the Content Workspace.
2. In the Resources pane, click the handheld that contains the files you want to transfer. The files on the handheld are listed in the Content pane.
3. Click the folder or file you want to send.

4. Drag the file to another handheld in the Connected Handhelds list.

Note: You can also copy and paste a file from one handheld to another.

Checking for an OS Update

When handhelds are connected, you can check for OS updates from the Content Workspace or from the Documents Workspace.

Note: Your computer must be connected to the Internet.

1. Show all connected handhelds.
 - In the Content Workspace, click **Connected Handhelds** in the Resources pane.
 - In the Documents Workspace, open the Content Explorer and click **Connected Handhelds**.
2. Click the handheld you want to check, and then right-click and select **Check for OS Update**.
 - If the operating system is current, the Check for Handheld OS Update dialog box opens indicating that the operating system on the handheld is current.

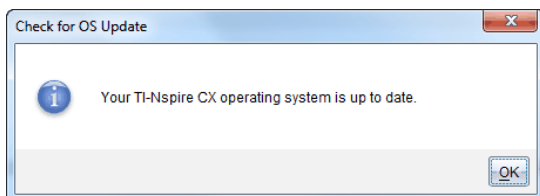

- If the operating system is not current, the TI-Nspire™ software prompts you to install the latest OS now, with the option to download the OS to your computer.

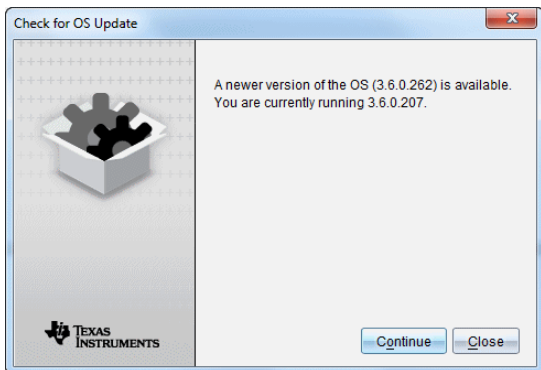

3. Click **Close** to close the dialog box, or click **Continue** and follow the prompts to install the OS on the handheld.

Installing an OS Update

Note: To avoid losing unsaved data, close all documents on the handheld before updating its operating system (OS). Updating the OS does not replace or remove previously saved documents.

The OS on a new handheld comes bundled with the installer, which places the OS in a default location such as: C:\mydocuments\TI-Nspire\downloads.

Go to education.ti.com/latest to download the latest OS files.

Note: You can install OS updates on connected handhelds from the Content Workspace at any time.

Updating the OS on a Single Handheld

1. Ensure that your computer is connected to the internet.
2. Show all connected handhelds by clicking the arrow next to **TI-Nspire™ Connected Handhelds** in the Resources pane.

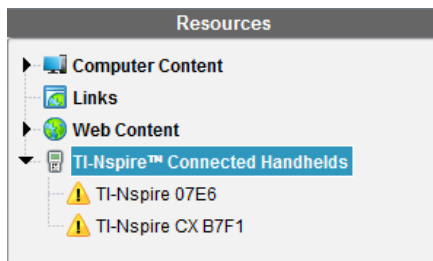

Note: The  symbol indicates either:

- A student's handheld needs an OS update.

–or–

- A student's handheld has a newer OS than the teacher's.
3. Hover your mouse over the TI-Nspire™ handheld you want to update, and then right-click.
 4. Click **Check for OS Update**.

The Check for OS Update dialog box opens.

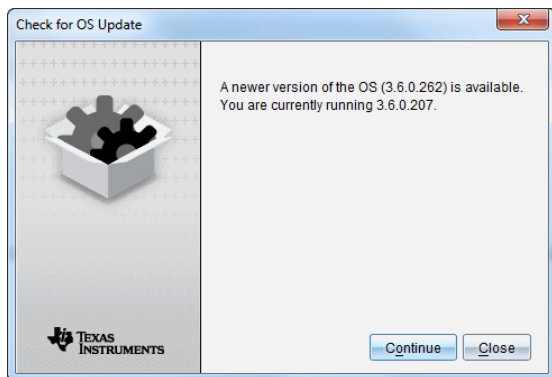

5. Click **Close** to cancel the installation, or click **Continue** and follow the prompts to install the OS on the handheld.

When the update is complete, the handheld restarts automatically.

Updating the OS on Multiple Handhelds

Note: To avoid losing unsaved data, close all documents on the handheld before updating its operating system (OS). Updating the OS does not replace or remove previously saved documents.

1. Click **TI-Nspire™ Connected Handhelds** in the Resources pane.
2. Select all handhelds you want to update in the Content Pane.
3. Click **Tools > Install OS**.

The OS Installation dialog box opens.

4. Click **Add OS file**.

The Add to Transfer List dialog box opens.

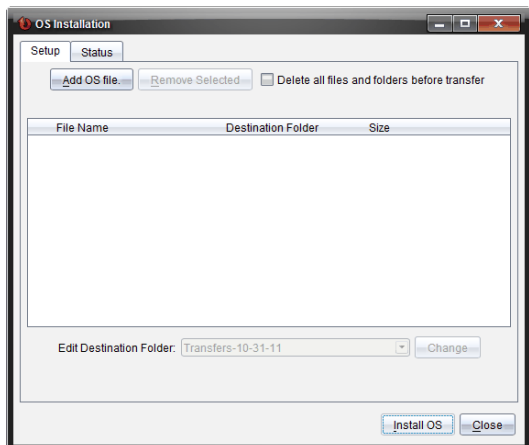

5. Select the applicable OS files.
 - To upgrade a TI-Nspire™ CX handheld, select TI-Nspire.tco.
 - To upgrade a TI-Nspire™ CX CAS handheld, select TI-Nspire.tcc.
 - To upgrade a TI-Nspire™ handheld, select TI-Nspire.tno.
 - To upgrade a TI-Nspire™ CAS handheld, select TI-Nspire.tnc.
6. Click **Select**.

The OS Installation redisplay with your selected OS files.
7. Click **Install OS**.

The OS version information updates, and the Select OS Handheld File dialog redisplay for further selection.

Renaming Handhelds

You can rename the handhelds from the Content Workspace.

Note: Renaming a handheld does not affect student login information.

1. Right-click the handheld name in the Content pane.
2. Click **Rename**.
3. Type the new name.
4. Press **Enter** to go to the next name to change.

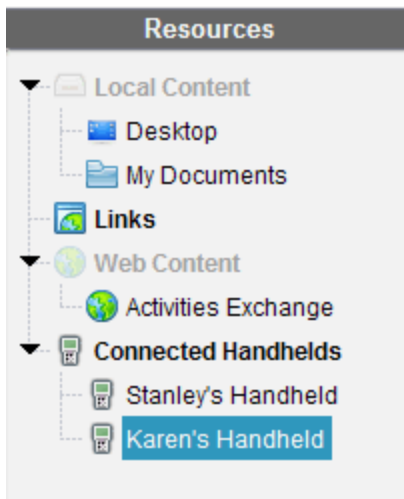

5. To exit the Edit mode, click an area of the screen outside the handheld names. You will also leave the Edit mode after you press **Enter** on the last name you edit.

Using Identify Selected to Locate Handhelds

If you are using the TI-Nspire™ Docking Station or the TI-Nspire™ CX Docking Station, use this feature to locate handhelds.

1. Be sure that the handhelds are turned on and that the docking station is connected to your computer.
2. Use the Workspace selector to select the Content Workspace.
3. Click **Tools > Identify Selected Handheld/Lab Cradle**.

Note: You can also right-click the handheld name in the Content pane, and then select **Identify Selected Handheld/Lab Cradle**.

Both LED lights on the docking station under the slot where the handheld is located will blink for 30 seconds.

Using the Transfer Tool

When a class is not in session, you can transfer files or folders containing files from your computer to connected TI-Nspire™ handhelds using the Transfer Tool. With the Transfer Tool, you can transfer one or more files or documents to one or more handhelds without requiring students to log in.

Files	File Extensions
Operating systems (OS)	.tcc (TI-Nspire™ CX CAS handhelds) .tco (TI-Nspire™ CX handhelds) .tnc (TI-Nspire™ CAS handhelds) .tno (TI-Nspire™ handhelds)
Documents	.tilb (TI-Nspire™ Lesson Bundle) .tns (TI-Nspire™ document)

Notes:

- You can transfer more than one operating system file at a time; however, you can only transfer one operating system file with the same file extension at a time. For example, you can transfer a .tcc and a .tco file at the same time, but only one .tcc file at that time.

Transfer Tool Interface

The Transfer Tool dialog box contains a Setup tab and a Status tab.

Setup Tab

The Setup tab allows you to select files to transfer and a destination folder.

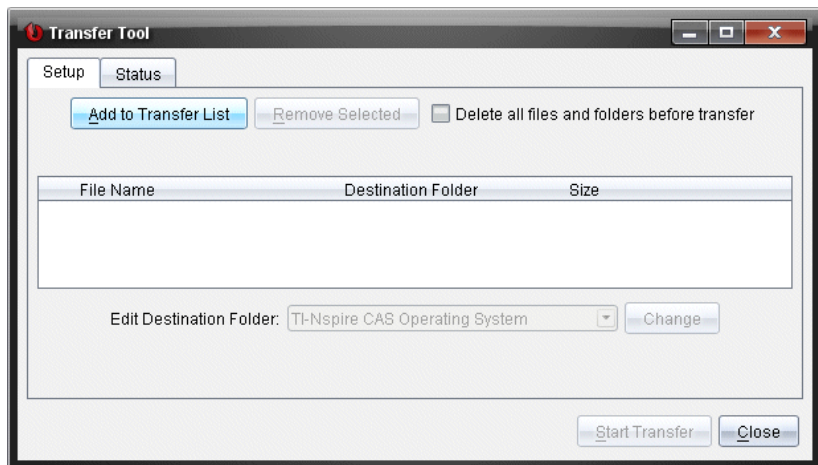

The Setup tab includes the following features:

Feature	Description
Add to Transfer List	Click to add files or folders with files to the Transfer List. The Transfer List displays the File Name (or folder name), the DestinationFolder, and the Size (in KB) of the file or folder you want to transfer.
Remove Selected	Click to remove selected files and folders from the Transfer List. This option becomes active when you add files to the Transfer List.
Delete all files and folders before transfer	Select to clear all files and folders on a handheld before a file transfer.
Edit Destination Folder	Select to change the destination folder for the files you want to transfer.

Status Tab

The Status tab is only active when a transfer is in progress.

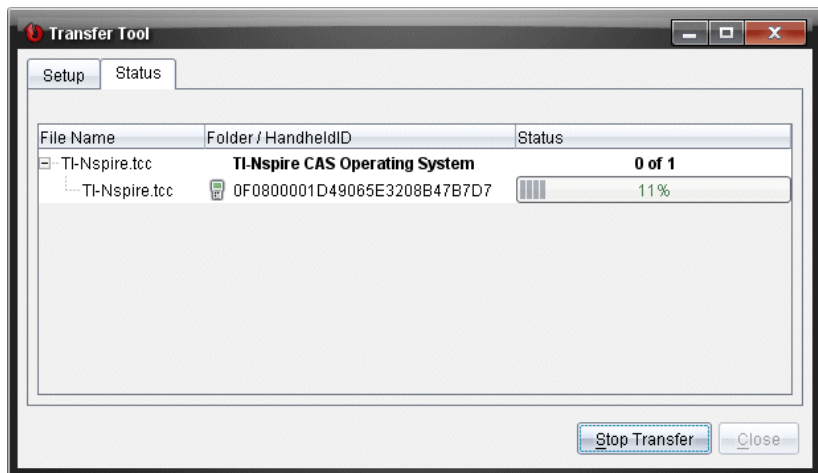

When you start a transfer, the Transfer Tool automatically switches to the Status tab. The Status tab allows you to view the progress and status of files as they transfer and provides the following information:

Information	Description
File Name	Indicates the file name and extension.
Folder/Handheld ID	Indicates the destination folder and the handheld ID.
Status	Indicates the completion status, the progress bar, or any error message. Error messages include: <ul style="list-style-type: none"> • Low battery • Wrong handheld type • Memory full • Lost connectivity

Notes:

- If no transfers are active, the following message is displayed: *“No transfers are active. Use the Setup tab to configure and start the transfer.”*
- During a transfer, no options are available on the Setup tab.

Opening the Transfer Tool

Before you can use the Transfer Tool, you must end any running class sessions.

To open the Transfer Tool, use one of these methods:

► Click **Tools > Transfer Tool**.

► Click , and then select **Send to Connected Handhelds**.

The Transfer Tool opens the Setup tab.

Adding Files or Folders to the Transfer List

You must add files or folders to the Transfer List before you can start a transfer.

Note: You can only add a folder that contains files to the Transfer List.

To add files or folders to the Transfer List:

1. In the Transfer Tool dialog box, click **Add to Transfer List**.

The Add to Transfer List dialog box opens.

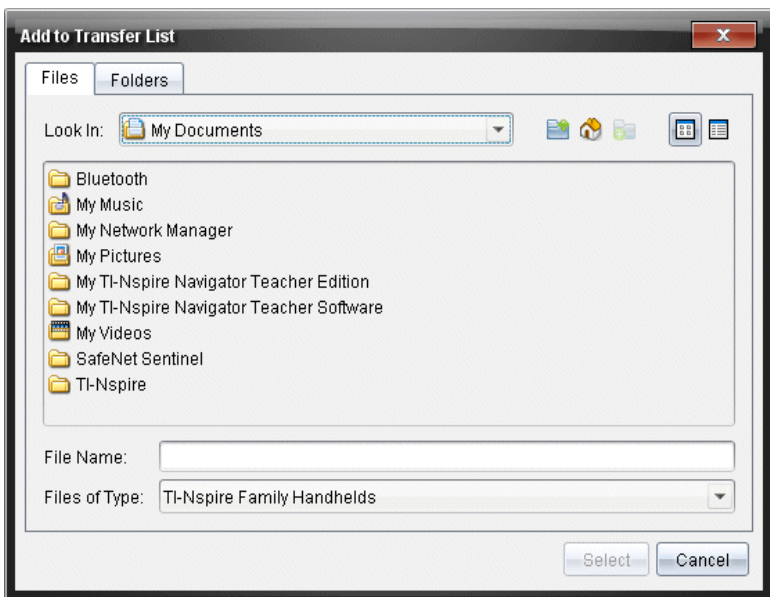

2. To add files to the Transfer List, navigate to the folder or folders that contain the files you want to transfer.

3. Click **Select** to add highlighted files to the Transfer list.
 - On the Files tab, you can see both files and folders, but you cannot select folders. You must drill down and select a file.
 - To select multiple files within a folder, press and hold the **Ctrl** key (Mac®: **⌘**) while selecting files.
4. To add folders containing files, click the Folders tab and navigate to the folder you want to select.
5. Click **Select** to add the highlighted folders.

Note: To select multiple folders, press and hold the **Ctrl** key (Mac®: **⌘**) while selecting folders.

Selected files and folders are displayed in the Transfer Tool dialog box.

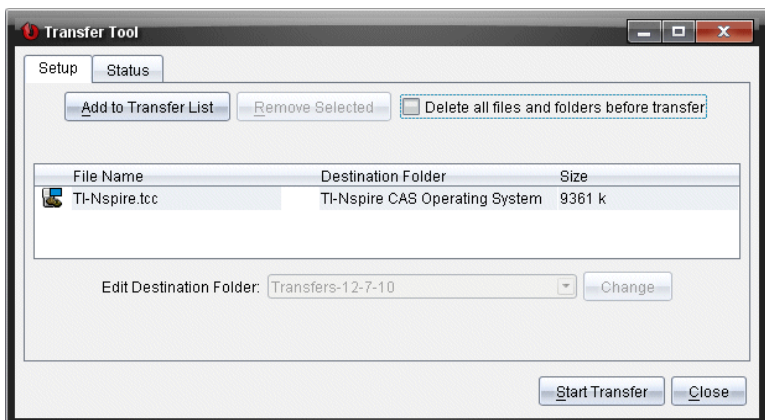

Note: You can only add one operating system file type to the Transfer List. If you attempt to add more than one operating system file type, the following error message is displayed.

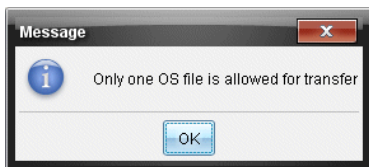

Removing Files or Folders from the Transfer List

You can remove files or folders that you no longer want to transfer.

To remove files or folders from the Transfer List, complete the following steps:

1. In the Transfer Tool dialog box, select files or folders you want to remove.

Note: To select multiple files or folders, press and hold the **Ctrl** key (Mac®: **⌘**) while selecting each file or folder.

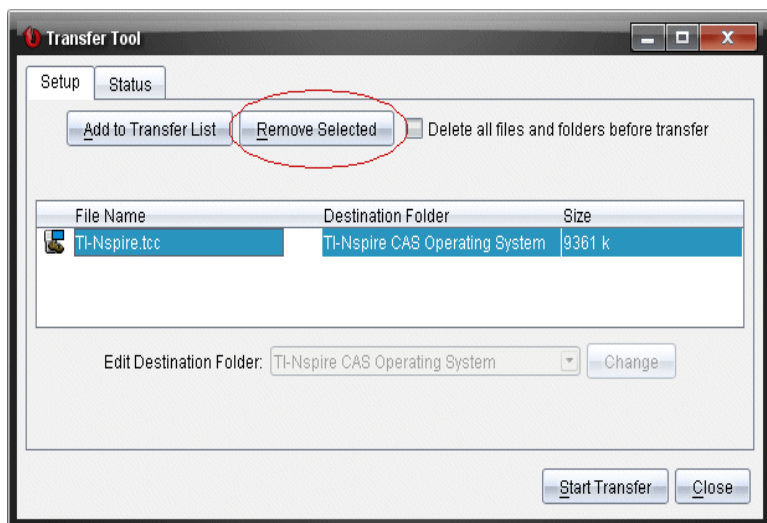

2. Click **Remove Selected**.

The files or folders are removed from the Transfer List.

Editing the Destination Folder

Except for an operating system file, you can change the destination folder for any file or folder in the Transfer List.

By default, the Transfer Tool creates the destination folder “*Transfer-date*.” The date format is based on the user’s preferred language setting and location. For example, the default date format for the United States is *mm-dd-yy*. If you change your preferred language setting, this default date format changes.

To change the destination folder:

1. Click a file or folder.
2. Complete one of the following actions:
 - From the **Edit Destination Folder** drop-down list, select the top level folder for any available handheld or any available folder.

- In the **Edit Destination Folder** drop-down list, type a new destination folder name.

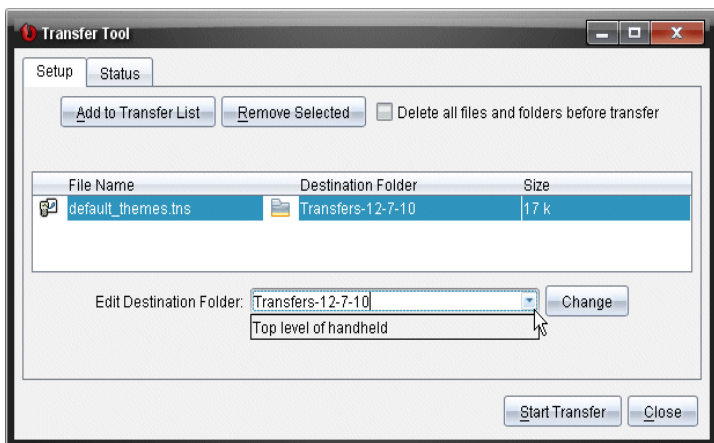

Note: Folder names can contain alphanumeric characters and can include slashes (/ and \). You cannot use double slashes (// and \\) and these special characters (? | : * " < > |).

3. Click **Change**.

The destination folder in the Transfer List changes for the files or folders you selected.

Deleting All Handheld Files and Folders

You can use the Transfer Tool to delete all files and folders on a connected handheld. Use this feature to delete existing files and folders to ensure that only the files you want students to work with are on the handhelds.

By default, the Transfer Tool disables this setting. If selected, the new setting becomes the default the next time you open Transfer Tool.

To delete all files and folders from a connected handheld:

1. In the Transfer Tool dialog box, select **Delete all files and folders before transfer**.

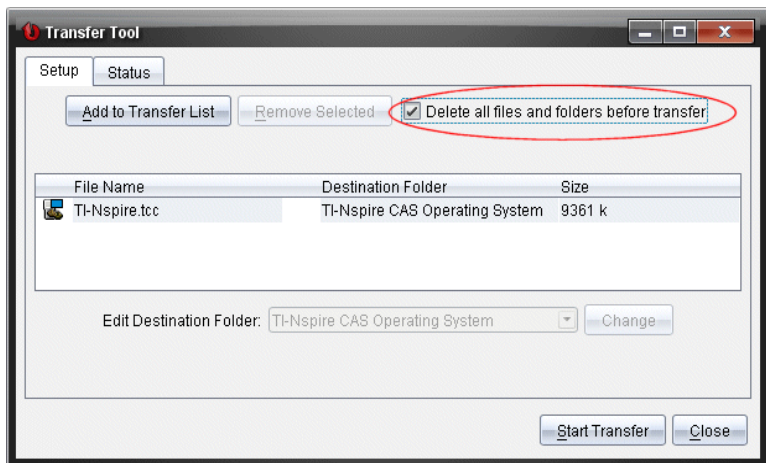

2. Click **Start Transfer**.

The Confirm dialog box opens.

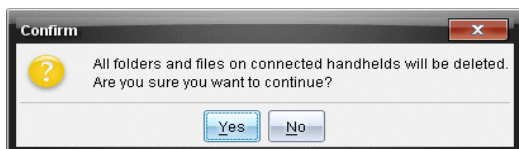

3. Click **Yes**.

The Transfer Tools displays the **Status** tab. This tab displays the status and progress as files are deleted.

Starting a Transfer

After you have added all files and folders to the Transfer List and selected other options as necessary, you can start the transfer. You can transfer operating system files and documents at the same time.

To start a transfer:

1. Connect one or more TI-Nspire™ handhelds.
If handhelds are not connected, the **Status** tab indicates “*No Active Connected Handhelds*” when you start a transfer.
2. From the Resources pane, complete one of the following actions:

- To transfer files to one or more TI-Nspire™ handhelds, select the individual handhelds.
 - To transfer files to all connected TI-Nspire™ handhelds, select Connected Handhelds (top level).
3. In the Transfer Tool dialog box, click **Start Transfer**.
- The Transfer Tool dialog box switches to the Status tab and displays the transfer information.
- The progress bar disappears when a transfer is complete.
 - During a transfer, the Transfer Tool indicates which handhelds are connected and successfully received files.
 - If a handheld disconnects and then reconnects during a transfer, the Transfer Tool indicates the status of completed transfers, and resumes transferring other files as necessary.

Stopping File Transfers

You can stop a file transfer at any time.

To stop a file transfer:

1. In the Transfer Tool, click **Stop Transfer**.

The Confirm dialog box opens.

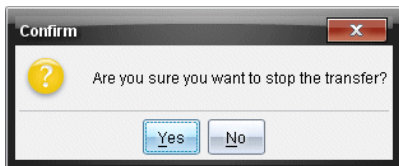

2. Click **Yes**.

The Transfer Tool stops transferring and displays the Setup tab.

- If a connected handheld has already received files, those files remain on the handhelds.
- Files remain in the Setup tab until you close the Transfer Tool, or until you delete them.

Closing the Transfer Tool

When you have completed transferring files and folders, close the Transfer Tool.

- ▶ To close the Transfer Tool, click **Close**.
 - You cannot close the Transfer Tool if a transfer is active.
 - When closed, the Transfer Tool clears files and folders you added to the Transfer List.
 - When closed, the Transfer Tool keeps the last **Delete all files and folders before transfer** setting.

Using the Documents Workspace

Use this workspace to create, modify, and view TI-Nspire™ and PublishView™ documents, and to demonstrate mathematical concepts.

Exploring the Documents Workspace

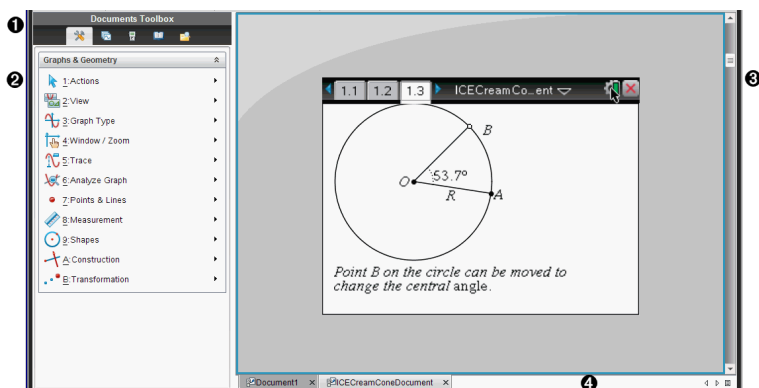

1 Documents Toolbox. Contains tools such as the Document Tools menu, Page Sorter, TI-SmartView™ emulator, Utilities, and Content Explorer. Click each icon to access the available tools. When you are working in a TI-Nspire™ document, the tools available are specific to that document. When you are working in a PublishView™ document, the tools are specific to that document type.

2 Toolbox pane. Options for the selected tool are displayed in this area. For example, click the Document Tools icon to access tools needed to work with the active application.

Note: In the TI-Nspire™ Teacher Software, the tool for configuring questions opens in this space when you insert a question. For more information, see *Using Question in the TI-Nspire™ Teacher Software*.

3 Work area. Shows the current document and enables you to perform calculations, add applications, and add pages and problems. Only one document at a time is active (selected). Multiple documents appear as tabs.

4 Document information. Shows the names of all open documents.

When there too many open documents to list, click the forward and backward arrows to scroll through the open documents.

Using the Documents Toolbox

The Documents Toolbox, located on the left side of the workspace, contains tools needed for working with both TI-Nspire™ documents and PublishView™ documents. When you click a toolbox icon, the associated tools appear in the Toolbox pane.

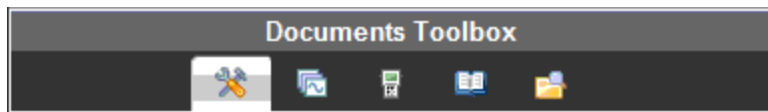



Exploring Document Tools

In the following example, the Document Tools menu is open showing the options for the Calculator application. In TI-Nspire™ documents, the Document Tools menu contains tools available for working with an application. The tools are specific to the active application.

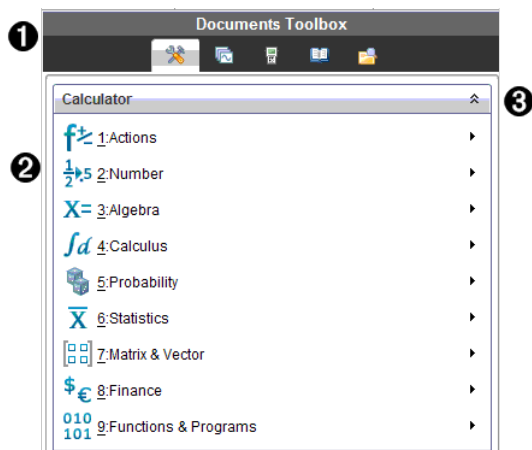
In PublishView™ documents, the Document Tools menu contains tools needed to insert TI-Nspire™ applications and TI-Nspire™ documents, as well as multimedia objects such as text boxes, images, and links to websites and files. For more information, see *Working with PublishView™ Documents*.



- ❶ The Documents Toolbox menu.
- ❷ Tools available for the Calculator application. Click ▶ to open the submenu for each option.
- ❸ Click  to close and click  to open Document Tools.

Exploring the Page Sorter

The following example shows the Documents Toolbox with the Page Sorter open. Use the Page Sorter to:

- See the number of problems in your document and where you are.
- Move from one page to another by clicking on the page you want.
- Add, cut, copy, and paste pages and problems within the same document or between documents.

Note: When you are working in a PublishView™ document, the Page Sorter is not available in the Documents Toolbox.

The screenshot displays the TI-SmartView™ interface. At the top is the 'Documents Toolbox' with various icons. Below it is a document pane showing 'Problem 1' and 'Problem 2'. The main workspace is divided into three sections:

- Section 1:** A spreadsheet with columns 'time' and 'distance'. The data points are: (2, 2), (4, 4), (5, 5), (7, 7), (9, 9). A text box to the right says: 'Data can easily be entered into a spreadsheet with the columns named with the columns named to represent the data.'
- Section 2:** A scatter plot of the data points. Below the plot, it says: 'Add a movable line to the plotted data: menu>Analyze>Add Movable Line Adjust the line to fit the data.'
- Section 3:** A scatter plot of the same data points. Below the plot, it says: 'Find a regression model: menu>Analyze>Regression>Show Linear (m*x+b) Move a point and observe the model.'

Callout 1 points to the Documents Toolbox menu. Callout 2 points to the collapse/expand controls. Callout 3 points to the vertical scroll bar.

- 1 The Documents Toolbox menu.
- 2 Click the minus sign to collapse the view. Click the + sign to open the view and show pages in the document.
- 3 Scroll bar. The scroll bar is only active when there are too many pages to show in the pane.

Exploring the TI-SmartView™ Feature

The TI-SmartView™ feature emulates how a handheld works. In the teacher software, the emulated handheld facilitates classroom presentations. In the student software, the emulated keypad gives students the ability to drive the software as if using a handheld.

Note: Content is displayed on the TI-SmartView™ small screen only when the document is in Handheld view.

When working in a PublishView™ document, TI-SmartView™ emulator is not available.

Note: The following illustration shows the TI-SmartView™ panel in the teacher software. In the Student Software, only the keypad is shown. For more information, see Using the TI-SmartView™ Emulator.



- 1 The Documents Toolbox menu.
- 2 Handheld Selector. Click ▼ to select which handheld to show in the pane:
 - TI-Nspire™ CX or TI-Nspire™ CX CAS
 - TI-Nspire™ Touchpad or TI-Nspire™ CAS with Touchpad

- TI-Nspire™ Clickpad or TI-Nspire™ CAS with Clickpad

Then, select how to show the handheld:

- Normal
- High contrast
- Outline

③ View selector. In the teacher software, click ▼ to select the handheld view:

- Handheld only
- Keypad plus side screen
- Handheld plus side screen

Note: You can also change these options in the TI-SmartView™ Options window. Click **File > Settings > TI-Smartview™ Options** to open the window.

Note: The view selector is not available in the student software.

When the Handheld Only display is active, select **Always in Front** to keep the display in front of all other open applications. (Teacher software only.)

Exploring Utilities

Utilities provides access to the math templates and operators, special symbols, catalog items, and libraries that you need when working with documents. In the following example, the Math templates tab is open.

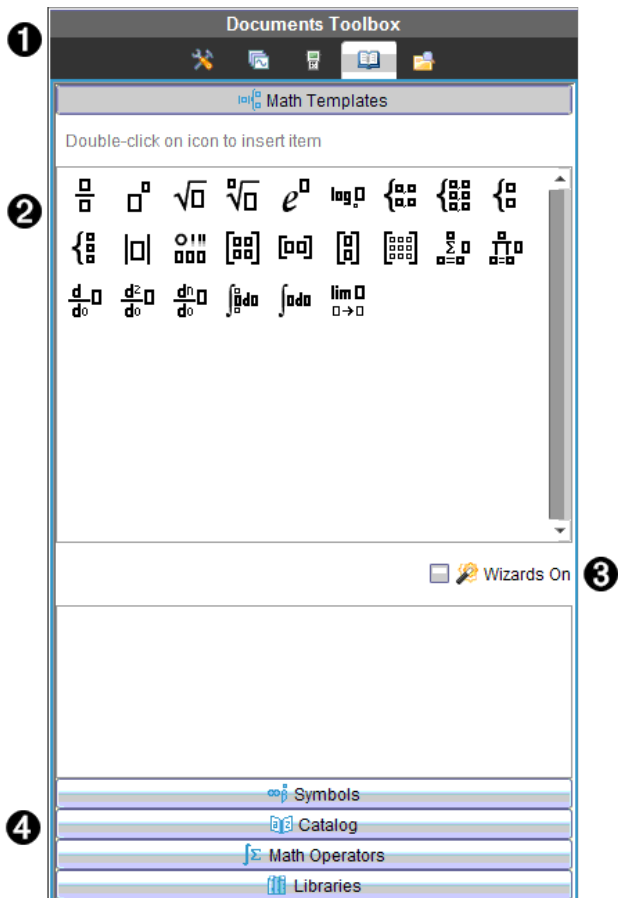

- 1 The Documents Toolbox menu.
- 2 Math Templates are open. Double-click a template to add it to a document. Click the Math Template tab to close the template view. To open the Symbols, Catalog, Math Operators, and Libraries, click the tab.
- 3 Wizards On check box. Select this option to use a wizard to enter function arguments.
- 4 Tabs for opening views where you can select and add symbols, catalog items, math operators, and library items to a document. Click the tab to open the view.

Exploring Content Explorer

Use Content Explorer to:

- See a list of files on your computer.
- Create and manage lesson bundles.
- If using software that supports connected handhelds, you can:
 - See a list of files on any connected handheld.
 - Update the OS on connected handhelds.
 - Transfer files between a computer and connected handhelds.

Note: If you are using TI-Nspire™ software that does not support connected handhelds, the Connected Handheld heading is not shown in the Content Explorer pane.

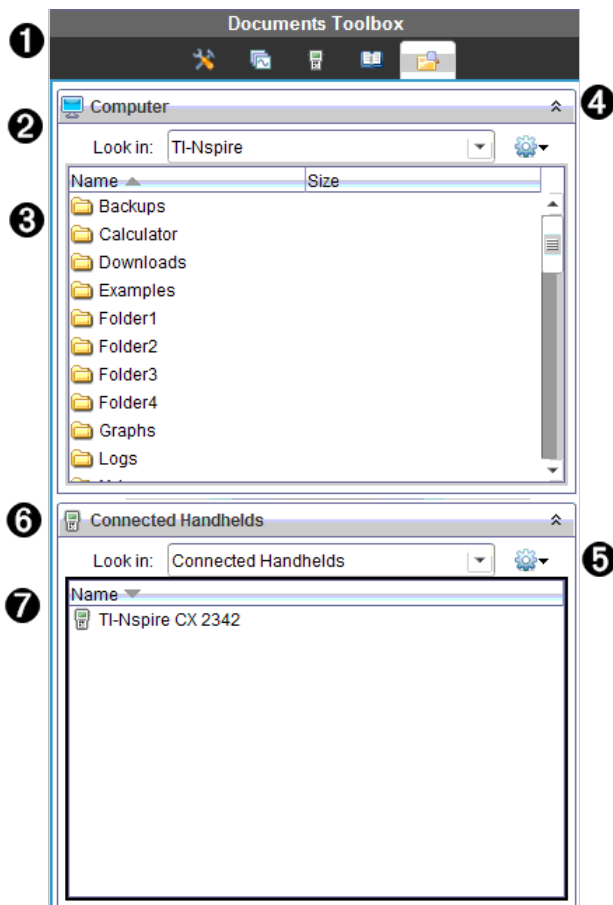

- ❶ The Documents Toolbox menu.
- ❷ Shows files on your computer and the name of the folder where the files are located. Click ▼ to navigate to another folder on the computer.
- ❸ The list of folders and files within the folder named in the **Look In:** field. Right-click on a highlighted file or folder to open the context menu listing available actions for that file or folder.
- ❹ Click ▲ to close the list of files. Click ▼ to open the list of files.
- ❺ Options menu. Click ▼ to open the menu of actions you can perform on a selected file:

- Open an existing file or folder.
 - Move (navigate) up one level in the folder hierarchy.
 - Create a new folder.
 - Create a new lesson bundle.
 - Rename a file or folder.
 - Copy selected file or folder.
 - Paste file or folder copied to Clipboard.
 - Delete selected file or folder.
 - Select all files in a folder.
 - Package lesson bundles.
 - Refresh the view.
 - Install OS.
- ⑥ Connected handhelds. Lists the connected handhelds. Multiple handhelds are listed if more than one handheld is connected to the computer or when using the TI-Nspire™ Docking Stations.
- ⑦ The name of the connected handheld. To show the folders and files on a handheld, double-click the name.
- Click ▼ to navigate to another folder on the handheld.

Using the Work Area

The space on the right side of the workspace provides an area for creating and working with TI-Nspire™ and PublishView™ documents. This work area provides a view of the document so that you can add pages, add applications, and perform all work. Only one document at a time is active.

When you create a document, you specify its page size as Handheld or Computer. This is how the page is displayed in the work area.

- **Handheld** page size is optimized for the smaller screen of a handheld. This page size can be viewed on handhelds, computer screens, and tablets. The content is scaled when viewed on a larger screen.

- **Computer** page size takes advantage of the larger space of a computer screen. These documents can show details with less scrolling required. The content is not scaled when viewed on a handheld.

You can change the page preview to see how the document will look in a different page size.

- ▶ To change the page preview, click **Document Preview** on the toolbar, and then click **Handheld** or **Computer**.

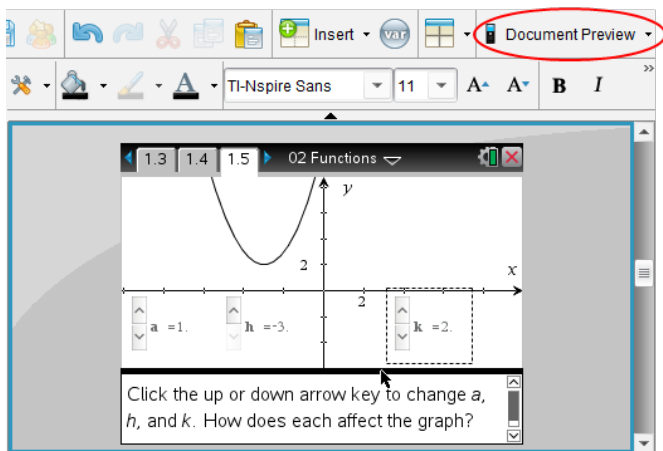

For more information on page size and document preview, see *Working with TI-Nspire™ Documents*.

Changing Document Settings

Document settings control how all numbers, including elements or matrices and lists, are displayed in TI-Nspire™ and PublishView™ documents. You can change the default settings at anytime and you can specify settings for a specific document.

Changing Document Settings

1. Create a new document or open an existing document.
2. From the TI-Nspire™ **File** menu, select **Settings > Document Settings**.

The Document Settings dialog box opens.

When you open Document Settings the first time, the default settings are displayed.

3. Press **Tab** or use your mouse to move through the list of settings. Click ▼ to open the drop-down list to view the available values for each setting.

Field	Value
Display Digits	<ul style="list-style-type: none">• Float• Float1 - Float12• Fix0 - Fix12
Angle	<ul style="list-style-type: none">• Radian• Degree• Gradian
Exponential Format	<ul style="list-style-type: none">• Normal• Scientific• Engineering
Real or Complex Format	<ul style="list-style-type: none">• Real• Rectangular• Polar
Calculation Mode	<ul style="list-style-type: none">• Auto• CAS: Exact• Approximate <p>Note: Auto mode shows an answer that is not a whole number as a fraction except when a decimal is used in the problem. Exact mode (CAS) shows an answer that is not a whole number as a fraction or in symbolic form, except when a decimal is used in the problem.</p>
Vector Format	<ul style="list-style-type: none">• Rectangular• Cylindrical• Spherical
Base	<ul style="list-style-type: none">• Decimal• Hex• Binary
Unit System (CAS)	<ul style="list-style-type: none">• SI• Eng/U.S.

4. Click the desired setting.

5. Choose one of the following options:
 - To apply the customized settings to ALL documents, click **Make Default**.
 - To apply the settings to the open document only, click **OK**.
 - To restore default settings, click **Restore**.
 - Click **Cancel** to close the dialog box without making changes.

Changing Graphs & Geometry Settings

Graphs & Geometry settings control how information is displayed in open problems and in subsequent new problems. When you change the Graphs & Geometry settings, the selections become the default settings for all work in these applications.

Complete the following steps to customize the application settings for graphs and geometry.

1. Create a new graphs and geometry document or open an existing document.
2. In the Documents Toolbox, click  to open the Graphs & Geometry application menu.
3. Click **Settings > Settings**.

The Graphs & Geometry Settings dialog box opens.

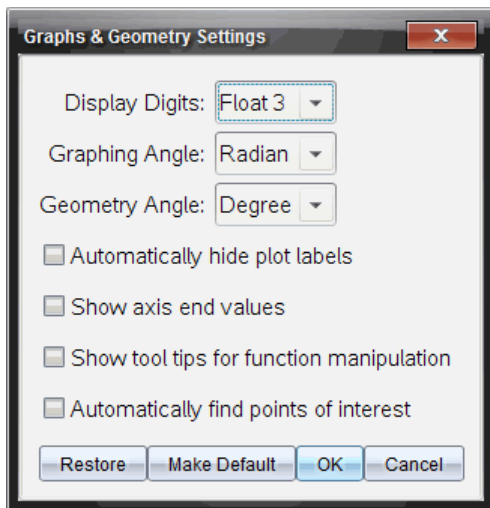

4. Press **Tab** or use your mouse to move through the list of settings. Click **▶** to open the drop-down list to view the available values for each setting.

Field	Values
Display Digits	<ul style="list-style-type: none"> • Auto • Float • Float1 - Float12 • Fix0 - Fix12
Graphing Angle	<ul style="list-style-type: none"> • Auto • Radian • Degree • Gradian
Geometry Angle	<ul style="list-style-type: none"> • Auto • Radian • Degree • Gradian

5. Select the desired setting.

6. Select a check box to enable an option or clear a check box to disable an option.

Check box	Operation when selected
Automatically hide plot labels	Plot labels are displayed only when selected, grabbed, or hovered.
Show axis end values	A numeric label is displayed at the least and greatest values visible on an axis
Show tool tips for function manipulation	Shows helpful information as you manipulate function graphs
Automatically find a point of interest	Shows zeros, minima, and maxima for graphed functions and objects while tracing function graphs.

7. Choose one of the following options:
- To apply the customized settings to ALL graphs and geometry documents, click **Make Default**.
 - To apply the settings to the open document only, click **OK**.
 - To restore default settings, click **Restore**.
 - Click **Cancel** to close the dialog box without making changes.

Working with TI-Nspire™ Documents

All work that you create and save using TI-Nspire™ applications is stored as a document, which you can share with others using TI-Nspire™ software and with those using handhelds. There are two types of documents:

- TI-Nspire™ document (.tns file)
- PublishView™ document (.tnsp file)

TI-Nspire™ Documents

A TI-Nspire™ document consists of one or more problems. Each problem can contain one or more pages. A single page is displayed in the work area. All work occurs in the applications within pages.

Because the TI-Nspire™ software and handhelds share the same functionality, you can transfer TI-Nspire™ documents between computers and handhelds. When you create a document, you select one of two page sizes.

- **Handheld.** Size: 320 × 217 pixels. This size allows documents to be viewed on all platforms. The content will be scaled when viewed on a tablet or larger screen.
- **Computer.** Size: 640 × 434 pixels. The content will not be scaled when viewed on smaller platforms. Some content may not be visible on a handheld device.

You can convert a document from one page size to the other anytime.

PublishView™ Documents

PublishView™ documents can be printed on a standard piece of paper or published to a website or blog. PublishView™ documents can include formatted text, images, and hyperlinks as well as all TI-Nspire™ applications.

For more information, see *Working with PublishView™ Documents*

Creating a New TI-Nspire™ Document

When you open the software, the Documents Workspace opens with a blank document containing one problem. You can add applications and content to this problem to create a document.

Note: The Welcome Screen is displayed when you open the software if the "always show this at startup" option is selected. Click an application icon to add a problem with an active application to a new document.

To create a new document, complete the following steps:

1. On the TI-Nspire™ **File** menu,
 - Select **New TI-Nspire™ Document - Handheld Page Size**.
 - or-
 - Select **New TI-Nspire™ Document - Computer Page Size**.

The new document opens in the Documents Workspace, and you are prompted to select an application.

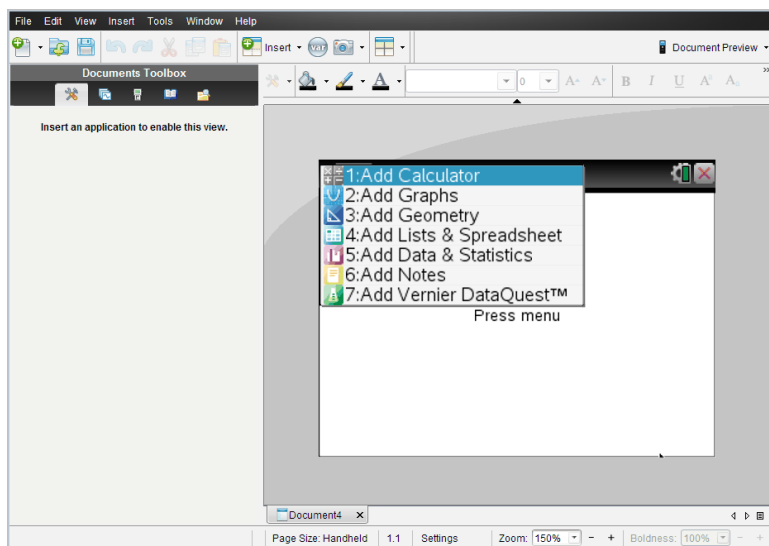

2. Select an application to add a problem to the document.
The problem is added to the document.

Opening an Existing Document

To open an existing document:

1. Click **File > Open Document**.
- or-

Click .

The Open dialog box opens.

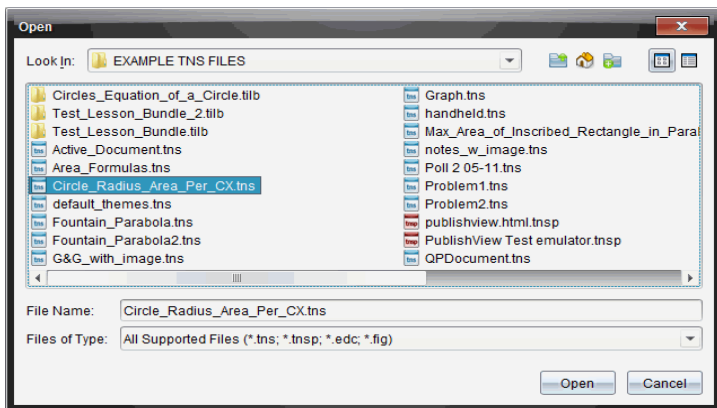

2. Use the file browser to locate the file you want to open and click the file to select it.
3. Click **Open**.

The document opens in the work area.

Note: To select from your 10 most recent documents, click **File > Recent Documents** and select a document from the drop-down list.

Saving TI-Nspire™ Documents

To save a new document:

1. Click **File > Save Document** or click .

The Save TI-Nspire™ Document dialog box opens.

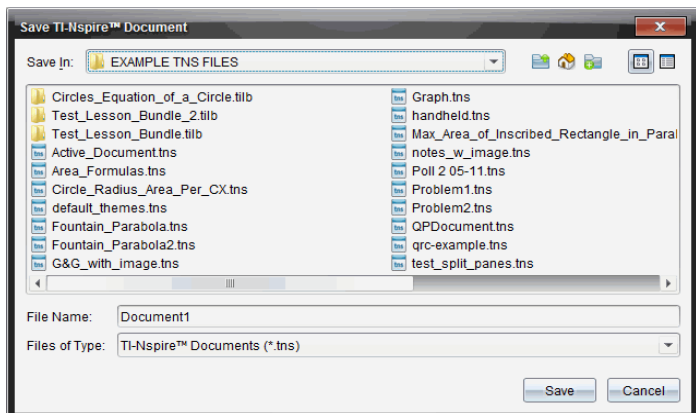

2. Navigate to the folder where you want to save the document or create a folder in which to store the document.
3. Type a name for the new document.
4. Click **Save** to save the document.

The document closes and is saved with the extension `.tns`.

Note: When you save a file, the software looks in the same folder the next time you open a file.

Saving a Document with a New Name

To save a previously saved document in a new folder and/or with a new name:

1. Click **File > Save As**.

The Save TI-Nspire™ Document dialog box opens.

2. Navigate to the folder where you want to save the document or create a folder in which to store the document.
3. Type a new name for the document.
4. Click **Save** to save the document with a new name.

Deleting Documents

File deletions on your computer are sent to the Recycle bin and can be retrieved if the Recycle bin has not been emptied.

Note: File deletions on the handheld are permanent and cannot be undone, so be sure that you want to delete the file that you select.

1. Select the document you want to delete.

2. Click **Edit > Delete** or press **Delete**.

The Warning dialog box opens.

3. Click **Yes** to confirm the delete.

The document is deleted.

Closing Documents

▶ To close a document, click **File > Close** or click the **Close** icon on the document tab at the bottom of the document.

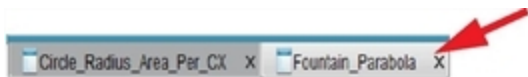



▶ If working in tiled view, click the **Close** icon in the upper right corner of the document window.





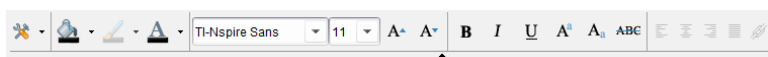



Formatting Text in Documents

Use the text formatting tools to format text in TI-Nspire™ applications that allow text input, and to format text in PublishView™ documents. By default, the text formatting toolbar opens in the area above an active document. Options on the toolbar are enabled or disabled depending on the active application.

For example, the following image shows options available in an active Graphs & Geometry document.



Option	Function
	Click ▼ to open the menu for the active application. This tool enables you to open an application menu regardless of the option selected in the Documents Toolbox.
	Click ▼ to select a background color for highlighting text or choose a fill color for a

Option	Function
	selected cell.
	Click ▼ to select the line color for an object. For example, in Graphs & Geometry, you can choose a color for a selected shape.
	Click ▼ to select a color for selected text.
	<p>Use these tools to choose a font and set the size of the font.</p> <ul style="list-style-type: none"> Click ▼ to select a different font from the drop-down box. To select a specific font size, click ▼ to select a size from the drop-down box. Click  to increase the font size or click  to decrease the font size incrementally.
	Click the appropriate tool to apply bolding, italics, or underlining; apply superscript or subscript; or strike out text.
	<p>In a PublishView™ document, use these tools to position text within the header or footer, or in text box. Clicking  opens the Hyperlink dialog box.</p> <p>For more information, see <i>Working with PublishView™ Documents</i>.</p>

Hiding and Showing the Formatting Toolbar

- ▶ When the formatting toolbar is visible, click ▲ (located under the toolbar) to hide the toolbar.
- ▶ Click ▼ to show the toolbar when the formatting toolbar is hidden.

Using Colors in Documents

In the TI-Nspire™ applications that allow formatting, you can use color in filled areas of an object, or in lines or text, depending on the application you are using and how you have selected the item. If the icon or menu item that you want to use is not available (dimmed) after you have selected an item, color is not an option for the selected item.

Colors appear in documents opened on your computer and on the TI-Nspire™ CX handheld. If a document containing color is opened on a TI-Nspire™ handheld, colors are displayed in shades of gray.

Note: For more information about using color in a TI-Nspire™ application, see the chapter for that application.

Adding Color from a List

To add color to a fill area, line, or text, complete the following steps:

1. Select the item.
2. Click **Edit > Color** or select where you want to add color (fill, line, or text).
3. Select the color from the list.

Adding Color from a Palette

To add color using the palette, complete the following steps:

1. Select the object.
2. Click the appropriate toolbar icon.
3. Select the color from the palette.

Setting Page Size and Document Preview

When you create a document, you specify its page size as Handheld or Computer, depending on how you expect the document to be used. Documents of both page sizes can be opened on either platform, and you can convert the page size anytime.

- **Handheld.** Size: 320 × 217 pixels. This size allows documents to be viewed on all platforms. The content will be scaled when viewed on a tablet or larger screen.

- **Computer.** Size: 640 × 434 pixels. The content will not be scaled when viewed on smaller platforms. Some content may not be visible on a handheld device.

Note: Page size is independent of document preview. That is, you can view documents of either page size using Handheld or Computer preview.

Converting the Current Document's Page Size

- ▶ On the main TI-Nspire™ **File** menu, select **Convert to**, and then select the page size.
The software saves the current document and creates a copy that uses the requested page size.

Viewing the Document in Handheld Preview

1. On the application toolbar, click **Document Preview**, and select **Handheld**.
The preview changes. This does not change the document's underlying page size.
2. (Optional) Click the **Zoom** tool beneath the work area, and select a magnification value for the preview.

Viewing the Document in Computer Preview

1. On the application toolbar, click **Document Preview**, and select **Computer**.
The preview changes. This does not change the document's underlying page size.
2. (Optional) Click the **Boldness** tool beneath the work area, and select a value to increase or decrease the boldness of text and other items.

Setting a Default Preview

By default, when you open a document, it is automatically displayed using the preview that matches its page size. You can override this rule and specify a preview that you prefer.

1. On the main TI-Nspire™ **File** menu, select **Settings > Preview Settings**.
2. Select the preview that you want documents to use when you open them.

Working with Multiple Documents

When multiple documents are open, document names are listed in tabs at the bottom of the work area. Only one document is active at a time, and only the active document is affected by commands from menus or tools.

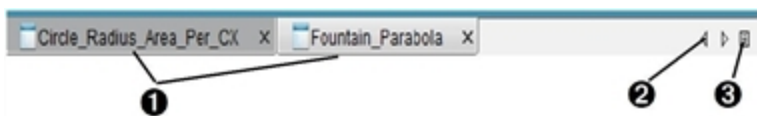

To switch between documents:

- 1 Click the tab to show a document in the work area. This document becomes the active document. If the Show Documents in Tiles view is open, these tabs are not shown.
- 2 Use the right and left arrows to scroll through the list of documents. These arrows are active only when there are too many documents to fit in the window.
- 3 Click the Show List icon to list all open documents. This is useful when you have a large number of documents open and documents names on the tabs may be truncated.

Working with Multiple Documents in Tiled View

When multiple documents are open, you can view thumbnails of the documents in the work area. To change the view:

- ▶ Click **Window > Show Documents in Tiles**.

Open documents are shown as thumbnails in the work area, and the scroll bar becomes active.

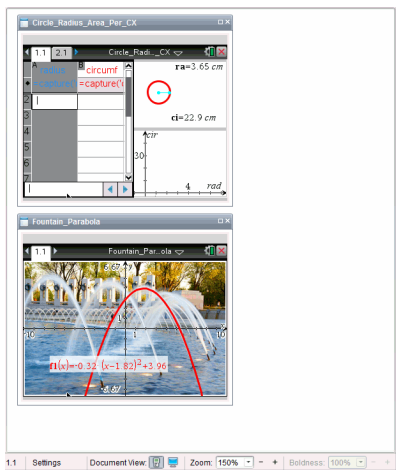

The status bar remains available; however, document names now appear in the thumbnail view. Click **Select Window > Show Documents in Tabs** to view one document at a time in the work area.

Working with Applications

When you first open a new document or add a new problem to a document, select an application from the menu.

The following illustration shows how a problem with the Lists & Spreadsheet application appears in the work area on the right side of the window.

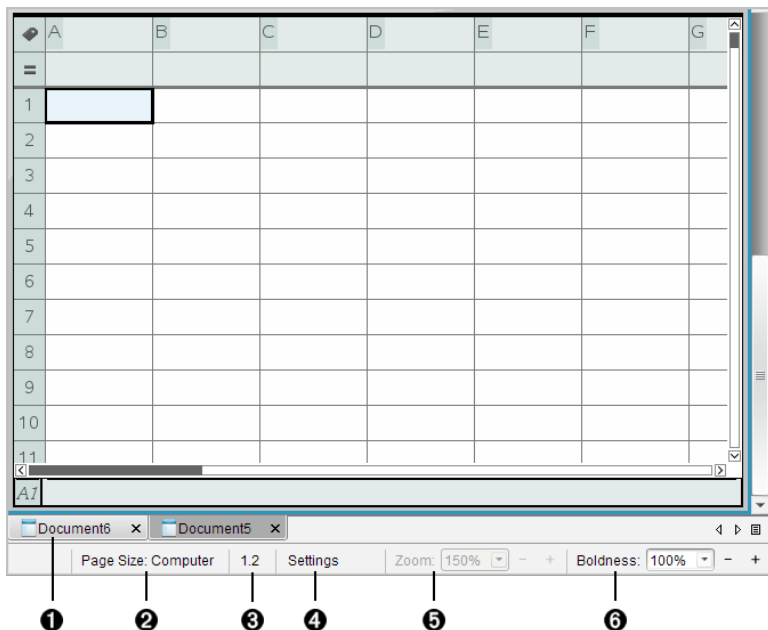

- ❶ **Document name.** Tabs show the names of open documents. Click a name to make it the active document.
- ❷ **Page Size.** Shows the document's page size as Handheld or Computer. You can use the TI-Nspire™ **File** menu to convert a document from one page size to the other.
- ❸ **Problem/Page counter.** The first value represents the problem number of the active page, and the second value tells you the page number within the problem. In the example, the counter reads 1.2, indicating Problem 1, Page 2.
- ❹ **Settings.** Double-click to view or change the Document Settings for the active document or to change the default Document Settings.
- ❺ **Zoom.** Enabled in Handheld preview only (click **Document Preview** on the toolbar and select **Handheld**). Click ▼ and select a magnification value for the preview.
- ❻ **Boldness.** Enabled in Computer preview only (click **Document**

Preview on the toolbar and select **Computer**). Click ▼ and select a value to increase or decrease the boldness of text and other items.

Working with Multiple Applications on a Page

You can add up to four applications to a page. When you have multiple applications on a page, the menu for the active application is displayed in the Documents Toolbox. Using multiple applications involves two steps:

- Changing the page layout to accommodate multiple applications.
- Adding the applications.

You can add multiple applications to a page even if an application is already active.

Adding Multiple Applications to a Page

By default, each page contains space to add one application. To add additional applications to the page, complete the following steps.

1. Click **Edit > Page Layout > Select Layout**.

—or—

Click .

The page layout menu opens.



There are eight page layout options available. If an option is already selected, it is dimmed.

2. Highlight the layout you want to add to the problem or page, and then click to select it.

The new layout is displayed with the first application active.

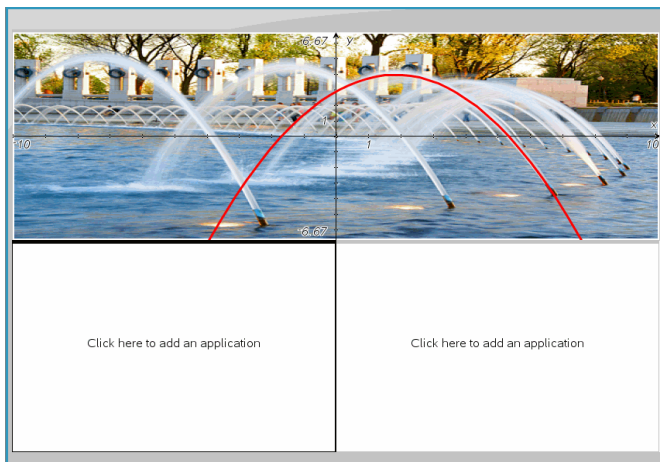

3. In Handheld preview, click **Press menu** to select an application for each new section in the problem or page. In Computer view, select **Click here to add an application**.

Swapping Applications

To change the position of applications on a page with multiple applications, “swap” the positions of two applications.

1. Click **Edit > Page Layout > Swap Application**.

Note: The last active application you worked on is automatically selected as the first application to be swapped.

2. Click the second application to swap.

This action performs the swap.

Note: When there are only two work areas, the selected application automatically swaps position with the other application in the work area.

To cancel a swap, press **Esc**.

Selecting and Moving Pages

To quickly move and rearrange pages in a document that contains multiple pages, use the Page Sorter to list thumbnail views of all pages in the document.

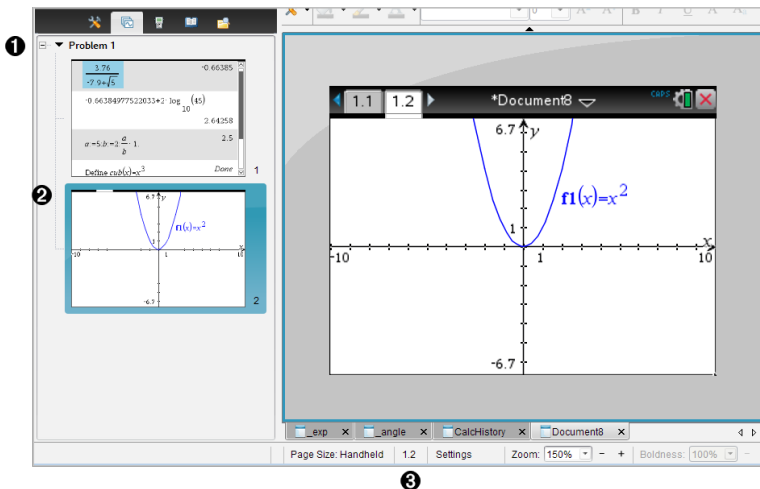

- 1 **Page Sorter.** Show by clicking the Page Sorter button () on the Documents Toolbox. Displays thumbnail sketches of all pages in all problems in the current document. Use the scroll bar to view pages off the screen.
- 2 **Active page.** The page currently highlighted in the Page Sorter and active in the work area.
- 3 **Problem/Page counter.** Displays the problem number followed by the page number.

Selecting Pages

The Page Sorter always indicates the active page in the work area.

- If you are working on a page in the work area, this page is indicated in the Page Sorter by a color border.
- If you are actively using the Page Sorter, the active page displayed in the work area has a color border in the Page Sorter pane.
- Clicking on any page in the Page Sorter makes it the active page, and it is displayed in the work area.

Rearranging Pages

Use the Page Sorter to change the order of pages within a problem.

1. Click to select the thumbnail view of the page in the Page Sorter.

2. Drag the page to the desired position, and release to drop it in the new location.

Grouping Applications

To group up to four pages into a single page:

1. Click the first page in the series.
2. Click **Edit > Page Layout > Group**.

The next page is grouped with the first page. The page layout automatically adjusts to display all the pages in the group.

To ungroup pages:

1. Click the grouped page.
2. Click **Edit > Page Layout > Ungroup**.

The material becomes individual pages and applications.

Deleting an Application from a Page

1. Click the application you want to delete.
2. Click **Edit > Page Layout > Delete Application**.

The application is deleted.

To undo the delete, press **Ctrl + Z** (Mac®: **⌘ + Z**).

Deleting Pages

1. Select the page you want to delete.
2. Click **Edit > Delete**.

–or–

Click .

–or–

Right-click and click **Delete**.

Working with Problems and Pages

When you create a new document, a problem is added with one page. When a document has a problem with multiple pages or multiple problems, click  to open the page sorter view in the Documents Toolbox to view the problems and

pages.

Adding a Problem to a Document

A document can contain up to 30 problems.

1. Click **Insert > Problem**.

–or–

Click .

2. Click **Problem**.

A new problem with one new page is added to your document.

Adding a Page to a Problem

Each problem can contain up to 50 pages.

1. Click **Insert > Page**.

–or–

Click .

2. Click **Page**.

A new page is added to the problem.

3. Select an application to add to the page.

Copying and Pasting a Problem

You can copy and paste a single problem from one location to another within the same document or a different document.

1. Click  to open the Page Sorter.
2. Click a problem name to select it.
3. Click **Edit > Copy** or press **Ctrl + C** (Mac®: **⌘ + C**).
4. Go to the location where you want the problem to appear.
5. Click **Edit > Paste** or press **Ctrl + V** (Mac®: **⌘ + V**).

The problem is copied to the new location.

Deleting a Problem

To delete a problem from the document:

1. Click a problem name to select it.
2. Click **Edit > Delete** or press **Ctrl+X** (Mac®: **⌘ + X**).

The problem is deleted from the document.

Renaming a Problem

To rename a problem:

1. Using the Page Sorter, select the problem name.
2. Right-click and click **Rename**.

The problem name box clears.

3. Type the new name and press **Enter**.

The new name appears in bold to indicate that it has been changed.

Printing Documents

1. Click **File > Print**.

The Print dialog box opens.

2. Set options for the print job.

- Printer – Select from your list of available printers
- Print What:
 - Print All – prints each page on a separate sheet
 - Viewable Screen – prints selected pages with additional layout options (see Layout, below)
- Print Range – Click All Pages, or click Page range and set the starting and ending pages.
- Layout:
 - Orientation (portrait or landscape)
 - The number of TI-Nspire™ pages (1, 2, 4, or 8) to be printed on each sheet (available in Viewable Screen option only). The default is 2 pages per sheet.
 - Whether to allow space below each printed TI-Nspire™ page for comments (available in Viewable Screen option only)
 - Margins (from .25 inches to 2 inches). The default margin is .5 inches on all edges.

- Documentation information to include:
 - Problem name, including the option to group the pages physically by problem
 - Page label (such as 1.1 or 1.2) under each page
 - Page header (up to two lines)
 - Document name in the footer
3. Click **Print**, or click **Save As PDF**.

Note: To restore the Print defaults, click **Reset**.

Using Print Preview

- Click the **Preview** check box to toggle the preview pane.
- Click the arrows at the bottom of the preview pane to page through the preview.

Viewing Document Properties and Copyright Information

Note: Most of these instructions apply only to the Teacher Software.

Checking Page Size

1. In the Teacher Software, go to the TI-Nspire™ **File** menu and select **Document Properties**.
2. Click the **Page Size** tab.
3. A checkmark indicates the document's current page size.

Viewing Copyright Information

The Teacher Software and Student Software let you view copyright information that has been added to a document.

1. On the TI-Nspire™ **File** menu, select **View Copyright Information**.
The Copyright Information dialog box opens.

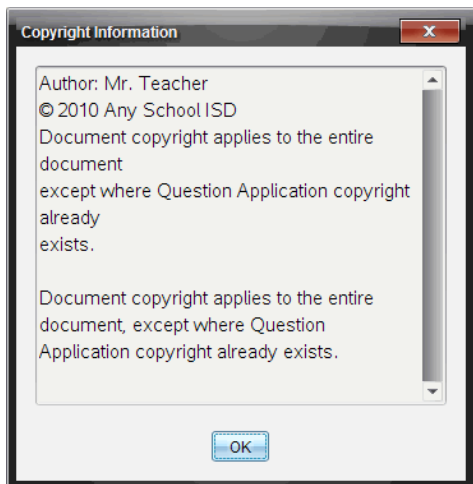

2. Click **OK** to close the dialog box.

Adding Copyright Information to a Document

Using the Teacher Software, you can add copyright information to individual documents that you create, or you can apply the same copyright information to all new documents.

1. Open the document.
2. On the TI-Nspire™ **File** menu, select **Document Properties**.
3. Click the **Copyright** tab.
4. Edit the following fields to define the copyright details:
 - Author
 - Copyright (select Public Domain or Copyright).
 - Year (disabled if you selected Public Domain)
 - Owner (disabled if you selected Public Domain)
 - Comments
5. To add the supplied information to all new documents from this point forward, select **Apply this copyright to all new documents**.
6. Click **OK** to apply the copyright information to the document.

Protecting a Document (making a document read-only)

Teachers can protect documents to create a document for distribution to your students or for other use. A student who receives a read-only document and makes changes to it will be prompted to save the document as a new file.

1. Open the document.
2. On the TI-Nspire™ **File** menu, select **Document Properties**.
3. Click the **Protection** tab.
4. Select the **Make this document Read Only** check box.
5. Click **OK**.

Working with PublishView™ Documents

Use the PublishView™ feature to create and share interactive documents with teachers and students. You can create documents that include formatted text, TI-Nspire™ applications, images, hyperlinks, links to videos, and embedded videos in a format that is suitable for printing on a standard piece of paper, publishing to a website or blog, or for use as an interactive worksheet.

PublishView™ features provide layout and editing features for presenting math and science concepts in a document where TI-Nspire™ applications can be interactively and dynamically linked with supporting media, enabling you to bring the document to life. Using the PublishView™ feature:

- Teachers can create interactive activities and assessments used on screen.
- Teachers can create printed materials to complement documents used on TI-Nspire™ handhelds.
- When working with lesson plans, teachers can:
 - Create lesson plans from existing handheld documents or convert lesson plans to handheld documents.
 - Link to related lesson plans or documents.
 - Embed explanatory text, images, video, and links to web resources.
 - Build or interact with TI-Nspire™ applications directly from the lesson plan.
- Students can create reports or projects such as lab reports containing data playback, curve fits, pictures, and video—all on the same sheet.
- Students can print and turn in assignments on a standard piece of paper.
- Students taking exams can use one tool to create a document that contains: all problems on the exam, text, images, hyperlinks, or videos, interactive TI-Nspire™ applications, screen shots, and layout options needed to print a document.

Note: PublishView™ documents can be exchanged using the TI-Nspire™ Navigator™ NC system. PublishView™ documents can reside in the Portfolio Workspace, and TI-Nspire™ questions within a PublishView™ document can be automatically graded by the TI-Nspire™ Navigator™ system.

Creating a New PublishView™ Document

1. From the Documents Workspace, click **File > New PublishView™ Document**.

–or–

Click , and then click **New PublishView™ Document**.

- A blank letter-size document opens in the Documents Workspace. The orientation is portrait, which cannot be changed.
 - The default margin settings for the top and bottom margins are one-inch. There are no settings for side margins.
 - By default, a problem is added to the document.
 - By default, the document contains the page number in a # of # format at the bottom of the sheet.
 - The scroll bars on the right side of the screen and at the bottom of the screen are active.
2. Add TI-Nspire™ applications and PublishView™ objects as needed to complete the document.

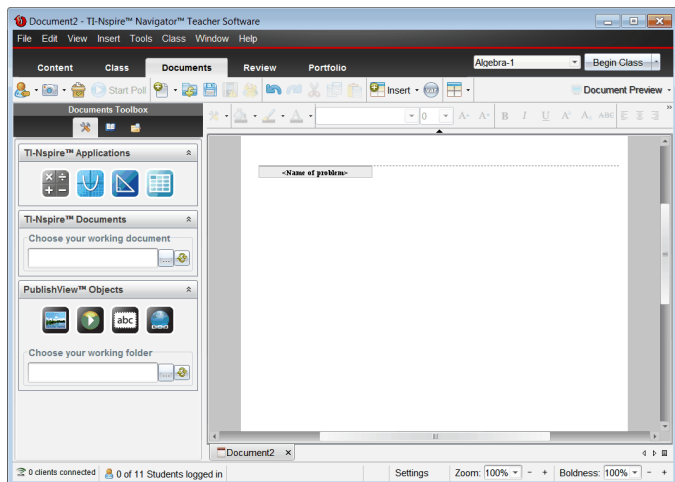

About PublishView™ Documents

When working with PublishView™ documents, it is important to keep the following points in mind:

- PublishView™ documents are saved as .tnsp files, which distinguishes them from TI-Nspire™ documents (.tns files).
- When inserting PublishView™ objects into a document, the text, image, hyperlink, or embedded video are contained in boxes that can be moved and resized.
- When you insert TI-Nspire™ applications, they work the same way as pages in a TI-Nspire™ document.
- In a PublishView™ document, objects can overlap each other and you can control which object is on top or bottom.
- Objects can be placed and positioned in a PublishView™ document in a free-form fashion.
- You can convert an existing TI-Nspire™ document to a PublishView™ document (.tnsp file).
- When you convert a PublishView™ document to a TI-Nspire™ document (.tns file), TI-Nspire™ applications are converted. PublishView™ objects containing text, hyperlinks, videos, and images are not converted.
- You cannot create or open a PublishView™ document on a handheld. You must convert a PublishView™ document to a TI-Nspire™ document before sending it to a handheld.

Exploring a PublishView™ Document

The following example shows how you might use TI-Nspire™ applications and PublishView™ objects to build a PublishView™ document. In this example, borders are turned on to show the boundaries around the objects. Showing borders enables you to work with objects easily while building a document. When you are ready to print or publish the document to the web, you can select to the hide borders.

If a Tree Falls... ①

Problem 1

②

You have all heard the joke, "If a tree falls in a forest, will anyone hear it?" In this lesson, we explore the algebra to a falling tree and answer the question, "If a tree falls in your neighborhood, will it land on your car or house?"

1. Explore

Below, explore what happens if a 16 meter pole breaks by grabbing any of the two open circles. How far away from the base of the pole will the pole hit?

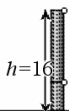

2. Solve it

Can you write a formula for the distance (d) in terms of height (h)?

$$f1(x):=\sqrt{256-32\cdot x}$$

$$h^2+d^2=(16-h)^2$$

$$h^2+d^2=256-32h+h^2$$

3. Graph It

Graph your formula as a function.

Think: Do all values of the function apply to the situation above? Modify the function f to bound the range so that it makes sense.

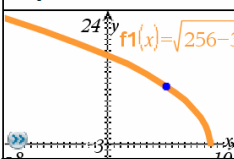

4. Application

When cutting down a tree, it might be good to figure out where the top of the tree will land!



© Texas Instruments, Inc. 2010

1 of 1

- Header.** In this example, the header contains the title of the document. When the header area is active, you can type and format text as needed.
- Problem break and name.** In PublishView™ documents, use problem breaks to control the page layout. You can select to hide or show problem breaks. Deleting a problem removes the contents of the problem and removes the space between problems when there are multiple problems. Problem breaks also enable you to use variables in PublishView™ documents. Variables that have the same name are independent of one another if they are used in different problems.
- Text boxes.** In this example, the introduction text and the text in boxes 1, 2, 3, and 4 is contained in text boxes. You can insert text and hyperlinks into a PublishView™ document using a text box. Text boxes can be resized and positioned as needed. PublishView™ text boxes are not retained when you convert a PublishView™ document to a TI-Nspire™ document.
- TI-Nspire™ applications.** In this example, the author uses Graphs & Geometry to show the math functions. When a TI-Nspire™ application is active in a PublishView™ document, the appropriate application menu

opens in the Documents Toolbox. You can work in a TI-Nspire™ application just as you would in a TI-Nspire™ document. When you convert a PublishView™ document to a TI-Nspire™ document, applications are retained.

- 5 **Notes application.** You can also use the TI-Nspire™ Notes application to add text to a PublishView™ document. Because Notes is a TI-Nspire™ application, it will be retained when you convert the PublishView™ document to a TI-Nspire™ document. Using the Notes application enables you to use an equation editor and can contain TI-Nspire™ math templates and symbols.
- 6 **Video.** This is an example of a video that is embedded in a PublishView™ document within a frame. Users can start and stop the video using the controls. Frames containing videos and images can be resized and positioned in the document as needed.
- 7 **Footer.** By default, the footer area contains the page number, which cannot be edited. You can add other text above the page number if needed. Like the header, you can format text as needed.

Using the Status Bar in a PublishView™ Document

When a PublishView™ document is open, options on the status bar are different than when working in a TI-Nspire™ document.

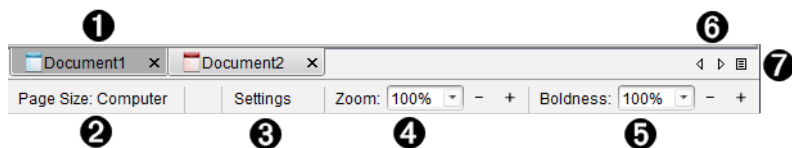



- 1 Document names are displayed in tabs. If multiple documents are open, the document names are listed. You can have TI-Nspire™ and PublishView™ documents open at the same time. In this example, Document 1 is an inactive TI-Nspire™ document (). Document 2 is the active PublishView™ document (). Click the X to close a document.
- 2 **Page Size.** Shows the document's page size as Handheld or Computer. You can use the TI-Nspire™ **File** menu to convert a document from one page size to the other.
- 3 Click **Settings** to change Document Settings. You can specify settings that

are specific to an active document or set default settings for all PublishView™ documents. When you convert a TI-Nspire™ document into a PublishView™ document, the settings in the TI-Nspire™ document convert to the settings defined for PublishView™ documents.

- 4 Use the **Zoom** scale to zoom the active document in or out from 10% to 500%. To set a zoom, type a specific number, use the + and - buttons to increase or decrease by increments of 10%, or use the drop-down box to choose preset percentages.
- 5 In TI-Nspire™ applications, use the **Boldness** scale to increase or decrease the boldness of text and line thickness within applications. To set the boldness, type a specific number, use the + and - buttons to increase or decrease by increments of 10%, or use the drop-down box to choose preset percentages.

For PublishView™ objects, boldness is used to match text within TI-Nspire™ applications to other text on the PublishView™ sheet. It can also be used to increase the visibility of TI-Nspire™ applications when presenting a document to a class.

- 6 When there are too many open document names to show in the status bar, click the forward and backward arrows ( ) to move through the documents.
- 7 Click  to see a list of all open documents.

Saving PublishView™ Documents

Saving a New Document

1. Click **File > Save Document**.

–or–

Click .

The Save TI-Nspire™ Document dialog box opens.

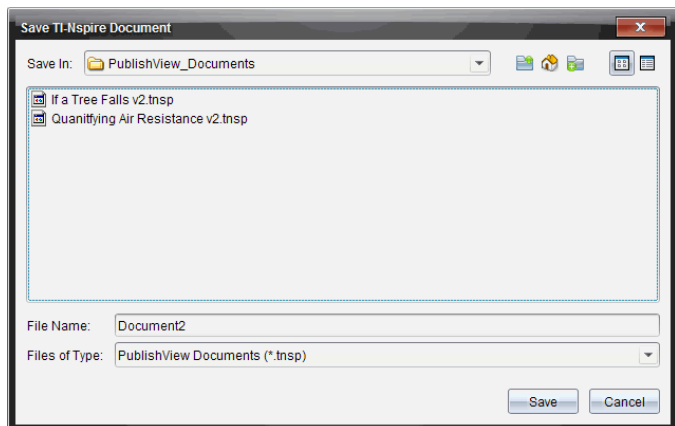

2. Navigate to the folder in which you want to save the document.

–or–

Create a folder in which to store the document.

3. Type a name for the new document.
4. Click **Save**.

The document closes and is saved with the extension .tnsp.

Note: When you save a file, the software first looks in the same folder the next time you open a file.

Saving a Document with a New Name

To save a previously saved document in a new folder and/or with a new name:

1. Click **File > Save As** from the menu.
The Save TI-Nspire™ Document dialog box opens.
2. Navigate to the folder in which you want to save the document.
–or–
Create a folder in which to store the document.
3. Type a new name for the document.
4. Click **Save** to save the document with a new name.

Note: You can also use the **Save As** option to convert documents from TI-Nspire™ files to PublishView™ files or convert PublishView™ files to TI-Nspire™ files.

Exploring the Documents Workspace

When you create or open a PublishView™ document, it opens in the Documents Workspace. Use the menu options and the toolbar just as you would when working with a TI-Nspire™ document to:

- Navigate to existing folders and documents using Content Explorer
- Open existing documents
- Save documents
- Use the copy, paste, undo, and redo options
- Delete documents
- Access TI-Nspire™ application-specific menus
- Open the Variables menu in TI-Nspire™ applications that allow variables
- Access and insert math templates, symbols, catalog items, and library items into a PublishView™ document

Note: For more information, see *Using the Documents Workspace*.



Exploring the Documents Toolbox

When a PublishView™ document is active, the Documents Toolbox contains tools needed for working with PublishView™ documents. You can add TI-Nspire™ applications to a problem, insert parts of existing TI-Nspire™ documents into a problem, and add PublishView™ objects.

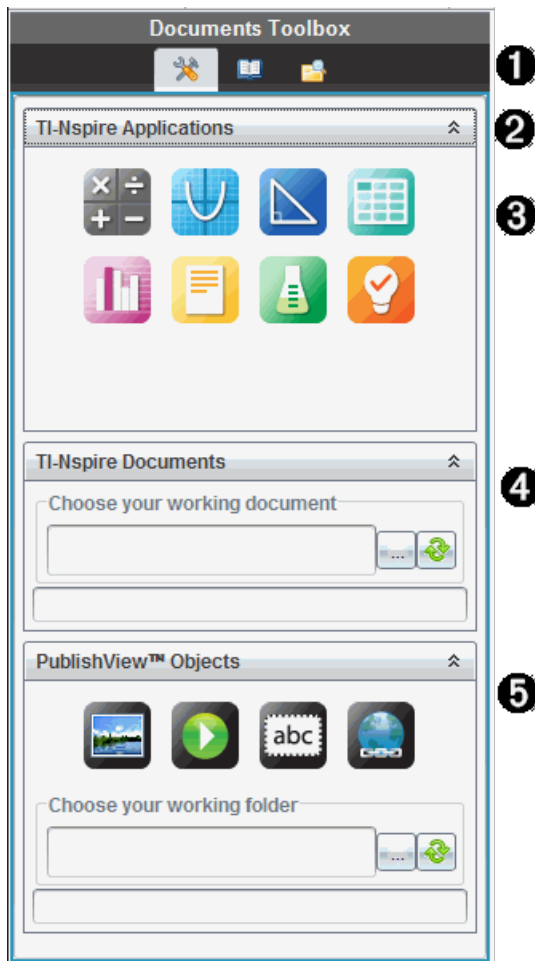

The Documents Toolbox opens when you create a new PublishView™ document or open an existing PublishView™ document. When working in a PublishView™ document, Page Sorter and TI-SmartView™ emulator are not available.



1 In a PublishView™ document:

- Click  to open the application menu and tools needed to work with TI-Nspire™ applications and PublishView™ objects.
- Click  to open the Utilities panel where you can access Math Templates, Symbols, the Catalog, Math Operators, and Libraries.
- Click  to open Content Explorer.

Note: For more information, see *Using the Documents Workspace*.

2 Click  to collapse a pane containing a menu. Click  to expand a pane.

3 TI-Nspire™ applications. Move an icon to a problem to insert an application:



Calculator



Graph



Geometry



Lists & Spreadsheet



Data & Statistics



Notes



Vernier DataQuest™



Question (Available in TI-Nspire™ Teacher Software, TI-Nspire™ Navigator™ Teacher Software, and TI-Nspire™ Navigator™ NC Teacher Software).

4 **TI-Nspire™ Documents.** Use this tool to locate and insert existing TI-Nspire™ documents (.tns files) into a problem.

5 **PublishView™ Objects.** Use this tool to move the following objects into a problem:



Image



Video



Text box



Hyperlink

Using Menus and the Toolbar

When working in a PublishView™ document, select options from the menus or the toolbar in the Documents Workspace to work with content and objects. When you insert an object into a PublishView™ document, you can manipulate it using the same tools as you would when working with a TI-Nspire™ document. In PublishView™ documents, you can:

- Right-click on an object to open a context menu, which displays the actions that can be performed on that object.
- Use add, insert, and paste to add objects to a PublishView™ document.
- Use delete and cut to remove objects from a PublishView™ document.
- Move objects from one place to another within a PublishView™ document.
- Copy objects from one document and paste them into another PublishView™ document.
- Resize and scale objects such as text boxes and images.
- Change the font face and size and apply formatting such as italics, bold, underline, and color to text.

Note: For more information, see *Using the Documents Workspace*.

Using Context Menus

In TI-Nspire™ applications and in PublishView™ documents, context menus provide a list of options specific to the task you are working on. For example, when you right-click a cell while working in the TI-Nspire™ Lists & Spreadsheet application, a context menu opens providing a list of actions that you can perform on that cell. When you right-click the border of a text box in a PublishView™ document, the context menu provides actions that can be performed on the text box.

Context Menus in TI-Nspire™ Applications

When you insert a TI-Nspire™ application into a PublishView™ document, the application menu and the context menus associated with that application are available and work the same way they work in a TI-Nspire™ document.

Context Menus in PublishView™ Documents

In PublishView™ documents, context menus provide shortcuts to frequently

performed tasks. Context menus are specific to an object or area:

- The Sheet context menu provides options for working with the layout of the sheet and document.
- Object context menus provide options for manipulating the object.
- Content-sensitive context menus provide options for working with the content inside the object such as text or a video.

Working with PublishView™ Objects

In a PublishView™ document, text, hyperlinks, images, and videos are contained in PublishView™ objects. You can move, resize, copy and paste, and delete an object within a PublishView™ document. Objects can also be positioned so that one overlaps the other.

Within a document, PublishView™ objects can exist in three states: unselected, selected, and interactive.

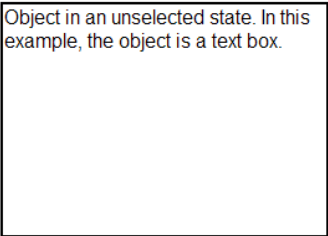
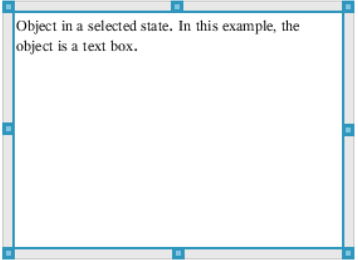
State	Description
Unselected	<p>When unselected, an object does not have handles for repositioning and sizing. To deselect an object, left-click or right-click outside the object.</p> <p>In this example, borders around the object are showing.</p> 
Selected	<p>When selected, an object will have eight square handles framing the object. To select an object, click the object's border. When selected, objects can be moved and resized.</p> 

State	Description	
	<ul style="list-style-type: none"> • To move an object, click a border and drag the object to its new location. • To resize an object, grab a handle. • Right-click the border to open a context menu with options for manipulating the object. 	
Interactive	<p>An interactive state is indicated by a blue frame around the object. To enter interactive state, left-click or right-click anywhere in the body of the object. When in an interactive state, you can work with the contents of the object. For example, you can add or edit text in a text box or complete math functions in a TI-Nspire™ application. When in an interactive state, context menus contain options specific to the contents of an object.</p>	

A	B	C	D
		$\text{seq}(i,1,0)$	
1	u0	1	0
2			1
3	n_max	30	2
4			3
5			4
6			5
7			6

AI u0

Inserting an Object

1. In the Documents Toolbox, ensure the PublishView™ Objects menu is open.

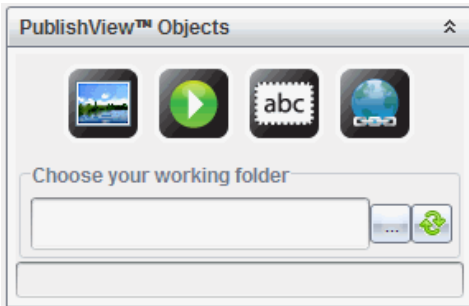

2. Use your mouse to click an icon and drag it to the document.
3. Release the mouse button to drop the object into the document.

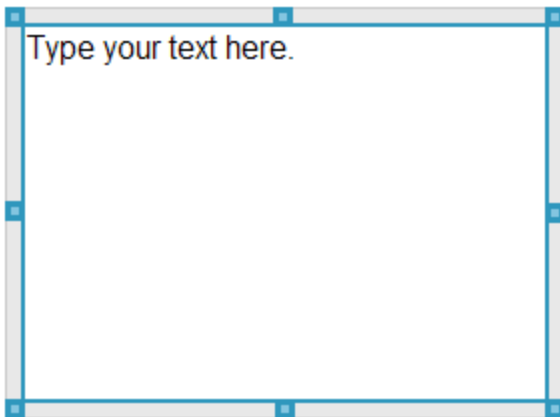

Selected text boxes and frames can be resized, moved, copied, pasted, and deleted.



- Using the mouse, grab the handles to resize the object and drag it to position the object in the document as needed.

Opening Object Context Menus

- Right-click the border of any object in a PublishView™ document. The context menu opens to provide access to delete, copy/paste, cut, and bring to front/send to back actions.

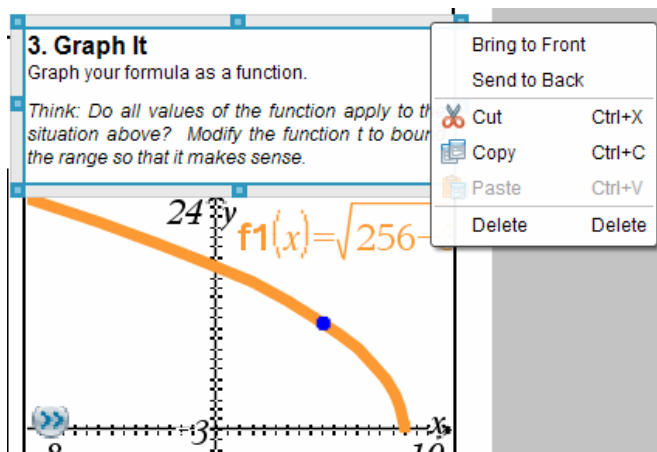

Resizing an Object

1. Click any border around the object to select it. The border becomes a bold blue line and the handles are active.
2. Move your mouse over one of the handles to activate the resizing tool.



3. Grab one of the handles and drag in the direction needed to make the object larger or smaller.
4. Click outside the object to save the new size.

Moving an Object

To move an object to another location on the page:

1. Click any border around the object to select it. The border becomes a bold blue line and the handles are active.
2. Move your cursor over one of the borders to activate the positioning tool



3. Click to grab the object. The horizontal and vertical alignment guides are activated at the top and bottom of the object. Use the grid lines to position the object on the page.

1 vertical alignment guide

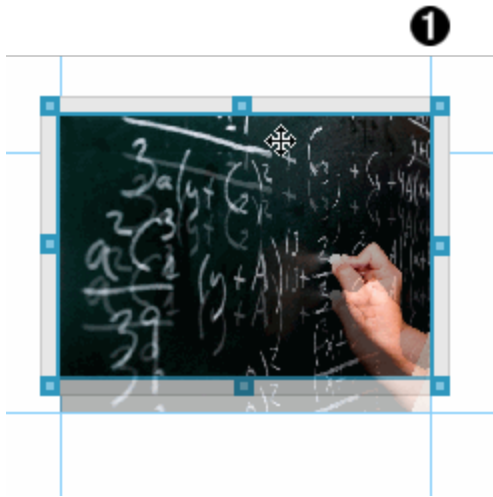

2

2 horizontal alignment guide

4. Drag the object to a new location on the page.
5. Release the mouse button to drop the object in its new location.

Overlapping Objects

You can position objects so that one is on top of another. You can control the stacking order to specify which object is positioned in front or behind the other. Overlapping objects have many practical uses when presenting information in the classroom. For example, you can create a "curtain control" by placing an empty text box over other objects. Then, you can move the text box to reveal the items below it one at a time.

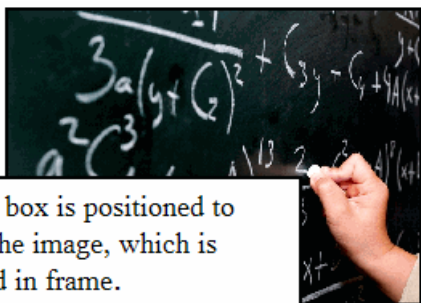

This text box is positioned to overlap the image, which is contained in frame.

To change the position of an object in the stacking order:

1. Click the border of the object you want to position to select it, and then right-click to open the context menu.

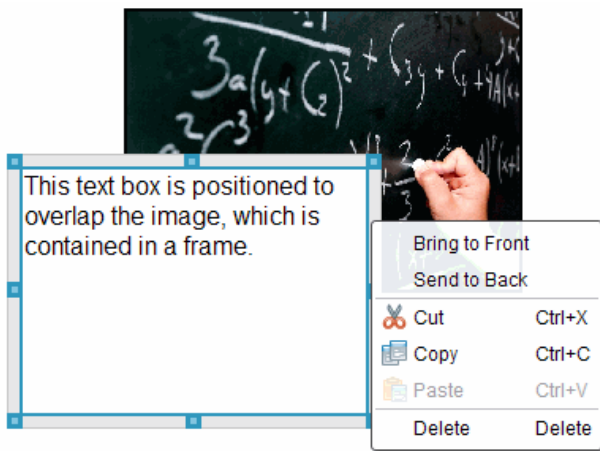

2. Click **Send to back** or **Bring to front** to move the selected object to the desired position.

Deleting an Object

To delete an object from a sheet:

1. Click any border of the object to select it. When an object is selected, the border is blue and the handles are active.
2. Press the **Delete** key to delete the text box.

–or–

Right-click a border, and then click **Delete** from the context menu.

Choosing a Working Folder for PublishView™ Objects

Use the Choose Your Working Folder field in the PublishView™ Objects pane to select a folder for storing PublishView™ documents and related files.

1. Ensure the PublishView™ Objects pane is open.

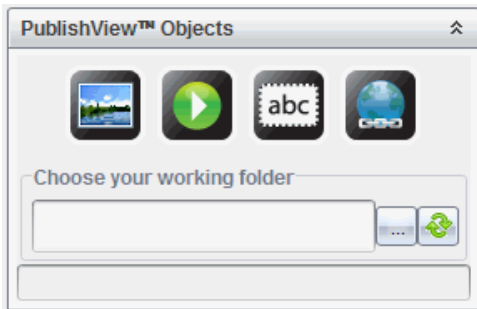

2. Click .

The Choose Your Working Folder dialog box opens.

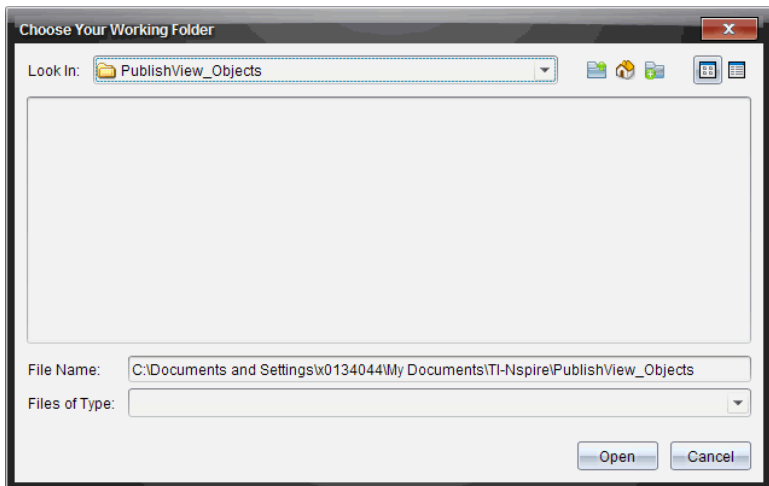

3. Navigate to the folder where you want to store video and image files.
4. Click **Open** to choose the working folder.

The selected folder becomes the working folder and the folder name is displayed in the **Choose your working folder** field. Previews of supported images and video files in the folder are shown in the PublishView™ objects pane.

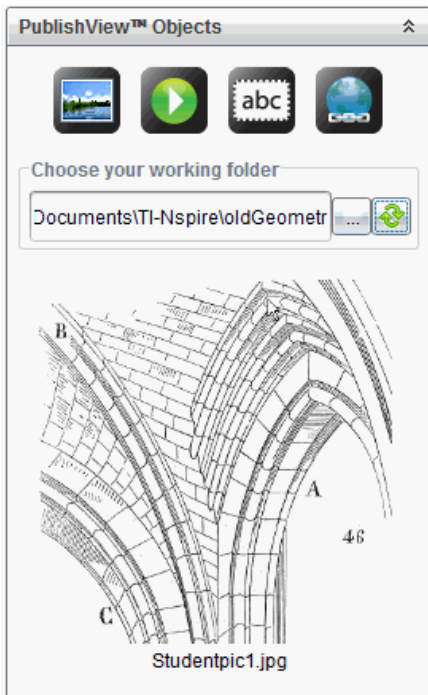

5. To add an image or video file to a PublishView™ document, select the file and move it onto the active sheet.

Working with TI-Nspire™ Applications

Note: For more information, see the appropriate chapter in this guidebook.

Adding an Application to a Problem

To add a TI-Nspire™ application to a problem in a PublishView™ document:

1. Choose one of the following actions to select an application:

- From the TI-Nspire™ Applications pane in the Documents Toolbox, use the mouse pointer to point to the application and drag it to the problem.
- From the menu bar, click **Insert** and choose an application from the drop-down menu.
- Right-click inside the sheet to open the context menu, click **Insert** and choose an application from the menu.

The application is added to the sheet.

Lists & Spreadsheet Problem

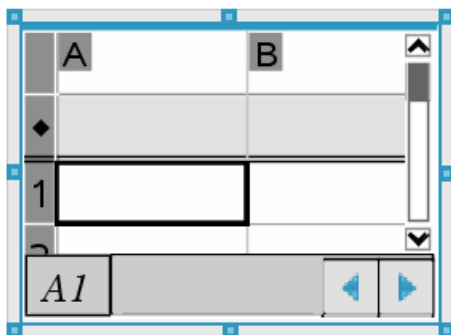

2. Using your mouse, grab the handles to resize or position the application object as needed.
3. Click outside the application frame to accept the dimensions.
4. To open the menu for the active TI-Nspire™ application, click inside the application.

The menu opens in the Documents Toolbox above the TI-Nspire™ Applications pane.

Right-click on an application element, such as a cell or function to open the context menu for that item.

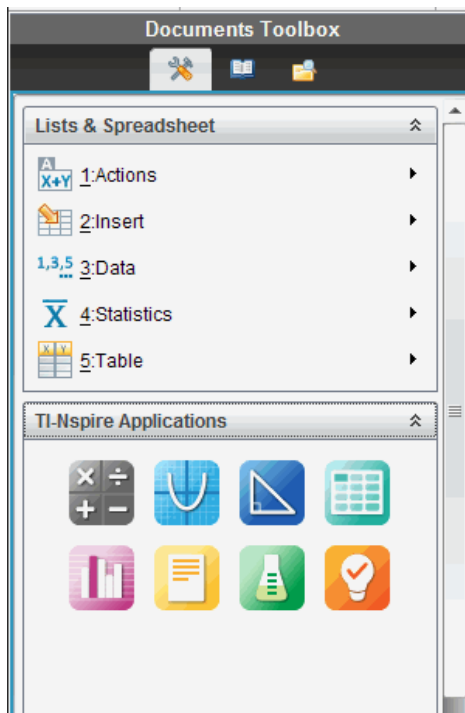

5. To work in the application, click an option from the application menu. Click  to collapse the application menu pane.

Adding Existing TI-Nspire™ Documents

Use the TI-Nspire™ Documents pane to open an existing TI-Nspire™ document to add to a PublishView™ document. When you open an existing TI-Nspire™ document, all pages of the document appear in the preview pane. You can move complete problems or individual pages onto the PublishView™ sheet.

Choosing a Working TI-Nspire™ Document

To choose a working document:

1. In the Documents Toolbox, ensure the TI-Nspire™ Documents pane is open.

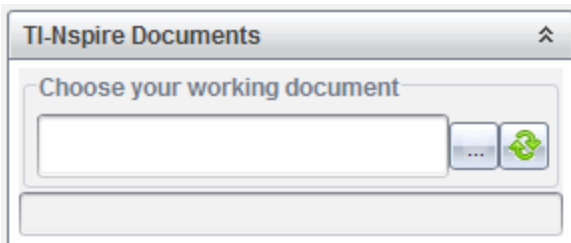

2. Click

The **Choose Your Working Document** dialog box opens.

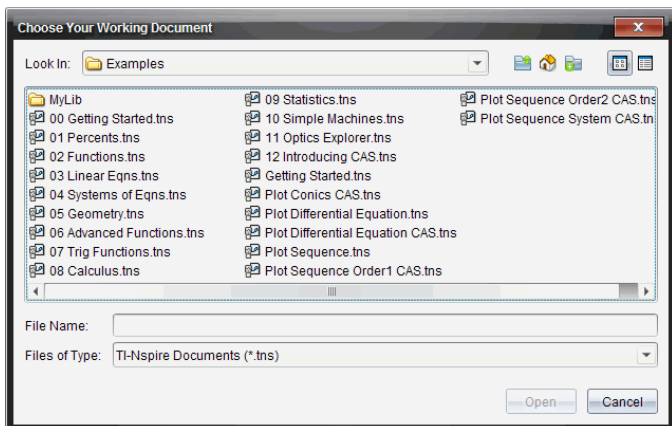

3. Navigate to the folder in which the TI-Nspire™ document is stored:
- Click ▼ in the **Look in:** field to use a file browser to locate a folder.

- From an open folder, click to move up a level in the folder hierarchy

- Click to return to the default home folder

- Click to add a new folder to open folder on your computer.

- Click to list folders and files. To show details, click .

4. Select the file, and then click **Open**.

The TI-Nspire™ document opens in the TI-Nspire™ Documents™ pane.

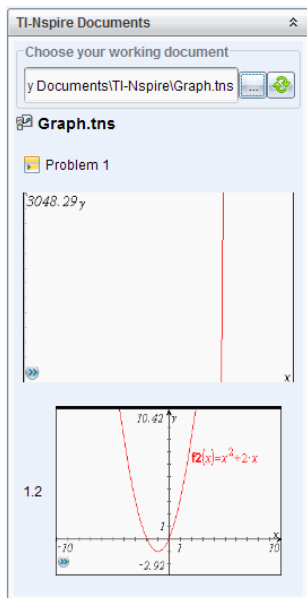

5. To add the TI-Nspire™ document to the PublishView™ document, move one page at a time or one problem at a time to the PublishView™ sheet.

If you are adding a problem with multiple pages, the pages are stacked on top of each other on the PublishView™ sheet. Move the top page to see the other pages.

Working with Problems

Like a TI-Nspire™ document, a PublishView™ document consists of one or more problems.

Problems are used to control the layout of a PublishView™ document so that you can isolate variables. When variables with the same name are used in multiple problems, variables can have different values. To add problems to PublishView™ documents, open the Sheet context menu or use the options on the Insert menu in the Documents Workspace. When adding problems, keep the following guidelines in mind:

- By default, a new PublishView™ document contains one problem.
- You can insert a problem after any existing problem.

- You cannot insert a problem in the middle of an existing problem.
- A new problem break is always inserted after the selected problem.
- Inserting a problem break adds empty space below the break.
- Any object between two problem breaks is part of the problem above the break.
- The last problem includes all sheets and objects below the last problem break.
- Problem breaks are not relative to any object, which lets you move objects within a problem without affecting the problem break location.

Adding a Problem

To add a problem to an open PublishView™ document:

1. Right-click anywhere on the sheet, and then click **Insert > Problem**.

The problem is added to the document below any existing problems. The problem break provides a visible divider between problems.



2. To name the problem, highlight the default text, type a name, and then click outside the text box to save the name.

The problem break is saved.



If a document has multiple problems, use the scroll bar on the right side of the document to move up and down through the problems.

Managing Problem Breaks

Problem breaks are used to separate problems and variable sets.

- Every problem has a problem break.
- A problem break becomes visible when a problem is added to a document.
- A problem break is represented by a dashed line with the name of the problem positioned on the left side of the sheet.
- By default, the problem name is shown as **<Name of problem>**. Highlight the default text to type a new name for the problem.

- Problem names do not have to be unique. Two problems can have the same name.

Hiding and Showing Problem Breaks

You can select to hide or show problem breaks in a PublishView™ document. By default, problem breaks are shown.

1. Right-click in any blank area of the document (outside of any object) to open the sheet context menu.
2. Click **Layout Options**.

The Show/Hide Options dialog box opens.

Note: You can also click **View > PublishView™ Layout Options**.

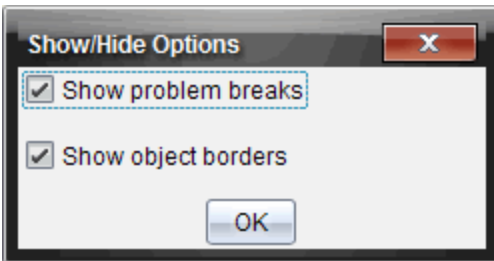

3. Clear the **Show problem breaks** option to hide problem breaks in the document. Select the option to return to the default setting and show the problem breaks.
4. Click **OK** to close the dialog box.

Renaming a Problem

1. Click the existing problem name on the problem break line.
2. Type a new name for the problem.
3. Click outside the text box to save the new name.

Deleting a Problem

To delete a problem, complete one of the following actions:

- ▶ Select the problem break and click  on the right side of the break.
- ▶ Click **Edit > Delete**.

- ▶ Right-click the problem break and click **Delete**.
- ▶ Select the problem break and press the **Delete** or **Backspace** key.

When you delete a problem, all objects contained in the problem are removed and the space between the selected problem break and the next problem break is removed.

Organizing PublishView™ Sheets

A PublishView™ document can have multiple sheets. A single sheet is displayed in the workspace on your screen. All work occurs in the PublishView™ objects and TI-Nspire™ applications within sheets.

Adding Sheets to a Document

To add a sheet to a document:

- ▶ Click **Insert > Sheet**.

The sheet is added to the document and the numbering increments by one.

Opening the Sheet Context Menu

- ▶ Right-click in any blank area (outside of any object) in a PublishView™ sheet.

A context menu opens with options for inserting problems, pages, applications, and PublishView™ objects, edit options for removing space or deleting a page, and options for hiding and showing problem breaks and object borders.

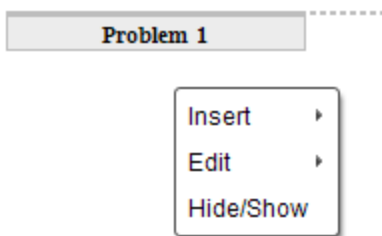

Page Numbering

In a PublishView™ document, page numbering is displayed in the bottom margin (footer). By default, numbering is placed in the center of the

PublishView™ sheet in a # of # format. You cannot edit or delete page numbering.

Working with Headers and Footers

PublishView™ documents contain space at the top and bottom of a sheet to add a header or a footer. Headers and footers can contain the date, the document name, the lesson plan name, the class name, your school's name, or any other information needed to identify a document.

By default, headers and footers do not contain content and boundaries for the header and footer are hidden. To activate a header or footer for editing, click inside the top or bottom margin. When activated, a text box with a light gray border is displayed.

Inserting and Editing Text in Headers and Footers

1. Click inside the top or bottom margin.

The text box borders in the margin become visible and the object space is disabled. The cursor is placed in the header or footer space and the formatting toolbar becomes active.

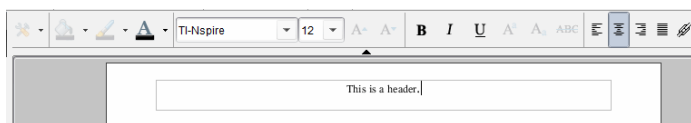

2. Type the text.
 - The default font is TI-Nspire™ true type, 12 pt, normal.
 - By default, text is centered horizontally and vertically.
 - Text can be aligned: left, center, right, or justified.
 - Text that does not fit within the text box horizontally will wrap to the next line.
 - Text that does not fit within the text box vertically will not be shown, but text is retained. (If you delete text, the hidden text will appear.)
3. Complete one of the following actions to save the text:
 - Single-click anywhere outside the header or footer text box to save the text.
 - Press **Esc** to save the text.

The PublishView™ sheet becomes active and the formatting menu closes.

Showing and Hiding Borders

By default, borders are displayed when you insert an object into a problem. When you select to hide borders, the selection applies to all objects in the document and to objects that you add to the document. To hide the border:

1. Right-click in any blank area of the sheet (outside of any object) to open the context menu.
2. Click **Layout Options**.

The Layout Options dialog box opens.

Note: You can also click **View > PublishView™ Layout Options**.

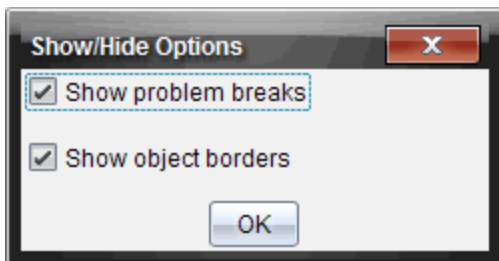

3. Clear the **Show object borders** option to hide the borders around the objects in the problem. Select the option to return to the default setting and show borders.
4. Click **OK** to close the dialog box.

Adding and Removing Space

To manage how PublishView™ objects appear on a sheet, you may need to add or delete space between objects.

Note: You can add and remove vertical space between objects using this method. To add or remove horizontal space between objects, move the object.

Adding Space

1. Right-click in the area outside of any object where you want to add space. The context menu opens.

2. Click **Edit > Add/Remove Space**. The Add/Remove Space tool becomes active.



Drag up and press enter to remove space

Drag down and press enter to add space

Add/Remove
Space tool



3. Use your mouse to position the tool to the exact place where you want to add space.
4. Click the tool, and then drag **down** to select the amount of space you want to add. As you select the amount of space to be added, it is indicated in green.



Drag up and press enter to remove space

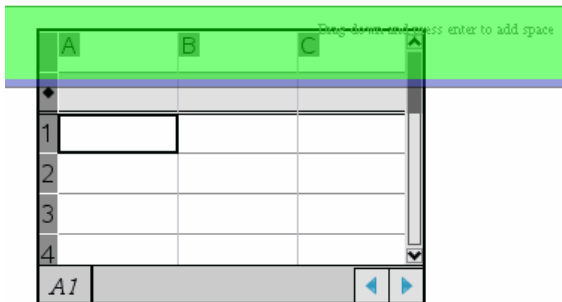

Drag down and press enter to add space

5. Press the **Enter** key to add the space in between the objects. You can adjust the amount of space by dragging up and down before you press **Enter**.

Removing Space

1. Right-click in the area outside of any object where you want to remove space.
The context menu opens.
2. Click **Edit > Add/Remove Space**.
The Add/Remove Space tool becomes active.



Drag up and press enter to remove space

Drag down and press enter to add space



Add/Remove Space tool

3. Use your mouse to position the tool to the exact place where you want to remove space.
4. Click the tool, and then drag **up** to select the amount of space you want to remove. As you select the amount of space to be removed, it is indicated in red.

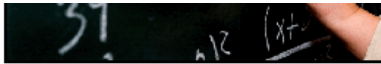

Drag up and press enter to

Drag down and press enter

	A	B	C
◆			
1			
2			
3			
4			
A1			

5. Press the **Enter** key to remove the space in between the objects. You can adjust the amount of space by dragging up and down before you press **Enter**.

Note: If there is not enough space on the sheet to accommodate the objects, the objects won't be moved when space is removed.

Deleting Blank Sheets from Problems

You can delete a sheet that does not contain any TI-Nspire™ applications or PublishView™ objects from a problem. To delete a blank sheet from a problem:

1. Delete any TI-Nspire™ applications, PublishView™ objects, move or delete any problem breaks from the sheet.
2. Place your cursor inside the sheet you want to delete.
3. Right-click inside the blank sheet to open the context menu.
4. Click **Edit > Delete Sheet**.

The blank sheet is removed from the problem.

Using Zoom

The zoom feature lets you zoom in on any object or area on the PublishView™ document for discussion, and zoom out to see an overview of the lesson. The zoom uses the center point of the viewable area to zoom in.

The default zoom setting is 100%.

- ▶ To change the zoom percentage, do one of the following:
 - Type the number in the box and press **Enter**.
 - Use the - and + buttons to decrease or increase the percentage in 10% increments.
 - Use the drop-down arrow to choose a preset percentage.

The zoom settings are retained when you save the document.

Adding Text to a PublishView™ Document

In a PublishView™ document, there are three ways to add text:

- Insert a PublishView™ text box to enter free-form text or copy text from other sources into the document. For example, you can place a PublishView™ text box next to an image and type a description in a text

box. You can also copy and paste text from .doc, .txt, and .rtf files. Use PublishView™ text boxes when you need options for emphasizing and formatting text. PublishView™ text boxes are not converted when you convert a PublishView™ document to a TI-Nspire™ document. You may want to use a PublishView™ text box to add text that you don't want handheld users to see.

- Use the TI-Nspire™ Notes application. You should use the Notes application when you need an advanced equation editor and when you need to use TI-Nspire™ math templates and symbols. Superscript and subscript are also easier to use in the Notes application. You should also use Notes when you are planning to convert the PublishView™ document to a TI-Nspire™ document for use on a handheld and you want handheld users to see the text.
- Add text in TI-Nspire™ applications that allow text just as you would in a TI-Nspire™ document.

Inserting Text into a Text Box

1. Ensure the PublishView™ Objects pane is open.

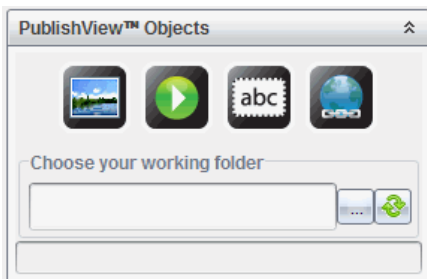

2. Use your mouse to click  and drag it to the problem.
3. Release the mouse button to drop the text box into the problem.

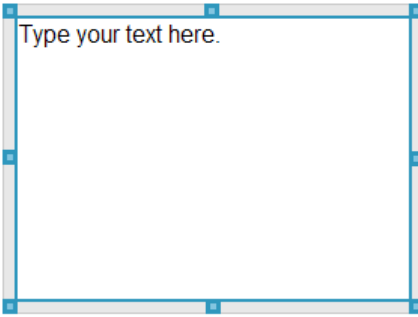

4. Using the mouse, grab the handles to resize the text box or position in the problem as needed.
5. Click outside the text box to save the size and position.
6. Click "Type your text here."

The formatting toolbar becomes active. The text box is in an interactive state for adding or editing text.

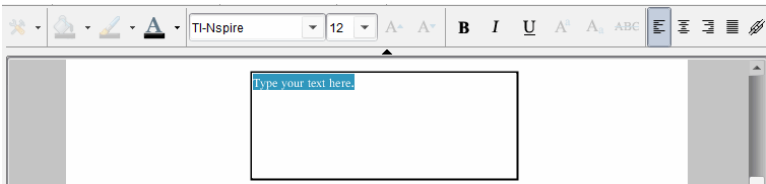

7. Type the new text.
—or—
Copy and paste text from another file.
8. Apply formatting as needed.
9. Click outside the text box to save the text.

Formatting and Editing Text

The options for editing and formatting text are located on a formatting toolbar at the top of the active document. Formatting options for editing text include:

- Changing the font, font size, and font color.
- Applying bold, italics, and underline formatting.
- Applying the following text horizontal alignment options: left, right, centered, and justified.

- Inserting hyperlinks.

Launching Edit Mode

- ▶ Click inside a text box to launch edit mode.
 - The formatting menu opens.
 - The text is selectable for editing.

Opening the Content Context Menu

- ▶ Right-click inside a text box containing text or a hyperlink.

The formatting menu and context menu open providing shortcuts to cut, copy, and paste.

Using Hyperlinks in PublishView™ Documents

In PublishView™ documents, use hyperlinks to:

- Link to a file
- Link to a website on the Internet

You can add a hyperlink to an open document or you can convert any text within a text box to a hyperlink. When a hyperlink is added, the formatting of the text is underlined and the font color is blue. You can change the formatting of the hyperlinked text without losing the hyperlink.

If a link is broken, an error message is displayed when you click the link:

- Cannot open the specified file
- Cannot open the specified web page

PublishView™ text boxes support both absolute and relative links.

Absolute links contain the complete location of the linked file and do not depend on the location of the main document.

Relative links contain the location of the linked file relative to the main document. If you have multiple lessons in a single folder and they are all linked using relative addressing, you can move the folder to any other location (another local folder, datashare, flash drive, online) without breaking the links. The links also stay intact if you bundle the documents into a lesson bundle or zip them into a zip file and share them.

Note: The PublishView™ document must be saved before you can insert a relative hyperlink.

Linking to a File

You can link to any file on your computer. If the file type is associated with an application on your computer, it will launch when you click the link. There are two ways to link to a file; by typing or pasting a file address into the Address field, or by browsing to a file.

Linking to a File by Using an Address

1. Ensure the PublishView™ Objects pane is open.

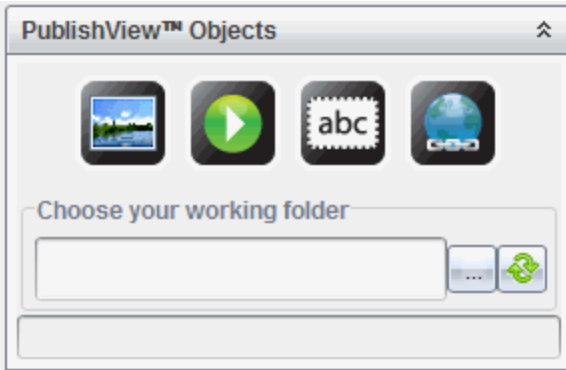

2. Drag the hyperlink icon  onto the document.

The Hyperlink dialog box opens.

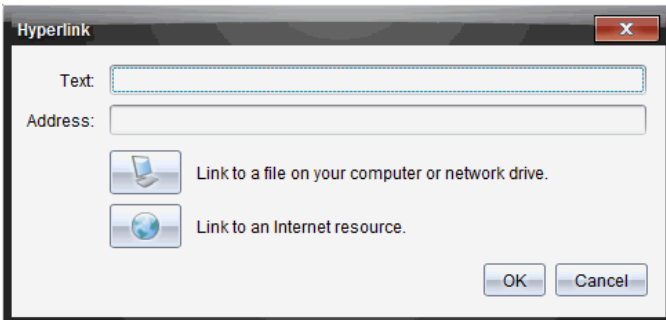

3. Type the name of the link in the Text field. For example, this can be the name of the document.

- Copy the location of the file path you want to link to, and paste it in the Address field.

–or–

Type the location of the file in the Address field.

Note: Type `../` to designate parent directories. For example:

`../..lessons/mathlesson2.tns`

- Click **OK** to insert the link.

A text box containing the hyperlink is added to the PublishView™ document.

Linking to a File by Browsing

- Ensure the PublishView™ Objects pane is open.

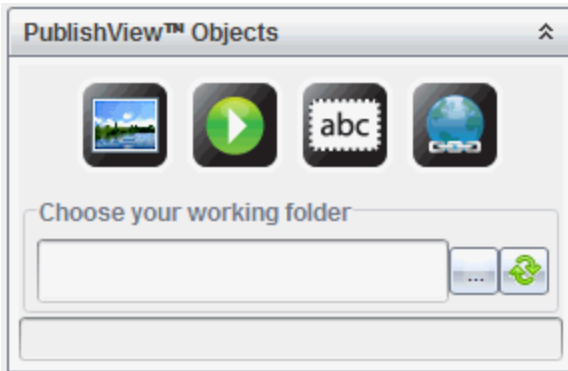

- Drag the hyperlink icon onto the document.

The Hyperlink dialog box opens.

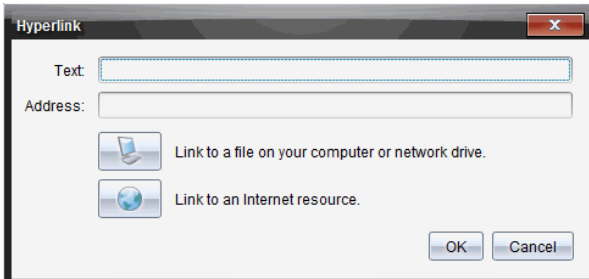

3. Type the name of the link in the Text field. For example, this can be the name of the document.

4. Click  to select **Link to a file on your computer or network drive**.

The **Select file to insert as hyperlink** dialog box opens.

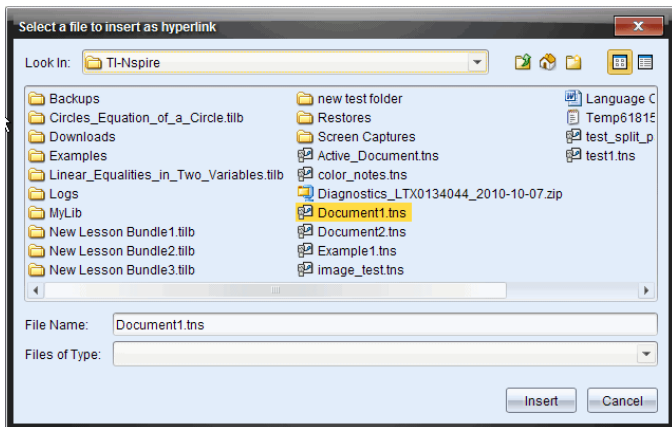

5. Navigate to and select the file you want to link to, and then click **Insert**.

The path name is inserted into the Address field in the Hyperlink dialog box.

If the software is unable to determine if the link is a relative or absolute address, the Hyperlink dialog box opens with an option to change the type of link.

To change the link, click the appropriate option:

- **Change to absolute address.**
- **Change to relative address.**

6. Click **OK** to insert the link.

—or—

Click **Start Over** to go back to the Hyperlink dialog box and choose a different file to link, or to edit the Text or Address fields.

A text box containing the hyperlink is added to the PublishView™ document.

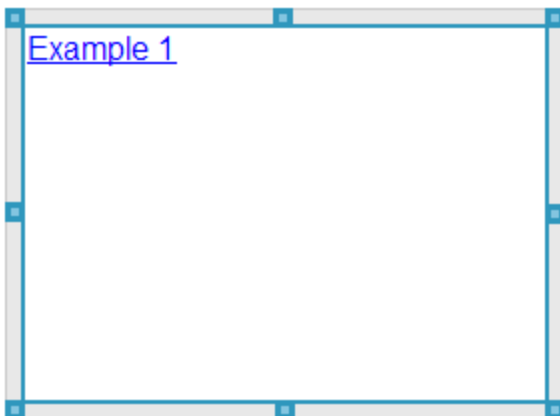

7. Using the mouse, grab the handles to resize the text box.

–or–

Grab any border to position the text box in the document as needed.

Linking to a Website

There are two ways to link to a website; by typing or pasting the URL into the Address field, or by browsing to a file.

Linking to a Website by Using an Address

1. Ensure the PublishView™ Objects menu is open.



2. Drag the hyperlink icon onto the document to open the Hyperlink dialog box.
3. Type or paste the URL you want to link to in the Address field.
4. Click **OK**.

A text box containing the hyperlink is added to the PublishView™ document.

Linking to a Website by Browsing

1. Ensure the PublishView™ Objects menu is open.



2. Drag the hyperlink icon onto the document to open the Hyperlink dialog box.

3. Click  to select **Link to an Internet resource**.

The browser opens to your default website.

4. Navigate to the website or file on a website that you want to link to.

5. Copy the URL, and then paste it in the Address field in the Hyperlink dialog box.

–or–

Type the URL in the Address field.

6. Click **OK**.

A text box containing the hyperlink is added to the PublishView™ document.

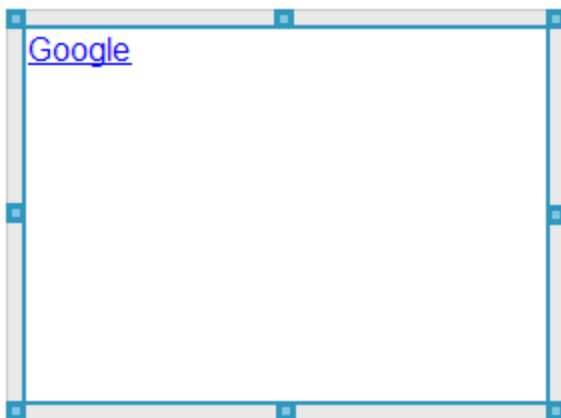

7. Using the mouse, grab the handles to resize the text box.

–or–

Grab any border to position the text box in the document as needed.

Editing a Hyperlink

To change the name of a hyperlink, change the path, or change the URL, complete the following steps.

1. Using your mouse, right-click the hyperlink text, and then click **Edit hyperlink**.

The Hyperlink dialog box opens.

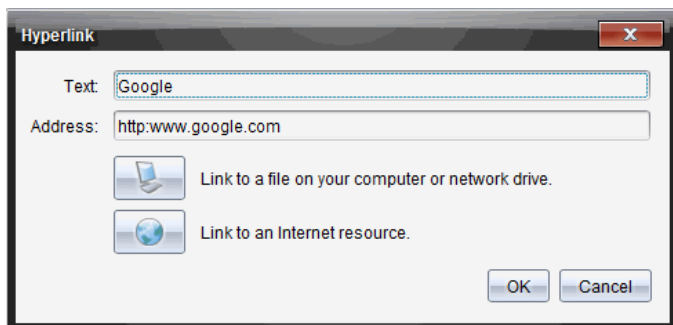

2. Make corrections as needed:

- Type corrections to the hyperlink name in the **Text** field.

- Click  to open the **Select a file to add as a hyperlink** dialog box and use the file browser to navigate to the folder where the file is located.

- Click  to open a browser and navigate to a website to copy and paste the correct the URL in the **Address** field.

3. Click **OK** to save the changes.

Converting Existing Text to a Hyperlink

1. Click inside the text box to activate edit mode and open the formatting menu.
2. Select the text you want to convert to a hyperlink.

3. Click .

The Hyperlink dialog box opens with the selected text in the Text field.

4. Click  to create a link to a file.
–or–

Click  to create a link to page on a website.

Removing a Hyperlink

Use this process to remove a link from text inside a text box. The text remains in the document.

1. Using your mouse, right-click the hyperlink text.
2. Click **Remove hyperlink**.

The hyperlink formatting is removed from the text and the text is no longer clickable.

Note: To remove both the text and hyperlink, delete the text. If a text box contains only the linked text, delete the text box.

Working with Images

Images can be added to PublishView™ documents as PublishView™ objects or can be added inside TI-Nspire™ applications that support images. Supported files types are .bmp, .jpg, and .png files.

Note: If a TI-Nspire™ application is active in the PublishView™ document, the image is added to the TI-Nspire™ page if you click **Insert > Image** from the menu bar or context menu. If there is no TI-Nspire™ document active, the image is added as a PublishView™ object. Only images inside TI-Nspire™ applications convert to TI-Nspire™ documents (.tns files).

Inserting an Image

1. Ensure the PublishView™ Objects pane is open.

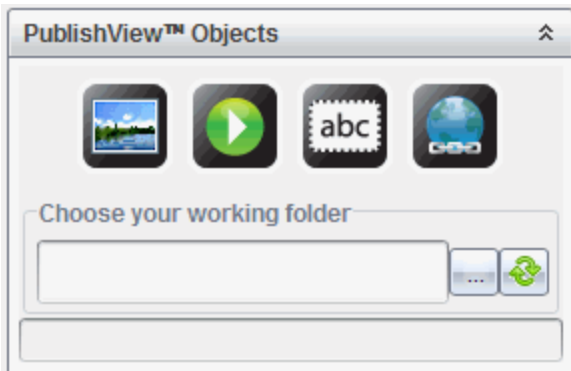

2. Click , and then drag the icon to the document.

The **Choose an image to insert into PublishView™** dialog box opens.

Note: By default, the Texas Instruments preloaded images folder is displayed.

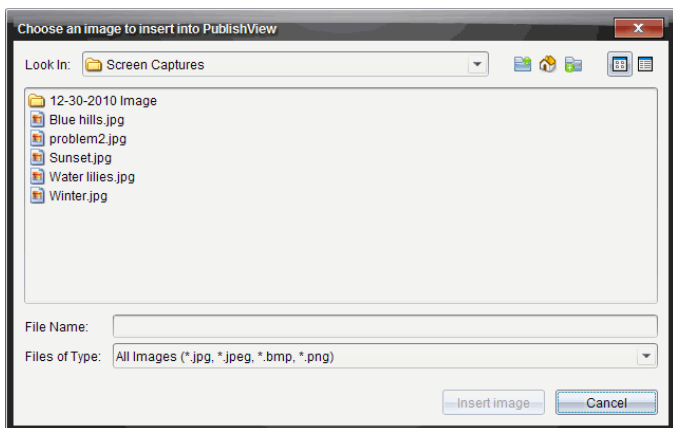

3. Navigate to the folder where the image file you want to insert is located, and then highlight the file name.
4. Click **Insert image**.

The image is added to the PublishView™ sheet.



- Using the mouse, grab the handles to resize the text box,
–or–
Grab any border to position the text box in the document as needed.

Moving Images

- Click the frame containing the image to select it.
- Move your cursor over the edge of the image to activate the positioning tool. 
- Move the image to its new location on the PublishView™ sheet.
Note: Objects can overlap each other on a PublishView™ sheet.

Resizing Images

- Click the frame containing the image to select it.
- Move your cursor over one of the blue handles to activate the resizing tool. 
- Drag the handle to make the image smaller or bigger.

Deleting Images

- Click the image to select it, and then press the **Delete** key.
–or–
- Right-click a handle to open the context menu, and then click **Delete**.

Working with Video Files

You can embed video files in a PublishView™ document and play the videos directly from the PublishView™ document. Supported video formats include:

- Flash® (.flv) video files with VP6 video and MP3 audio.
- MP4 (MPEG-4 multimedia container) with H264/AVC (Advanced Video Coding) video compression and AAC audio.

Note: You can also insert a link to a video that will launch in a new browser window or media player window. For more information, see *Working with Hyperlinks*.

Inserting a Video

1. Ensure the PublishView™ Objects pane is open.
2. Click , and then drag the icon to the document.

The **Choose a video to insert into PublishView™** dialog box opens.

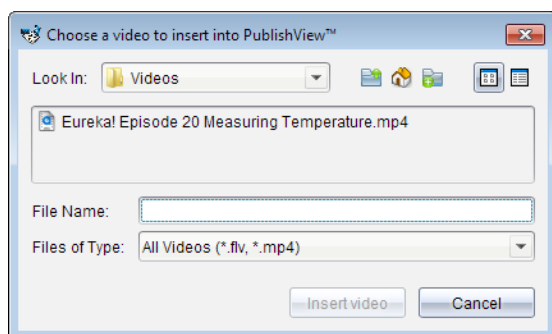

3. Navigate to the folder where the video file you want to insert is located, and select the file name.
4. Click **Insert video**.

An object containing the embedded video is added to the PublishView™ sheet. By default, the resizing and positioning handles are active.



5. Using the mouse, grab the handles to resize the object or grab any border to position the object in the document as needed. For example, you may want to position the object containing the video above or below a text box that contains text introducing the video.
6. To play the video, click the forward arrow, or click anywhere in the viewing window.

Using the Video Console

The video console lets users control the video.



- 1 Starts or stops the video.
- 2 Shows the elapsed time as the video plays.
- 3 Mutes or unmutes the audio.

Converting Documents

You can convert PublishView™ documents (.tnsp files) to TI-Nspire™ documents (.tns files) for display on handhelds. You can also convert TI-Nspire™ documents to PublishView™ documents.

Converting a document creates a new document—the original document remains intact and is not linked to the new document. If you make changes to one document, the changes are not reflected in the other document.

Converting PublishView™ Documents to TI-Nspire™ Documents

You cannot open a PublishView™ document (.tnsp file) on a handheld. However, you can convert the PublishView™ document to a TI-Nspire™ document that can be transferred to and opened on a handheld. When you convert a PublishView™ document to a TI-Nspire™ document:

- Only the TI-Nspire™ applications become part of the TI-Nspire™ document.
- PublishView™ objects such as text boxes, images, hyperlinks, and videos are not converted.
- Text contained in PublishView™ text boxes is not converted; however, text in a TI-Nspire™ Notes application is converted.
- If images are contained in a TI-Nspire™ application, they are converted; however, images contained in PublishView™ objects are not converted.

Complete the following steps to convert a PublishView™ document (.tnsp file) to a TI-Nspire™ document (.tns file).

1. Open the PublishView™ document to be converted.
2. Click **File > Convert to > TI-Nspire™ Document**.
 - The new TI-Nspire™ document opens in the Documents Workspace.
 - All supported TI-Nspire™ applications are part of the new TI-Nspire™ document.
 - Starting from top to bottom, and then left to right, the layout of the TI-Nspire™ document is based on the order of the TI-Nspire™ applications in the PublishView™ document.
 - Every TI-Nspire™ application in a PublishView™ document will appear as a page in the converted TI-Nspire™ document. The order of the pages in the TI-Nspire™ document is based on the layout of the TI-Nspire™ applications in the PublishView™ document.
 - If two or more problems are at the same level, the order is left to right.
 - Problem breaks are maintained.

- The new TI-Nspire™ document is not linked to the PublishView™ document.

3. When work in the document is complete, click  to save the document in the current folder.

–or–

Click **File > Save As** to save the document in a different folder.

Note: If the document has never been saved, both the **Save** and **Save as** options allow saving in a different folder.

Note: You can also use the **Save as** option to convert a PublishView™ document to a TI-Nspire™ document.

Note: If you try to convert a PublishView™ document that does not contain TI-Nspire™ pages or applications, an error message is displayed.

Converting TI-Nspire™ Documents to PublishView™ Documents

You can convert existing TI-Nspire™ documents to PublishView™ documents, which enables you to take advantage of the richer layout and editing features for printing, generating student reports, creating worksheets and assessments, and publishing documents to a website or blog.

Complete the following steps to convert a TI-Nspire™ document to a PublishView™ document:

1. Open the TI-Nspire™ document you want to convert.
2. Click **File > Convert to > PublishView™ Document**.
 - The new PublishView™ document opens in the Documents Workspace.
 - By default, there are six objects per page.
 - When converted, each problem from the TI-Nspire™ document will start a new sheet in the PublishView™ document.
 - Problem breaks are maintained.

3. When work in the document is complete, click  to save the document in the current folder.

–or–

Click **File > Save As** to save the document in a different folder.

Note: You can also use the **Save as** option to save a TI-Nspire™ document as a PublishView™ document.

Printing PublishView™ Documents

You can print reports, worksheets, and assessments created using the PublishView™ feature. To print a document:

1. Click **File > Print**.

The Print dialog box opens. A preview of the document is shown on the right side of the dialog box.

2. Select a printer from the menu.

Note: The **Print what** field is disabled.

3. Select **Paper Size** from the menu. Options are:

- Letter (8.5 x 11 inches)
- Legal (8.5 x 14 inches)
- A4 (210 x 297 mm)

4. Select or type the number of **Copies** you want to print.

5. In the **Print Range** area, select to print all sheets in the document, a range of sheets, or the current sheet only.

Note: By default, top and bottom margins are set to one-inch and are maintained when printing a PublishView™ document. There are no side margins. PublishView™ sheets print just as they appear in the workspace.

6. If needed, select or clear the boxes to:

- Print problem breaks and names.
- Print headers
- Print footers
- Print object borders

7. Click **Print**, or click **Save As PDF**.

Working with Lesson Bundles

Many lessons or activities contain multiple files. For example, teachers usually have a teacher version of a file, a student version, assessments, and sometimes supporting files. A lesson bundle is a container that enables teachers to group all files needed for a lesson together. Lesson bundles are used to:

- Add any type of file (.tns, .tnsp, .doc, .pdf, .ppt) to a lesson bundle.
- Send lesson bundles to connected handhelds or laptops; however, only the .tns files are sent to the handheld.
- View all the files in a lesson bundle using the TI-Nspire™ software.
- Group all files associated with one lesson in one place.
- Email one lesson bundle file to teachers or students instead of looking for and attaching multiple files.

Creating a New Lesson Bundle

Teachers and students can create new lesson bundles in the Documents Workspace. Teachers can also create new lesson bundles in the Content Workspace.

Creating a Lesson Bundle in the Documents Workspace

Complete the following steps to create a new lesson bundle. By default, the new lesson bundle does not contain files.

1. Click  in the Documents Toolbox to open the Content Explorer.
2. Navigate to the folder where you want to save the lesson bundle file.

3. Click  to open the menu, and then click **New Lesson Bundle**.

The new lesson bundle file is created with a default name and placed in your list of files.

4. Type a name for your lesson bundle.
5. Press **Enter** to save the file.

Creating Lesson Bundles in the Content Workspace

In the Content Workspace, teachers have two options for creating lesson bundles:

- When files needed for a lesson bundle are located in different folders, create an empty lesson bundle, and then add files to the lesson bundle.
- If all needed files are located in the same folder, create a lesson bundle with selected files.

Creating an Empty Lesson Bundle

Complete the following steps to create a lesson bundle that does not contain files.

1. Navigate to the folder on your computer where you want to save the lesson bundle.

Note: If you are using the software for the first time, you may need to create a folder on your computer before creating a lesson bundle.

2. Click  or click **File > New Lesson Bundle**.

The new lesson bundle file is created with a default name and placed in the list of files.

3. Type a name for the lesson bundle and press **Enter**.

The lesson bundle is saved with the new name and details are shown in the Preview pane.

Creating a Lesson Bundle Containing Files

You can select multiple files within a folder, and then create the lesson bundle. You cannot add a folder to a lesson bundle.

1. Navigate to the folder that contains the files you want to bundle.
2. Select the files. To select multiple files, select the first file then hold down **Shift** and click the last file in the list. To select random files, select the first file, and then hold down **Ctrl** and click the other files to select them.

3. Click , and then click **Lesson Bundles > Create New Lesson Bundle from selected**.

A new lesson bundle is created and placed in the open folder. The lesson bundle contains copies of the selected files.

4. Type a name for the lesson bundle and press **Enter**.

The lesson bundle is saved in the open folder and the details are shown in the Preview pane.

Adding Files to a Lesson Bundle

Use any of the following methods to add files to a lesson bundle:

- Drag any file into a selected lesson bundle. This method moves the file to the lesson bundle. If you delete the lesson bundle, the file is deleted from your computer. You can recover the file from the Recycle Bin.
- Copy and paste any file into a selected lesson bundle.
- Use the "Add files to lesson bundle" option. This method copies the selected files into the lesson bundle. The file is not moved from its original location.

Using the Add Files to Lesson Bundle Option

Use this option to add files to an empty lesson bundle or add more files to an existing lesson bundle.

1. Use one of the following options to select the lesson bundle file.
 - When working in the Documents Workspace, open the Content Explorer, and then double-click the lesson bundle file name.
 - When working in the Content Workspace, double-click the lesson bundle name.

Note: In the Content Workspace, you can also click the lesson bundle name to open the Files dialog box in the Preview pane. The Add Files to Lesson Bundle option is available from the Files dialog box. If the lesson bundle already contains files, the first file in bundle is shown in the Files dialog box.

The lesson bundle dialog box opens. The name reflects the name of the lesson bundle.

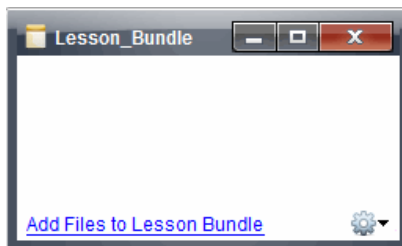

2. Click **Add Files to Lesson Bundle**.

The Add dialog box opens.

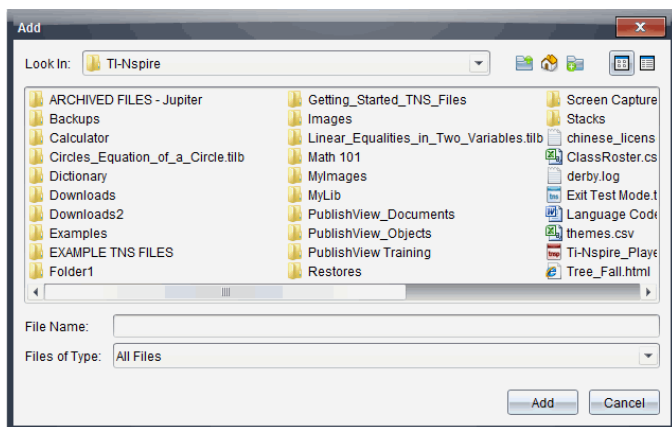

3. Navigate to and select the file you want to add to the lesson bundle.
 - You can select multiple files at one time if they are located in the same folder.
 - If files are located in different folders, you can add them one at a time.
 - You cannot create a folder within a lesson bundle or add a folder to a lesson bundle.
4. Click **Add** to add the file to the bundle.

The file is added to the bundle and is now listed in the lesson bundle dialog box.
5. Repeat this process until all needed files are added to the lesson bundle.

Opening a Lesson Bundle

To view and work with files within a lesson bundle, complete one of the following steps to open the lesson bundle file.

- ▶ Double-click the lesson bundle name.
- ▶ Select the lesson bundle, and then right-click and click **Open**.
- ▶ Select the lesson bundle, click , and then click **Open**.
- ▶ Select the lesson bundle, and then press Ctrl + O. (Mac®: ⌘ + O).

When you open a lesson bundle, the files in the bundle are displayed in a separate dialog box.

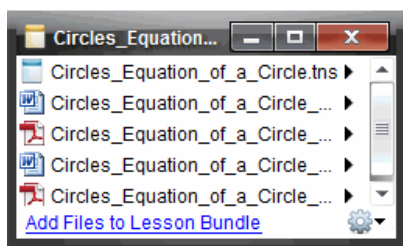

Note: You cannot open a lesson bundle outside of the TI-Nspire™ software. For example, if you open the folder using the file manager on your computer and double-click the lesson bundle name, it does not automatically launch the TI-Nspire™ software.

Opening Files Within a Lesson Bundle

You can open any file within a lesson bundle on your computer if you have the program associated with the file type.

- When you open a .tns or .tnsp file, the file opens in the Documents Workspace in the TI-Nspire™ software.
- When you open another file type, it launches the application or program associated with that file. For example, if you open a .doc file, it opens in Microsoft® Word.

Use one of the following options to open a file within a lesson bundle:

- ▶ Double-click the lesson bundle, and then double-click a file within the lesson bundle.

- ▶ Within a lesson bundle, select the file, and then click ▶ or right-click the file name and select **Open**.

Managing Files in a Lesson Bundle

You can open, copy/paste, delete, and rename files in an existing lesson bundle. To locate and work with files in an existing lesson bundle:

1. Choose one of the following options to locate an existing lesson bundle.
 - When working in the Documents Workspace, open the Content Explorer (click  in the Documents Toolbox), and then navigate to the folder where the lesson bundle is located.
 - When working in the Content Workspace, navigate to the folder where the lesson bundle is located in Content pane.

Note: When you click a lesson bundle name in the Content pane, the Files dialog box opens in the Preview pane. Select a file and right-click to open the context menu.

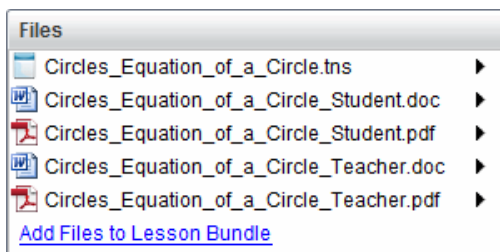

2. Double-click the lesson bundle name to open the Lesson Bundle dialog box.

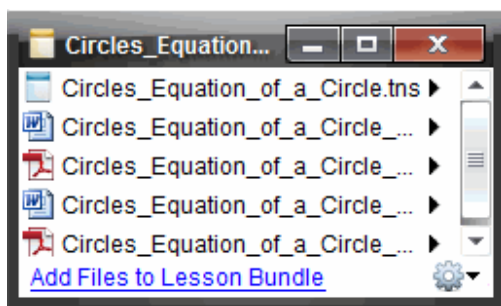

3. Select the file you want to work with and click ▶ to open the context menu.

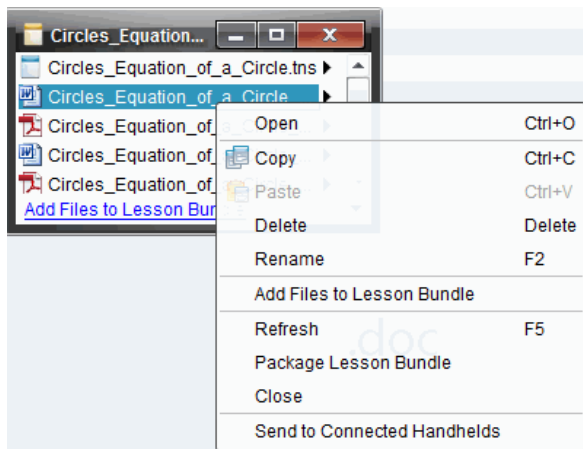

4. Click the action you want to perform:
- Click **Open**. TI-Nspire™ and PublishView™ documents open in the Documents Workspace. When you open another file type, it launches the application or program associated with that file.
 - Click **Copy** to place the file in the Clipboard.
 - Navigate to a folder on your computer or select a connected handheld or laptop, and then right-click and click **Paste** to place the copied file in a new location.
 - Click **Delete** to delete a file from the lesson bundle. Use caution when deleting a file from a lesson bundle. You should ensure files contained in the bundle are backed up if you need the files for future use.
 - Click **Rename** to give the file a new name. To cancel this action, press **Esc**.
 - Click **Add Files to Lesson Bundle** to select and add files to the bundle.
 - Click **Refresh** to update the list of files in the bundle.
 - Click **Package Lesson Bundle** to create a .tilb file
 - Click **Send to Connected Handhelds** to open the Transfer Tool and send the selected file to connected handhelds. You can send .tns files and OS files.

Note: This option is not available in the TI-Nspire™ Navigator™ NC Teacher Software.

- When finished, click **Close** to close the dialog box.

Managing Lesson Bundles

Use the options menu or the context menu to copy, delete, rename, or send a lesson bundle to connected handhelds or laptops. You cannot add a folder to a lesson bundle.

Managing Lesson Bundles in the Documents Workspace

- Open the Content Explorer, and then right-click the lesson bundle name or click  to open the context menu.

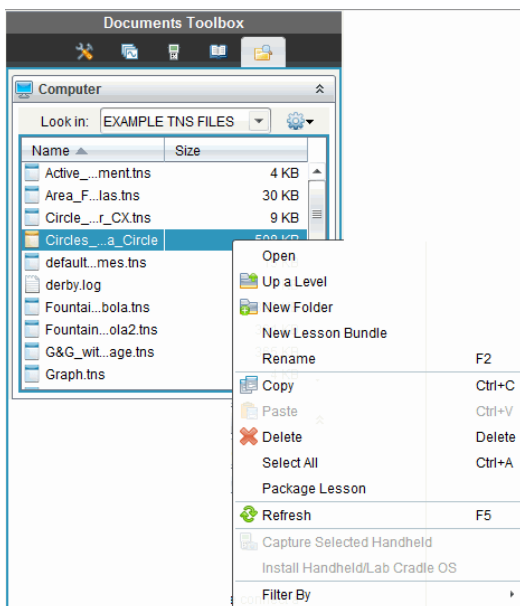





- Click the action you want to perform. If an action is not available, it is dimmed.
 - Click **Open** to open the lesson bundle.
 - Click **Up One Level** to navigate up a level in the folder hierarchy.

- You cannot add a folder to a lesson bundle. If you click **New Folder**, a new folder is added to the folder where the lesson bundle is stored.
- Click **New Lesson Bundle** to create a new lesson bundle. The new lesson bundle is not added to the existing lesson bundle—it is created in the same folder as the existing lesson bundle.
- Click **Rename** to change the name of the lesson bundle. Press **Esc** to cancel this action.
- Click **Copy** to copy the lesson bundle to the Clipboard.
- Navigate to another folder, and then click **Paste** to copy the lesson bundle in another location.
- Click **Delete** to delete the lesson bundle. Use caution when deleting a lesson bundle. You should ensure files contained in the bundle are backed up if you need the files for future use.
- **Select All** highlights all files in the open folder. This action does not apply to lesson bundles.
- Click **Package Lesson** to create a .tilb file.
- Click **Refresh** to update the list of files in the open folder.

Managing Lesson Bundles in the Content Workspace

1. Click **Computer Content** in the Resources pane.
2. In the Content pane, navigate to the lesson bundle you want to work with, and then right-click to open the context menu or click  to open the menu of options.

Open	Ctrl+O
 Copy	Ctrl+C
 Paste	Ctrl+V
 Delete	Delete
Refresh	Ctrl+R
Rename	F2
 Up a Level	Alt+Up
 New Folder	Ctrl+Shift+N
Create Shortcut...	
Lesson Bundles	▶
Send to Connected Handhelds	
Filter by	▶

3. Select the action you want to perform:
 - Click **Open** to open the lesson bundle.
 - Click **Copy** to place the lesson bundle file in the Clipboard.
 - Navigate to a folder on your computer or select a connected handheld, and then right-click and click **Paste** to place the copied file in a new location.
 - Click **Delete** to delete the lesson bundle. Use caution when deleting a lesson bundle. You should ensure files contained in the bundle are backed up if you need the files for future use.
 - Click **Refresh** to update the list of files in the bundle.
 - Click **Rename** to give the lesson bundle a new name. To cancel this action, press **Esc**.
 - To move up a level in the folder hierarchy, click **Up a Level**.
 - To add the lesson bundle to the list of shortcuts in Local Content, click **Create Shortcut**.
 - To add more files to the lesson bundle, click **Lesson Bundles > Add Files to Lesson Bundle**.
 - Click **Lesson Bundles >Package Lesson Bundle** to create a .tilb file.
 - Click **Send to Connected Handhelds** to open the Transfer Tool and send the lesson bundle to connected handhelds. (This option is not available in the TI-Nspire™ Navigator™ NC Teacher Software software.)

Packaging Lesson Bundles

Packaging lesson bundles creates a "package" folder with a .tilb file. This file contains all files contained in the lesson bundle. You must package the lesson before you can email the lesson bundle (.tilb file) to colleagues or students. By default, the lesson bundle is saved in the following folder:

...\\TI-Nspire\\New Lesson Bundle 1.tilb\\package\\...

Packaging a Lesson in the Documents Workspace

1. Open the Content Explorer.
2. Navigate to the folder where the lesson bundle is saved.
3. Select the lesson bundle you want to package.

4. Right-click to open the context menu, and then click **Package Lesson**.

The Lesson Bundle dialog box opens confirming that the .tilb file was created and the lesson bundle was successfully packaged.

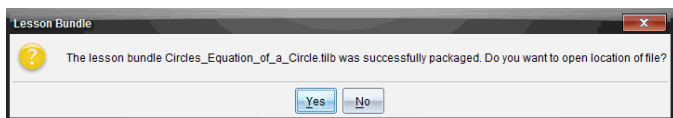

5. Click **Yes** to open the folder where the lesson package is stored. Click **No** to close the dialog box.

Packaging a Lesson in the Contents Workspace

1. In **ComputerContent**, navigate to the folder that contains the lesson bundle you want to package.
2. Click the lesson bundle in the Content pane. The Lesson Bundle details are displayed in the Preview pane.
3. Use one of the following methods to create the package:
 - From the Preview pane, click ► in the Files dialog box, and then click **Package Lesson Bundle**.
 - From the Content pane, right-click the lesson bundle name, and then click **Lesson Bundles > Package Lesson Bundle**.

The Lesson Bundle dialog box opens confirming that the lesson bundle was created.

4. Click **Yes** to open the folder where the lesson package is stored. Click **No** to close the dialog box.

Emailing a Lesson Bundle

After a lesson bundle is packaged, you can email the .tilb file to other teachers or students. To attach the lesson bundle to an email:

1. In your email client, select the option needed to attach a file, and then navigate to the .tilb folder.
2. Make sure you open the folder and select the .tilb file to attach to the email. You cannot email the .tilb folder.

Sending Lesson Bundles to Connected Handhelds

Note: This option is not available in TI-Nspire™ Navigator™ NC Teacher Software.

1. Complete one of the following actions to select a lesson bundle:
 - In the Documents Workspace, open the Content Explorer, and then select the lesson bundle you want to send.
 - In the Content Workspace, navigate to the lesson you want to send in the Content pane.
2. Drag the lesson bundle file to a connected handheld. You can also copy the lesson bundle, and then paste it to a connected handheld.

The lesson bundle is transferred to the handheld as a folder with the same name. Only .tns files are transferred to the handheld.

Capturing Screens

Screen Capture enables you to:

- **Capture Page**
 - Capture the active page in a TI-Nspire™ document from the software or from the TI-SmartView™ emulator as an image.
 - Save captured images as .jpg, .gif, .png, or .tif files, which can be inserted into TI-Nspire™ applications that allow images.
 - Copy and paste images into another application such as Microsoft® Word.
- **Capture Selected Handheld**
 - Capture the current screen on a connected handheld as an image.
 - Save captured images as .jpg, .gif, .png, or .tif files, which can be inserted into TI-Nspire™ applications that allow images.
 - Copy and paste images into another application such as Microsoft® Word.
- **Capture Images in Handheld Mode**
 - In the Documents Workspace, use the DragScreen feature to capture the emulator screen or side screen when the TI-SmartView™ Emulator is active.
 - Teachers can use this feature to drag and paste an image to presentation tools such as SMART® Notebook, Promethean's Flipchart, and Microsoft® Office applications including Word and PowerPoint®.

Accessing Screen Capture

The Screen Capture tool is available from all workspaces. To access Screen Capture:

- ▶ From the menu bar, click **Tools > Screen Capture**.
- ▶ From the toolbar, click  .

Using Capture Page

Use the Capture Page option to capture an image of an active page in a TI-Nspire™ document. You can save images in the following file formats: .jpg, .gif, .png, and .tif. Saved images can be inserted into TI-Nspire™ applications that allow images. The image is also copied to the Clipboard and can be pasted into other applications such as Microsoft® Word or PowerPoint.

Capturing a Page

Complete the following steps to capture an image of an active page.

1. In the Documents Workspace, open a document and navigate to the page you want to capture to make it active.
2. Click , and then click **Capture Page**.

The image of the active page is copied to the Clipboard and to the Screen

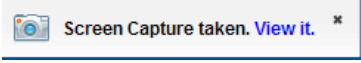
Capture window. The  dialog box opens in the lower right corner of your desktop when the screen capture is complete.

3. Click **View it**.

The Screen Capture window opens.

You can also click **Window > Screen Capture Window** to open the Screen Capture window.

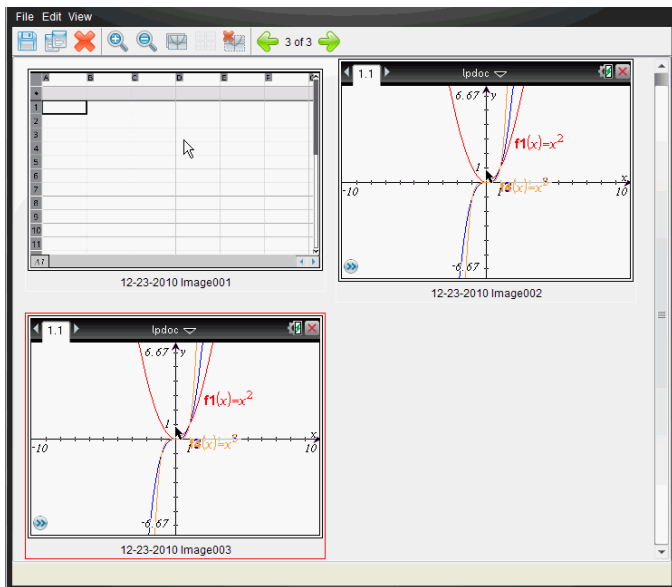

4. To capture additional pages, move to another page in the current document or open a new document to select a page.

As you capture additional pages, the images are copied to the Screen Capture window, which holds multiple images. The last page captured replaces the contents of the Clipboard.

Using Capture Selected Handheld

Use the Capture Selected Handheld option to capture the active screen on a connected handheld.

1. On a connected handheld, navigate to the menu or to a page in a document you want to capture.
2. In the software, select the connected handheld:
 - In the Content Workspace, select the handheld from the list of Connected Handhelds in the Resources pane.
 - In the Documents Workspace, open Content Explorer from the Documents Toolbox, and then select the handheld from the list of Connected Handhelds.
 - In the Class Workspace, select a logged in student.

3. Click , and then click **Capture Selected Handheld**.

–or–

Click , and then click **Capture Selected Handheld**.

The screen is copied to the Clipboard and to the TI-Nspire™ Screen

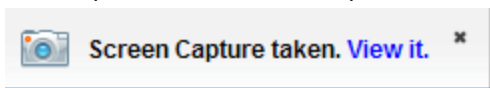

Capture window. The dialog box opens in the lower right corner of your desktop when the screen capture is complete.

4. Click **View it**.

The Screen Capture window opens.

You can capture additional screens from an open document on a connected handheld or open another document on a connected handheld to capture screens from that document.

As you capture additional screens, the images are copied to the Screen Capture window, which holds multiple images. The last screen captured replaces the contents of the Clipboard.

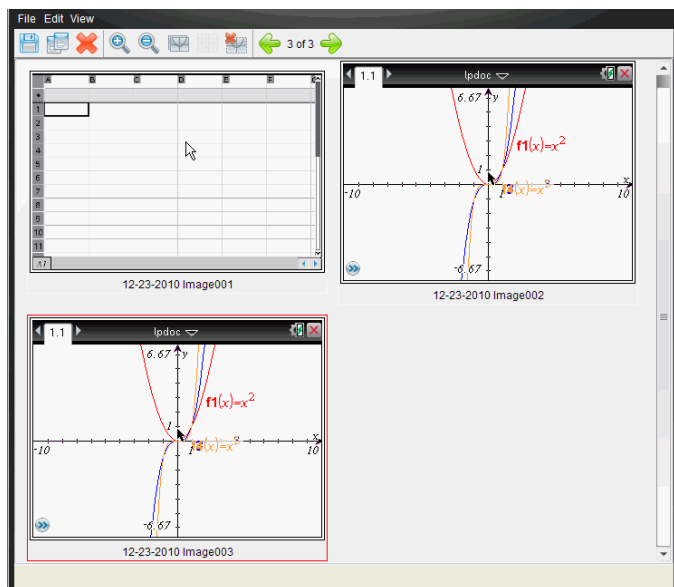

Viewing Captured Screens

When you capture a page or screen, it is copied to the Screen Capture window.



Zooming the View of Captured Screens

In the Screen Capture window, use the zoom in and zoom out options to increase or decrease the size of the captured screens.

- ▶ From the toolbar, click  to increase the size of the screens in the view. You can also click **View > Zoom In** from the menu.
- ▶ From the toolbar, click  to decrease the size of the screens in the view. You can also click **View > Zoom Out** from the menu.

Saving Captured Pages and Screens

You can save captured pages and screens captured as images for use in other TI-Nspire™ documents that allow images or for use in other applications such as Microsoft® Word. You can save one image at a time, select multiple images to save, or save all captured images.

Saving Selected Screens

1. In the Screen Capture window, select the screen image you want to save.
2. Click **File > Save Selected Screen(s)**.

Note: From the Screen Capture window, you can also click .

The Save as dialog box opens.

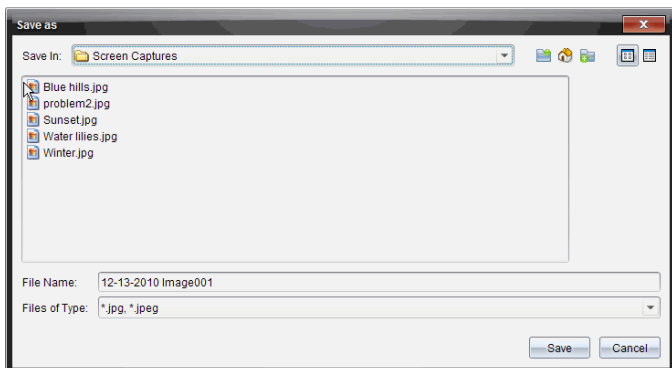

3. Navigate to the folder on your computer where you want to save the file.
4. Type a name for the file.

Note: The default file name is *MM-DD-YYYY Image ###*.

5. Select the file type for the image file. The default format is .jpg. Click ▼ to select another format: .gif, .tif, or .png.
6. Click **Save**.

The file is saved in the designated folder.

Saving Multiple Screens

1. In the Screen Capture window, select the screens you want to save.

To select multiple consecutive screens, click the first image, and then hold down the **Shift** key and click the additional images. To select screens in random order, press **Ctrl** (Mac®: ⌘) and click each image you want to save.

2. Click  or select **File > Save Selected Screen(s)**. To save all captured screens, select **File > Save All Screens**.

Note: The "Save All Screens" option is not available when using Capture Class.

The Save as dialog box opens.

3. In the Save In field, navigate to the folder where you want to save the images.
4. In the File Name field, type a new folder name. The default folder name is *MM-DD-YYYY Image*, where *MM-DD-YYYY* is the current date.
5. Select the file type for the image files. The default format is .jpg. Click ▼ to select another format: .gif, .tif, or .png.
6. Click **Save**.

The images are saved in the specified folder with system-assigned names reflecting the current date and a sequence number. For example, *MM-DD-YYYY Image 001.jpg*, *MM-DD-YYYY Image 002.jpg* and so on.

Copying and Pasting a Screen

You can select a captured screen and copy it to the Clipboard for inclusion into other documents or applications. You can also print copied screens. Copied screens are captured at 100% zoom level, and they are copied in the order of selection.

Copying a Screen

1. Select the screen to copy.
2. Click  or **Edit > Copy**.

The selected screen is copied to the Clipboard.

Pasting a Screen

Depending on the application you are pasting to, click **Edit > Paste**.

Note: You can also drag a screen capture to another application. This functions as a copy and paste.

Capturing Images in Handheld Mode

In the Documents Workspace, use the DragScreen feature to capture the emulator screen or side screen when the TI-SmartView™ Emulator is active.

Teachers can use this feature to drag and paste an image to presentation tools such as SMART® Notebook, Promethean's Flipchart, and Microsoft® Office applications including Word and PowerPoint®.

Capturing Images Using the DragScreen Feature

Complete the following steps to capture an image and copy it to a third-party application.

1. From the Documents Workspace, click , which is located in the Documents Toolbox.

The TI-SmartView™ Emulator opens.

- If the display selected is **Handheld + SideScreen**, the current document is shown in the emulator and in the side screen.
- If the display selected is **Keypad + SideScreen**, the current document is shown in the side screen.

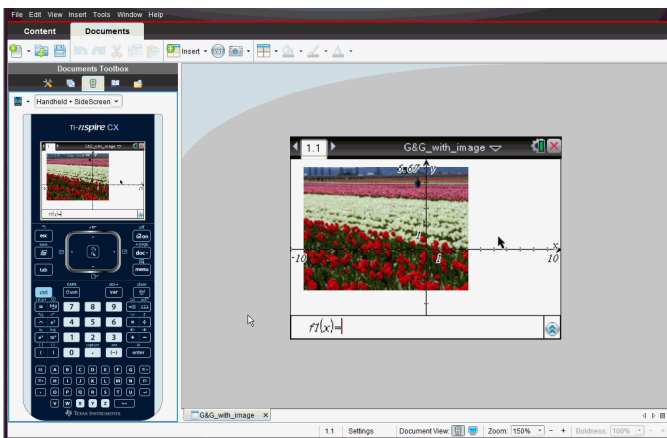

2. To start the screen capture, click the area above the emulator screen or above the keypad. In the **Handheld + Sidescreen** display, you can also click the area around the emulator screen.

Do not release the mouse button. If the cursor is active or if you click inside the emulator window, the screen capture is not started.

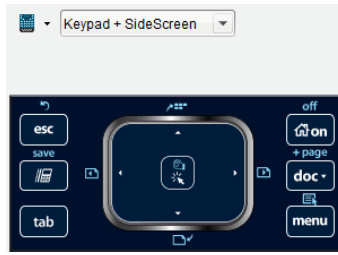
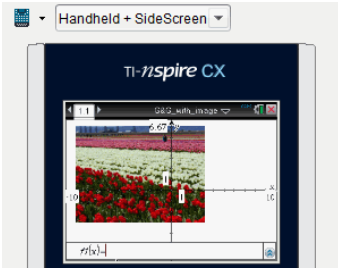

In Handheld + SideScreen view, click the area above the emulator, click the area around the emulator, or click the border of the emulator screen to start the screen capture.

In Keypad + SideScreen view, click the area above the keypad to start the screen capture.

3. Without releasing the mouse, drag the image.

A ghost image of the captured screen opens. The ghost image remains visible until you release the mouse button.



The  in the corner of the ghost image indicates you cannot paste the image in that location.

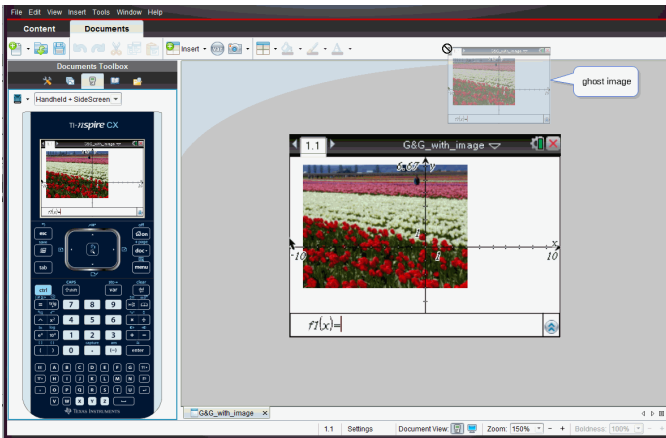

4. Drag the image to an open third-party application. When the image is on

top of the third-party application, the  indicates you can drop the image.

5. Release the mouse button to drop the image into the selected application. The image is also copied to the Clipboard and to the TI-Nspire™ Screen Capture window.

To view captured images in the Screen Capture window, click **Window > Screen Capture Window**.

You can capture additional screens as needed. As you capture additional screens, the images are copied to the Screen Capture window, which holds multiple images. The last screen captured replaces the contents of the Clipboard.

Working with Images

Images can be used in TI-Nspire™ applications for reference, assessment, and instructional purposes. You can add images to the following TI-Nspire™ applications:

- Graphs & Geometry
- Data & Statistics
- Notes
- Question, including Quick Poll

In the Graphs & Geometry and Data & Statistics applications, images are set in the background behind the axis and other objects. In the Notes and Question applications, the image is set at the cursor location inline with the text (in the foreground).

You can insert the following image file types: .jpg, .png, or .bmp.

Note: The transparency feature of a .png file type is not supported. Transparent backgrounds are displayed as white.

Working with Images in the Software

When working in the TI-Nspire™ software, you can insert, copy, move, and delete images.

Inserting Images

In the Notes and Question applications, and in Quick Poll, you can insert more than one image on a page. You can only insert one image on a page in the Graphs & Geometry and Data & Statistics applications.

1. Open the document where you want to add an image.
2. Click **Insert > Image**.

The Insert Image dialog box opens.

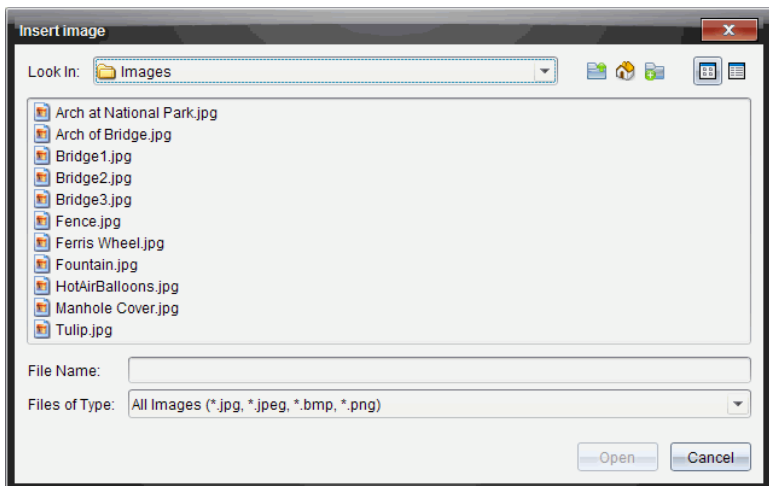



3. Navigate to the folder where the image is located and select the image.
4. Click **Open**.
 - In the Graphs & Geometry and Data & Statistics applications, the image is inserted in the background behind the axis.
 - In Notes, Question, and Quick Poll, the image is inserted at the cursor location. You can type text above or below the image, and you can move the image up or down on the page.

Note: You can also insert images by copying an image to the Clipboard and pasting it into the application.

Moving Images

In applications such as Notes and Question where the image is set at the cursor location, you can reposition the image by moving the image to a new line or blank space, or by placing the image within a line of text. In the Graphs & Geometry and Data & Statistics applications, images can be moved to any position on the page.

1. Select the image.
 - In the Notes and Question applications, click the image to select it.
 - In the Graphs & Geometry and Data & Statistics applications, right-click the image, and then click **Select > Image**.
2. Click the selected image and hold the mouse button.

- If an image is in the foreground, the cursor changes to .
 - If an image is in the background, the cursor changes to .
3. Drag the image to the new location and release the mouse button to place the image.

If an image is in the foreground, the cursor changes to  when you hover your mouse pointer over a location where there is a new line or space. Images in the background can be moved and placed anywhere on the page.

Resizing Images

To retain the aspect ratio of an image, resize by grabbing the image at one of the four corners.

1. Select the image.
 - In the Notes and Question applications, click the image to select it.
 - In the Graphs & Geometry and Data & Statistics applications, right-click the image, and then click **Select > Image**.

2. Move the cursor to one of the corners of the image.

The cursor changes to  (a four-sided directional arrow).

Note: If you drag the cursor to an edge of the image, the cursor changes to  (a two-sided directional arrow). If you drag an image from one of its edges to resize it, the image becomes distorted.

3. Click the corner or edge of the image.

The  tool is enabled.

4. Drag in to make the image smaller or drag out to make the image larger.
5. Release the mouse when the image size is correct.

Deleting Images

To delete an image from an open document, complete the following steps.

1. Select the image.
 - If an image is in the foreground, click the image to select it.
 - If an image is in the background, right-click the image, and then click **Select > Image**.

2. Press **Delete**.

The image is removed.

Using Question in the Teacher Software

The Question application in the Teacher Software allows you to author multiple choice, open response, equation, expression, coordinate points, lists, image, and chemistry questions.

Although students cannot author questions, they can open documents containing questions, answer these questions, and, in Self-Check mode, check their work.

The Question application is located on the Insert menu in the Documents Workspace.

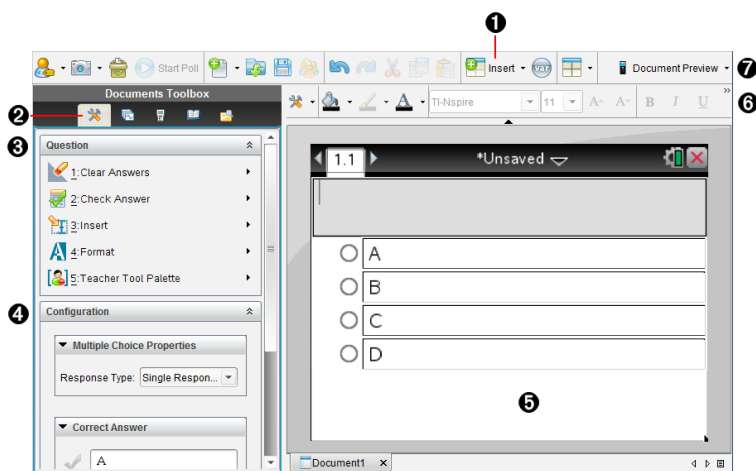





- 1 Insert menu.** Click **Insert** and select **Question** to add a question, or select **Image** to add an image to a question.
- 2 Document Tools.** Click this icon to open the toolbox pane.
- 3 Question tool.** Provides a menu of tools available for working with the Question application.
- 4 Configuration tool.** Allows you to set certain properties for each question you insert.
- 5 Question area.** This is where you type questions and view student responses.
- 6 Formatting toolbar.** Allows you to apply formatting to text.

- 7 Document Preview.** View the document in Handheld or Computer mode. The preview changes, but the page size does not. For more information on Document Preview, see *Working with TI-Nspire™ Documents*.



Understanding the Question Tools

When you add a question, the Question application opens. If necessary, click Document Tools  to open the tools menu.

Note: The Teacher Tool Palette is not available to students.

Tool name		Tool function
	Clear Answers	Lets teachers or students clear the answers in the current question or in the document.
	Check Answer	If you select Self-Check as the document type in the Question Properties dialog box, students can check their answer to the question.
	Insert	Lets teachers or students insert an expression box or chemical equation box into the question or answer.
	Format	Lets teachers or students format the selected text as subscript or superscript. (The chemical equation box uses its own formatting tool, so this Format tool does not work in the chemical equation box.)
	Teacher Tool Palette	Lets you add copyright information and set the document type as Self-Check or Exam.

Using the Insert Menu

The Insert menu in the Document Tools lets you add math expression boxes  and chemical equation boxes  to the Question area, Suggested Response area, or Correct Answer area of some question types. When you are

in question types that allow math expressions or chemical equations, place your cursor where you want to insert the box, and then follow these steps.

1. Open the Question tool.
2. Click **Insert > Expression Box** or **Chem Box**.
The software inserts a blank box where your cursor is positioned.
3. Type the desired math expression or chemical equation, and then click outside of the box to continue typing text.

Using the Teacher Tool Palette

The Teacher Tool Palette allows you to add copyright information and set the document type as Self-Check or Exam.

Adding Copyright Information

Use the Question Properties dialog box to add copyright information to the current question.

1. Click the **Teacher Tool Palette** icon  > **Question Properties**.
The Question Properties dialog box opens.

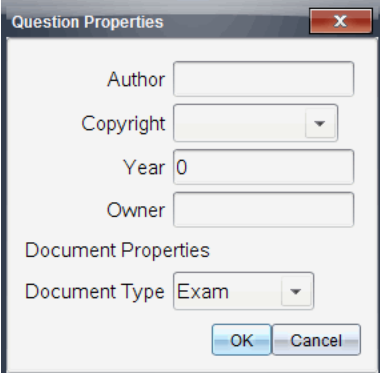

The screenshot shows a dialog box titled "Question Properties" with a close button (X) in the top right corner. It contains the following fields and controls:

- Author: A text input field.
- Copyright: A dropdown menu.
- Year: A text input field containing the number "0".
- Owner: A text input field.
- Document Properties: A section header.
- Document Type: A dropdown menu showing "Exam".
- At the bottom, there are "OK" and "Cancel" buttons.

2. Type the author's name and move to the **Copyright** field.
Note: TI-Nspire™ software allows you to use questions from more than one author in the same document. Therefore, the information that you enter about the author and copyright is not global. You must enter the relevant information for each different question.

3. Select whether the question is public domain or has a copyright assigned to it and move to the **Year** field.
4. Type the year the question was copyrighted and move to the **Owner** field. If you are copyrighting a new question, type the current year (example: 2012).
5. Type the name of the person or entity that owns the copyright.
6. Click **OK**.

Setting Self-Check and Exam Document Types

When you define a document as Self-Check or Exam, all of the questions in that document will be either Self-Check or Exam.

- When you define the document type as Self-Check, students can check the answers against the answers provided by the teacher.
- In Exam mode, when you enter a suggested response to a question, students cannot check the answers. You can use Exam mode to automatically grade student responses.

1. Click the **Teacher Tool Palette** icon  > **Question Properties**.
2. In the Document Type field, click **Exam** or **Self-Check**.
3. Click **OK**.

Understanding the Configuration Tool

The Configuration tool allows you to set properties specific to each question type you insert. Properties include the response type, the number of responses (if applicable), the correct answer, and other options.

For example, you can specify the correct answer to a question, and set the scale, axes, and grid on a graph. You can add a 2D math expression on the question types that contain a Correct Answer field.

Each question type has a unique set of options. The options are explained for each question type in the *Adding Questions* section.

The configuration settings are retained when you copy and paste a question from one document to another.

Adding Configuration Options

1. Click the down arrow on the Configuration bar in the Documents Toolbox to open the Configuration tool.

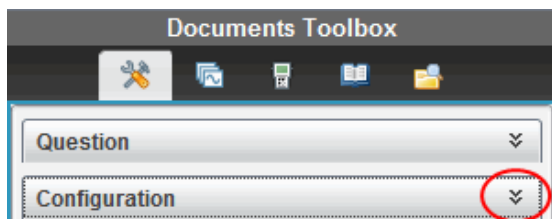

2. Click the down arrow next to the choices you want to edit, and type the applicable text.

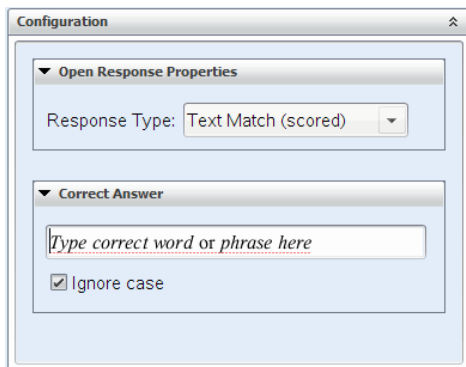

3. Close the Configuration panel. The options you chose are saved when you save the document.

Formatting Text and Objects

Use the text formatting tools to format text in sections of questions that allow text input.

The formatting toolbar also contains the Document Tools  icon to provide easy access to the Question and Configuration tools.

For more information on formatting text and objects, see *Working with TI-Nspire™ Documents*.

Adding Images to Questions

You can add images to the Question Text Area of most questions. On some question types, you can add an image in the Student Answer or Suggested Response Area of a question.

Adding images provides a visual aid to help explain the context of the question, or as a background on a graph.

Choose the image from a set of images on your computer, or copy and paste an image from a different application into the Question Text Area. For more information, see *Working with Images*.

Image Types Available

The following file types can be used in the Question application:

- .jpg
- .jpeg
- .bmp
- .png

Note: The transparency feature of .png is not supported. Any transparent .png backgrounds will appear as white.

Adding Images Using the Insert Command

1. Click **Insert > Image**.

The Insert Image dialog box opens.

2. Navigate to the location of the image and select it.

3. Click **Open**.

The image appears in the question.

Adding Images Using the Clipboard

To copy an image to the Clipboard from a TI-Nspire™ document, image file, or another program, press **Ctrl + C** (Mac®: **⌘ + C**).

To paste the image into the question, press **Ctrl + V** (Mac®: **⌘ + V**).

Adding Questions

You can add the following types of questions:

- Multiple Choice

- Custom
- ABCD
- True/False
- Yes/No
- Always/Sometimes/Never
- Agree/Disagree
- Strongly Agree...Strongly Disagree
- Open response
 - Explanation (not auto-graded)
 - Text Match (auto-graded)
- Equations and Expressions
 - $y=$
 - $f(x)=$
 - Expression
- Coordinate Points and Lists
 - (x,y) numerical input
 - Drop Point(s)
 - List(s)
- Image
 - Label
 - Point on
- Chemistry

When you select a question type, a brief explanation of the question is displayed at the bottom of the Choose Question Type dialog box.

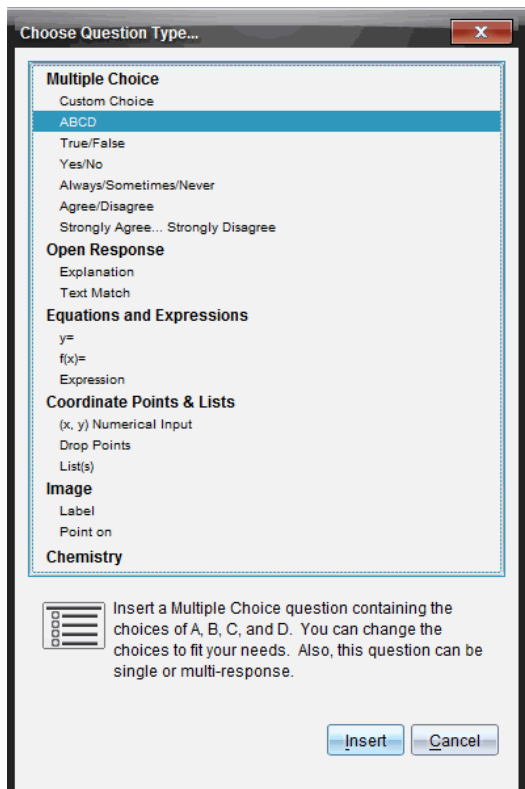

When you open a question template, the cursor is in the Question text area.

Adding a Multiple Choice Question

This example shows how to add a custom multiple choice question. A custom multiple choice question allows you to specify answers your students can select. You can then select one or more responses as correct to help you when grading or to help students check questions that are in Self-Check mode.

Which of the following are roots of $x^2 = 9$?
Mark all that apply.

- | | |
|--------------------------|-----|
| <input type="checkbox"/> | 9 |
| <input type="checkbox"/> | 3 |
| <input type="checkbox"/> | -3 |
| <input type="checkbox"/> | -9 |
| <input type="checkbox"/> | 3i |
| <input type="checkbox"/> | -3i |

To add a custom multiple-choice question:

1. Click **Insert > Question**.

The Choose Question Type dialog box opens.

2. Click **Custom Choice** under the **Multiple Choice** heading.

3. Click **Insert**.

The Custom Choice template opens with the cursor in the Question text area.

Two response options exist in the template by default.

4. Type the question.

- You can type any combination of text, math expressions, and chemical equations in the Question Area and Suggested Response area.
- You can add an image in the question text area.

5. Press **Enter** to add another question line, or press **Tab** to go to the first Correct Answer button.

6. Type the response options. Add an image, if desired.

7. Press **Enter** to add other response options, and add the response text.

- Press **Delete** to clear or delete a response.
- Press **Backspace** to delete an empty response line.

8. Click the option next to a suggested response, if desired.

Note: In Self-Check mode, the student can check their answer against the suggested response.

- Open the Configuration tool. Choose the response type, and click the option that corresponds to the correct answer.

Adding an Open Response Question

An open response question prompts the student to write a response. An explanation question type allows students to respond without any predefined answers. A text match question type allows the teacher to specify an answer for the student response. Text match questions are automatically graded; open response questions are not automatically graded.

One word that describes two lines that never meet but are in the same plane:
Student: Type response here.

This example shows how to add an explanation question.

- Click **Insert > Question**.
The Choose Question Type dialog box opens.
- Click **Explanation** under **Open Response**.
- Click **Insert**.
The Open Response template opens with the cursor in the Question text area.
- Type the question.
 - You can type any combination of text, math expressions, and chemical equations in the Question Area and Suggested Response area.
 - You can add an image in the question text area.
 - Press **Tab** or use the mouse pointer to navigate between fields.
- Open the Configuration tool. Select the response type as Explanation or Text Match, and type the correct answer.

- The Explanation response type allows students to give answers that closely match your suggested response.
- The Text Match response type requires students to exactly match your suggested response. Select the **Ignore Case** check box if capitalization is not important.
- You can type any combination of text, math expressions, and chemical equations in the Correct Answer area.

Adding an Equation Question

An equation question prompts the student to write an equation in the form of $y=$ or $f(x)=$, or to respond with a number or expression.

This example shows how to add a $y=$ question.

1. Click **Insert > Question**.
The Choose Question Type dialog box opens.
2. Select **y=** under **Equations and Expressions**.
3. Click **Insert**.
The equation template opens with the cursor in the Question text area.
4. Type the question.
 - You can type any combination of text, math expressions, and chemical equations in the Question Area.
 - You can add an image in the question text area.
 - Press **Tab** or use the mouse pointer to navigate between fields.
5. Enter a suggested response, if desired.
6. Press **Enter** to add other response options, and add the response text.

- Press **Delete** to clear or delete a response.
 - Press **Backspace** to delete an empty response line.
7. Open the Configuration tool to set the number of responses, the correct answer, and whether the students should show their work. You can also add a graph that will show in the Question area.

The screenshot shows a 'Configuration' window with two main sections:

- Equation Properties:**
 - Response Type: $y =$
 - Number of responses: 1
 - Include a Graph Preview
 - Prompt Location: Left
 - Allow students to show their work
- Correct Answer:**
 - Accepted response(s): $y = x^2 - 2 \cdot x - 15$
 - Accept equivalent responses as ...
 - [How does this work?](#)

- The number of responses can range from 1 to 5.
- The **Show your work** option includes areas for the students to write their starting point, their steps, and their final answer. The option to show work is disabled if multiple responses are allowed.
- To add a graph in the Question area, check **Include a Graph Preview**. The Question text area splits to show a graph on the right.
- When you are in the graph, the Graphs & Geometry toolbox is available to allow you to add functions.

Note: Only the teacher can edit the graph. Students can only view and zoom the graph.

- Click  to add additional fields for multiple correct answers. For example, you might want to accept both $y=(x+1)(x+2)$ and $y=(x+2)(x+1)$ as correct answers.
- Select whether or not to accept equivalent responses as correct.

- If you *do not* check **Accept equivalent responses as correct**, the student response is marked correct if it is an exact text match to one of the accepted responses you entered.
- If you *do* check **Accept equivalent responses as correct**, the student response is marked correct if it is equivalent to any accepted response you entered. For example, if you typed $x+2$ as the correct answer, and the student submits $2+x$, this response is equivalent to the accepted response and is automatically graded as correct. Spaces, case differences, and extra parentheses are ignored when the software evaluates student answers. For example, $y=2x+1$ is evaluated the same as $Y = 2X + 1$.

Adding an Expression Question

An expression question prompts the student to respond with a number value or an expression.

The dog walker earns \$12 per hour, and she spends \$2 on gas getting to and from her client's house. She walks the dog for 30 minutes each day. Write an expression showing how much money she earns in one day.

Enter expression

1. Click **Insert > Question**.
The Choose Question Type dialog box opens.
2. Click **Expression** under **Equations and Expressions**.
3. Click **Insert**.
The expression template opens with the cursor in the Question text area.
4. Type the question.
 - You can type any combination of text, math expressions, and chemical equations in the Question area.
 - You can add an image in the Question area.

- In the Expression type response, enter a starting expression, if desired. The student sees the starting expression.
- Enter a suggested response, if desired.
 - If you set the response type as Number, the response fields are math boxes and accept only number values such as 1/3.
 - If you set the response type as Expression, the response fields are expression boxes and accept only expression inputs such as 2(3+5).
- Open the Configuration tool to set the response type as Number or Expression, set whether or not the students should show their work, and enter a correct answer. You can also set a tolerance for Number types, or equivalent responses for Expression types.

▼ Expression Properties

Response Type: Expression ▼

Allow students to show their work

▼ Correct Answer

Accepted numerical response:

Tolerance: ±

Accepted expression response(s):

$\frac{12}{2} - 2$ + -

Accept equivalent responses as ...

[How does this work?](#)

- The **Show your work** option includes areas for the students to write their starting point, their steps, and their final answer.
- In the Number type response, enter the accepted numerical response and the tolerance. Student responses are marked correct if they fall within the tolerance interval you specify.
- Specifying a tolerance of zero indicates you are looking for the exact number answer. Not specifying a tolerance is the same as specifying a tolerance of zero.
- Student answers are considered correct if they are numerically equivalent to the correct answer. Spaces, case differences, and extra

parentheses are ignored when the software evaluates student answers.

- In the Expression type response, you can add additional fields (up to 10) for multiple correct answers.
- In the Expression type response, click  to open the Templates and Symbols catalog that allows you to enter 2D math expressions.
- In the Expression type response, you can select whether or not to accept equivalent responses as correct.
 - If you *do not* check **Accept equivalent responses as correct**, the student response is marked correct if it is an exact text match to one of the accepted responses you entered.
 - If you *do* check **Accept equivalent responses as correct**, the student response is marked correct if it is equivalent to any accepted response you entered. For example, if you typed $x+2$ as the correct answer, and the student submits $2+x$, this response is equivalent to the accepted response and is automatically graded as correct. Spaces, case differences, and extra parentheses are ignored when the software evaluates student answers. For example, $x+2$ is evaluated the same as $X + 2$.

Important: Students can enter the starting expression you supply and have this response automatically graded as correct. For example, if you ask students to factor $x^2-7x+12$ and stipulate the correct answer is $(x-3)(x-4)$, the student can submit a response of $x^2-7x+12$. This response is automatically graded as correct because it is equivalent to the accepted answer. You must manually mark this student response as incorrect in either the Review or Portfolio Workspaces. See the chapters for those workspaces for more information on marking and grading responses.

Adding an (x,y) Numerical Input Question

An (x,y) numerical input question prompts the student to respond with a coordinate.

Write the ordered pair for each given point in order: J, N, P

<input type="text"/>	<input type="text"/>
<input type="text"/>	<input type="text"/>
<input type="text"/>	<input type="text"/>

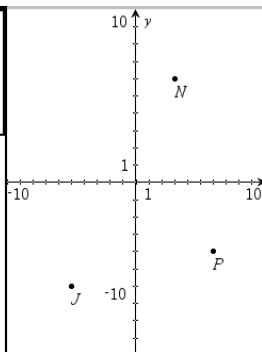

1. Click **Insert > Question**.

The Choose Question Type dialog box opens.

2. Click **(x,y) Numerical Input** under **Coordinate Points & Lists**.

3. Click **Insert**.

The template opens with the cursor in the Question text area.

4. Type the question.

- You can type any combination of text, math expressions, and chemical equations in the Question area.
- You can add an image in the Question area.
- Press **Tab** or use the mouse pointer to navigate between fields.

5. Enter a suggested response, if desired.

- The response fields are expression boxes and accept only expression inputs.

6. Press **Enter** to add other response options (up to five), and add the response text.

- Press **Delete** to clear or delete a response.
- Press **Backspace** to delete an empty response line.

7. Open the Configuration tool to set the number of points, add a graph preview, enter a correct answer, and set equivalent responses as correct.

▼ Coordinate Point Properties

Number of Points: 3

Include a Graph Preview

Prompt Location: Left

▼ Correct Answer



Acceptable Answer(s):

(-5 ,
 -6)

(3 ,
 6)

(6 ,
 -4)

Accept equivalent responses as ...

- The number of points can range from 1 to 5.
 - Click  to add additional fields for multiple correct answers. You can type any combination of text, math expressions, and chemical equations in the correct answer fields.
 - Click  to open the Templates and Symbols catalog that allows you to enter 2D math expressions.
 - To add a graph in the Question area, select **Include a Graph Preview**. The Question text area splits to show a graph on the right and the student prompt area on the left. To change the location of the graph, click the down arrow next to **Prompt Location** and choose the desired location for the graph in the student prompt area.
 - When you are in the graph, the Graphs & Geometry tools are available to allow you to add functions.
- Note:** Only the teacher can edit the graph. Students can only view and zoom the graph.
- Select whether or not to accept equivalent responses as correct.
 - If you *do not* check **Accept equivalent responses as correct**, the student response is marked correct if it is an exact text match to one of the accepted responses you entered.

- If you *do* check **Accept equivalent responses as correct**, the student response is marked correct if it is equivalent to any accepted response you entered. For example, if you typed $(-0.5, .75)$ as the correct answer, and the student submits $(-.5, .75)$ or $(-1/2, 3/4)$, and so forth, the student response is equivalent to the accepted response and is automatically graded as correct.

Adding a Drop Points Question

A drop points question inserts a graph and prompts the student to drop points on the graph in response to your question.

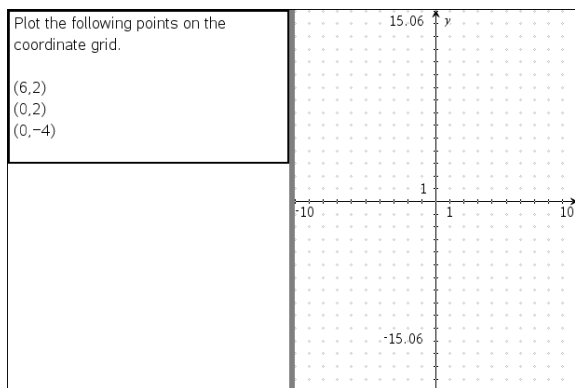

1. Click **Insert > Question**.

The Choose Question Type dialog box opens.

2. Select **Drop Points** under **Coordinate Points & Lists**.

3. Click **Insert**.

The drop points template opens with the cursor in the Question text area.



The graph is in the Student answer area.

- When you are in the graph, the Graphs & Geometry tools are available to allow you to add functions.

Note: Only the teacher can edit the graph. Students can only view, zoom, or place points on the graph.

4. Type the question.

- You can type any combination of text, math expressions, and chemical equations in the Question area.

- You can add an image in the Question Area.
 - Press **Tab** or use the mouse pointer to navigate between fields.
5. Open the Configuration tool to set the number of points, hide or show coordinates, and enter a correct answer.
- The number of points can range from 1 to 5.
 - Showing coordinates is turned off by default. Select the check box to display coordinate labels on the graph.
 - Click  to add additional fields for multiple correct answers. You can type any combination of text, math expressions, and chemical equations in the correct answer fields.
 - Click  to open the Templates and Symbols catalog that allows you to enter 2D math expressions.

Adding a Lists Question

A Lists question inserts a list and prompts students to enter data in the lists in response to your question.

Submit the following data – distance in miles between home and work (distance) and the travel time in minutes (time)	A distance	B time
	1	
2		
3		
4		
5		
6		
7		
8		
9		
10		
11		
12		
13		
14		
15		

1. Click **Insert > Question**.
The Choose Question Type dialog box opens.
2. Select **List(s)** under the **Coordinate Points & Lists** question from the Choose Question Type dialog box.
3. Click **Insert**.
The List template opens with the cursor in the Question text area.

4. Type the question.
 - You can add columns or rows, change the name of the lists, and input data in the lists, using the same functions allowed in the Lists & Spreadsheet application.
5. Enter initial data in the lists, if desired.
6. Open the Configuration tool to set the number of lists for the student responses.
 - The number of lists can range from 1 to 5.
 - Lists must have names. The default names are **List1**, **List2**, and so forth.

Adding an Image: Label Question

An Image: Label question inserts an image. You can add blank fields to the image and have students fill in the blanks in response to your question.

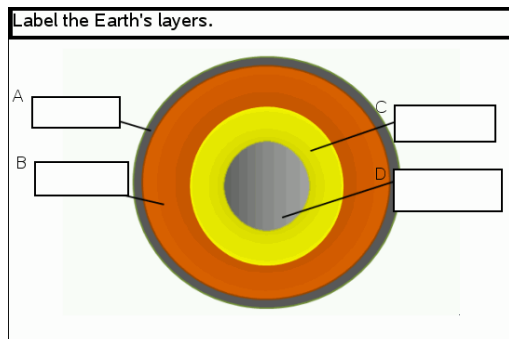

1. Click **Insert > Question**.

The Choose Question Type dialog box opens.
2. Select **Label** under **Image**.
3. Click **Insert**.

The Image: Label template opens with a blank background and one label. This is where the image for the question is inserted.
4. Type the question.
 - You can type any combination of text, math expressions, and chemical equations in the Question area.
 - Press **Tab** or use the mouse pointer to navigate between fields.

5. Insert an image in the bottom portion of the question template.
6. Open the Configuration tool to set the number of responses and to enter answers for each label.

The screenshot shows a 'Configuration' window with two main sections. The first section, 'Image Analysis Question Properties', contains a 'Number of Responses' dropdown menu set to '4'. The second section, 'Answers', lists four labels: 'A crust', 'B mantle', 'C outer core', and 'D inner core'. Each label has a small icon to its right. At the bottom of the 'Answers' section, there is a checked checkbox labeled 'Ignore Case'.

- The number of responses determines the number of labels on the image. Each new response gives the label a unique identifier, such as A, B, C, and so forth. Drag the labels to the desired location on the image.
Note: If you set more than 26 responses, the labels are identified with numbers, starting with 1. You can insert a maximum of 35 labels.
 - In the answers area, click  to open the Templates and Symbols catalog that allows you to enter 2D math expressions.
 - If the label text is too large to fit in the default label size, grab and drag the borders of the label to resize it.
7. Type a suggested response in the labels, if desired. Select the **Ignore case** check box if capitalization is not important.
 - You can type any combination of text, math expressions, and chemical equations in the response area.
 - As you type the suggested response, a ghosted image of your answer appears in the respective label on the image. If the suggested response is too large for the default label size, grab and drag the borders of the label to resize it.

Adding an Image: Point on Question

An Image: Point on question inserts an image. Add check boxes to the image and have students place a check mark in the correct boxes in response to your question.

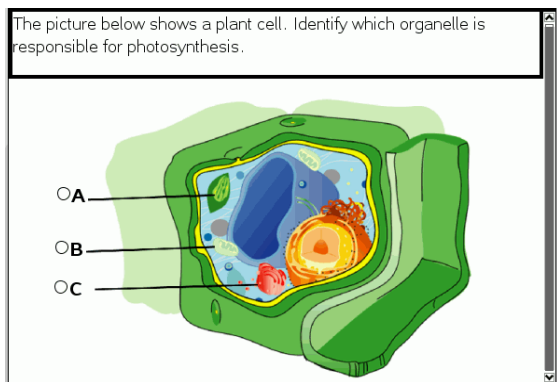

1. Click **Insert > Question**.

The Choose Question Type dialog box opens.

2. Select **Point on** under **Image**.

3. Click **Insert**.

The Image: Point on template opens with a blank background and one point. This is where the image for the question is inserted.

4. Type the question.

- You can type any combination of text, math expressions, and chemical equations in the Question area.
- Press **Tab** or use the mouse pointer to navigate between fields.

5. Open the Configuration tool to set the response type, number of responses, and correct answer.

- The Response Type makes the point a circle for Single Response and changes to a square for Multiple Responses to indicate students can select more than one box.
- The number of responses determines the number of points on the image. Each new response gives the point a unique identifier, such as A, B, C, and so forth. Drag the points to the desired location on the image.

Note: If you set more than 26 responses, the points are identified with numbers, starting with 1. You can insert a maximum of 35 points.

6. Click a point or points as a suggested response, if desired.

Adding a Chemistry Question

When you add a Chemistry question, students respond with a chemical formula or equation.

Balance the following equation: ___ N ₂ + ___ H ₂ → ___ NH ₃
Student: enter chemical notation here.

1. Click **Insert > Question**.

The Choose Question Type dialog box opens.

2. Click **Chemistry**.

3. Click **Insert**.

The Chemistry template opens with the cursor in the Question text area.

4. Type the question.

- You can type any combination of text, math expressions, and chemical equations in the Question area.
- You can add an image in the Question area.

5. Enter a suggested response, if desired.

6. Open the Configuration tool to enter a correct answer.



Click  to add additional fields for multiple correct answers. You should enter all possible answers. The software does not evaluate equivalency for Chemistry answers.





Responding to Questions

The teacher may send you several different question types. This section shows you how to answer the different question types.

Understanding the Question Toolbar

When you open a document with a question, a toolbar is available with four options. Access the toolbar using the following method.

- ▶ In the Documents Toolbox, click .
Handheld: press .

Tool name		Tool function
	Clear Answers	Lets you clear the answers in the current question or in the document.
	Check Answer	If the teacher enabled Self-Check mode for the question, click here to view the correct answer.
	Insert	Lets you insert a math expression box or chemical equation box in your answer.
	Format	Click this tool to format the selected text in your answer as subscript or superscript. (The chemical equation box uses its own formatting tool, so this Format tool does not work in the chemical equation box.)

Types of Questions

There are several types of questions you may be asked. There may be variations in a type, but how you answer the question is basically the same for each type.

- Multiple Choice
 - Custom

- ABCD
- True/False
- Yes/No
- Always/Sometimes/Never
- Agree/Disagree
- Strongly Agree...Strongly Disagree
- Open response
 - Explanation (not auto-graded)
 - Text Match (auto-graded)
- Equations and Expressions
 - $y=$
 - $f(x)=$
 - Expression
- Coordinate Points and Lists
 - (x,y) numerical input
 - Drop Point(s)
 - List(s)
- Image
 - Label
 - Point on
- Chemistry

Responding to Quick Poll Questions

When teachers send quick polls during class, the question opens as a new document on top of any document you may currently have open. You can access other applications to perform calculations, and check or clear answers before submitting your answer to the question or quick poll.

Note: On TI-Nspire™ CX or TI-Nspire™ CX CAS handhelds, questions appear in color if the teacher applied color when writing the question. Although you can see color in the questions you receive, you cannot add color to the responses you submit. If you are using a TI-Nspire™ or TI-Nspire™ CAS handheld, questions are shown in black and white.

Accessing Other Applications

If the teacher gives permission, the Quick Poll tool allows you to temporarily exit the question to perform calculations or access other documents to determine the answer to the question. For example, you can access the Scratchpad to perform a calculation, or you can access the Lists & Spreadsheet application and copy data from there to a List question type. In a List question, you can link to variables from the Vernier DataQuest™ or Lists & Spreadsheet applications.

To access other applications while in the Quick Poll screen:

1. Open a new document.

Handheld: Press  to open the **Home** screen.

2. Choose an application.

Handheld: To return to the Quick Poll without accessing any documents, choose **C: Quick Poll**.

3. When you are finished, click the Quick Poll icon.

When you respond to a poll, your response is immediately sent to the teacher's computer and teachers can track student responses in real time.

Showing Your Work

The teacher may request you to show work for your response. If so, the response area has sections for you to write your starting point, your steps, and the final answer.

Responding to Different Question Types

- ▶ For Multiple Choice questions, press **Tab** to navigate to a response. Press **Enter** to mark a response.
- ▶ For Open Response questions, type a response.
- ▶ For Equation questions, type a response. If a graph is included in a question, the graph updates when you press **Enter**. Any functions entered show up on the graph, and the cursor remains in the answer box. You cannot manipulate the graph itself.
- ▶ For Expression questions, type a response. If the response type is Number, your response must be in the form of a number. If the response type is Expression, your response must be in the form of an expression. For example, $x+1$.

- ▶ For Coordinate Points: (x,y) questions, type an answer in the x-field box, and press **Tab** to move to the y-field box. Type an answer.
If a graph is included with the question, the graph is updated when you enter a function and press **Enter**.
You can access the Window and Zoom functions while you are working on the graph.
- ▶ For Coordinate Points: Drop Points questions, press **Tab** to move the cursor to a point on the graph. Press **Enter** to drop a point at that location.
To delete a point, press **Ctrl + Z** to undo the action.
- ▶ For Lists questions, press **Tab** if necessary to move the cursor to the first cell of the list. Type an answer, and press **Tab** to move to the next cell. Type an answer.
To link a column to an existing variable, select the column and then click **var**. Click **Link To**, and then click the variable you want to link to.
The behavior in a Lists question closely matches the behavior of the Lists & Spreadsheet application, with the following exceptions. In a Lists question, you cannot:
 - Add, insert, or delete columns.
 - Change the header row.
 - Enter formulas.
 - Switch to Table.
 - Create plots.
- ▶ For Chemistry questions, type a response.
- ▶ For Image: Label questions, press **Tab** to move the cursor to a label on the image. Type a response in the label field.
- ▶ For Image: Point on questions, press **Tab** to move the cursor to a point on the image. Press **Enter** to mark a response.

Checking Answers

If the teacher enables self-check on the question, the Check Answer option is available.

1. Click .

Handheld: Press .

2. Click **Check Answer**.

Clearing Answers

After you answer a quick poll, you may decide you want to change the answer before you submit it.

- ▶ Click **Menu > Clear Answers > Current Question** or **Document**.
 - **Current Question** clears answers for the active question.
 - **Document** clears answers for all questions contained in the active document.

—or—

If you answered the question, you still have time to clear the answer before you submit it to your teacher.

- ▶ Click **Clear Answer** to clear your answer and try again.

Handheld: Press and choose **Clear Answer**.

Submitting Responses

To send a final answer to the teacher:

- ▶ Click **Submit Response**.

Handheld: Press and choose **Submit**.

The response is sent to the teacher and the last screen you used is displayed.

Your response appears on the teacher's computer. Your teacher may have set the poll to allow you to submit more than one answer. If so, you can continue to respond to the poll and submit answers until the teacher stops the poll.

Calculator Application

The Calculator application lets you:

- Enter and evaluate math expressions
- Define variables, functions, and programs that become available to any TI-Nspire™ application—such as the Graphs application—residing in the same problem.
- Define library objects, such as variables, functions, and programs, which are accessible from any problem of any document. For information on creating library objects, see *Libraries*.

Adding a Calculator Page

- ▶ To start a new document with a blank Calculator page:

From the main **File** menu, click **New Document**, and then click **Add Calculator**.

Handheld: Press $\left[\text{on} \right]$, and select **Calculator** $\left[\begin{smallmatrix} \times \\ \div \\ + \\ - \end{smallmatrix} \right]$.

- ▶ To add a Calculator page in the current problem of an existing document:

From the toolbar, click **Insert > Calculator**.

Handheld: Press $\left[\text{doc} \right]$ and select **Insert > Calculator**.

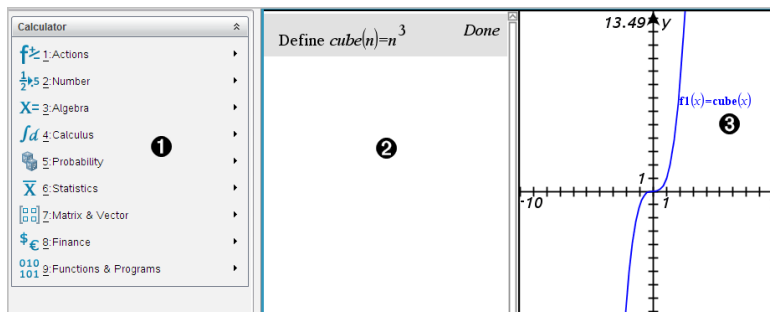

1 Calculator menu. This menu is available anytime you are in the Calculator work area using the Normal view mode. The menu in this screen snapshot may not exactly match the menu on your screen.

2 Calculator work area

- Enter a math expression on the entry line, and then press **Enter** to evaluate the expression.

- Expressions are displayed in standard mathematical notation as you enter them.
 - Entered expressions and results show in the Calculator history.
- ③ Example of Calculator variables used in another application.

Entering and Evaluating Math Expressions

Entering Simple Math Expressions

Note: To enter a negative number on the handheld, press $\boxed{(-)}$. To enter a negative number on a computer keyboard, press the hyphen key (-).

Suppose you want to evaluate $\frac{2^8 \cdot 43}{12}$

1. Select the entry line in the Calculator work area.
2. Type 2^*8 to begin the expression.

2^8

3. Press \blacktriangleright to return the cursor to the baseline.
4. Complete the expression:

Type $*43/12$.

Handheld: Type $\boxed{\times}$ 43 $\boxed{\div}$ 12.

$2^8 \cdot 43 / 12$

5. Press **Enter** to evaluate the expression.

The expression is displayed in standard mathematical notation, and the result is displayed on the right side of the Calculator.

$\frac{2^8 \cdot 43}{12}$	$\frac{2752}{3}$
---------------------------	------------------

Note: If a result does not fit on the same line with the expression, it is displayed on the next line.

Controlling the Form of a Result

You might expect to see a decimal result instead of $2752/3$ in the preceding example. A close decimal equivalent is $917.33333\dots$, but that's only an approximation.

By default, Calculator retains the more precise form: $2752/3$. Any result that is not a whole number is shown in a fractional or (CAS) symbolic form. This reduces rounding errors that could be introduced by intermediate results in chained calculations.

You can force a decimal approximation in a result:

- By pressing shortcut keys.

Windows®: Press **Ctrl +Enter** to evaluate the expression.

Mac®: Press **⌘+Enter** to evaluate the expression.

Handheld: Press instead of to evaluate the expression.

$$\frac{2^{8.43}}{12} \qquad \qquad \qquad 917.333$$

Pressing forces the approximate result.

- By including a decimal in the expression (for example, $43.$ instead of 43).

$$\frac{2^{8.43.}}{12} \qquad \qquad \qquad 917.333$$

- By wrapping the expression in the **approx()** function.

$$\text{approx}\left(\frac{2^{8.43}}{12}\right) \qquad \qquad \qquad 917.333$$

- By changing the document's **Auto or Approximate** mode setting to Approximate.



From the **File** menu, click **Settings > Document Settings**.

Handheld: Press to display the **File** menu.

Note that this method forces all results in all of the document's problems to approximate.

Inserting Items from the Catalog

You can use the Catalog to insert system functions and commands, symbols, and expression templates into the Calculator entry line.

1. Click the **Utilities** tab, and then click  to open the Catalog.
Handheld: Press  1.

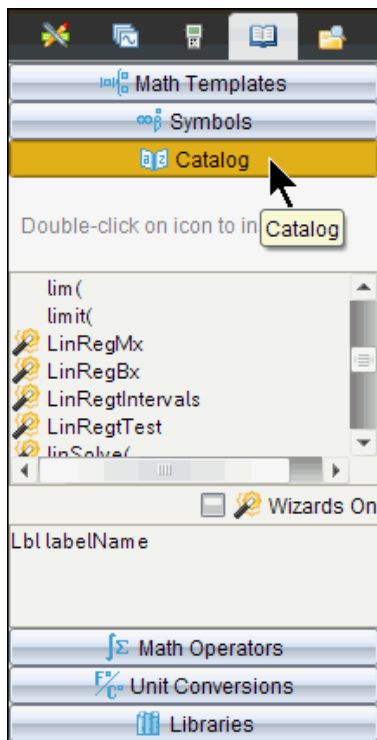

Note: Some functions have a wizard that prompts you for each argument. Those functions are shown with an indicator. To receive the prompts, select **Wizards On**.

2. If the item you are inserting is visible in the list, select it and press **Enter** to insert it.
3. If the item is not visible:

- Click inside the list of functions, and then press a letter key to jump to the entries that begin with that letter.
- Press \blacktriangle or \blacktriangledown as necessary to highlight the item you are inserting. Help, such as syntax information or a short description of the selected item, appears at the bottom of the Catalog.
- Press **Enter** to insert the item into the entry line.

Using an Expression Template

The Calculator has templates for entering matrices, piecewise functions, systems of equations, integrals, derivatives, products, and other math expressions.

$$\sum_{n=3}^7 (n)$$

For example, suppose you want to evaluate $n=3$

- On the **Utilities** tab, click  to open the templates.

Handheld: Press .

- Click  to insert the algebraic sum template.

The template appears on the entry line with small blocks representing elements that you can enter. A cursor appears next to one of the elements to show that you can type a value for that element.

$$\sum_{\square}^{\square} (\square)$$

- Use the arrow keys to move the cursor to each element's position, and type a value or expression for each element.

$$\sum_{n=3}^7 (n)$$

- Press **Enter** to evaluate the expression.

$$\sum_{n=3}^7 (n)$$

Creating Matrices

1. On the **Utilities** tab, click  to open the templates.

Handheld: Press .

2. Click .

The Create a Matrix dialog box opens.

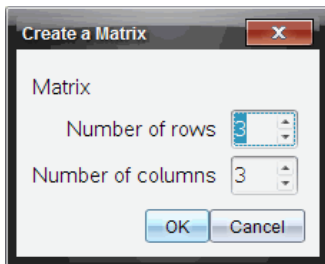

3. Type the **Number of rows**.
4. Type the **Number of columns**, and then click **OK**.

Calculator opens a template with spaces for the rows and columns.

Note: If you create a matrix with a large number of rows and columns, it may take a few moments to appear.

5. Type the matrix values into the template, and then press **Enter** to define the matrix.

Inserting a Row or Column into a Matrix

- ▶ To insert a new row, hold down **Alt** and press **Enter**.
- ▶ To insert a new column, hold down **Shift** and press **Enter**.

Handheld:

- ▶ To insert a new row, press .
- ▶ To insert a new column, press **Shift+Enter**.



Inserting Expressions Using a Wizard

You can use a wizard to simplify entering some expressions. The wizard contains labeled boxes to help you enter the arguments in the expression.

For example, suppose you want to fit a $y = mx + b$ linear regression model to the following two lists:

{1,2,3,4,5}

{5,8,11,14,17}

1. On the **Utilities** tab, click  to open the Catalog.
Handheld: Press  1.
2. Click an entry in the Catalog, and then press **L** to jump to the entries that begin with “L.”
3. Press **▼** as necessary to highlight **LinRegMx**.
4. Select the **Wizards On** option, if it is not already selected:
Handheld: Press **Tab Tab** to highlight **Wizards On**, press **Enter** to change the setting, and then press **Tab Tab** to highlight **LinRegMx** again.
5. Press **Enter**.

A wizard opens, giving you a labeled box to type each argument.

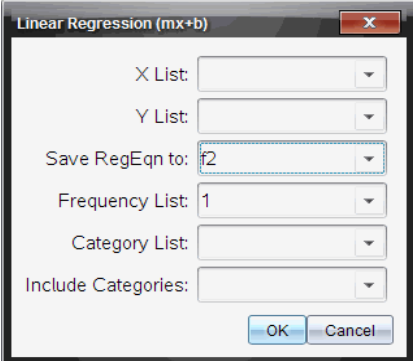

6. Type {1, 2, 3, 4, 5} as **X List**.
7. Press **Tab** to move to the **Y List** box.
8. Type {5, 8, 11, 14, 17} as **Y List**.

- If you want to store the regression equation in a specific variable, press **Tab**, and then replace **Save RegEqn To** with the name of the variable.
- Click **OK** to close the wizard and insert the expression into the entry line.

Calculator inserts the expression and adds statements to copy the regression equation and show the variable *stat.results*, which will contain the results.

LinRegMx {1,2,3,4,5},{5,8,11,14,17},1: CopyVar stat.RegEqn,f2: stat.results

Calculator then shows the *stat.results* variables.

LinRegMx {1,2,3,4,5},{5,8,11,14,17},1: <i>stat.results</i>	
"Title"	"Linear Regression (mx+b)"
"RegEqn"	"m*x+b"
"m"	3.
"b"	2.
"r ² "	1.
"r"	1.
"Resid"	" {... } "

Note: You can copy values from the *stat.results* variables and paste them into the entry line.

Creating a Piecewise Function

- Begin the function definition. For example, type the following expression:

Define $f(x,y) =$

- On the **Utilities** tab, click  to open the templates.

Handheld: Press .

- Click .

The Create Piecewise Function dialog box opens.

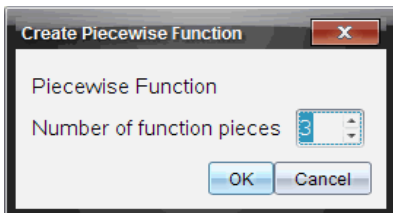

4. Type the **Number of Function Pieces**, and click **OK**.
Calculator opens a template with spaces for the pieces.
5. Type the expressions into the template, and press **Enter** to define the function.
6. Enter an expression to evaluate or graph the function. For example, type the expression $f(1, 2)$ on the Calculator entry line.

Creating a System of Equations

1. On the **Utilities** tab, click  to open the templates.

Handheld: Press .

2. Click .

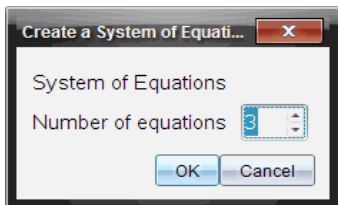

The Create a System of Equations dialog box opens.



3. Type the **Number of Equations**, and click **OK**.
Calculator opens a template with spaces for the equations.
4. Type the equations into the template, and press **Enter** to define the system of equations.

CAS: Working with Measurement Units

A list of pre-defined constants and measurement units is available in the Catalog. You can also create your own units.

Note: If you know a unit's name, you can type the unit directly. For example, you can type `_qt` to specify quarts. To type the underscore symbol on the handheld, press  .

CAS: Converting Between Measurement Units

You can convert a value between any two units within the same category (such as length).

Example: Using the Catalog, convert 12 meters to feet. The desired expression is $12 \cdot \text{m} \blacktriangleright \text{ft}$.

1. Type **12** on the entry line.
2. On the **Utilities** tab, click $\frac{F}{C}$ to show the unit conversions.

Handheld: Press  **3**.

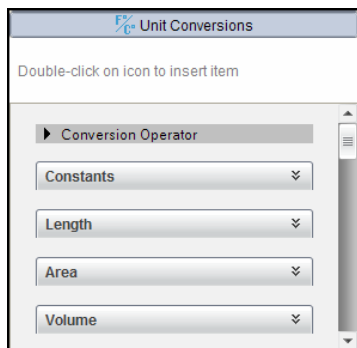

3. Click the **Length** category to expand the list of pre-defined length units.

Handheld: Scroll to the **Length** category, and press **Enter**.

4. Scroll to **meter**.

Handheld: Scroll to **_m** (noting the **meter** hint in the Help window).

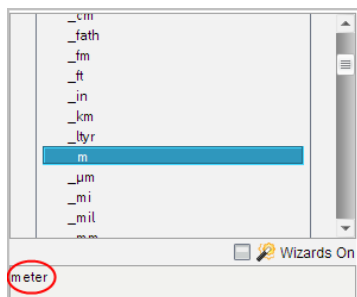

5. Press **Enter** to paste **_m** to the entry line.

12 *m*

6. Click the Conversion Operator (\blacktriangleright) at the top of the Units list, and press **Enter** to paste it to the entry line.

12_m \blacktriangleright

7. Select **_ft** from the Length category, and press **Enter**.

12_m \blacktriangleright _ft

8. Press **Enter** to evaluate the expression.

12_m \blacktriangleright _ft 39.3701·_ft

CAS: Creating a User-defined Unit

As with the pre-defined units, user-defined unit names must begin with an underscore symbol.

Example: Using the pre-defined units *_ft* and *_min*, define a unit named *_fpm* that lets you enter velocity values in feet per minute and convert velocity results to feet per minute.

Define $_fpm = \frac{_ft}{_min}$ *Done*

Now you can use the new velocity unit *_fpm*.

15·_knot \blacktriangleright _fpm 1519.03·_fpm

160·_mph \blacktriangleright _fpm 14080·_fpm

500·_fpm \blacktriangleright _knot 4.93737·_knot

Working with Variables

When you first store a value in a variable, you give the variable a name.

- If the variable does not already exist, Calculator creates it.
- If the variable already exists, Calculator updates it.

Variables within a problem are shared by TI-Nspire™ applications. For example, you can create a variable in Calculator and then use or modify it in Graphs & Geometry or Lists & Spreadsheet within the same problem.

For more information, see *Using Variables*.

Creating User-defined Functions and Programs

You can use the **Define** command to create your own functions and programs. You can create them in the Calculator application or in the Program Editor and then use them in other TI-Nspire™ applications.

For more information, see *Overview of the Program Editor and Libraries*.

Defining a Single-line Function

Suppose you want to define a function named **cube()** that calculates the cube of a number or variable.

1. On the Calculator entry line, type **Define cube(x)=x^3** and press **Enter**.

Define $cube(x)=x^3$	Done
----------------------	------

The message “Done” confirms that the function has been defined.

2. Type **cube(2)** and press **Enter** to test the function.

$cube(2)$	8
-----------	---

Defining a Multiple-line Function Using Templates

You can define a function consisting of multiple statements entered on separate lines. A multiple-line function may be easier to read than one with multiple statements separated by colons.

Note: You can create multiple-line functions only by using the **Define** command. You cannot use the **:=** or **→** operators to create multiple-line definitions. The **Func...EndFunc** template serves as a container for the statements.

As an example, define a function named **g(x,y)** that compares two arguments x and y . If argument $x >$ argument y , the function should return the value of x . Otherwise, it should return the value of y .

1. On the Calculator entry line, type **Define g(x,y)=**. Do not press **Enter** yet.

define $g(x,y)=$

2. Insert the **Func...EndFunc** template.

From the **Functions & Programs** menu, select **Func...EndFunc**.

Calculator inserts the template.

```
define g(x,y)=Func
      |
      EndFunc
```

3. Insert the **If...Then...Else...EndIf** template.

From the **Functions & Programs** menu, select **Control**, and then select **If...Then...Else...EndIf**.

Calculator inserts the template.

```
define g(x,y)=Func
      If | Then
          |
          Else
          |
          EndIf
      EndFunc
```

4. Type the remaining parts of the function, using the arrow keys to move the cursor from line to line.

```
define g(x,y)=Func
      If x>y Then
          return x
      Else
          return y |
      EndIf
      EndFunc
```

5. Press **Enter** to complete the definition.
6. Evaluate $g(3, -7)$ to test the function.

```
g(3,-7) 3
```

Defining a Multiple-line Function Manually

- ▶ To start each new line without completing the function definition, hold down **Alt** and press **Enter**

Handheld: Press  instead of pressing **Enter**.

As an example, define a function **sumIntegers(x)** that calculates the cumulative sum of integers from 1 through x .

1. On the Calculator entry line, type **Define sumIntegers(x)=**. Do not press **Enter** yet.

```
Define sumIntegers(x)=|
```

2. Insert the **Func...EndFunc** template.

From the **Functions & Programs** menu, select **Func...EndFunc**.

Calculator inserts the template.

```
Define sumIntegers(x)=Func
                        |
                        ...
                        EndFunc
```

3. Type the following lines, pressing \square or **Alt+Enter** at the end of each line.

```
Define sumIntegers(x)=Func
    Local i,tmpsum
    tmpsum:=0
    For i,1,x
        tmpsum:=tmpsum+i
    EndFor
    Return tmpsum
EndFunc
```

4. After typing **Return tmpsum**, press **Enter** to complete the definition.
5. Evaluate **sumIntegers(5)** to test the function.

```
sumIntegers(5) 15
```

Defining a Program

Defining a program is similar to defining a multiple-line function. The **Prgm...EndPrgm** template serves as a container for the program statements.

As an example, create a program named **g(x,y)** that compares two arguments. Based on the comparison, the program should show the text " $x>y$ " or " $x\leq y$ " (showing the values of x and y in the text).

1. On the Calculator entry line, type **Define prog1(x,y)=**. Do not press **Enter** yet.

Define *prog1*(*x,y*)=|

2. Insert the **Prgm...EndPrgm** template.

From the **Functions & Programs** menu, select **Prgm...EndPrgm**.

Define *prog1*(*x,y*)=Prgm
|
EndPrgm

3. Insert the **If...Then...Else...EndIf** template.

From the **Functions & Programs** menu, select **Control**, and then select **If...Then...Else...EndIf**.

Define *prog1*(*x,y*)=Prgm
If|Then

Else

EndIf
EndPrgm

4. Type the remaining parts of the function, using the arrow keys to move the cursor from line to line. Use the Symbol Palette to select the " \leq " symbol.

Define *prog1*(*x,y*)=Prgm
If *x*>*y* Then
Disp *x*," > ",*y*
Else
Disp *x*," ≤ ",*y*|
EndIf
EndPrgm

5. Press **Enter** to complete the definition.
6. Execute **prog1 (3, -7)** to test the program.

prog1(3,-7)

3 > -7

Done

Recalling a Function or Program Definition

You might want to reuse or modify a function or program that you have defined.

1. Show the list of defined functions.

From the **Actions** menu, select **Recall Definition**.

2. Select the name from the list.

The definition (for example, `Define f(x)=1/x+3`) is pasted into the entry line for editing.

Editing Calculator Expressions

Although you cannot edit an expression in the Calculator history, you can copy all or part of an expression from the history and paste it to the entry line. You can then edit the entry line.

Positioning the Cursor in an Expression

- ▶ Press **Tab**, **◀**, **▶**, **▲**, or **▼** to move the cursor through the expression. The cursor moves to the closest valid position in the direction that you press.

Note: An expression template may force the cursor to move through its parameters, even though some parameters may not be exactly in the path of the cursor movement. For example, moving upward from the main argument of an integral always moves the cursor to the top limit.

Inserting into an Expression in the Entry Line

1. Position the cursor at the point where you want to insert additional elements.
2. Type the elements that you want to insert.

Note: When you insert an open parenthesis, Calculator adds a temporary close parenthesis, displayed in gray. You can override the temporary parenthesis by typing the same parenthesis manually or by entering something past the temporary parenthesis (thereby implicitly validating its position in the expression). After you override the temporary gray parenthesis, it is replaced with a black parenthesis.

Selecting Part of an Expression

1. Position the cursor at the starting point in the expression.

Handheld: Press ◀, ▶, ▲, or ▼ to move the cursor.

2. Press and hold **Shift**, and then press ◀, ▶, ▲, or ▼ to select.

Deleting all or part of an expression on the entry line

1. Select the part of the expression to delete.
2. Press **Del**.

Financial Calculations

Several TI-Nspire™ functions provide financial calculations, such as time value of money, amortization calculations, and return on investment calculations.

The Calculator application also includes a Finance Solver. It lets you dynamically solve several types of problems, such as loans and investments.

Using the Finance Solver

1. Open the Finance Solver.

From the **Finance** menu, click **Finance Solver**.

The Finance Solver displays its default values (or previous values, if you have already used the solver in the current problem).

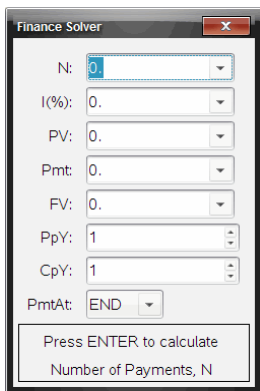

The screenshot shows the Finance Solver dialog box with the following fields and values:

N:	0
I(%):	0.
PV:	0.
Pmt:	0.
FV:	0.
PpY:	1
CpY:	1
PmtAt:	END

At the bottom of the dialog, there is a button labeled "Press ENTER to calculate" and a note "Number of Payments, N".

2. Enter each known value, using **Tab** to cycle through the items.
 - The help information at the bottom of the Finance Solver describes each item.
 - You might need to temporarily skip the value that you want to calculate.

- Make sure to set **PpY**, **CpY**, and **PmtAt** to the correct settings (12, 12, and END in this example).
3. Press **Tab** as necessary to select the item that you want to calculate, and then press **Enter**.

The Finance Solver calculates the value and stores all the values in “tvm.” variables, such as *tvm.n* and *tvm.pmt*. These variables are accessible to all TI-Nspire™ applications within the same problem.

Finance Solver

N: 60

I(%): 10.5

PV: 25000

Pmt: 537.34750945294

FV: 0

PpY: 12

CpY: 12

PmtAt: END

Finance Solver info stored into
tvm.n, tvn.i, tvn.pv, tvn.pmt, ...

Finance Functions Included

In addition to the Finance Solver, TI-Nspire™ built-in finance functions include:

- TVM functions for calculating future value, present value, number of payments, interest rate, and payment amount.
- Amortization information such as amortization tables, balance, sum of interest payments, and sum of principal payments.
- Net present value, internal rate of return, and modified rate of return.
- Conversions between nominal and effective interest rates, and calculation of days between dates.

Notes:

- Finance functions do not automatically store their argument values or results to the TVM variables.
- For a complete list of TI-Nspire™ functions, see the *Reference Guide*.

Working with the Calculator History

As you enter and evaluate expressions in the Calculator application, each entry/result pair is saved in the Calculator history. The history gives you a way to review your calculations, repeat a set of calculations, and copy expressions for reuse in other pages or documents.

Viewing the Calculator History

Note: You may notice a processing slowdown when the history contains a large number of entries.

- ▶ Press ▲ or ▼ to scroll through the history.

$\frac{3.76}{-7.9+\sqrt{5}}$	-0.66385
$-0.66384977522033+2 \cdot \log_{10}(45)$	2.64258
$a:=5;b:=2;\frac{a}{b} \cdot 1$	2.5
Define $cube(x)=x^3$	Done

Copying a Calculator History Item to the Entry Line

You can quickly copy an expression, subexpression, or result from the history into the entry line.

1. Press ▲ or ▼ to move through the history and select the item that you want to copy.

–or–

Select part of the expression or result by using **Shift** in combination with the arrow keys.

$\frac{3.76}{-7.9+\sqrt{5}}$	-0.66385
------------------------------	----------

Note: The float setting for the current document may limit the number of decimal places displayed in a result. To capture the result in its full

precision, select it either by scrolling with the up and down arrow keys or by triple-clicking it.

2. Press **Enter** to copy the selection and insert it into the entry line.

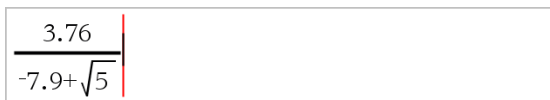
$$\frac{3.76}{-7.9+\sqrt{5}}$$

Copying a History Item to Another Application

1. Press **▲** or **▼** to move through the history and select the item that you want to copy.
2. Optionally, select part of the expression or result by pressing **Shift** in combination with the arrow keys.
3. Use the standard key shortcut for copying a selection.

Windows®: Press **Ctrl+C**.

Mac®: Press **⌘+C**.

Handheld: Press **ctrl** **C**.

4. Place the cursor at the location where you want the copy.
5. Paste the copy.

Windows®: Press **Ctrl+V**.

Mac®: Press **⌘+V**.

Handheld: Press **ctrl** **V**.

Note: If you copy an expression that uses variables into a different problem, the values of those variables are not copied. You must define the variables in the problem where you paste the expression.

Deleting an Expression from the History

When you delete an expression, all variables and functions defined in the expression retain their current values.

1. Drag or use the arrow keys to select the expression.

Handheld: Use the arrow keys.

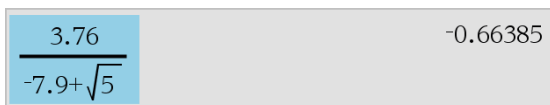
$$\frac{3.76}{-7.9+\sqrt{5}} \quad -0.66385$$

2. Press **Del**.

The expression and its result are removed.

Clearing the Calculator History

When you clear the history, all variables and functions defined in the history retain their current values. If you clear the history by mistake, use the undo feature.

- ▶ From the **Actions** menu, select **Clear History**.

All expressions and results are removed from the history.

Using Variables

A variable is a defined value that can be used multiple times in a problem. You can define a value or function as a variable within each application. Within a problem, variables are shared by TI-Nspire™ applications. For example, you can create a variable in Calculator, and then use or modify it in Graphs & Geometry or Lists & Spreadsheet within the same problem.

Each variable has a name and a definition and the definition can be changed. When you change the definition, all occurrences of the variable in the problem are updated to use the new definition. In the TI-Nspire™ software, a variable has four attributes:

- Name - User-defined name assigned when the variable is created.
- Location - Variables are stored in memory.
- Value - Number, text, mathematical expression, or function.
- Type - Type of data that can be stored as a variable.

Note: Variables created with the **Local** command within a user-defined function or program are not accessible outside that function or program.

Linking Values on Pages

Values and functions created or defined in one application can interact with other applications (within the same problem) to share data.

When using linked items, keep in mind:

- Values can be linked between applications on one page or between different pages of the same problem.
- All applications are linked to the same data.
- If the linked value is changed in the original application, the change is reflected in all linked usages.

Defining a variable is the first step in linking values.





Creating Variables

Any portion or attribute of an object or function created within an application can be stored as a variable. Examples of attributes that can become variables are the area of a rectangle, the radius of a circle, the value contained in a

spreadsheet cell or the contents of a row or column, or a function expression. When you create a variable, it is stored in memory.

Types of Variables

You can store the following data types as variables:

Data type	Examples
Expression 	2.54 $1.25E6$ 2π $x_{min}/10$ $2+3i$ $(x-2)^2$ $\frac{\sqrt{2}}{2}$
List 	$\{2, 4, 6, 8\}$ $\{1, 1, 2\}$ $\{\text{"red"}, \text{"blue"}, \text{"green"}\}$
Matrix 	$\begin{bmatrix} 1 & 2 & 3 \\ 3 & 6 & 9 \end{bmatrix}$ This can be entered as: $[1, 2, 3; 3, 6, 9]$
Character string	"Hello" "xmin/10" "The answer is."
Function, program 	myfunc(arg) $\text{ellipse(x, y, r1, r2)}$
Measurement 	$\text{area, perimeter, length, slope, angle}$

When you click  or press `var` on a handheld to open the list of stored variables, a symbol indicates the type.

Creating a Variable from a Calculator Value

This example shows how to create a variable using a handheld. Complete the following steps to create a variable named *num* and store the result of the expression $5+8^3$ in that variable.

1. On the Calculator entry line, type the expression $5+8^3$.

$$5+8^3$$

- Press **▶** to expand the cursor to the baseline.

$5+8^3$

- Press **ctrl** **var** and then type the variable name **num**.

$5+8^3 \rightarrow \mathbf{num}$

This means: Calculate $5+8^3$ and store the result as a variable named *num*.

- Press **enter**.

Calculator creates the variable *num* and stores the result there.

$5+8^3 \rightarrow \mathbf{num}$

517

Creating a Variable in the Computer Software

When creating a variable in the computer software, use the following conventions. As alternatives to using \rightarrow (store), you can use “:=” or the **Define** command. All of the following statements are equivalent.

$5+8^3 \rightarrow \mathbf{num}$

$\mathbf{num} := 5+8^3$

Define $\mathbf{num}=5+8^3$

Checking a Variable's Value

You can check the value of an existing variable by entering its name on the Calculator entry line. When you type the name of a stored variable, it appears in bold type.

- On the Calculator entry line, type the variable name **num** and press **enter**.

The value most recently stored in *num* is displayed as the result.

num

517

Automatically Creating Variables in Graphs & Geometry

In the Graphs and Geometry applications, functions defined on the entry line are automatically stored as variables.

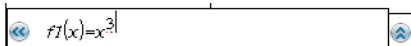

A calculator entry line with a left arrow button, the text $f1(x)=x^3$, and a right arrow button.

In this example, $f1(x)=x^3$ is a variable definition, which allows it to be displayed in other applications including a table in the Lists & Spreadsheet application.

Creating a Variable from a Graphs & Geometry Value

1. Click the value to store as a variable.



2. Click .

Handheld: Press .

The Variables options are displayed with **Store Var** highlighted.

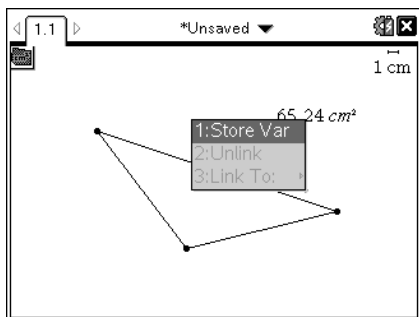

3. Press . VAR := appears before the selected value. This is the default name.

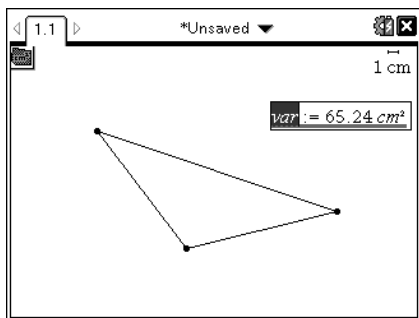

- Replace the default name VAR with the variable name you want to give the value.
- When the variable name is typed, press **enter**.

The value is saved to that variable name, and the stored value or its name appears in bold text to indicate it is a stored value.

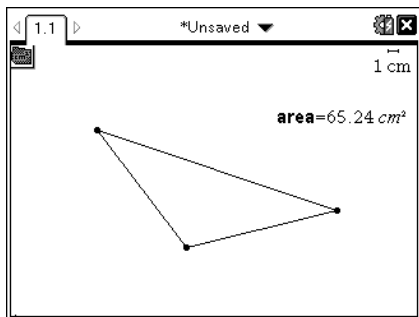

Note: You can also share a Graphs & Geometry axis end value with other applications. If necessary, click **Actions, Show/Hide Axes End Values** to display the end values on the horizontal and vertical axes. Click the number for an end value to highlight it in the entry field. Name the variable and store it for use with other applications by using any method described in Step 2.

Automatically Creating Variables in Lists & Spreadsheet

Naming a list at the top of a Lists & Spreadsheet column automatically stores that value as a list variable. This variable can be used in other applications including Data & Statistics.

Creating a Variable from a Lists & Spreadsheet Cell Value

You can share a cell value with other applications. When defining or referring to a shared cell in Lists & Spreadsheet, precede the name with an apostrophe (').

- Click the cell that you want to share.
- Click  to open the Variables menu.
Handheld: Press **var**.

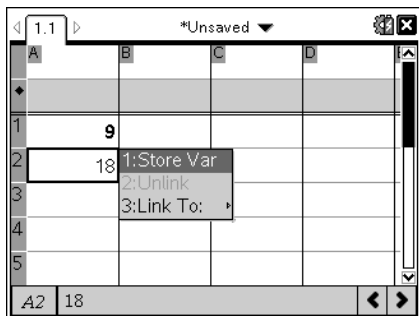

3. Click **Store Var**.

A formula is inserted into the cell with *var* as a placeholder for a variable name.

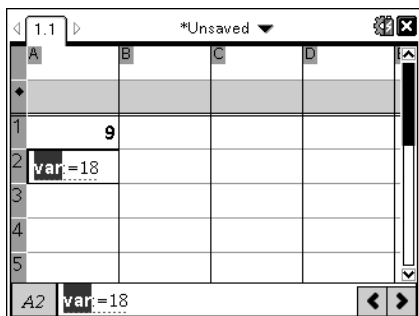

4. Replace the letters “*var*” with a name for the variable, and press **enter**.

The value is now available as a variable to other applications within the same problem.

Note: If a variable with the name you specified already exists in the current problem space, Lists & Spreadsheet displays an error message.

Using (Linking) Variables

Sharing, or linking, the variables you create is a powerful tool for math exploration. The display of linked variables is automatically updated when the variable’s value changes.

Linking to Shared Variables

To use a stored variable:

1. Display the page and select the location or object to which you want to link a variable.

2. Select the Variables tool .

The Variables options are displayed. The software knows which types of variables will work in the location or with the object selected and will only display those variables.

3. Use ▲ and ▼ to scroll the list.

–or–

Type part of the variable name.

As you type, the system displays a list of variables that begin with the letters you typed. Typing part of the name enables you to locate a variable more quickly if the list is long.

4. When you locate and highlight the name of the variable you want to use, click the name.

–or–

Press .

The selected variable value is linked.



Linking a Lists & Spreadsheet Cell to a Variable

When you link a cell to a variable, Lists & Spreadsheet keeps the cell value updated to reflect the current value of the variable. The variable can be any variable in the current problem and can be defined in Graphs & Geometry, Calculator, or any instance of Lists & Spreadsheet.

Note: Do not link to a system variable. Doing so could prevent the variable from being updated by the system. System variables include *ans*, *StatMatrix*, and statistics results (such as *RegEqn*, *dfError*, and *Resid*).

1. Click the cell that you want to link to the variable.

2. Open the VarLink menu:

- Click , and then click **Cell**.
- Handheld: Press .

The VarLink menu is displayed.

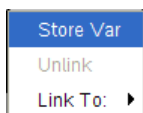

3. Under **Link To**, scroll to the name of the variable and click it.

The cell shows the value of the variable.

Using a Variable in a Calculation

After storing a value in a variable, you can use the variable name in an expression as a substitute for the stored value.

1. Enter the expression:

- Type $4 \cdot 25 \cdot \mathit{num}^2$ on the entry line, and press **Enter**.
- Handheld: Type 4 25 num^2 on the entry line, and press .

Calculator substitutes 517, the value currently assigned to num , and evaluates the expression.

$$4 \cdot 25 \cdot \mathit{num}^2 \qquad 26728900$$

2. Enter the expression:

- Type $4 \cdot 25 \cdot \mathit{nonum}^2$, and press **Enter**.
- Handheld: Type 4 25 nonum^2 on the entry line, and press .

$$4 \cdot 25 \cdot \mathit{nonum}^2 \qquad 100 \cdot \mathit{nonum}^2$$

CAS: Because the variable nonum has not been defined, it is treated algebraically in the result.

$$4 \cdot 25 \cdot \mathit{nonum}^2$$

"Error: Variable is not defined"

Because the variable nonum has not been defined, the expression returns an error message.

Entering Multiple Statements on the Entry Line

To enter several statements on a single line, separate them with a colon (":"). Only the result of the last expression is shown.

$$a:=5: b:=2: \frac{a}{b} \cdot 1. \qquad 2.5$$

Setting Variable Values with a Slider

In the Graphs and Geometry applications, a slider control lets you adjust or animate the assignment of values for a numeric variable. Use a slider to represent multiple variable values in a continuous range.

1. From the Document Tools menu, click **Actions > Insert Slider**.

Handheld: Press **[menu]** **[1]** **[A]** to insert a slider.

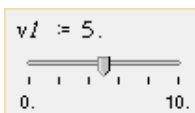

The slider is displayed on the work area. If you need to adjust or animate value selection for more than one variable, you can repeat this step and insert multiple sliders.

Note: You can access the context menu to Pin a slider to its location and prevent unintentional movement.

2. Click the slider to activate it and press **[tab]** to move between the slider scale and the variable's value.
3. Use **[left arrow]** and **[right arrow]** to move the slider on the scale.
4. Press **Enter** to select the value.

Access the context menu and choose **Settings** to view or change the default slider settings.

Naming Variables

Variable and function names that you create must meet the following naming rules.

Note: In the unlikely event that you create a variable with the same name as one used for statistical analysis or by the Finance Solver, an error condition

could occur. If you begin entering a variable name that is already in use in the current problem, the software shows the entry in **bold** to let you know.

- Variable names must be in one of the forms xxx or $xxx.yyy$. The xxx part can have 1 to 16 characters. The yyy part, if used, can have 1 to 15 characters. If you use the $xxx.yyy$ form, both xxx and yyy are required; you cannot start or end a variable name with a period “.”.
- Characters can consist of letters, digits, and the underscore character ($_$). Letters can be U.S. or Greek letters (but not Π or π), accented letters, and international letters.
- Do not use **c** or **n** from the symbol palette to construct a variable name such as **c1** or **n12**. These may appear to be letters, but they are treated internally as special symbols.
- You can use uppercase or lowercase letters. The names $AB22$, $Ab22$, $aB22$, and $ab22$ all refer to the same variable.
- You cannot use a digit as the first character of xxx or yyy .
- You can use digits 0 through 9, U.S. letters, a - z, Latin and Greek letters (but not π , α , σ , β , σ , χ , ρ , π , σ , ϕ , ρ , $\bar{\alpha}$, μ , π , λ , $\ast a_2$, q_d , or h_2o). To enter a subscript while typing a variable name, select \square in the Math Templates or on the formatting toolbar.
- Do not use spaces.
- If you want a variable to be treated as a complex number, use an underscore as the last character of the name.
- CAS: If you want a variable to be treated as a type of unit (such as $_m$ or $_ft$), use an underscore as the first character of the name. You cannot use subsequent underscores in the name.
- You cannot use an underscore as the first character of the name.
- You cannot use a preassigned variable, function, or command name, such as **Ans**, **min**, or **tan**.

Note: For more information about TI-Nspire™ functions, see the *Reference Guide*.

- Library documents and library objects are subject to additional naming restrictions. For more information, see *Libraries*.

Here are some examples:

Variable names	Valid?
<i>Myvar, my.var</i>	Yes
<i>My var, list 1</i>	No. Contains a space.
<i>a, b, b12, b₁₂, c, d</i>	Yes. Note that variables <i>b12</i> and <i>b₁₂</i> are distinct.
<i>Log, Ans</i>	No. Preassigned to a system function or variable.
<i>Log1, list1.a, list1.b</i>	Yes
<i>3rdTotal, list1.1</i>	No. <i>xxx</i> or <i>yyy</i> starts with a digit.

Locking and Unlocking Variables

Locking lets you protect variables from modification or deletion. Locking prevents unintended changes to a variable.

	A time...	B altitude...
1	seconds	meters
2	10	64
3	20	59
4	70	49
5	90	44
6		
	A2	10

Time and altitude lists can be locked to ensure problem fidelity.

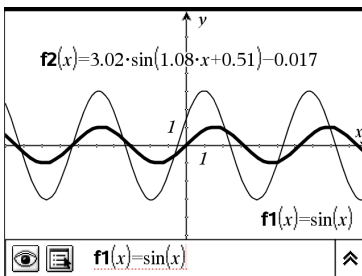

*Reference function **f1** can be locked to prevent unintended change.*

Variables you Cannot Lock

- System variable *Ans*
- *stat.* and *tvm.* variable groups

Important Information About Locked Variables

- To lock variables, use the Lock command.
- To modify or delete a locked variable, you must first unlock the item.
- Locked variables display a lock icon on the variable menu list.
- The Lock command clears the Redo/Undo history when applied to unlocked variables.

Examples of Locking

<code>Lock a,b,c</code>	Locks variables <i>a</i> , <i>b</i> , and <i>c</i> from the Calculator application.
<code>Lock mystats.</code>	Locks all members of variable group <i>mystats</i> .
<code>UnLock func2</code>	Unlocks variable <i>func2</i> .
<code>lm:=getLockInfo (var2)</code>	Retrieves the current lock status of <i>var2</i> and assigns that value to <i>lm</i> in the Calculator application.

For more information, see the *Reference Guide*.

Updating a Variable

If you want to update a variable with the result of a calculation, you must store the result explicitly.

Entry	Result	Comment
<code>a := 2</code>	2	
<code>a³</code>	8	Result not stored in variable <i>a</i> .
<code>a</code>	2	
<code>a := a³</code>	8	Variable <i>a</i> updated with result.
<code>a</code>	8	
<code>a² → a</code>	64	Variable <i>a</i> updated with result.

Entry	Result	Comment
a	64	

Reusing the Last Answer

Each instance of Calculator automatically stores the last calculated result as a variable named Ans. You can use Ans to create a chain of calculations.

Note: Do not link to Ans or any system variable. Doing so could prevent the variable from being updated by the system. System variables include statistics results (such as *Stat.RegEqn*, *Stat.dfError*, and *Stat.Resid*) and Finance Solver variables (such as *tvm.n*, *tvm.pmt*, and *tvm.fv*).

As an example of using Ans, calculate the area of a garden plot that is 1.7 meters by 4.2 meters. Then use the area to calculate the yield per square meter if the plot produces a total of 147 tomatoes.

1. Calculate the area:

- On the Calculator entry line, type $1.7 \cdot 4.2$, and press **Enter**.
- Handheld: On the Calculator entry line, type 1.7 \times 4.2 , and press $\boxed{\text{enter}}$.

1.7·4.2	7.14
---------	------

2. Reuse the last answer to calculate the yield per square meter:

- Type $147/\text{ans}$, and press **Enter** to find the yield.
- Handheld: Type 147 \div ans , and press $\boxed{\text{enter}}$ to find the yield.

$\frac{147}{7.14}$	20.5882
--------------------	---------

3. As a second example, calculate $\frac{3.76}{-7.9 + \sqrt{5}}$ and then add $2 \cdot \log(45)$.

- Type $3.76 / (-7.9 + \sqrt{5})$, and press **Enter**.
- Handheld: Type 3.76 \div $(\ominus) 7.9 + \sqrt{5}$, and press $\boxed{\text{enter}}$.

$\frac{3.76}{-7.9 + \sqrt{5}}$	-0.66385
--------------------------------	----------

4. Reuse the last answer:

- Type $\text{ans}+2*\log(45)$, and press **Enter**.
- Handheld: Type $\text{ans}+2 \times \log(45)$, and press **enter**.

$$-0.66384977522033+2\cdot\log_{10}(45) \quad 2.64258$$

Temporarily Substituting a Value for a Variable

Use the “|” (such that) operator to assign a value to a variable for just a single execution of the expression.

$a:=200.12$	200.12
$a^2 a=100$	10000
a	200.12

Removing a Linked Variable

1. Select the linked variable.
2. Press **var**.

The Variables options are displayed.

3. Select **Unlink**.

The link is removed from the value, and the value is displayed without any bold formatting.

Graphs Application

The Graphs application lets you:

- Graph and explore functions and other relations, such as inequalities, parametrics, polars, sequences, differential equation solutions, and conics.
- Animate points on objects or graphs and explore their behavior.
- Link to data created by other applications.

Adding a Graphs Page

- ▶ To start a new document with a blank Graphs page:

From the main **File** menu, click **New Document**, and then click **Add Graphs**.

Handheld: Press **[on]**, and select **Graphs**.

- ▶ To add a Graphs page in the current problem of an existing document:

From the toolbar, click **Insert > Graphs**.

Handheld: Press **[doc]** and select **Insert > Graphs**.

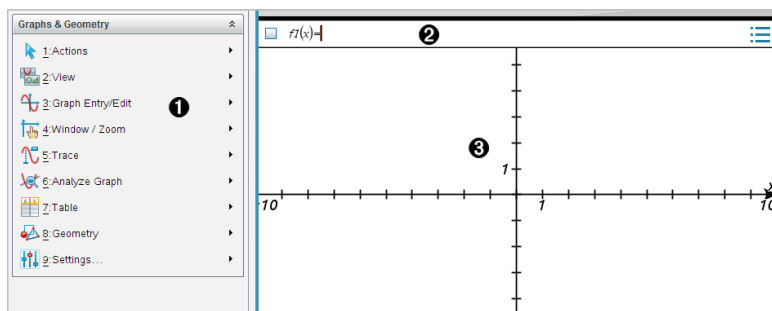

- 1 Graphs & Geometry menu.** Contains tools for defining, viewing, and investigating relations.
- 2 Entry line.** Lets you define the relations that you want to graph. The default graph type is Function, so the form $f1(x)=$ is displayed initially. You can define multiple relations for each of several graph types.
- 3 Graphs Work Area**
 - Shows graphs of relations that you define on the entry line.
 - Shows points, lines, and shapes that you create with geometry tools.

- Drag the area to pan (affects only those objects created in the Graphs application).

What You Must Know

Changing the Graphs and Geometry Settings

1. From the **Settings** menu, select **Settings**.
2. Select the settings that you want to use.
 - **Display Digits.** Sets the display format for numbers as Floating or Fixed decimal.
 - **Graphing Angle.** Sets angle unit for the Graphs application only. To use the current Document Settings, set this to **Auto**.
 - **Geometry Angle.** Sets angle unit for the Geometry application only. To use the current Document Settings, set this to **Auto**.
 - **Automatically hide plot labels.** In the Graphs application, hides the label that normally appears next to a graphed relation.
 - **Show axis end values.** Applies only in the Graphs application.
 - **Show tool tips for function manipulation.** Applies only in the Graphs application.
 - **Automatically find points of interest.** In the Graphs application, shows zeros, minima, and maxima while tracing function graphs.
 - Click **Restore** to restore all settings to their factory defaults.
 - Click **Make Default** to apply the current settings to the open document and save them as the default for new Graphs and Geometry documents.

Using Context Menus

Context menus provide quick access to commonly used commands and tools that apply to a specific object. For example, you can use a context menu to change an object's line color or to group a set of selected objects.

- ▶ Display the context menu for an object in one of the following ways.
 - Windows®: Right-click the object.
 - Mac®: Hold \mathcal{K} and click the object.
 - Handheld: Move the pointer to the object, and then press ctrl menu.

Finding Hidden Objects in the Graphs or Geometry Application

You can hide and show individual graphs, geometric objects, text, labels, measurements, and axis end-values.

To temporarily view hidden graphs or objects or to restore them as shown objects:

1. From the **Actions** menu, select **Hide/Show**.

The Hide/Show tool  appears in the work area, and all hidden objects become visible in dimmed colors.

2. Click a graph or object to toggle its Hide/Show state.
3. To apply the changes and close the Hide/Show tool, press **ESC**.

Inserting a Background Image

You can insert an image as a background for a Graphs or Geometry page. The file format of the image can be .bmp, .jpg, or .png.

1. From the **Insert** menu, click **Image**.
2. Navigate to the image you want to insert, select it, and then click **Open**.

For information on moving, resizing, and deleting a background image, see [Working with Images in the Software](#).

Adding Text to the Graphs or Geometry Work Area

1. From the **Actions** menu, select **Text**.

The Text tool  appears in the work area.

2. Click the location for the text.
3. Type the text in the box that appears, and then press **Enter**.

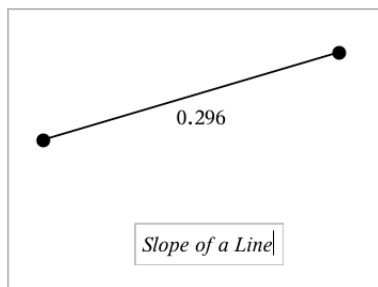

4. To close the Text tool, press **ESC**.

- To edit the text, double-click it.

Deleting a Relation and its Graph

- Select the relation by clicking its graph.
- Press **Backspace** or **DEL**.

The graph is removed from both the work area and the graph history.

Graphing Functions

- From the **Graph Entry/Edit** menu, select **Function**.

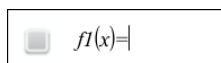

- Type an expression for the function.

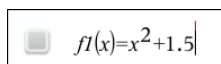

- Press **Enter** to graph the function.

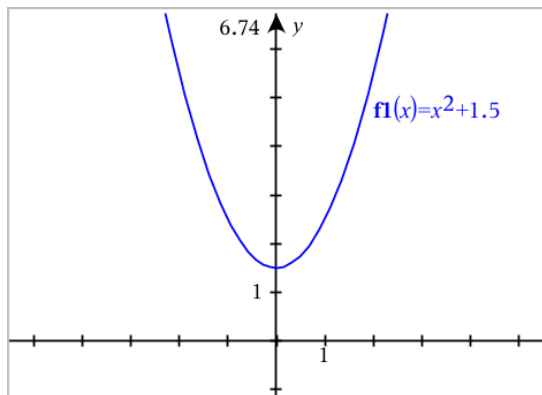

Manipulating Functions by Dragging

Some types of functions can be translated, stretched, and/or rotated by dragging parts of the graph. As you drag, the expression for the graph updates to reflect the change.

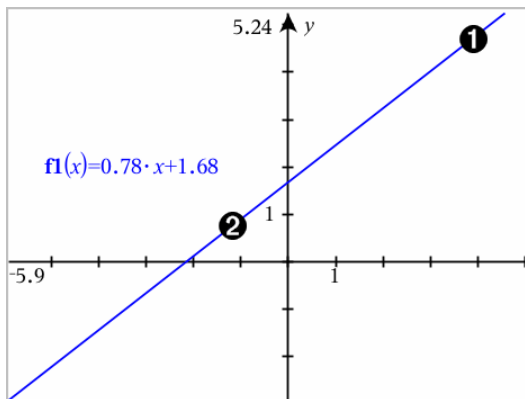

- ❶ Drag graph from the ends to rotate.
- ❷ Drag graph near the middle to translate.

Manipulating a Linear Function

- ▶ To translate, grab near the middle of the graph, and then drag.

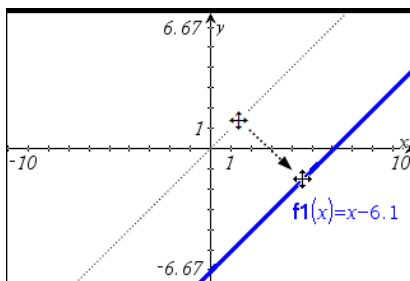

- ▶ To rotate, grab near the ends of the graph, and then drag.

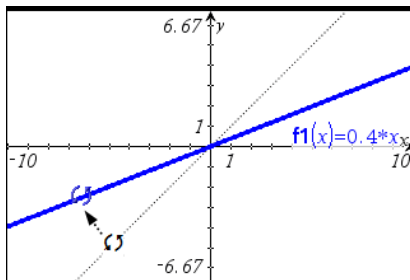

Manipulating a Quadratic Function

- ▶ To translate, grab near the vertex of the graph, and then drag.

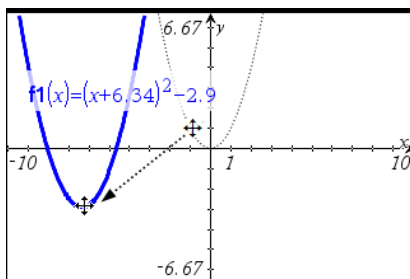

- ▶ To stretch, grab away from the vertex of the graph, and then drag.

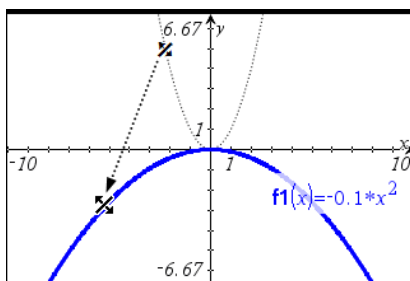

Manipulating a Sine or Cosine Function

- ▶ To translate, grab near the axis of vertical symmetry of the graph, and then drag.

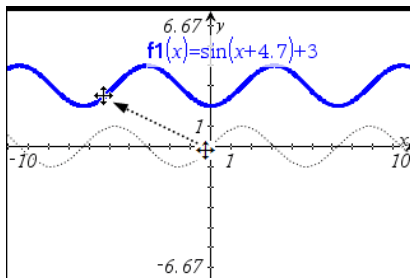

- ▶ To stretch, grab away from the axis of vertical symmetry of the graph, and then drag.

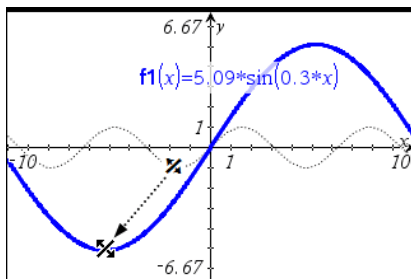

Specifying a Function with Domain Restrictions

You can use the entry line or the Calculator application to specify a function with domain restrictions. For multiple domain restrictions on a function, use the **piecewise()** function.

In the following example, a function with a domain that is less than 2 and greater than -2 is specified on the entry line:

1. From the **Graph Entry/Edit** menu, select **Function**.
2. Type the following on the entry line, using spaces to separate the "and" operator:
piecewise(3,x>-2 and x<2)
3. Tap **Enter** to graph the function.

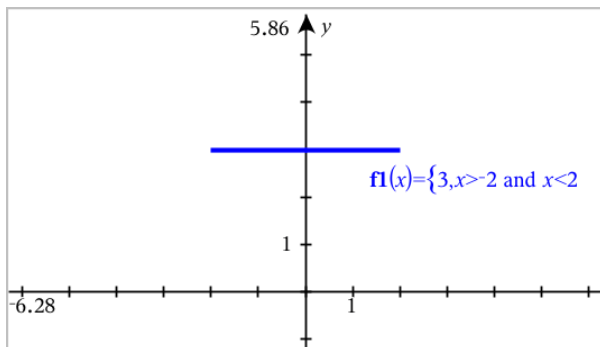

Finding Points of Interest on a Function Graph

The Graphs application helps you find zeros, minimums, maximums, intersections, derivatives (dy/dx), or integrals. For Graphs defined as conic sections, you can also find foci, directrix, and other points.

(CAS): You can also find the point of inflection.

Identifying Points of Interest by Dragging a Point

- ▶ To quickly identify maximums, minimums, and zeros, create a point on the graph and then drag the point.

Temporary signposts appear as you drag through points of interest.

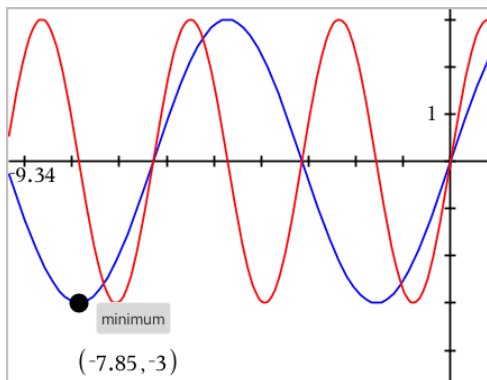

Identifying Points of Interest with Analysis Tools

This example illustrates using the Minimum tool. Other analysis tools operate similarly.

1. From the **Analyze Graph** menu, select **Minimum**.

The Minimum icon is displayed at the top left on the work area, and a **graph?** prompt appears in the work area.

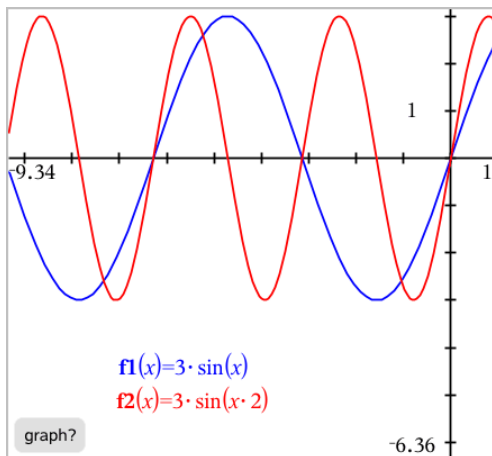

- Click the graph on which you want to find the minimum.

A dotted line appears, representing the lower bound of the range to search.

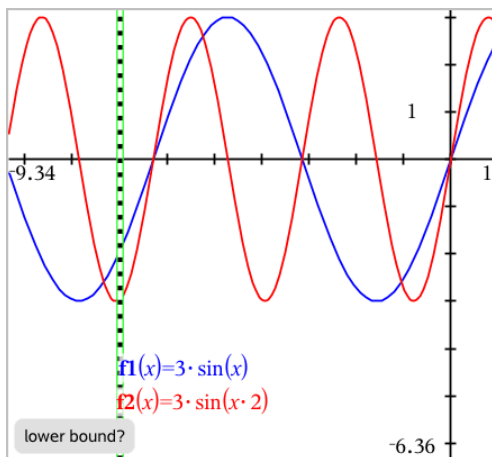

- Drag the line or click a location to set the lower bound and display a proposed upper bound.

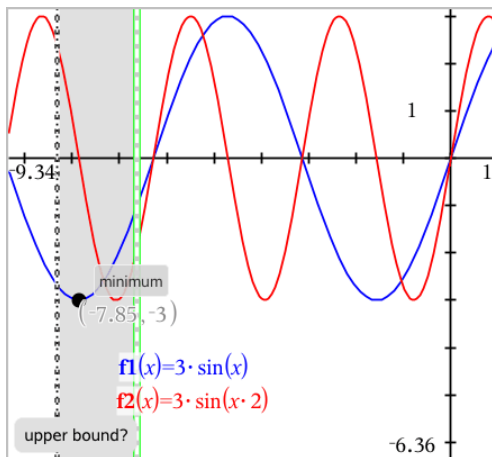

4. Drag the line representing the upper bound, or click a location to set it. The minimum is displayed, along with a text object showing its coordinates.

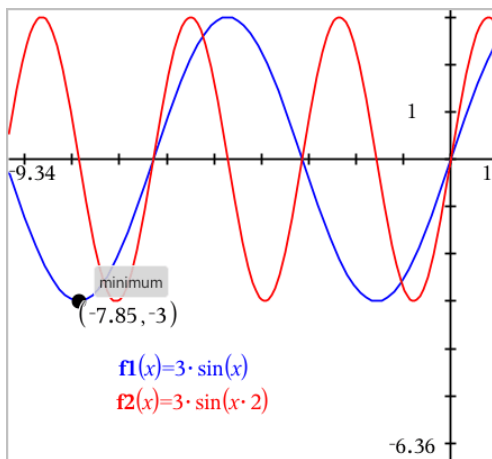

Graphing a Family of Functions

In a family of functions, each member has its own value for one or more of the parameters. By entering the parameters as lists, you can use a single expression to graph a family of up to 16 functions.

For example, the expression $f1(x) = \{-1,0,1,2\} \cdot x + \{2,4,6,8\}$ denotes the following four functions:

$$f1_1(x) = -1 \cdot x + 2$$

$$f1_2(x) = 0 \cdot x + 4$$

$$f1_3(x) = 1 \cdot x + 6$$

$$f1_4(x) = 2 \cdot x + 8$$

To Graph a Family of Functions

1. From the **Graph Entry/Edit** menu, select **Function**.
2. Type the expression, using lists to represent the members of the family.

$$f1(x) = \{-1,0,1,2\} \cdot x + \{2,4,6,8\}$$

3. Press **Enter** to graph the functions.

Each member is labeled separately ($f1_1$, $f1_2$, and so on) to indicate its sequence in the expression.

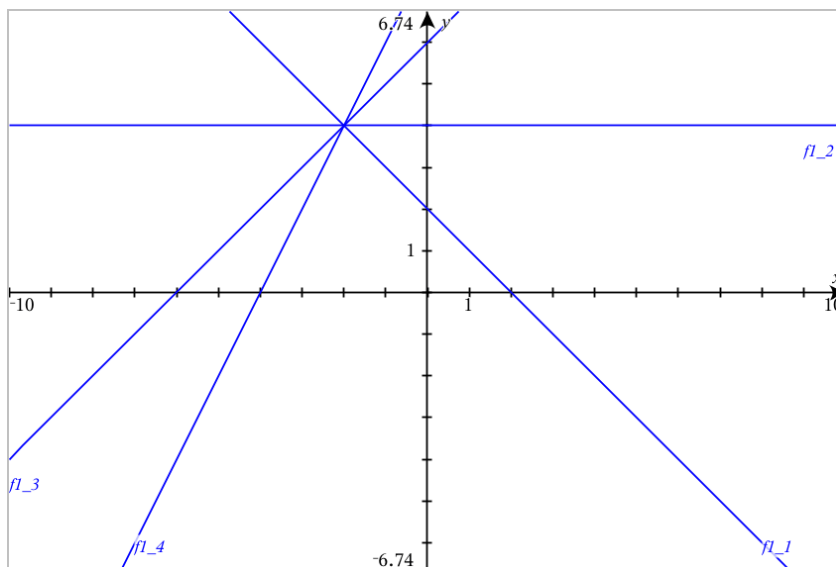

Note: You cannot edit a single function graph to change it to a family of functions.

Graphing Equations

1. From the **Graph Entry/Edit** menu, select **Equation**.
2. Click the type of equation (**Line**, **Parabola**, **Circle**, **Ellipse**, **Hyperbola**, or **Conic**).
3. Click the specific template for the equation. For example, tap $y=a \cdot x^2+b \cdot x+c$ to define a parabola.

The entry line includes a symbol to indicate the type of equation.

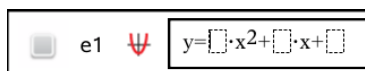

4. Type the coefficients into the equation template.

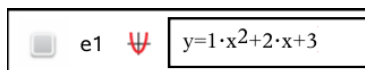

5. Press **Enter**.

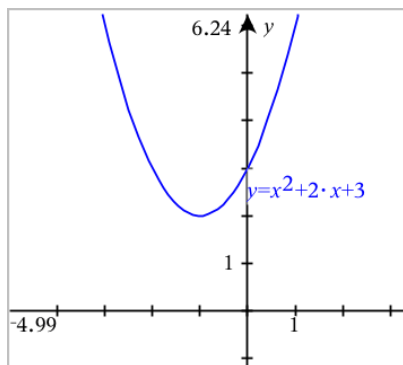

Graphing Conic Sections

The Graphing view lets you graph and explore linear and conic equations analytically in a two-dimensional coordinate system. You can create and analyze lines, circles, ellipses, parabolas, hyperbolas, and general conic equations.

The entry line makes it easy to enter the equation by displaying a template for the type of equation you choose.

Example: Creating a conic ellipse

1. From the **Graph Entry/Edit** menu, select **Equation > Ellipse**, and tap the  equation type.

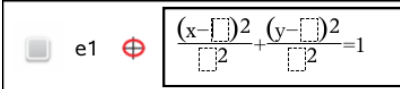

The interface shows a grey square icon labeled 'e1' and a red plus icon. To the right is a template for an ellipse equation: $\frac{(x-\square)^2}{\square^2} + \frac{(y-\square)^2}{\square^2} = 1$. The squares represent input fields for the center coordinates and the semi-axis lengths.

2. Type initial values for the coefficients in the provided spaces. Use the arrow keys to move among the coefficients.

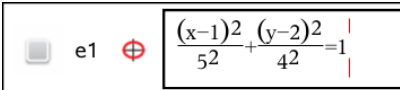

The interface shows the same grey square icon labeled 'e1' and red plus icon. The template now has numerical values entered: $\frac{(x-1)^2}{5^2} + \frac{(y-2)^2}{4^2} = 1$. Red vertical bars are visible on the right side of the equation, indicating the cursor position.

3. Press **Enter** to graph the equation.

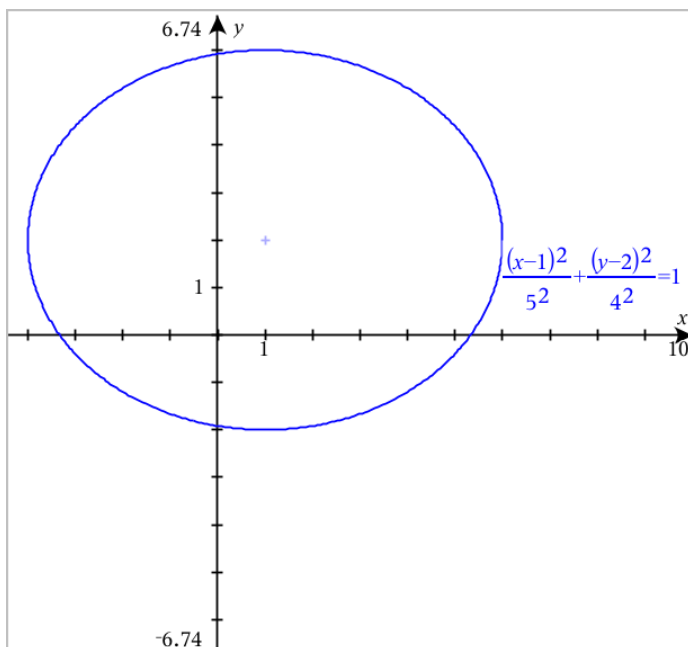

Exploring the sample ellipse

1. Drag the ellipse from its center to explore the effect of translation on the equation.

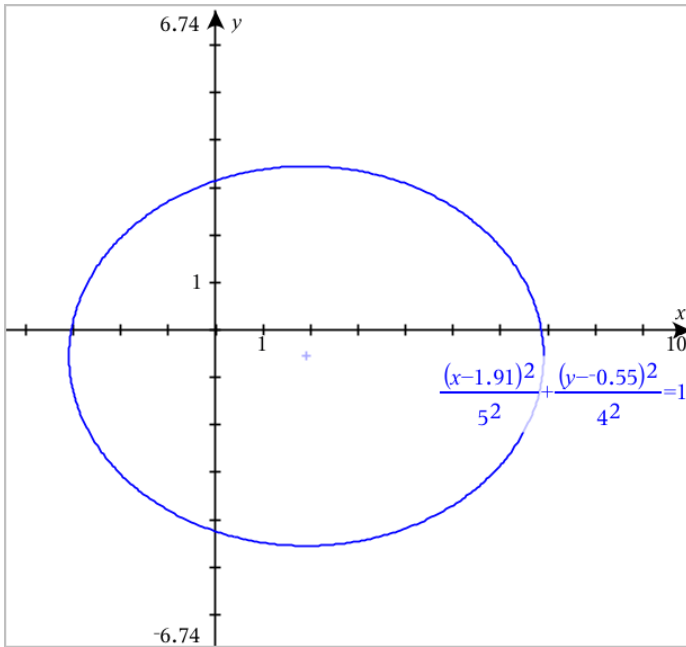

2. Use the analysis tools, such as **Analyze Graph > Analyze Conics > Foci** to further explore the graph.

Note: The type of conic determines which analysis tools you can use. In the case of the ellipse, you can obtain its center, vertices, foci, axes of symmetry, directrices, eccentricity, and latera recta.

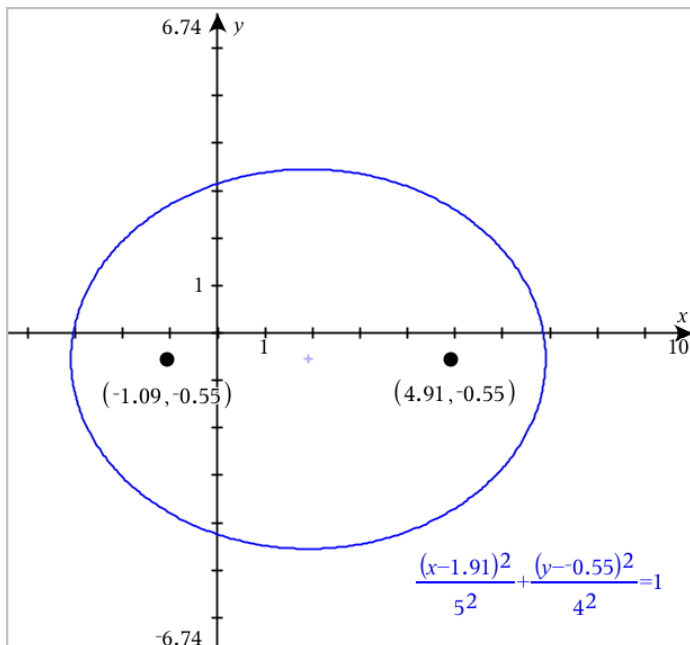

- To explore translation and dilation interactively, define a conic ellipse that uses variables for the h , k , a , and b coefficients. Insert sliders to vary the parameters.

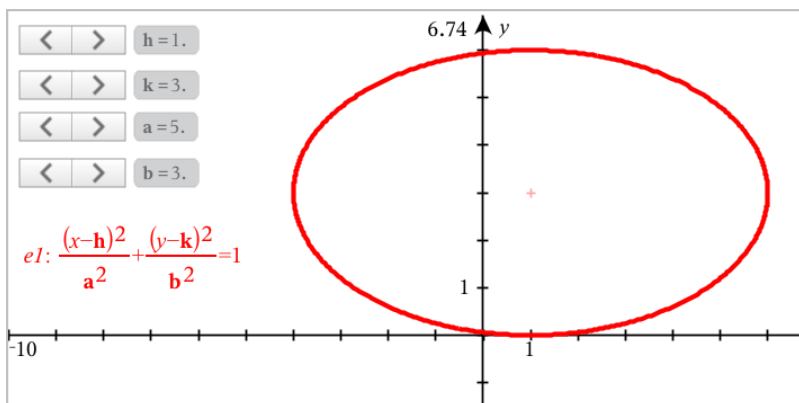

Graphing Parametric Equations

- From the **Graph Entry/Edit** menu, select **Parametric**.

Use the up and down arrow keys to move among the fields in the Parametric entry line.

$$\begin{cases} x1(t)=| \\ y1(t)= \\ 0 \leq t \leq 6.28 \quad tstep=0.13 \end{cases}$$

2. Type expressions for $xn(t)$ and $yn(t)$.

$$\begin{cases} x1(t)=\sin(t) \cdot 4 \\ y1(t)=\cos(t) \cdot 3 \\ 0 \leq t \leq 6.28 \quad tstep=0.13 \end{cases}$$

3. (Optional) Edit the default values for $tmin$, $tmax$, and $tstep$.
4. Press **Enter**.

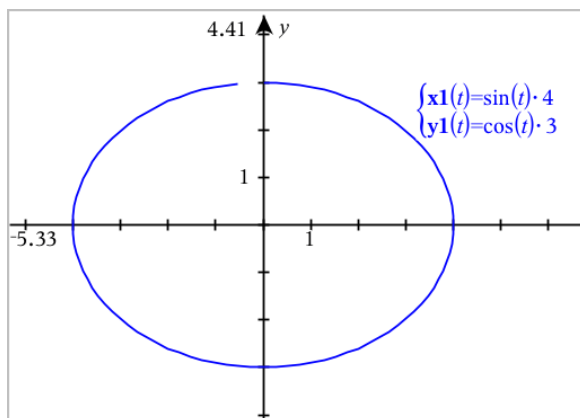

Graphing Polar Equations

1. From the **Graph Entry/Edit** menu, select **Polar**.

$$\begin{cases} r1(\theta)=| \\ 0 \leq \theta \leq 6.28 \quad \thetastep=0.13 \end{cases}$$

2. Type an expression for $rn(\theta)$.
3. (Optional) Edit the default values for θmin , θmax , and $\theta step$.

$$\begin{cases} r1(\theta)=.2 \cdot \theta \\ 0 \leq \theta \leq (\pi \cdot 10) \quad \thetastep=0.13 \end{cases}$$

4. Press **Enter**.

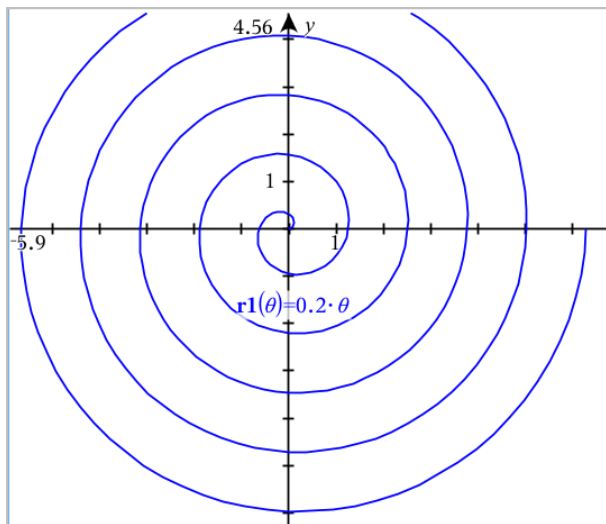

Using the Text Tool to Graph Equations

You can graph an "x=" or "y=" equation by typing it into a text box and dragging the text to an axis. You can edit the equation text (for example, change it to an inequality), but you cannot change it between x= and y=.

Graphing a Trigonometry Relation from Text

1. From the **Actions** menu, select **Text**.
2. Click the work area to place the text box.
3. Type the equation for the trigonometry relation, such as $x=\sin(y) \cdot 2$.

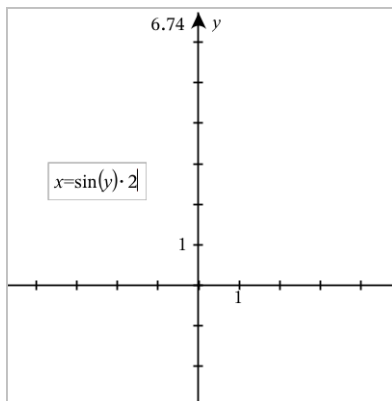

- Press **Enter** to complete the text object.
- Drag the text object to either axis to graph the equation.

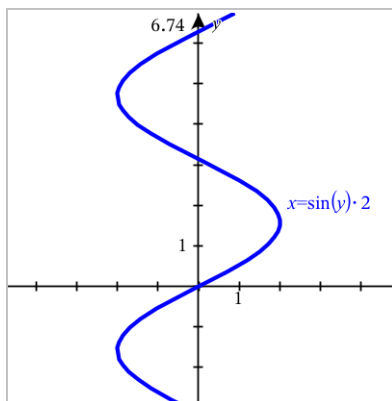

Graphing a Vertical or Horizontal Line from Text

- From the **Actions** menu, select **Text**.
- Click the work area to place the text box.
- Type the equation for a vertical line, such as $x=4$, or a horizontal line, such as $y=-2$. Click **Enter** to complete it.
- Drag the text object to either axis to graph the equation.

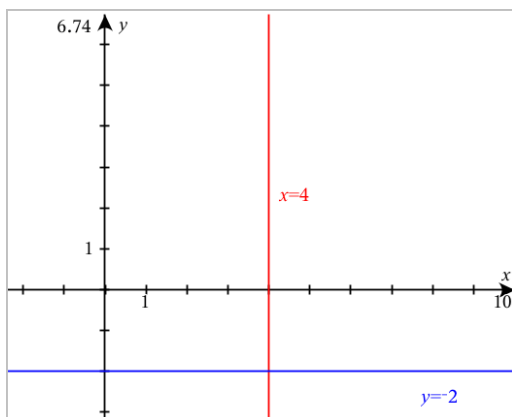

After plotting a line, you can drag to translate or rotate it.

Graphing an Inequality from Text

You can graph inequalities that use the $>$, $<$, \leq , or \geq operators. Areas that satisfy the inequality are shown with shading. If the shaded areas of two or more inequalities overlap, the area of overlap is shaded darker.

1. From the **Actions** menu, select **Text**.
2. Click the work area to place the text box.
3. Type the inequality expression, such as $x < 2 \cdot \sin(y)$. Click **Enter** to complete it.
4. Drag the text object to either axis to graph the inequality.

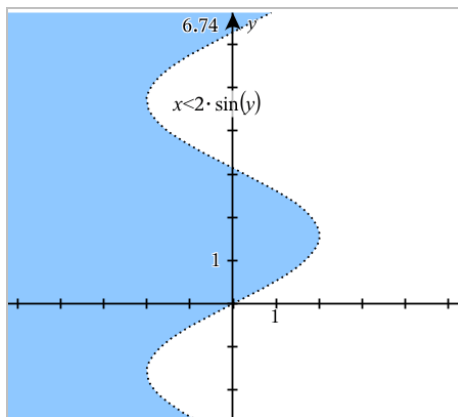

Graphing Scatter Plots

1. (Optional) Create two predefined list variables containing the x and y values to plot. You can use the Lists & Spreadsheet, Calculator, or Notes application to create the lists.

A v1	B v2	C	D
1	2		
2	4		
3	8		
4	16		
5	32		

- From the **Graph Entry/Edit** menu, select **Scatter Plot**.

Use the up and down arrow keys to move between the x and y fields.

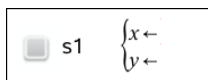

- Use one of the following methods to specify lists to plot as x and y.



- Click **var** to select names of the predefined list variables.
- Type the names of the variables, such as **v1**.
- Type lists as comma-separated elements enclosed within brackets, for example: **{1,2,3}**.

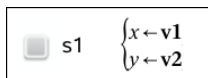

- Press **Enter** to plot the data, and then [zoom the work area](#) to view the plotted data.

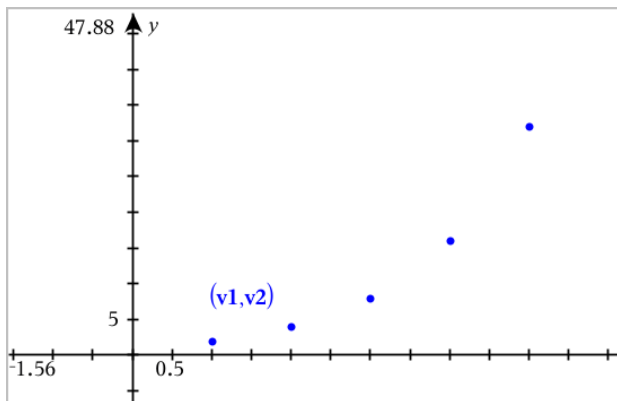

Plotting Sequences

The Graphs application lets you plot two types of sequences. Each type has a separate template for defining the sequence.

Defining a Sequence

- From the **Graph Entry/Edit** menu, select **Sequence > Sequence**.

$$\begin{cases} u1(n)= \\ \text{Initial Terms}:= \\ 1 \leq n \leq 99 \text{ nstep}=1 \end{cases}$$

- Type the expression to define the sequence.
- Type an initial term. If the sequence expression references more than one prior term, such as $u1(n-1)$ and $u1(n-2)$, separate the terms with commas.

$$\begin{cases} u1(n)=1.1 \cdot u1(n-1)+1 \\ \text{Initial Terms}:=1 \\ 1 \leq n \leq 99 \text{ nstep}=1 \end{cases}$$

- Press **Enter**.

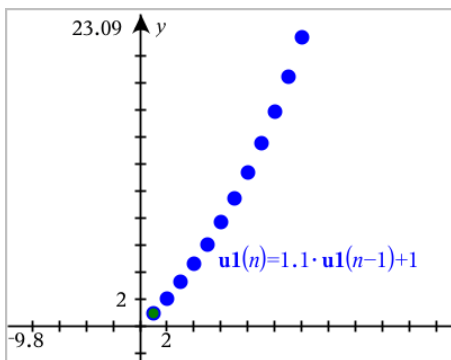

Defining a Custom Sequence

A custom sequence plot shows the relationship between two sequences by plotting one on the x axis and the other on the y axis.

This example simulates the Predator-Prey model from biology.

- Use the relations shown here to [define two sequences](#): one for a rabbit population, and another for a fox population. [Replace the default sequence names](#) with **rabbit** and **fox**.

$$\begin{cases} \text{rabbit}(n)=\text{rabbit}(n-1) \cdot (1+0.05-0.001 \cdot \text{fox}(n-1)) \\ \text{Initial Terms}:=200 \\ 1 \leq n \leq 400 \text{ nstep}=1 \end{cases}$$

$$\begin{cases} \text{fox}(n)=\text{fox}(n-1) \cdot (1+2. \text{E} - 4 \cdot \text{rabbit}(n-1)-0.03) \\ \text{Initial Terms}:=50 \\ 1 \leq n \leq 400 \text{ nstep}=1 \end{cases}$$

.05 = the growth rate of rabbits if there are no foxes
 .001 = the rate at which foxes can kill rabbits
 .0002 = the growth rate of foxes if there are rabbits
 .03 = the death rate of foxes if there are no rabbits

Note: If you want to see the plots of the two sequences, [zoom the window](#) to the **Zoom - Fit** setting.

- From the **Graph Entry/Edit** menu, select **Sequence > Custom**.
- Specify the **rabbit** and **fox** sequences to plot on the x and y axes, respectively.

 p1	$\begin{cases} x \leftarrow \text{rabbit}(n) \\ y \leftarrow \text{fox}(n) \\ 1 \leq n \leq 400 \text{ nstep}=1 \end{cases}$
--	--

- Press **Enter** to create the custom plot.
- [Zoom the window](#) to the **Zoom - Fit** setting.

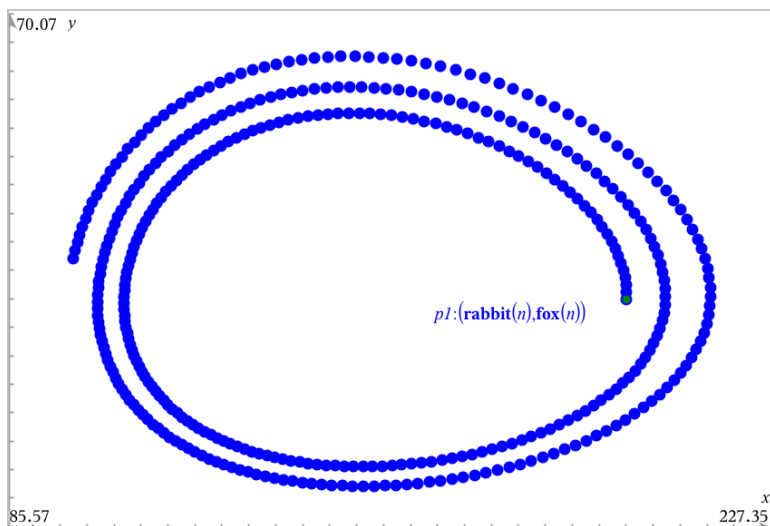

- Explore the custom plot by dragging the point that represents the initial term.

Graphing Differential Equations

You can study linear and non-linear differential equations and systems of ordinary differential equations (ODEs), including logistic models and Lotka-Volterra equations (predator-prey models). You can also plot slope and direction fields with interactive implementations of Euler and Runge-Kutta methods.

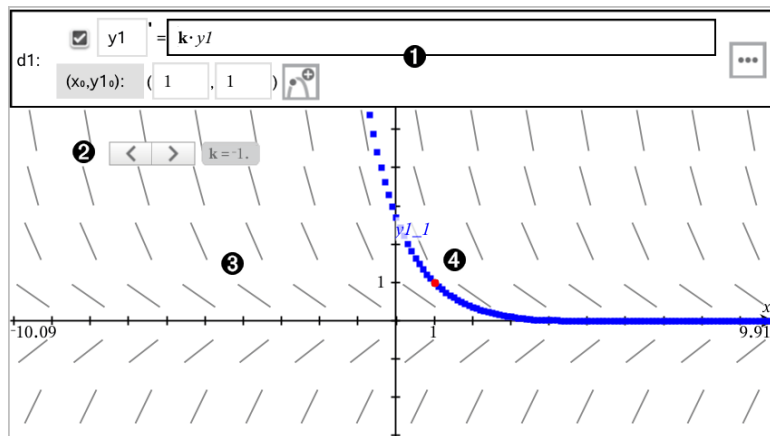

1 ODE entry line:

- **y1** ODE identifier
- Expression **k·y1** defines the relation
- Fields **(1,1)** for specifying initial condition
- Buttons for adding initial conditions and setting plot parameters

2 Slider to vary coefficient **k** of the ODE

3 Slope field

4 A solution curve passing through the initial condition

To Graph a Differential Equation:

1. From the **Graph Entry/Edit** menu, select **Diff Eq.**

The ODE is automatically assigned an identifier, such as “y1.”

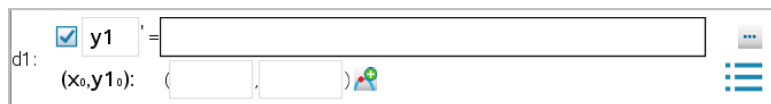

2. Move to the relation field and enter the expression that defines the relation. For example, you might enter $-y_1+0.1 \cdot y_1 \cdot y_2$.



3. Enter the initial condition for the independent value x_0 and for y_{1_0} .
Note: The x_0 value(s) are common to all the ODEs in a problem but can be entered or modified only in the first ODE.
4. (Optional) To study multiple initial conditions for the current ODE, click Add Initial Conditions  and enter the conditions.

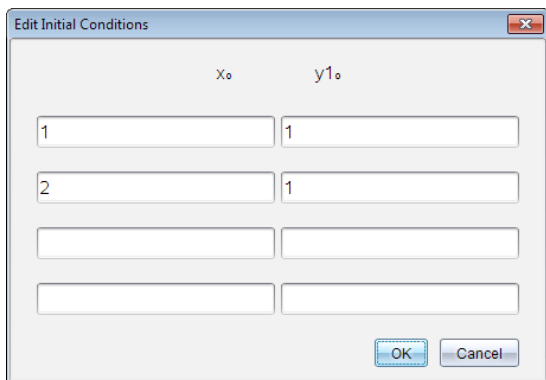

5. Tap Edit Parameters  to set the plot parameters. Select a numerical Solution Method, and then set any additional parameters. You can change these parameters anytime.

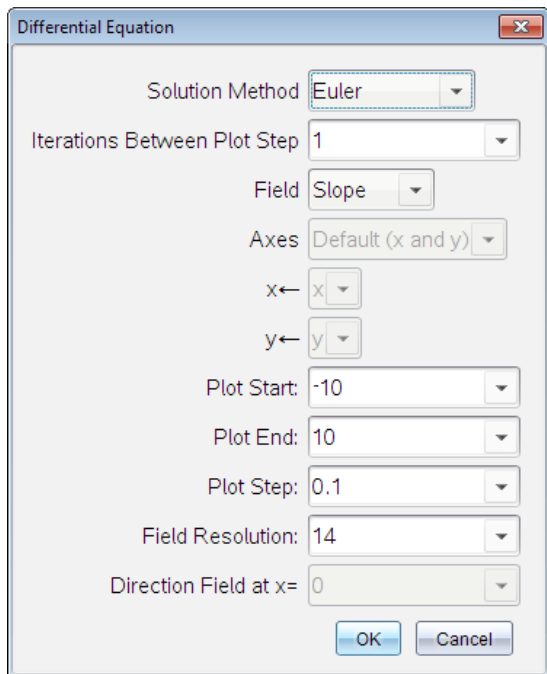

6. Click **OK**.
7. To enter additional ODEs, press the down arrow to display the next ODE edit field.

As you move among defined ODEs, the graph is updated to reflect any changes. One solution to the ODE is graphed for each IC specified for each shown ODE (selected by check box).

Summary of Differential Equation Settings

Solution Method	Selects Euler or Runge-Kutta as the numerical solution method.
Iterations Between Plot Step	Computational accuracy for Euler solution method only. Must be an integer value >0 . To restore the default, select the down arrow and select Default .
Error Tolerance	Computational accuracy for Runge-Kutta solution method only. Must be a floating-point value $\geq 1 \times 10^{-14}$. To restore the default,

select the down-arrow and select **Default**.

Field **None** - No field is plotted. Available for any number of ODEs, but required if three or more 1st-order ODEs are active. Graphs a combination of the solution and/or values of one or more ODEs (according to user-configured **Axes** settings).

Slope - Plots a field representing the family of solutions to a single 1st-order ODE. Exactly one ODE must be active. Sets **Axes** to **Default (x and y)**. Sets Horizontal axis to x (the independent variable). Sets Vertical axis to y (the solution to the ODE).

Direction - Graphs a field in the phase plane representing the relationship between a solution and/or values of a system of two 1st-order ODEs (as specified by the **CustomAxes** setting). Exactly two ODEs must be active.

Axes **Default (x and y)** - Plots x on the x axis and y (the solutions to the active differential equations) on the y axis.

Custom - Lets you select the values to be plotted on the x and y axes respectively. Valid entries include:

- x (the independent variable)
 - y_1 , y_2 , and any identifiers defined in the ODE editor
 - y_1' , y_2' , and any derivatives defined in the ODE editor
-

Plot Start Sets the independent variable value at which the solution plot starts.

Plot End Sets the independent variable value at which the solution plot stops.

Plot Step Sets the increment of the independent variable at which values are plotted.

Field Resolution Sets the number of columns of field rendering elements (line segments) used to draw a slope or direction field. You can change this parameter only if **Field = Direction** or **Slope**.

Direction Field at x= Sets the independent variable value at which a direction field is drawn when plotting non-autonomous equations (those that refer to x). Ignored when plotting autonomous equations. You can change this parameter only if **Field = Direction**.

Viewing Tables from the Graphs Application

You can show a table of values for any relation defined in the current problem.

Note: For details about using tables and instructions for accessing tables from the Lists & Spreadsheet application, see [Working with Tables](#).

Showing a Table

- ▶ From the **Table** menu, select **Split-screen Table**.

The table is displayed with columns of values for the currently defined relations.

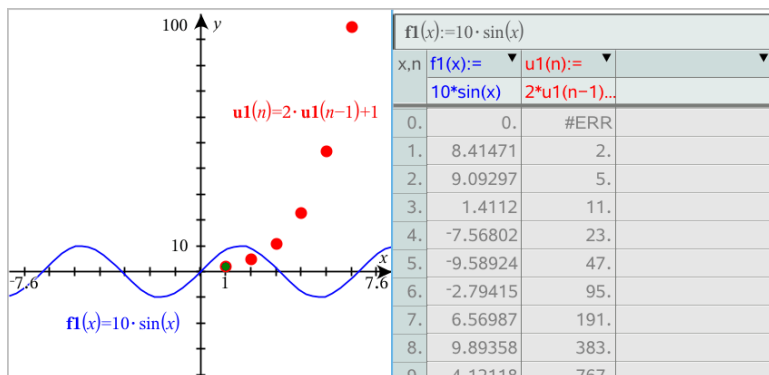

To change which relation is displayed in a column, click the arrow in the top cell of the column, and then select the relation name.

Hiding the Table

- ▶ From the **Table** menu, select **Remove Table**.

Editing Relations

1. Double-click the graph to show its expression in the entry line.
–or–
Display the graph's context menu, and then click **Edit Relation**.

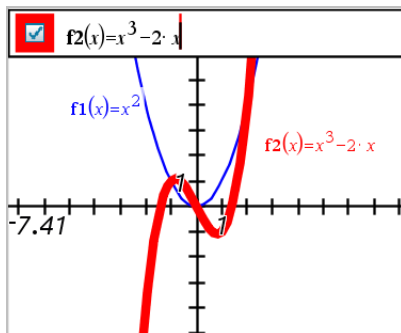

2. Modify the expression as needed.

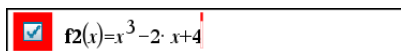

3. Press **enter** to graph the revised function.

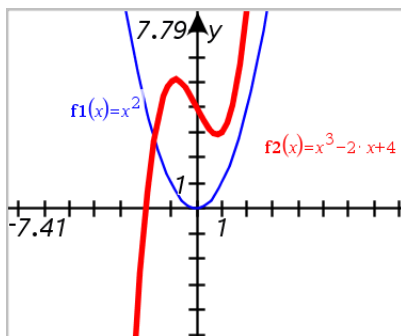

Renaming a Relation

Each relation type has a default naming convention. For example, the default name for functions is $fn(x)$. (The number represented by n increases as you create more functions.) You can replace the default name with a name of your choice.

Note: If you want to use a custom name as a convention, you must enter it manually for each function.

1. In the entry line, delete the existing name. For example, delete the "f1" from "f1(x)". You can use the right and left arrow keys to position the cursor.

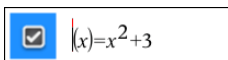

- Type the replacement name.

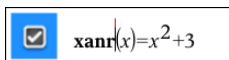

- If you are defining a new relation, position the cursor after the = sign and type the expression.

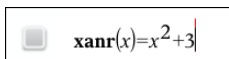

- Press **Enter** to graph the relation with its new name.

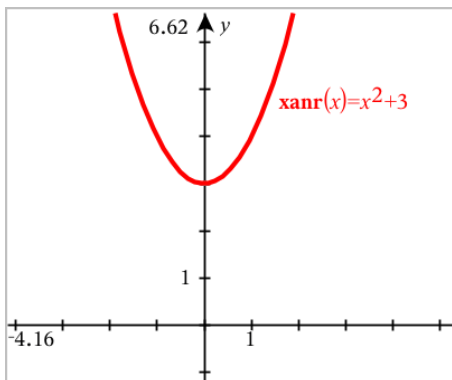

Accessing the Graph History

For each problem, the software stores a history of relations defined in the Graphs application and 3D Graphing view, such as function graphs **f1** through **f99** and 3D function graphs **z1** through **z99**. You can view and edit these items using a button on the entry line.

Viewing the History

- Press **Ctrl+G** to show the entry line.
- Click the **History Menu** button  on the entry line.

The menu is displayed. As you point to the name of each item, its expression appears in the entry line.



- Select the name of the relation you want to view or edit.

4. (Optional) From the entry line, use the up and down arrow keys to scroll through the defined relations of the same type.

Viewing the History of Specific Relation Types

Use this method if you want to view or edit a defined relation that does not appear in the History menu.

1. On the **Graph Entry/Edit** menu, click the relation type. For example, click **Polar** to show the entry line for the next available Polar relation.
2. Click the **History Menu** button , or use the up and down arrow keys to scroll through the defined relations of the same type.

Zooming/Rescaling the Graphs Work Area

Rescaling in the Graphs application affects only the graphs, plots, and objects that reside in the Graphing view. It has no effect on objects in the underlying Plane Geometry view.

- ▶ To rescale the x and y axes proportionally, drag a tic mark on either axis.
- ▶ To rescale only one axis, hold down **Shift** and drag a tic mark on the axis.

Zooming to predefined settings

- ▶ From the **Window/Zoom** menu, select one of the Zoom tools (**Zoom - Box**, **Zoom - In**, or **Zoom - Out**), or select one of the predefined Zoom settings. The initial setting is **Zoom - Standard**.

Entering Custom Window Settings

- ▶ From the **Window/Zoom** menu, select **Window Settings**.

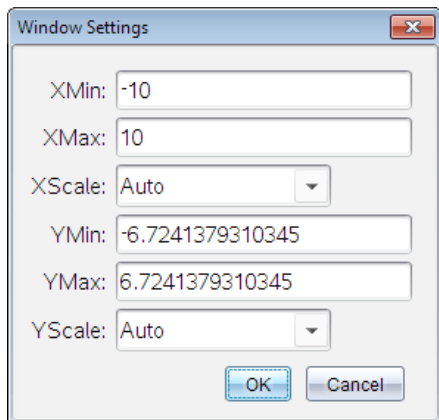

Customizing the Graphs Work Area

Inserting a Background Image

You can [insert an image](#) as a background for any Graphs or Geometry page.

1. From the **Insert** menu, click **Image**.
2. Navigate to the image you want to insert, select it, and then click **Open**.

Adding a Text Object to the Work Area

Use the Text tool to add numeric values, formulas, observations, or other explanatory information to the Graphs work area. You can graph an equation entered as text (such as " $x=3$ ").

1. From the **Actions** menu, select **Text**.
2. Click the location for the text.
3. Type the text in the box that appears, and then press **Enter**.

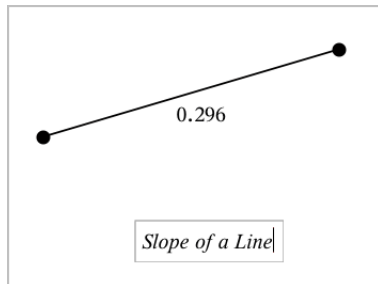

To move a text object, drag it. To edit the text, double-click it. To delete a text object, display its context menu, and select **Delete**.

Changing the Attributes of Numeric Text

If you enter a numeric value as text, you can lock it or set its format and displayed precision.

1. From the **Actions** menu, select **Attributes**.
2. Click the numeric text to display its list of attributes.
3. Press **▲** and **▼** to move through the list.
4. At each attribute icon, press **◀** or **▶** to move through the options. For example, select **0** through **9** as the precision.
5. Press **Enter** to apply the changes.
6. Press **Esc** to close the Attributes tool.

Displaying the Grid

By default, the grid is not displayed. You can choose to display it as dots or lines.

- ▶ From the **View** menu, select **Grid**, and then select **Dot Grid**, **Lined Grid**, or **No Grid**.

Changing the Grid Color

1. From the **Actions** menu, choose **Select > Grid** (available only when the grid is displayed).

The grid flashes to show it is selected.

2. Click the down arrow next to the Color button, and select a color for the grid.



Changing the Appearance of the Graph Axes

1. From the **Actions** menu, click **Attributes**.

- Click either axis.
- Press ▲ and ▼ to move to the desired attribute, and then press ◀ and ▶ to choose the option to apply.

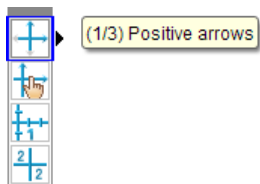

Note: To hide the axes or selectively hide or show an individual axis end-value, use the [Hide/Show tool](#).

Hiding and Showing Items in the Graphs Application

The Hide/Show tool reveals objects you have previously selected as hidden and lets you select which objects to show or hide.

Note: If you hide a graph, its expression is automatically marked as hidden in the [graph history](#).

- From the **Actions** menu, select **Hide/Show**.

The Hide/Show tool appears at the top of the work area, and currently hidden items (if any) are shown dimmed.

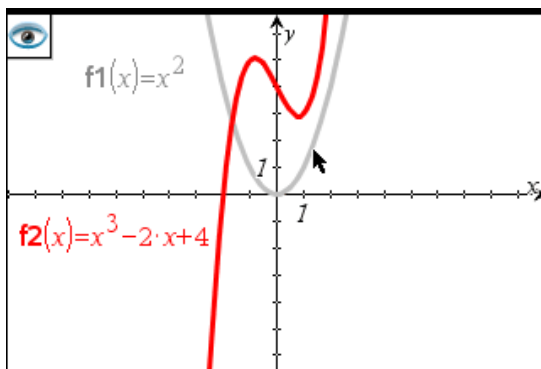

- Click objects to toggle their hide/show status. You can hide graphs, geometric objects, text, labels, measurements, and individual axis end-values.
- Press **Esc** to complete your selections and close the tool.

All objects you selected as hidden objects disappear.

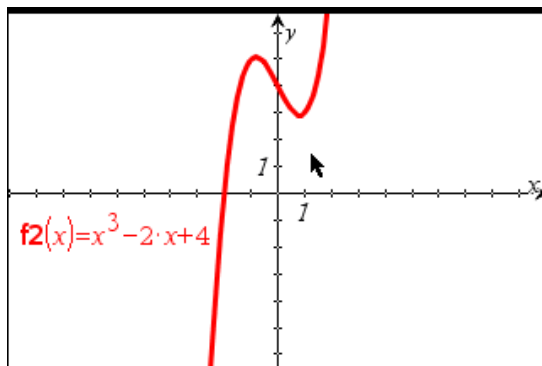

4. To view the hidden objects temporarily or restore them as shown objects, open the Hide/Show tool.

Conditional Attributes

You can cause objects to hide, show, and change color dynamically, based on specified conditions such as " $r_1 < r_2$ " or " $\sin(a_1) \geq \cos(a_2)$."

For example, you might want to hide an object based on a changing measurement that you have assigned to a variable, or you might want an object's color to change based on a "Calculate" result assigned to a variable.

Conditional behaviors can be assigned to objects or groups in the Graphing, Plane Geometry, and 3D Graphing views.

Setting Conditional Attributes of an Object

You can set conditions of a selected object either by using its context menu or by activating the Set Conditions tool from the **Actions** menu and then selecting the object. These instructions describe using the context menu.

1. Select the object or group.
2. Display the object's context menu, and click **Conditions**.

The conditional attributes are displayed.

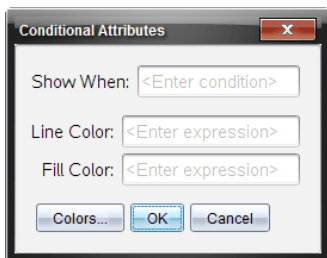

For 2D objects

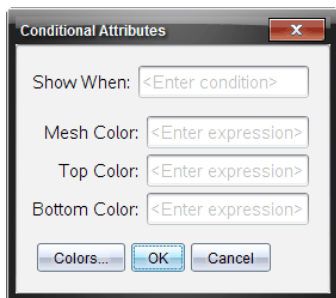

For 3D objects

- (Optional) In the **Show When** field, enter an expression specifying the conditions during which the object will be shown. Anytime the condition is not satisfied, the object will be hidden.

You can specify tolerance by using compound conditionals in the **Show When** input field. For example, **area>=4 and area<=6**.

Note: If you need to see conditionally hidden objects temporarily, click **Actions > Hide/Show**. To return to normal viewing, press **ESC**.

- (Optional) Enter numbers or expressions that evaluate to numbers in the applicable color fields, such as **Line Color** or **Mesh Color**. To see a map of color values, click the **Colors** button.

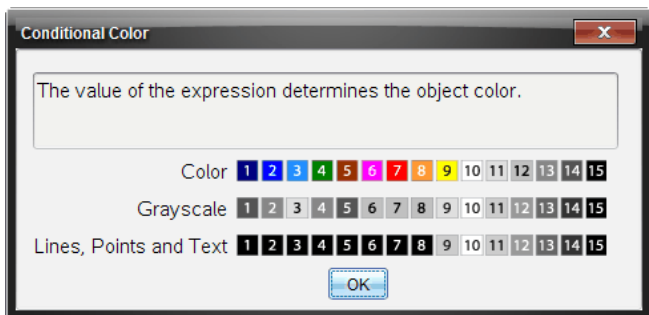

Map of conditional color values

- Click **OK** in the Conditional Attributes dialog box to apply the conditions.

Calculating Area Between Curves

Note: To avoid unexpected results when using this feature, make sure the [document setting](#) for "Real or Complex Format" is set to **Real**.

When you calculate the area between curves, each curve must be:

- A function with respect to x .
- or -
- An equation in the form $y=$, including $y=$ equations defined through a text box or a conic equation template.

Defining and Shading the Area

1. From the **Analyze Graph** menu, select **Bounded Area**.

If only two appropriate curves are available, they are selected automatically. Otherwise, you are prompted to select both curves.

2. Click each curve to select it.

You are prompted to set the lower and upper bounds.

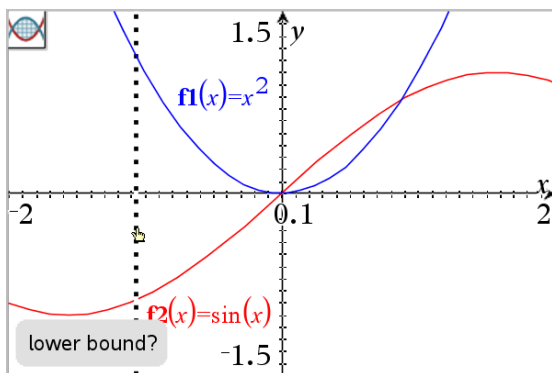

3. Click two points to define the bounds. Optionally, you can type numeric values.

The area becomes shaded, and the area value is displayed. The value is always non-negative, regardless of the interval direction.

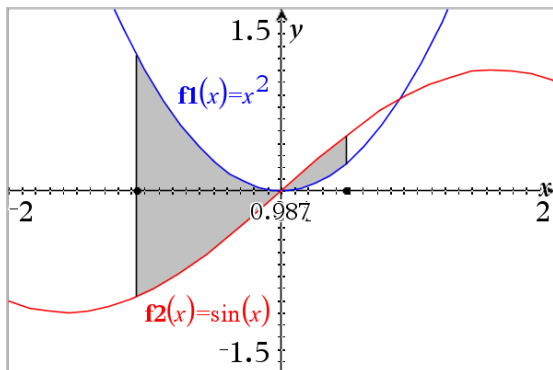

Working with Shaded Areas

As you change the bounds or redefine the curves, the shading and the area value are updated .

- To change the lower or upper bound, drag it or type new coordinates for it. You cannot move a bound that resides on an intersection. However, the point moves automatically as you edit or manipulate the curves.
- To redefine a curve, either manipulate it by dragging or edit its expression in the entry line.

If an endpoint resided originally on an intersection, and the redefined functions no longer intersect, the shading and area value disappear. If you redefine the function(s) so that there is an intersection point, the shading and area value reappear.

- To delete or hide the shaded area, or to change its color and other attributes, display its context menu.
 - Windows®: Right-click the shaded area.
 - Mac®: Hold \mathcal{X} and click the shaded area.
 - Handheld: Move the pointer to the shaded area and press ctrl .

Tracing Graphs or Plots

Graph Trace lets you move a trace cursor over the points of a graph or plot and displays value information.

Tracing Specific Graphs

1. From the **Trace** menu, select **Graph Trace**.

The Graph Trace tool appears at the top of the work area, the trace cursor appears, and the cursor coordinates are displayed in the lower right corner.

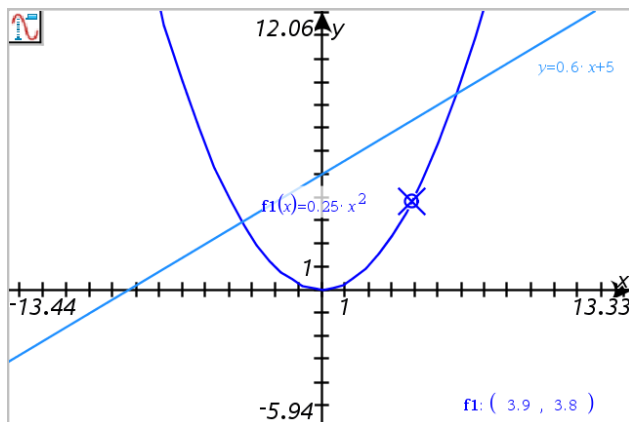

2. Explore a graph or plot:

- Point to a position on a graph or plot to move the trace cursor to that point.
- Press ◀ or ▶ to step the cursor along the current graph or plot. The screen pans automatically to keep the cursor in view.
- Press ▲ or ▼ to cycle among the displayed graphs.
- Click the trace cursor to create a persistent point. Optionally, enter a specific independent value to move the trace cursor to that value.

3. To stop tracing, press **Esc**.

Tracing All Graphs

The Trace All tool allows tracing multiple functions simultaneously. With several functions graphed on the work area, perform the following steps:

Note: The Trace All tool traces only function graphs, not plots of other relations (polar, parametric, scatter, sequence).

1. From the **Trace** menu, select **Trace All**.

The Trace All tool appears in the work area, a vertical line indicates the x value of the trace, and the coordinates for each traced point are displayed in the lower right corner.

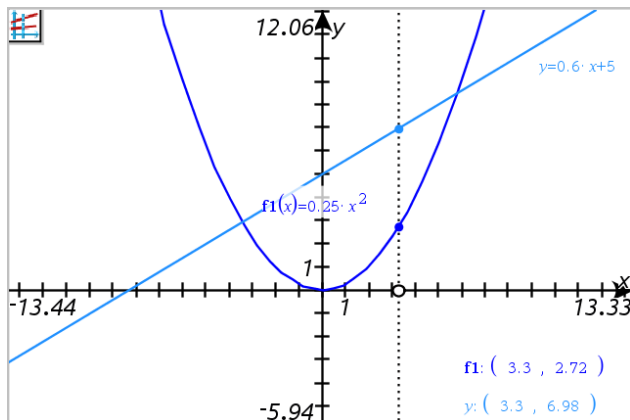

2. Explore the graphs:
 - Click a point on the x axis to move all the trace points to that x value.
 - Press ◀ or ▶ to step the trace points along all the graphs.
3. To stop tracing, press **Esc**.

Changing the Trace Step

1. From the **Trace** menu, select **Trace Step**.

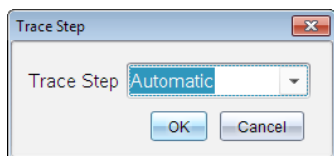

2. Choose Automatic or enter a specific step size for tracing.

Introduction to Geometric Objects

Geometry tools are accessible in both the Graphs and Geometry applications. You can use these tools to draw and investigate objects such as points, lines, and shapes.

- The Graphing view shows the Graphs work area superimposed on the Geometry work area. You can select, measure, and alter objects in both work areas.
- The Plane Geometry view shows only the objects created in the Geometry application.

Objects Created in the Graphs Application

Points, lines, and shapes created in the Graphs application are analytic objects.

- All points that define these objects reside on the x,y graph plane. Objects created here are visible only in the Graphs application. Changing the axes scale affects the appearance of the objects.
- You can display and edit the coordinates of any point on an object.
- You can display the equation of a line, tangent line, circle shape, or geometric conic created in the Graphs application.

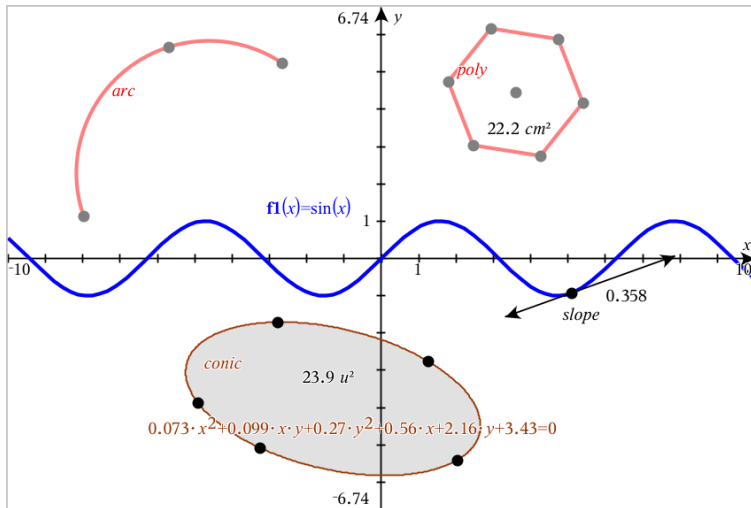

The circle arc and polygon were created in the Geometry application. The sine wave and conic were created in the Graphs application.

Objects Created in the Geometry Application

Points, lines, and shapes created in the Geometry application are not analytic objects.

- Points that define these objects do not reside on the graph plane. Objects created here are visible in both the Graphs and Geometry applications, but they are unaffected by changes to the Graphs x,y axes.
- You cannot obtain the coordinates of an object's points.
- You cannot display the equation of a geometric object created in the Geometry application

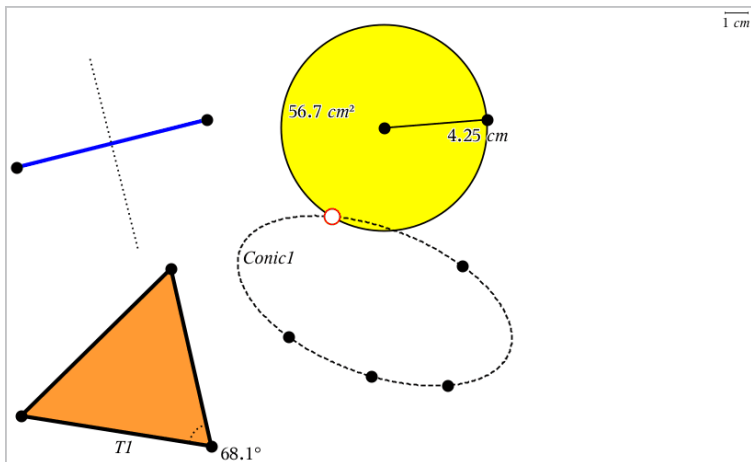

Creating Points and Lines

As you create an object, a tool appears in the work area (for example, **Segment** ). To cancel, press **ESC**.

Creating a Point on the Work Area

1. From the **Points and Lines** menu, select **Point**. (In the Graphs application, click **Geometry > Points and Lines > Point**.)
2. Click a location to create the point.
3. (Optional) Label the point.
4. To move a point, drag it.

Creating a Point on a Graph or Object

You can create a point on a line, segment, ray, axis, vector, circle, graph, or axis.

1. From the **Points and Lines** menu, select **Point On**. (In the Graphs application, click **Geometry > Points and Lines > Point On**.)
2. Click the graph or object on which you want to create the point.
3. Click a location on the object to place the point.

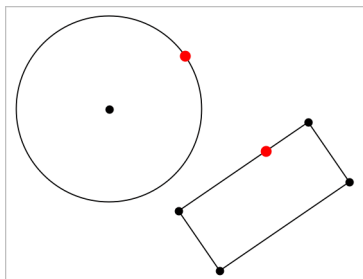

Identifying Points of Intersection

1. From the **Points and Lines** menu, select **Intersection Points**. (In the Graphs application, click **Geometry > Points and Lines > Intersection Points**.)
2. Click two intersecting objects to add points at their intersections.

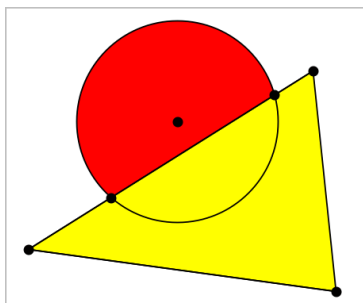

Creating a Line

1. From the **Points and Lines** menu, select **Line**. (In the Graphs application, click **Geometry > Points and Lines > Line**.)
2. Click a location to define one point on the line.
3. Click a second location to define the direction of the line and the length of its visible portion.

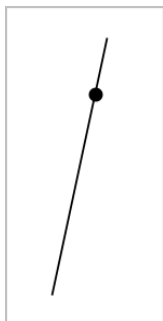

4. To move a line, drag its identifying point. To rotate it, drag any point except the identifying point or ends. To extend its visible portion, drag from either end.

Creating a Segment

1. From the **Points and Lines** menu, select **Segment**. (In the Graphs application, click **Geometry > Points and Lines > Segment**.)
2. Click two locations to define the endpoints of the segment.



3. To move a segment, drag any point other than an endpoint. To manipulate the direction or length, drag either endpoint.

Creating a Ray

1. From the **Points and Lines** menu, select **Ray**. (In the Graphs application, click **Geometry > Points and Lines > Ray**.)
2. Click a location to define the endpoint of the ray.
3. Click a second location to define the direction.



To move a ray, drag its identifying point. To rotate it, drag any point except the identifying point or end. To extend its visible portion, drag from the end.

Creating a Tangent

You can create a tangent line at a specific point on a geometric object or function graph.

1. From the **Points and Lines** menu, select **Tangent**. (In the Graphs application, click **Geometry > Points and Lines > Tangent**.)
2. Click the object to select it.
3. Click a location on the object to create the tangent.

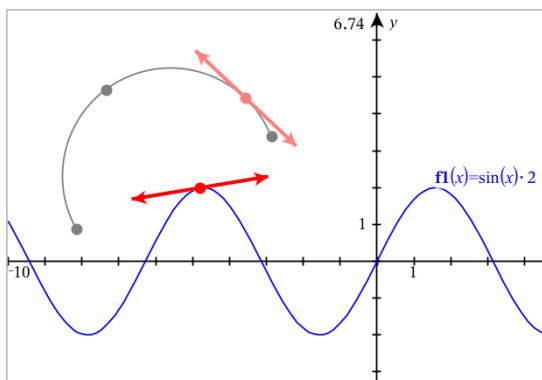

4. To move a tangent, drag it. It remains attached to the object or graph.

Creating a Vector

1. From the **Points and Lines** menu, select **Vector**. (In the Graphs application, click **Geometry > Points and Lines > Vector**.)

- Click a location to establish the vector's initial point.
- Click a second location to specify direction and magnitude and complete the vector.

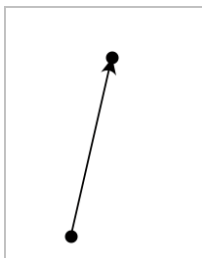

- To move a vector, drag any point other than the endpoints. To manipulate the magnitude and/or direction, drag either end point.

Note: If you create an endpoint on an axis or another object, you can move the endpoint only along that object.

Creating a Circle Arc

- From the **Points and Lines** menu, select **Circle Arc**. (In the Graphs application, click **Geometry > Points and Lines > Circle Arc**.)
- Click a location or point to establish the starting point of the arc.
- Click a second point to establish an intermediate point through which the arc will pass.
- Click a third point to set the ending point and complete the arc.

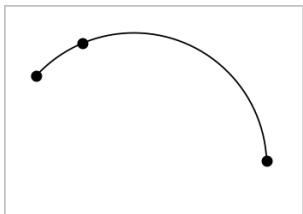

- To move an arc, drag its perimeter. To manipulate it, drag any of its three defining points.

Creating Geometric Shapes

The Shape tools let you explore circles, polygons, conics, and other geometric objects.

As you create a shape, a tool appears in the work area (for example, **Circle** ). To cancel the shape, press **ESC**.

Creating a Circle

1. From the **Shapes** menu, select **Circle**. (In the Graphs application, click **Geometry > Shapes > Circle**.)
2. Click a location or point to position the circle's center point.
3. Click a location or point to establish the radius and complete the circle.

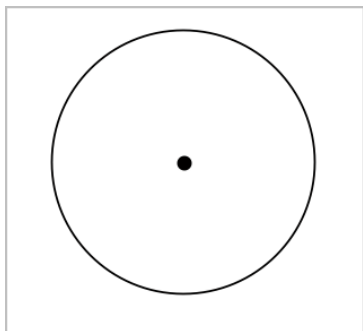

4. To resize a circle, drag its perimeter. To move it, drag its center point.

Creating a Triangle

1. From the **Shapes** menu, select **Triangle**. (In the Graphs application, click **Geometry > Shapes > Triangle**.)
2. Click three locations to establish the vertices of the triangle.

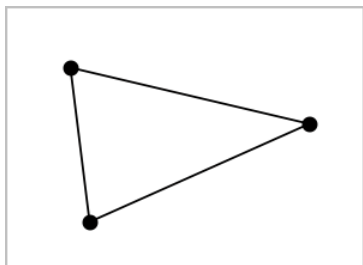

3. To manipulate a triangle, drag any point. To move it, drag any side.

Creating a Rectangle

1. From the **Shapes** menu, select **Rectangle**. (In the Graphs application, click **Geometry > Shapes > Rectangle**.)
2. Click a location or point to establish the first corner of the rectangle.
3. Click a location for the second corner.
One side of the rectangle is displayed.
4. Click to establish the distance to the opposite side and complete the rectangle.

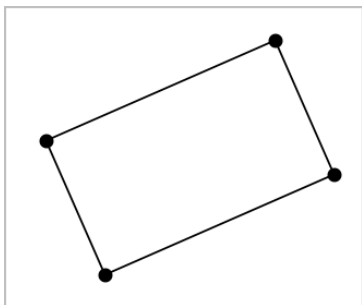

5. To rotate a rectangle, drag one of its first two points. To extend it, drag one of the last two points. To move it, drag any side.

Creating a Polygon

1. From the **Shapes** menu, select **Polygon**. (In the Graphs application, click **Geometry > Shapes > Polygon**.)
2. Click a location or point to establish the first vertex of the polygon.
3. Click to establish each additional vertex.
4. To complete the polygon, click the first vertex.

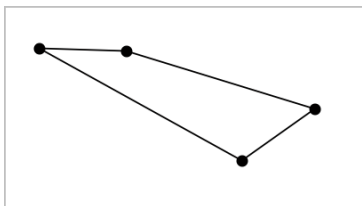

- To manipulate a polygon, drag any vertex. To move it, drag any side.

Creating a Regular Polygon

- From the **Shapes** menu, select **Regular Polygon**. (In the Graphs application, click **Geometry > Shapes > Regular Polygon**.)
- Click once on the work area to establish the center point.
- Click a second location to establish the first vertex and radius.

A 16-sided regular polygon is formed. The number of sides is displayed in brackets; for example, {16}.

- Drag any vertex in a circular motion to set the number of sides.
 - Drag clockwise to reduce the number of sides.
 - Drag counterclockwise to add diagonals.

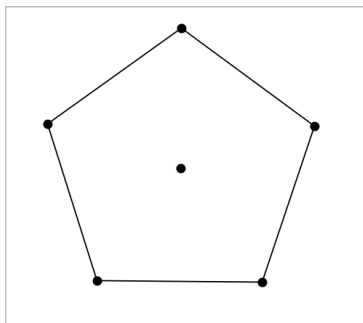

- To resize or rotate a regular polygon, drag any of its points. To move it, drag any side.

Creating an Ellipse

- From the **Shapes** menu, select **Ellipse**. (In the Graphs application, click **Geometry > Shapes > Ellipse**.)
- Click two locations or points to establish the foci.
- Click to establish a point on the ellipse and complete the shape.

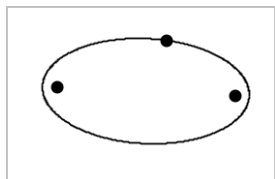

4. To manipulate an ellipse, drag any of its three defining points. To move it, drag its perimeter.

Creating a Parabola (from focus and vertex)

1. From the **Shapes** menu, select **Parabola**. (In the Graphs application, click **Geometry > Shapes > Parabola**.)
2. Click a location to establish the focus.
3. Click a location to establish the vertex and complete the parabola.

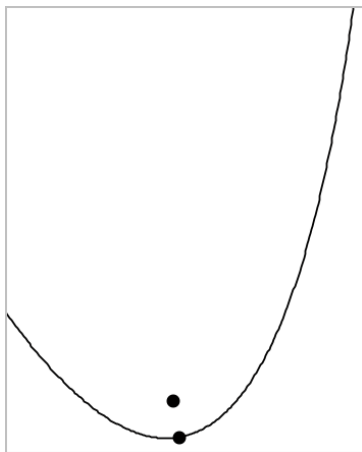

4. To manipulate a parabola, drag its focus or its vertex. To move it, drag it from any other point.

Creating a Parabola (from focus and directrix)

1. Create a line to serve as the directrix.
2. From the **Shapes** menu, select **Parabola**. (In the Graphs application, click **Geometry > Shapes > Parabola**.)
3. Click a location to establish the focus.
4. Click the line to establish it as the directrix.

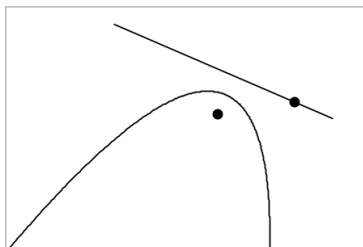

5. To manipulate a parabola, rotate or move its directrix or drag its focus. To move it, select both the directrix and the focus, and then drag either object.

Creating a Hyperbola

1. From the **Shapes** menu, select **Hyperbola**. (In the Graphs application, click **Geometry > Shapes > Hyperbola**.)
2. Click two locations to establish the foci.
3. Click a third location to complete the hyperbola.

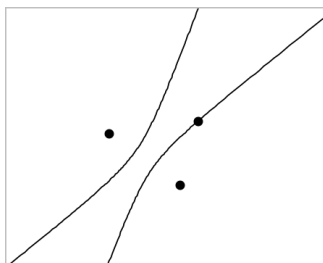

4. To manipulate a hyperbola, drag any of its three defining points. To move it, drag it from any other place on the shape.

Creating a Conic by Five Points

1. From the **Shapes** menu, select **Conic by Five Points**. (In the Graphs application, click **Geometry > Shapes > Conic by Five Points**.)
2. Click five locations to establish the five points on the shape.
Depending on the pattern of the points, the conic can be a hyperbola or an ellipse.

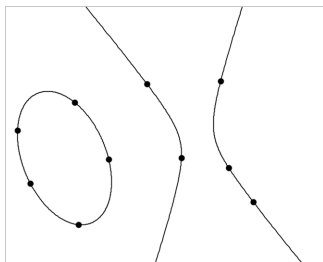

3. To manipulate a conic, drag any of its five defining points. To move it, drag it from any other place on the shape.

Basics of Working with Objects

Selecting and Deselecting Objects

You can select an individual object or multiple objects. Select multiple objects when you want to quickly move, color, or delete them together.

1. Click an object or graph to select it.
The object flashes to indicate selection.
2. Click any additional objects to add them to the selection.
3. Perform the operation (such as moving or setting color).
4. To deselect all objects, click an empty space in the work area.

Grouping and Ungrouping Geometric Objects

Grouping objects gives you a way to reselect them as a set, even after you have deselected them to work with other objects.

1. Click each object to add it to the current selection.
The selected objects flash.
2. Display a context menu of the selected object or objects.
3. Click **Group**. You can now select all the items in the group by clicking any of its members.
4. To split a group into individual objects, display a context menu of any of its member objects, and click **Ungroup**.

Deleting Objects

1. Display the context menu of the object or objects.
2. Click **Delete**.

You cannot delete the origin, the axes, or points representing locked variables, even if those items are included in the selection.

Moving Objects

You can move an object, group, or combination of selected objects and groups.

Note: If an immovable object (such as the graph axes or a point with locked coordinates) is included in a selection or group, you cannot move any of the objects. You must cancel the selection and then select only movable items.

To move this...	Drag this
A multiple-object selection or group	Any of its objects
A point	The point
A segment or vector	Any point other than an endpoint
A line or ray	The identifying point
A circle	The center point
Other geometric shapes	Any position on the object except one of its defining points. For example, move a polygon by dragging any of its sides.

Constraining Object Movement

Holding down the **SHIFT** key before dragging lets you constrain how certain objects are drawn, moved, or manipulated.

Use the constraint feature to:

- Rescale only a single axis in the Graphs application.

- Pan the work area horizontally or vertically, depending on which direction you drag initially.
- Limit object movement to horizontal or vertical.
- Limit point placement to 15° increments as you draw a triangle, rectangle, or polygon.
- Limit angle manipulations to 15° increments.
- Limit the radius of a resized circle to integer values.

Pinning Objects

Pinning objects prevents accidental changes as you move or manipulate other objects.

You can pin graphed functions, geometric objects, text objects, the graph axes, and the background.

1. Select the object or objects to pin, or click an empty area if you are pinning the background.
2. Display the context menu, and select **Pin**.

A pinned object displays a pin icon  when you point to it.

3. To unpin an object, display its context menu, and select **Unpin**.

Notes:

- Although you cannot drag a pinned point, you can reposition it by editing its x and y coordinates.
- You cannot pan the work area while the background is pinned.

Changing the Line or Fill Color of an Object

Color changes made in the software are displayed in shades of gray when you work on documents using a TI-Nspire™ handheld that does not support color. Color is preserved when you move documents back to the software.

1. Select the object or objects.
2. Display the object's context menu, click **Color**, and then click **Line Color** or **Fill Color**.
3. Select the color to apply to the objects.

Changing the Appearance of an Object

1. From the **Actions** menu, select **Attributes**.
2. Click the object that you want to change. You can change shapes, lines, graphs, or graph axes.

The list of the attributes for the selected object are displayed.

3. Press **▲** and **▼** to move through the list of attributes.
4. At each attribute icon, press **◀** or **▶** to move through the options. For example, select **Thick**, **Thin**, or **Medium** for the **Line Weight** attribute.
5. Press **Enter** to apply the changes.
6. Press **ESC** to close the **Attributes** tool.

Labeling Points, Geometric Lines, and Shapes

1. Display the context menu of the object.
2. Click **Label**.
3. Type the text of the label, and then press **Enter**.

The label attaches itself to the object and follows the object as you move it. The label's color matches the object's color.

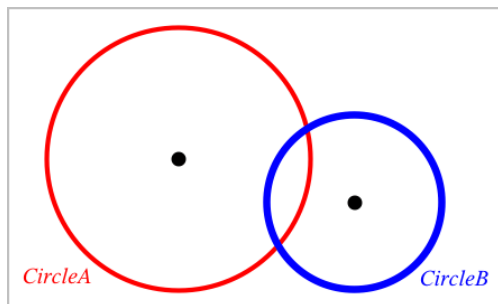

Measuring Objects

Measurement values update automatically as you manipulate the measured object.

Note: Measurements of objects created in the **Graphs** application are displayed in generic units named *u*. Measurements of objects created in the **Geometry** application are displayed in centimeters (*cm*).

Measuring Length of a Segment, Circle Arc, or Vector

1. From the **Measurement** menu, select **Length**. (In the Graphs application, click **Geometry > Measurement > Length**.)
2. Click the object to display its length.

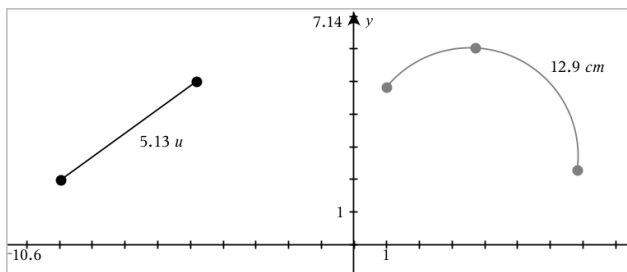

Measuring Distance Between Two Points, a Point and a Line, or a Point and a Circle

1. From the **Measurement** menu, select **Length**. (In the Graphs application, click **Geometry > Measurement > Length**.)
2. Click the first point.
3. Click the second point or a point on the line or circle.

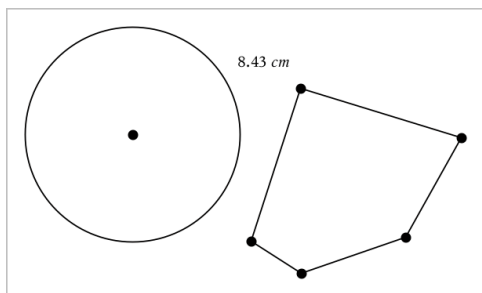

In this example, length is measured from the center of the circle to the upper left vertex of the polygon.

Measuring Circumference of a Circle or Ellipse or the Perimeter of a Polygon, Rectangle, or Triangle

1. From the **Measurement** menu, select **Length**. (In the Graphs application, click **Geometry > Measurement > Length**.)

- Click the object to display its circumference or perimeter.

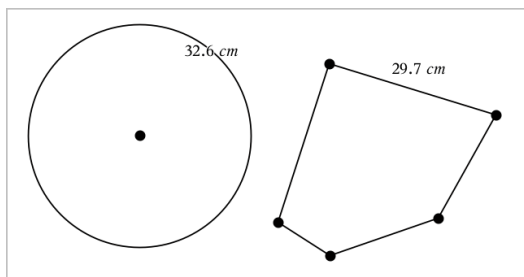

Measuring a Side of a Triangle, Rectangle, or Polygon

- From the **Measurement** menu, select **Length**. (In the Graphs application, click **Geometry > Measurement > Length**.)
- Click two points on the object that form the side you want to measure.

Note: You must click *two points* to measure a side. Clicking the side measures the entire length of the object's perimeter.

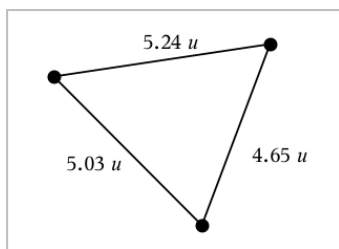

Measuring Area of a Circle, Ellipse, Polygon, Rectangle, or Triangle

Note: You cannot measure the area of a polygon constructed using the Segment tool.

- From the **Measurement** menu, select **Area**. (In the Graphs application, click **Geometry > Measurement > Area**.)
- Click the object to display its area.

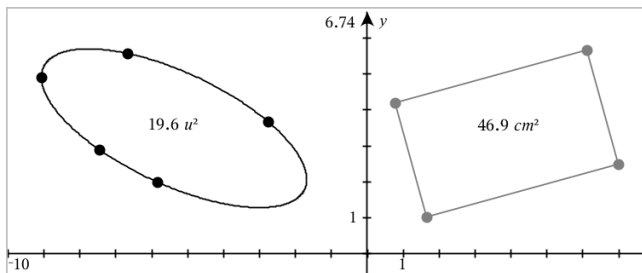

Measuring Slope of a Line, Ray, Segment, or Vector

1. From the **Measurement** menu, select **Slope**. (In the Graphs application, click **Geometry > Measurement > Slope**.)
2. Click the object to display its slope.

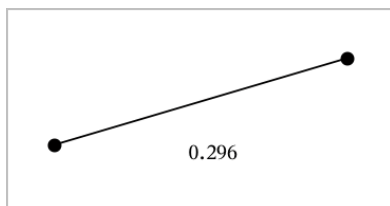

The value is updated automatically when you manipulate the object.

Measuring Angles

Measured angles in the Geometry application range from 0° to 180° . Measured angles in the Graphs application range from 0 radians to π radians. To change the angle unit, use the **Settings** menu.

1. From the **Measurement** menu, select **Angle**. (In the Graphs application, click **Geometry > Measurement > Angle**.)
2. Click three locations or points to define the angle. The second click defines the vertex.

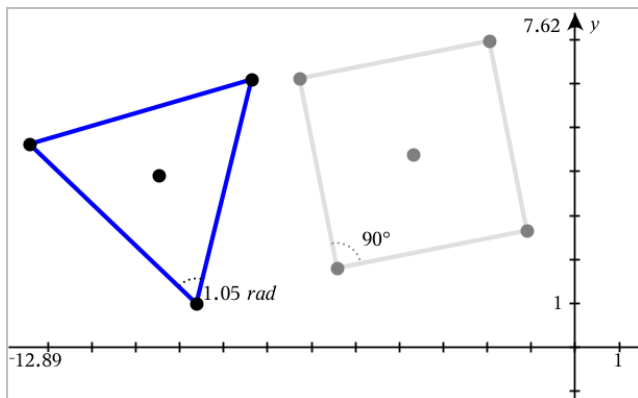

Moving a Measured Value

- Drag the measurement to the desired location.

Note: If you move a measurement too far from its object, it stops following the object. However, its value continues to be updated as you manipulate the object.

Editing a Measured Length

You can set the length of a side of a Triangle, Rectangle, or Polygon by editing its measured value.

- Double-click the measurement, and then enter the new value.

Storing a Measured Value as a Variable

Use this method to create a variable and assign a measured value to it.

1. Display the item's context menu, and select **Store**.
2. Type a variable name for the stored measurement.

Linking a Measured Length to an Existing Variable

Use this method to assign a measured length value to an existing variable.

1. Display the measurement's context menu, and select **Variables > Link to**.
The menu shows the list of currently defined variables.
2. Click the name of the variable you want to link to.

Deleting a Measurement

- Display the measurement's context menu, and select **Delete**.

Locking or Unlocking a Measurement

1. Display the measurement's context menu, and select **Attributes**.
2. Use the up/down arrow keys to highlight the Lock attribute.
3. Use the left/right arrow keys to close or open the lock.

As long as the value remains locked, manipulations are not allowed that would require the measurement to change.

Transforming Objects

You can apply transformations to drawn objects in both the Graphs and Geometry applications.

Exploring Symmetry

1. From the **Transformation** menu, select **Symmetry**. (In the Graphs application, click **Geometry > Transformation > Symmetry**.)
2. Click the object whose symmetry you want to explore.
3. Click a location or existing point to establish the point of symmetry.

A symmetrical image of the object is displayed.

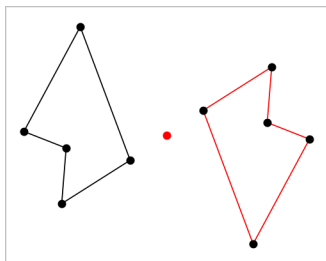

4. Manipulate the original object or the point of symmetry to explore the symmetry.

Exploring Reflection

1. Create a line or segment to predefine the line about which the object will be reflected.

- From the **Transformation** menu, select **Reflection**. (In the Graphs application, click **Geometry > Transformation > Reflection**.)
- Click the object whose reflection you want to explore.
- Click the predefined reflection line or segment.

A reflected image of the object is displayed.

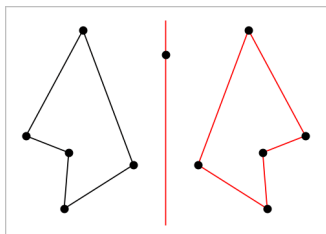

- Manipulate the original object or the line of symmetry to explore the reflection.

Exploring Translation

- (Optional) Create a vector to predefine the distance and direction of translation.
- From the **Transformation** menu, select **Translation**. (In the Graphs application, click **Geometry > Transformation > Translation**.)
- Click the object whose translation you want to explore.
- Click the predefined vector.

–or–

Click two locations on the work area to indicate the direction and distance of translation.

A translated image of the object is displayed.

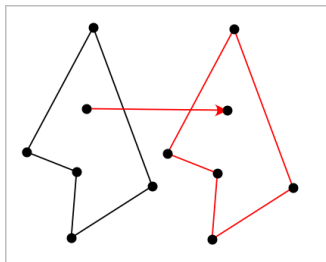

- Manipulate the original object or the vector to explore the translation.

Exploring Rotation

1. (Optional) Create an angle measurement to serve as a predefined angle of rotation.
2. From the **Transformation** menu, select **Rotation**. (In the Graphs application, click **Geometry > Transformation > Rotation**.)
3. Click the object whose rotation you want to explore.
4. Click a location or point to define the point of rotation.
5. Click the points of the predefined angle.
—or—
Click three locations to define an angle of rotation.

A rotated image of the object is displayed.

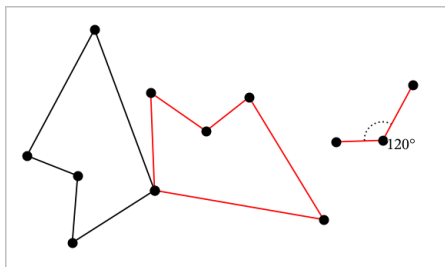

6. Manipulate the original object or the point of rotation to explore the rotation.

Exploring Dilation

1. Create a Text object containing a numeric value to serve as a predefined dilation factor.
Note: You can also use a measured length value as the dilation factor. Keep in mind that if you use a large value, you may have to pan the display to view the dilated object.
2. From the **Transformation** menu, select **Dilation**. (In the Graphs application, click **Geometry > Transformation > Dilation**.)
3. Click the object whose dilation you want to explore.
4. Click a location or existing point to define the center point of dilation.
5. Click the Text object or measurement that defines the dilation factor.
A dilated image of the object is displayed.

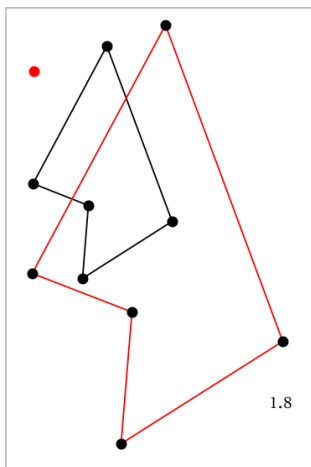

6. Manipulate the original object or the center point of dilation to explore the dilation. You can also edit the dilation factor.

Exploring with Geometric Construction Tools

While a construction is in progress, a tool appears in the work area (for example, **Parallel** ) . To cancel, press **ESC**.

Creating a Midpoint

This tool lets you bisect a segment or define a midpoint between any two points. The points can be on a single object, on separate objects, or on the work area.

1. From the **Construction** menu, select **Midpoint**. (In the Graphs application, click **Geometry > Construction > Midpoint**.)
2. Click a point or location to define the first point.
3. Click a second point or location to complete the midpoint.

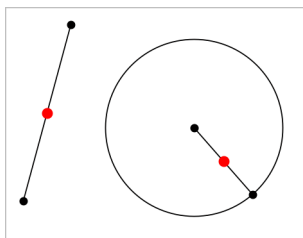

Creating a Parallel Line

This tool creates a parallel line with respect to any existing line. The existing line can be a Graphs axis or any side of a triangle, square, rectangle, or polygon.

1. From the **Construction** menu, select **Parallel**. (In the Graphs application, click **Geometry > Construction > Parallel**.)
2. Click the object that will serve as the reference line.
3. Click a location to create the parallel line.

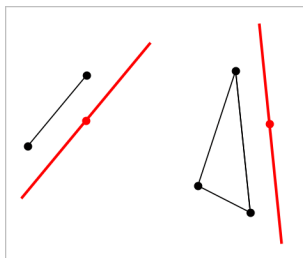

You can drag the parallel line to move it. If you manipulate the reference object, the line remains parallel.

Creating a Perpendicular Line

You can create a line that is perpendicular to a reference line. The reference can be an axis, an existing line, a segment, or one side of a triangle, rectangle, or polygon.

1. From the **Construction** menu, select **Perpendicular**. (In the Graphs application, click **Geometry > Construction > Perpendicular**.)
2. Click a location or existing point through which the perpendicular line should pass.
3. Click the item that will serve as the reference line.

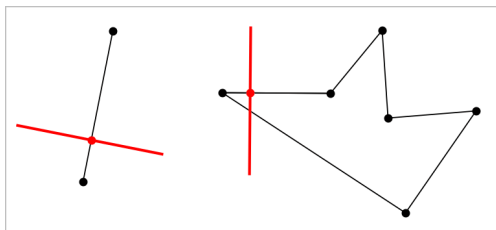

You can drag the intersection point to move the perpendicular. If you manipulate the reference object, the line remains perpendicular.

Creating a Perpendicular Bisector

You can create a perpendicular bisector on a segment, on one side of a triangle, rectangle, or polygon, or between any two points.

1. From the **Construction** menu, select **Perpendicular Bisector**. (In the Graphs application, click **Geometry > Construction > Perpendicular Bisector**.)
2. Click the item that will serve as the reference line.
–or–
Click two points to create a perpendicular bisector between them.

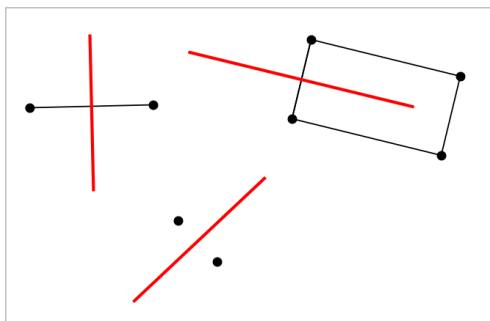

Bisecting an Angle

This tool creates an angle bisector. The points of the angle can be on existing objects, or they can be locations on the work area.

1. From the **Construction** menu, select **Angle Bisector**. (In the Graphs application, click **Geometry > Construction > Angle Bisector**.)
2. Click three locations or points to define the angle. The second click defines the vertex of the angle.

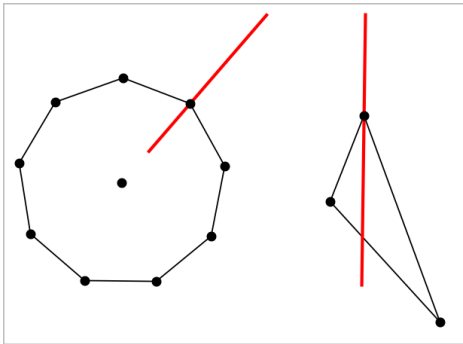

The angle bisector adjusts automatically as you manipulate its defining points.

Creating a Locus

The Locus tool enables you to explore the range of motion of one object with respect to another object as constrained by a shared point.

1. Create a segment, line, or circle.
2. Create a point on the segment, line, or circle.

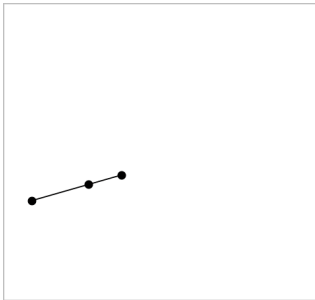

3. Create another object that uses the point created in the previous step.

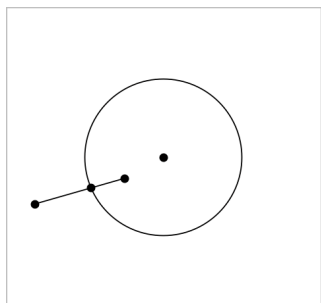

Circle created to use the defined point on the segment.

4. From the **Construction** menu, select **Locus**. (In the Graphs application, click **Geometry > Construction > Locus**.)
5. Click the point shared by the objects.
6. Click the object defined to share the point (this is the object to vary).

The continuous locus is displayed.

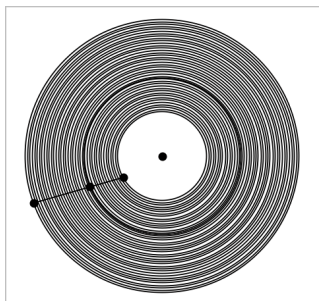

Creating a Compass

This tool operates similarly to a geometric compass used for drawing circles on paper.

1. From the **Construction** menu, select **Compass**. (In the Graphs application, click **Geometry > Construction > Compass**.)
2. To set the width (radius) of the compass:

Click a segment.

—or—

Click any side of a triangle, rectangle, polygon, or regular polygon.

–or–

Click any two existing points or locations on the work area.

3. Click a location to establish the center of the circle and complete the construction.

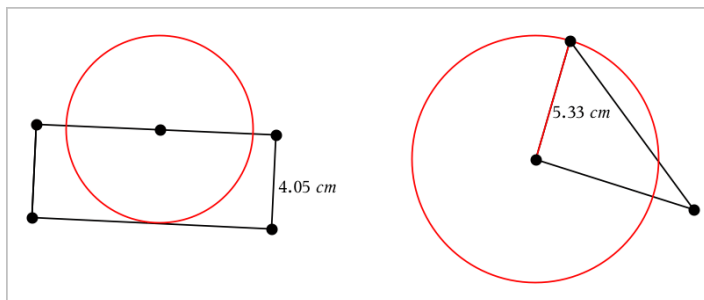



The radius adjusts automatically as you manipulate the original segment, side, or points used to define the radius.



Animating Points on Objects

You can animate any point created as a point on an object or graph. Multiple points can be animated simultaneously.

Animating a Point

1. From the **Actions** menu, select **Attributes**.
2. Click the point to display its attributes.
3. Press ▼ to select the animation attributes.
4. Press ◀ or ▶ to choose either unidirectional or alternating animation.
5. Type a value to set the animation speed. Any nonzero speed begins the animation. To reverse the direction, enter a negative value.
6. Press **Enter** to display the animation controls  .
7. Press **ESC** to close the Attributes tool.

Pausing and Resuming All Animations

- ▶ To pause all animations on a page, click **Pause** .
- ▶ To resume all animations, click **Play** .

Resetting All Animations

Resetting pauses all animations and returns all animated points to the positions they occupied when they were first animated.

- ▶ To reset animation, click **Reset** .

Changing or Stopping the Animation of a Point

1. Click **Reset**  to stop all animation.
2. From the **Actions** menu, select **Attributes**.
3. Click the point to display its attributes.
4. Select the animation attribute, and type a new animation speed. To stop the point's animation, enter zero.

Note: If other animated points exist, the animation controls remain in the work area.

Adjusting Variable Values with a Slider

In the Graphs, Geometry, and Data & Statistics applications, a slider control lets you adjust or animate the value of a numeric variable.

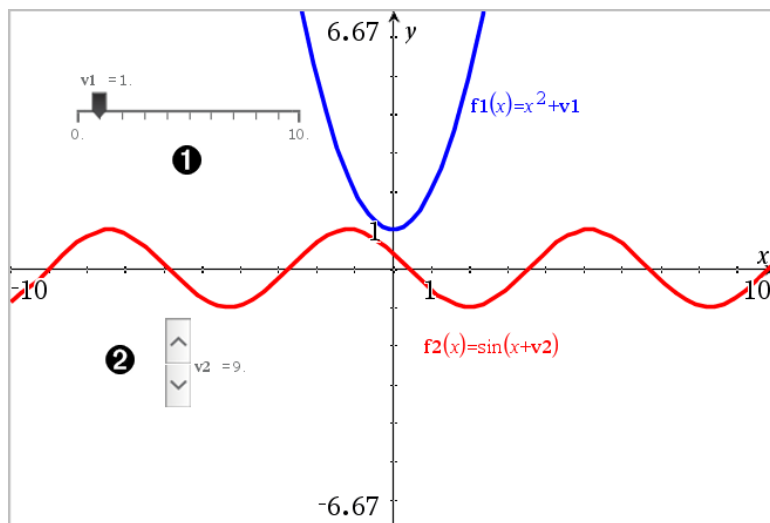

- ① Horizontal slider for adjusting variable v_1 .
- ② Minimized vertical slider for adjusting variable v_2 .

Inserting a Slider

1. Start in a Graphs, Geometry, or Data & Statistics page.
2. From the **Actions** menu, select **Insert Slider**.

The Slider Settings screen opens.

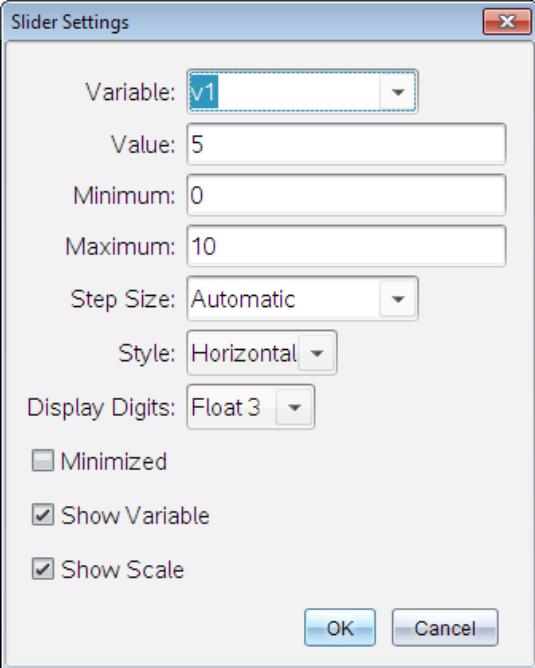

The image shows a dialog box titled "Slider Settings" with a close button (X) in the top right corner. The dialog contains the following fields and options:

- Variable:
- Value:
- Minimum:
- Maximum:
- Step Size:
- Style:
- Display Digits:
- Minimized
- Show Variable
- Show Scale
- Buttons: and

3. Enter desired values.
4. Click **OK**.

The slider is displayed in the work area. Handles on the slider let you move or stretch it. To remove the handles, click an empty space in the work area.

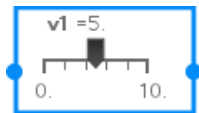

5. To adjust the variable, slide the pointer (or click the arrows on a minimized slider).

Working with the Slider

Use the options on the context menu to move or delete the slider, and to start or stop its animation. You can also change the slider's settings.

1. Display the slider's context menu.

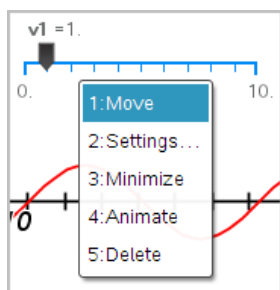

2. Click an option to select it.

Labeling (Identifying) the Coordinates of a Point

The Graphs application can identify and label the coordinates of any existing point, provided the point was created in the Graphs application.

1. From the **Actions** menu, select **Coordinates and Equations**.

The tool appears at the top of the work area

2. Tap the point whose coordinates you want to show.

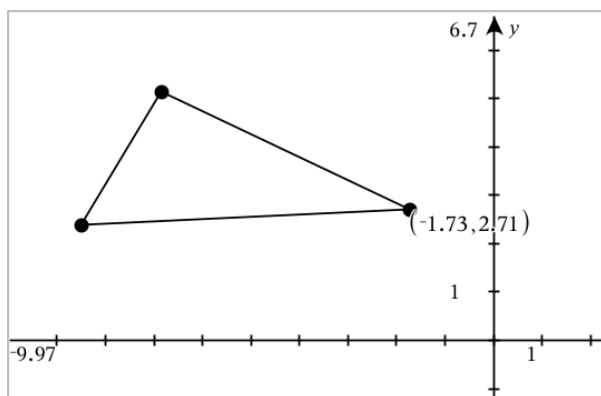

3. Press **Esc** to close the tool.

If you later move the point to a different location, the coordinates follow the point and update automatically.

Displaying the Equation of a Geometric Object

You can display the equation of a line, tangent line, circle shape, or geometric conic, provided the object was constructed in the Graphing View or within the Analytic Window of the Plane Geometry View.

Note: Due to differences in the numerical representations of analytic and geometric conics, the capability to convert a geometric conic to an analytic template may sometimes be unavailable. This is done in order to avoid a situation where the template-based conic would be different from the geometric one.

1. From the **Actions** menu, click **Coordinates and Equations**.
2. Move the pointer to the object.

The equation for the object appears.

Note: If you approach a defined point on the line or the center point of a circle, the coordinates of that point are displayed instead of the equation. Move the pointer away from the defined point to obtain the equation of the object.

3. Click to attach the equation to the pointer.
4. Move the equation to the desired location, and click to anchor it.

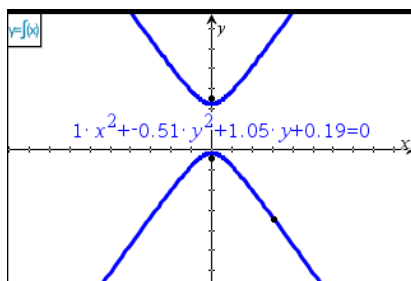

5. Press **Esc** to exit the tool.

Using the Calculate Tool

The Calculate tool is available in the Graphs and Geometry applications. It lets you evaluate a math expression you have entered as a text object. You can edit an evaluated expression, and then re-evaluate it.

In the following example, a triangle is constructed and its angles are measured using the **Angle** tool on the **Measurements** menu. The Calculate tool then adds the angles.

1. Create an object and display measurements for it.

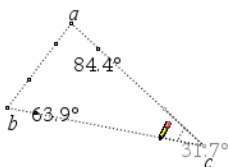

2. From the **Actions** menu, click **Text**.
3. Type the formula for the calculation. In this example, the formula adds the measurements of the three angles.

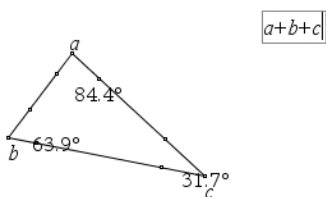

4. From the **Actions** menu, click **Calculate**.
5. Click the formula you created.

You are prompted to select a value for each term in the formula.

6. Click each angle measurement when prompted.

Note: If you have stored a measurement as a variable, you can select it when prompted by clicking . If the name of a stored measurement matches a term in the formula, you can press “L” when prompted for that term.

When all variables in the formula have values, the answer is displayed on the work area.

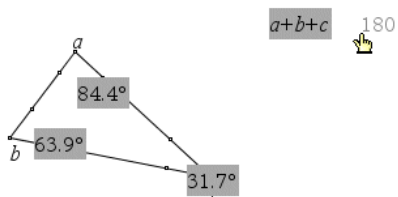



7. Press **Enter** to anchor the result as a new text object.

3D Graphs

The 3D Graphing view lets you create and explore three-dimensional graphs of:

- 3D functions of the form $z(x,y)$
- 3D parametric plots

Selecting the 3D Graphing View

The 3D Graphing View is available on any Graphs page  or Geometry page .

- From the **View** menu, select **3D Graphing**.

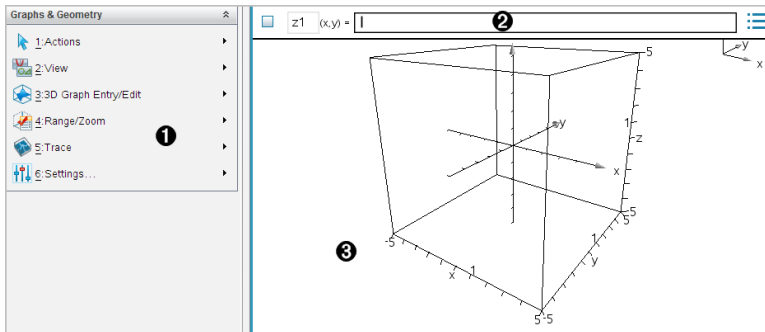

- 1 3D Graphs Menu**
- 2 Entry line.** Lets you define 3D graphs. The default graph type is 3D Function, indicated by $z1(x,y)=$.
- 3 3D Graphs Work Area.** Shows a 3D box containing graphs that you define. Drag to rotate the box.

Graphing 3D Functions

1. In the 3D Graphing view, select **3D Graph Entry/Edit > Function**.

The entry line appears.



- Enter the expression that defines the graph. You can type the expression or build it using expression templates.

$z1(x,y) =$	$\frac{12 \cdot \cos\left(\frac{x^2+y^2}{4}\right)}{3+x^2+y^2}$
-------------	---

- Press **Enter** to create the graph and hide the entry line. You can show or hide the entry line anytime by pressing **Ctrl+G**.

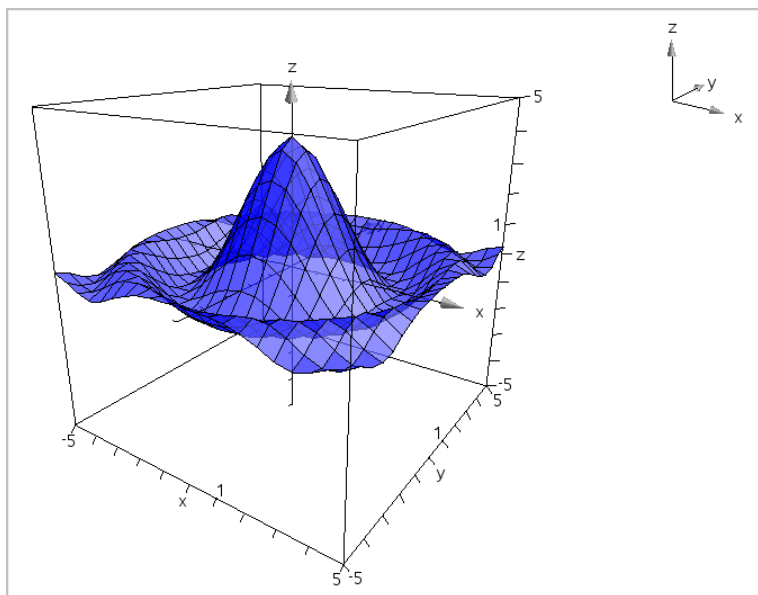

Graphing 3D Parametric Equations

- In the 3D Graphing view, select **3D Graph Entry/Edit > Parametric**.

The entry line appears.

$xp1$	$(t,u) =$	<input style="width: 100%;" type="text"/>	<input type="button" value="..."/>
$yp1$	$(t,u) =$	<input style="width: 100%;" type="text" value=" <Enter expression>"/>	
$zp1$	$(t,u) =$	<input style="width: 100%;" type="text" value=" <Enter expression>"/>	

- Type the equations that define the graph.

$xP1$	$(t,u) = 4 \cdot \cos(t) - \sin(u) \cdot \cos(t)$...
$yP1$	$(t,u) = 4 \cdot \sin(t) - \sin(u) \cdot \sin(t)$	
$zP1$	$(t,u) = \cos(u)$	

- Press **Enter** to draw the graph and hide the entry line and keyboard. You can show or hide the entry line anytime by pressing **Ctrl+G**.

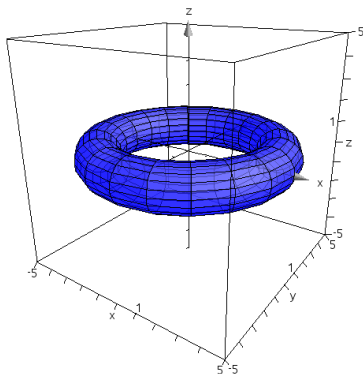

- To set the graphing parameters $tmin$, $tmax$, $umin$, and $umax$, display the graph's context menu, and select **Edit Parameters**.

3D Plot Parameters

$tmin =$

$tmax =$

$umin =$

$umax =$

Rotating the 3D View

Rotating Manually

- Press **R** to activate the Rotation tool (required only for the TI-Nspire™ handheld with Clickpad).
- Press any of the four arrow keys to rotate the graph.

Rotating Automatically

Auto rotation is equivalent to holding down the right arrow key.

1. Press **A**.

The Auto Rotation icon  appears, and the graph rotates.

2. (Optional) Use the up and down arrow keys to explore the rotating graph.
3. To stop the rotation and return to the Pointer tool, press **Esc**.

Viewing from Specific Orientations

1. If necessary, press **Esc** to return to the Pointer tool.
2. Use letter keys to select the orientation:
 - Press **Z**, **Y**, or **X** to view along the z, y, or x axis.
 - Press letter **O** to view from the default orientation.

Editing a 3D Graph

1. Double-click the graph to show its expression in the entry line.
–or–
Display the graph's context menu, and then click **Edit Relation**.



The screenshot shows a software interface with a blue cursor pointing to the text "z1 (x,y) =". To the right of the equals sign is a mathematical expression:
$$\frac{12 \cdot \cos\left(\frac{x^2 + y^2}{4}\right)}{3 + x^2 + y^2}$$

2. Modify the existing expression, or type a new expression in the entry line.
3. Press **Enter**.

Accessing the Graph History

For each problem, the software stores a history of relations defined in the Graphs application and 3D Graphing view, such as function graphs **f1** through **f99** and 3D function graphs **z1** through **z99**. You can view and edit these items using a button on the entry line.

Viewing the History

1. Press **Ctrl+G** to show the entry line.
2. Click the **History Menu** button  on the entry line.

The menu is displayed. As you point to the name of each item, its expression appears in the entry line.

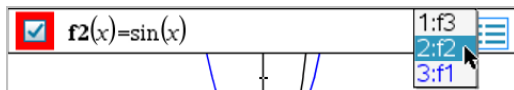

3. Select the name of the relation you want to view or edit.
4. (Optional) From the entry line, use the up and down arrow keys to scroll through the defined relations of the same type.

Viewing the History of Specific Relation Types

Use this method if you want to view or edit a defined relation that does not appear in the History menu.

1. On the **Graph Entry/Edit** menu, click the relation type. For example, click **Polar** to show the entry line for the next available Polar relation.
2. Click the **History Menu** button , or use the up and down arrow keys to scroll through the defined relations of the same type.

Changing the Appearance of a 3D Graph

Setting Wire and Surface Color:

1. Display the graph's context menu, click **Color**, and then click **Line Color** or **Fill Color**.
2. Click a color swatch to apply it.

Setting Custom Plot Colors:

You can assign different colors to a graph's top and bottom surfaces or choose to have the graph colored automatically, based on height or steepness. You can also set the wire color.

1. Display the graph's context menu, and then click **Color > Custom Plot Color**.

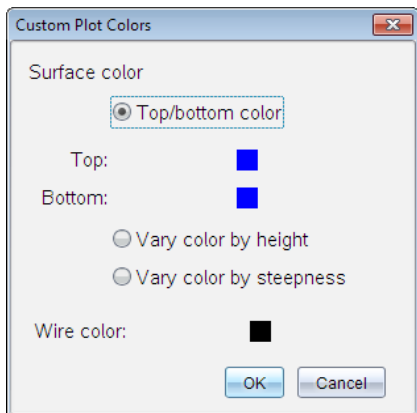

2. Select one of the three Surface color options: **Top/bottom color**, **Vary color by height**, or **Vary color by steepness**.
 - If you choose Top/bottom color, click the color swatches to select colors for the top and bottom surfaces.
 - If you choose to vary color by height or steepness, colors are determined automatically.
3. To set the Wire color, click the color swatch and select a color.

Setting Other Attributes of a Graph:

1. Display the graph's context menu, and then click **Attributes**. You can set the following attributes for the selected graph.
 - format: surface+wire, surface only, or wire only
 - x resolution (enter a value in range 2-200*, default=21)
 - y resolution (enter a value in range 2-200*, default=21)
 - transparency (enter a value in range 0-100, default=30)

* Handhelds are limited to a maximum display resolution of 21, regardless of the value entered.
2. Set the attributes as you like, and then press **Enter** to accept the changes.

Showing or Hiding a Graph's Label

- ▶ Display the graph's context menu, and then click **Hide Label** or **Show Label**.

Showing and Hiding 3D Graphs

1. In the 3D Graphing view, select **Actions > Hide/Show**.

The Hide/Show tool  appears, and all hidden items are displayed in gray.

2. Tap a graph to change its hide/show state.
3. To apply the changes and dismiss the tool, press **Esc**.

Note: If you want to show or hide only the graph's label, see [Showing or Hiding a Graph's Label](#).

Customizing the 3D Viewing Environment

Setting the Background Color

- ▶ Display the context menu for the work area, and then click **Background Color**.

Showing or Hiding Specific View Elements

- ▶ From the **View** menu, click the item to show or hide. You can choose items such as the 3D box, axes, box end values, and legend.

Setting the Visual Attributes of the Box and Axes

1. Display the context menu for the box, and then click **Attributes**. You can set the following attributes.
 - Show or hide tic labels
 - Show or hide end values
 - Show or hide arrows on axes
 - Show 3D or 2D arrow heads
2. Set the attributes as you like, and then press **Enter** to accept the changes.

Shrinking or Magnifying the 3D View

- ▶ From the **Range/Zoom** menu, click **Shrink Box** or **Magnify Box**.

To Change the 3D Aspect Ratio:

1. From the **Range/Zoom** menu, click **Aspect Ratio**.
2. Enter values for the x, y, and z axes. The default value for each axis is 1.

Changing the Range Settings

- ▶ On the **Range/Zoom** menu, click **Range Settings**. You can set the following parameters.
 - XMin (default=-5)
XMax (default=5)
XScale (default=Auto) You can enter a numeric value.
 - YMin (default=-5)
YMax (default=5)
YScale (default=Auto) You can enter a numeric value.
 - ZMin (default=-5)
ZMax (default=5)
ZScale (default=Auto) You can enter a numeric value.
 - eye θ° (default=35)
eye ϕ° (default=160)
eye distance (default=11)

Tracing in the 3D View

1. From the **Trace** menu, select **z Trace**.

The z Trace icon  and the trace plane appear, along with a text line showing the current "z=" trace value.

2. To move the trace, hold down **Shift** and press the up or down arrow key.

The "z=" text is updated as you move.

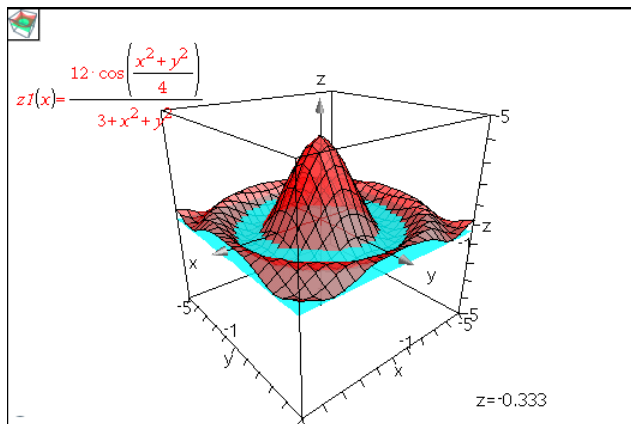

- (Optional) Use the four arrow keys to rotate the view and see how the trace plane and the graph intersect.
- To stop tracing and return to the Pointer tool, press **Esc**.

Changing the Trace Settings

- From the **Trace** menu, select **Trace Setup**.

The 3D Trace Setup dialog box opens.

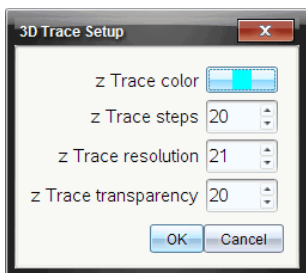

- Enter or select the settings, and click **OK** to apply them.
- If you are not already tracing, your new settings take effect the next time you trace.

Example: Creating an Animated 3D Graph

- Insert a new problem and select the 3D Graphing view.
- From the **Actions** menu, select **Insert Slider**, click to position it, and type **time** as the variable name.
- Display the slider's context menu, click **Settings**, and enter the following values.

Value: **3.8**

Minimum: **3.2**

Maximum: **4.4**

Step Size: **0.1**

- In the entry line, define the function shown here:

- Drag the slider thumb to see the effect of varying *time*.

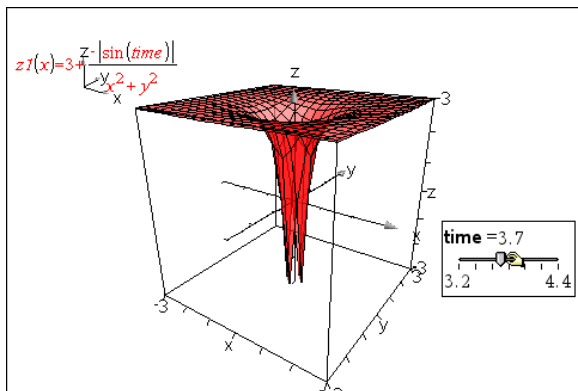

6. Add visual interest. For example:

- [Change the background color](#) of the work area.
- [Hide the box, axes, or legend.](#)
- [Automatically rotate](#) the graph.
- [Change the graph's fill color and hide its lines.](#)
- Change the graph's [transparency and shading.](#)

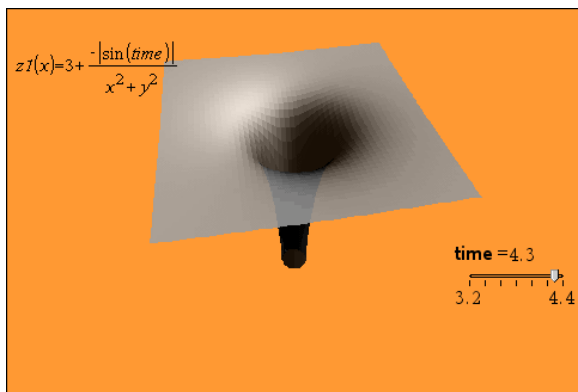

7. To animate the graph, display the slider's context menu, and click **Animate**. (To stop, click **Stop Animate** from the context menu.)

You can combine manual or auto rotation with the slider animation.

Experiment with the x and y resolution to balance curve definition against animation smoothness.

Geometry Application

The Geometry application lets you:

- Create and explore geometric objects and constructions.
- Manipulate and measure geometric objects.
- Animate points on objects and explore their behavior.
- Explore object transformations.

Adding a Geometry Page

- ▶ To start a new document with a blank Geometry page:

From the main **File** menu, click **New Document**, and then click **Add Geometry**.

Handheld: Press **[fn] on**, and select **Geometry** .

- ▶ To add a Geometry page in the current problem of an existing document:

From the toolbar, click **Insert > Geometry**.

Handheld: Press **[doc]** and select **Insert > Geometry**.

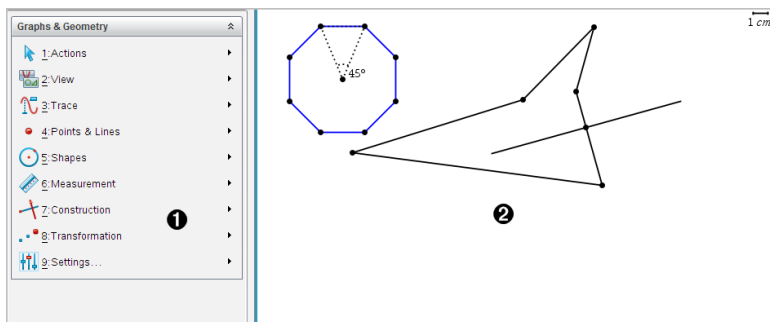

- 1 Geometry menu - Available anytime you are viewing a Geometry page.
- 2 Geometry work area -- The area where you create and explore geometric objects.

What You Must Know

Changing the Graphs and Geometry Settings

1. From the **Settings** menu, select **Settings**.
2. Select the settings that you want to use.
 - **Display Digits.** Sets the display format for numbers as Floating or Fixed decimal.
 - **Graphing Angle.** Sets angle unit for the Graphs application only. To use the current Document Settings, set this to **Auto**.
 - **Geometry Angle.** Sets angle unit for the Geometry application only. To use the current Document Settings, set this to **Auto**.
 - **Automatically hide plot labels.** In the Graphs application, hides the label that normally appears next to a graphed relation.
 - **Show axis end values.** Applies only in the Graphs application.
 - **Show tool tips for function manipulation.** Applies only in the Graphs application.
 - **Automatically find points of interest.** In the Graphs application, shows zeros, minima, and maxima while tracing function graphs.
 - Click **Restore** to restore all settings to their factory defaults.
 - Click **Make Default** to apply the current settings to the open document and save them as the default for new Graphs and Geometry documents.

Using Context Menus

Context menus provide quick access to commonly used commands and tools that apply to a specific object. For example, you can use a context menu to change an object's line color or to group a set of selected objects.

- ▶ Display the context menu for an object in one of the following ways.
 - Windows®: Right-click the object.
 - Mac®: Hold \mathcal{K} and click the object.
 - Handheld: Move the pointer to the object, and then press ctrl menu.

Finding Hidden Objects in the Graphs or Geometry Application

You can hide and show individual graphs, geometric objects, text, labels, measurements, and axis end-values.

To temporarily view hidden graphs or objects or to restore them as shown objects:

1. From the **Actions** menu, select **Hide/Show**.

The Hide/Show tool  appears in the work area, and all hidden objects become visible in dimmed colors.

2. Click a graph or object to toggle its Hide/Show state.
3. To apply the changes and close the Hide/Show tool, press **ESC**.

Inserting a Background Image

You can insert an image as a background for a Graphs or Geometry page. The file format of the image can be .bmp, .jpg, or .png.

1. From the **Insert** menu, click **Image**.
2. Navigate to the image you want to insert, select it, and then click **Open**.

For information on moving, resizing, and deleting a background image, see [Working with Images in the Software](#).

Adding Text to the Graphs or Geometry Work Area

1. From the **Actions** menu, select **Text**.

The Text tool  appears in the work area.

2. Click the location for the text.
3. Type the text in the box that appears, and then press **Enter**.

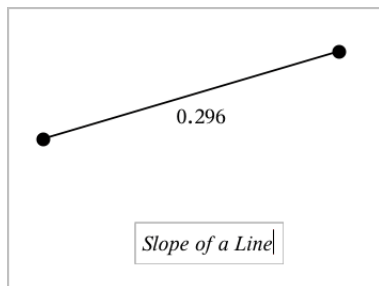

4. To close the Text tool, press **ESC**.

5. To edit the text, double-click it.

Deleting a Relation and its Graph

1. Select the relation by clicking its graph.
2. Press **Backspace** or **DEL**.

The graph is removed from both the work area and the graph history.

Introduction to Geometric Objects

Geometry tools are accessible in both the Graphs and Geometry applications. You can use these tools to draw and investigate objects such as points, lines, and shapes.

- The Graphing view shows the Graphs work area superimposed on the Geometry work area. You can select, measure, and alter objects in both work areas.
- The Plane Geometry view shows only the objects created in the Geometry application.

Objects Created in the Graphs Application

Points, lines, and shapes created in the Graphs application are analytic objects.

- All points that define these objects reside on the x,y graph plane. Objects created here are visible only in the Graphs application. Changing the axes scale affects the appearance of the objects.
- You can display and edit the coordinates of any point on an object.
- You can display the equation of a line, tangent line, circle shape, or geometric conic created in the Graphs application.

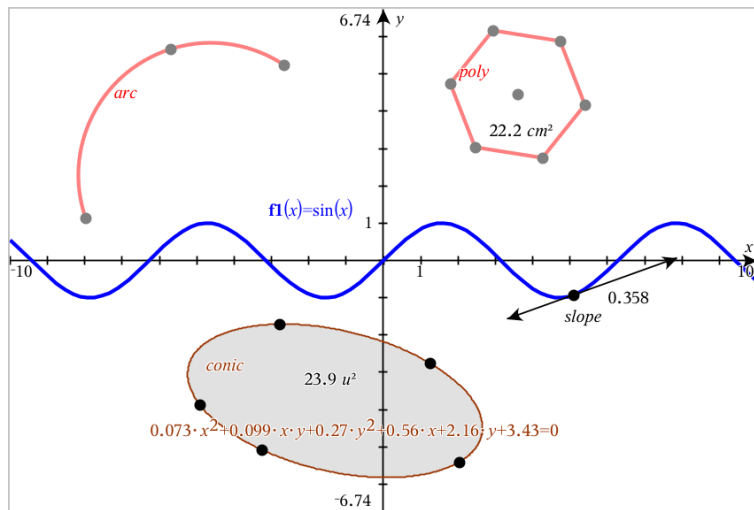

The circle arc and polygon were created in the Geometry application. The sine wave and conic were created in the Graphs application.

Objects Created in the Geometry Application

Points, lines, and shapes created in the Geometry application are not analytic objects.

- Points that define these objects do not reside on the graph plane. Objects created here are visible in both the Graphs and Geometry applications, but they are unaffected by changes to the Graphs x,y axes.
- You cannot obtain the coordinates of an object's points.
- You cannot display the equation of a geometric object created in the Geometry application

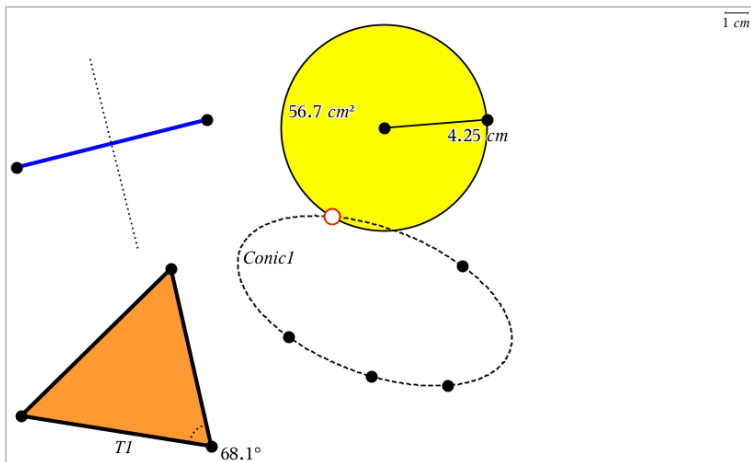

Creating Points and Lines

As you create an object, a tool appears in the work area (for example, **Segment** ). To cancel, press **ESC**.

Creating a Point on the Work Area

1. From the **Points and Lines** menu, select **Point**. (In the Graphs application, click **Geometry > Points and Lines > Point**.)
2. Click a location to create the point.
3. (Optional) Label the point.
4. To move a point, drag it.

Creating a Point on a Graph or Object

You can create a point on a line, segment, ray, axis, vector, circle, graph, or axis.

1. From the **Points and Lines** menu, select **Point On**. (In the Graphs application, click **Geometry > Points and Lines > Point On**.)
2. Click the graph or object on which you want to create the point.
3. Click a location on the object to place the point.

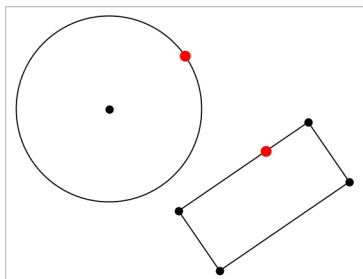

Identifying Points of Intersection

1. From the **Points and Lines** menu, select **Intersection Points**. (In the Graphs application, click **Geometry > Points and Lines > Intersection Points**.)
2. Click two intersecting objects to add points at their intersections.

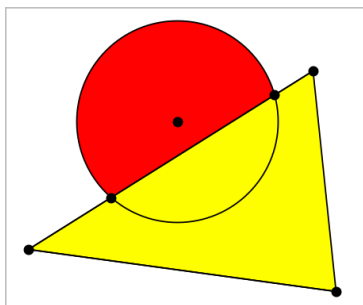

Creating a Line

1. From the **Points and Lines** menu, select **Line**. (In the Graphs application, click **Geometry > Points and Lines > Line**.)
2. Click a location to define one point on the line.
3. Click a second location to define the direction of the line and the length of its visible portion.

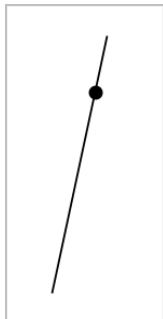

4. To move a line, drag its identifying point. To rotate it, drag any point except the identifying point or ends. To extend its visible portion, drag from either end.

Creating a Segment

1. From the **Points and Lines** menu, select **Segment**. (In the Graphs application, click **Geometry > Points and Lines > Segment**.)
2. Click two locations to define the endpoints of the segment.

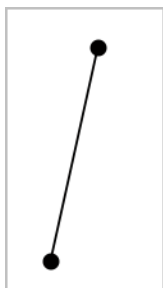

3. To move a segment, drag any point other than an endpoint. To manipulate the direction or length, drag either endpoint.

Creating a Ray

1. From the **Points and Lines** menu, select **Ray**. (In the Graphs application, click **Geometry > Points and Lines > Ray**.)
2. Click a location to define the endpoint of the ray.
3. Click a second location to define the direction.

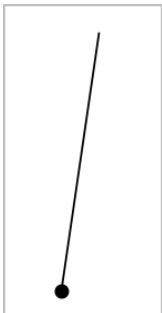

To move a ray, drag its identifying point. To rotate it, drag any point except the identifying point or end. To extend its visible portion, drag from the end.

Creating a Tangent

You can create a tangent line at a specific point on a geometric object or function graph.

1. From the **Points and Lines** menu, select **Tangent**. (In the Graphs application, click **Geometry > Points and Lines > Tangent**.)
2. Click the object to select it.
3. Click a location on the object to create the tangent.

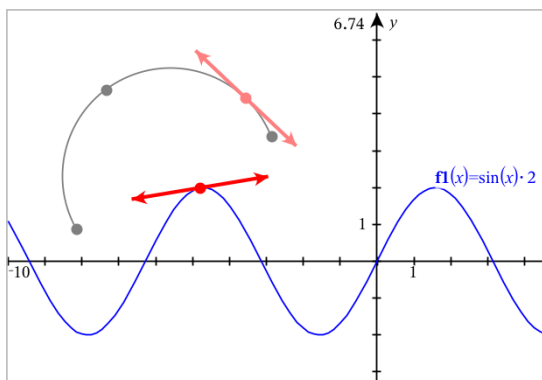

4. To move a tangent, drag it. It remains attached to the object or graph.

Creating a Vector

1. From the **Points and Lines** menu, select **Vector**. (In the Graphs application, click **Geometry > Points and Lines > Vector**.)

- Click a location to establish the vector's initial point.
- Click a second location to specify direction and magnitude and complete the vector.

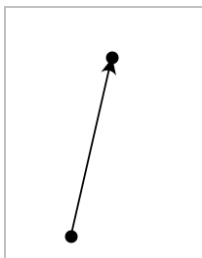

- To move a vector, drag any point other than the endpoints. To manipulate the magnitude and/or direction, drag either end point.

Note: If you create an endpoint on an axis or another object, you can move the endpoint only along that object.

Creating a Circle Arc

- From the **Points and Lines** menu, select **Circle Arc**. (In the Graphs application, click **Geometry > Points and Lines > Circle Arc**.)
- Click a location or point to establish the starting point of the arc.
- Click a second point to establish an intermediate point through which the arc will pass.
- Click a third point to set the ending point and complete the arc.

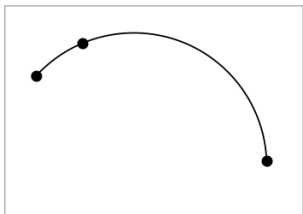

- To move an arc, drag its perimeter. To manipulate it, drag any of its three defining points.

Creating Geometric Shapes

The Shape tools let you explore circles, polygons, conics, and other geometric objects.

As you create a shape, a tool appears in the work area (for example, **Circle** ). To cancel the shape, press **ESC**.

Creating a Circle

1. From the **Shapes** menu, select **Circle**. (In the Graphs application, click **Geometry > Shapes > Circle**.)
2. Click a location or point to position the circle's center point.
3. Click a location or point to establish the radius and complete the circle.

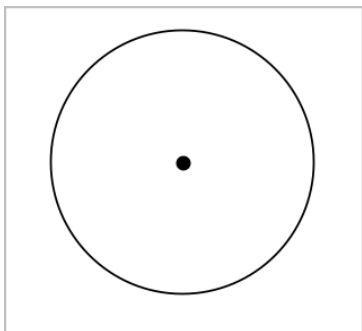

4. To resize a circle, drag its perimeter. To move it, drag its center point.

Creating a Triangle

1. From the **Shapes** menu, select **Triangle**. (In the Graphs application, click **Geometry > Shapes > Triangle**.)
2. Click three locations to establish the vertices of the triangle.

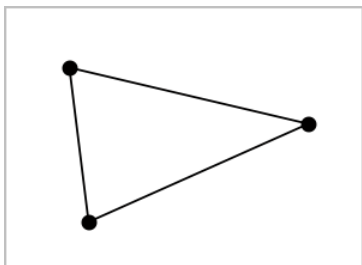

- To manipulate a triangle, drag any point. To move it, drag any side.

Creating a Rectangle

- From the **Shapes** menu, select **Rectangle**. (In the Graphs application, click **Geometry > Shapes > Rectangle**.)
- Click a location or point to establish the first corner of the rectangle.
- Click a location for the second corner.
One side of the rectangle is displayed.
- Click to establish the distance to the opposite side and complete the rectangle.

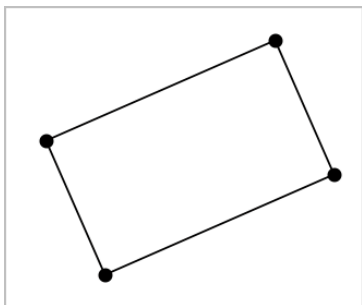

- To rotate a rectangle, drag one of its first two points. To extend it, drag one of the last two points. To move it, drag any side.

Creating a Polygon

- From the **Shapes** menu, select **Polygon**. (In the Graphs application, click **Geometry > Shapes > Polygon**.)
- Click a location or point to establish the first vertex of the polygon.
- Click to establish each additional vertex.
- To complete the polygon, click the first vertex.

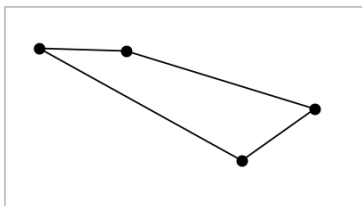

- To manipulate a polygon, drag any vertex. To move it, drag any side.

Creating a Regular Polygon

- From the **Shapes** menu, select **Regular Polygon**. (In the Graphs application, click **Geometry > Shapes > Regular Polygon**.)
- Click once on the work area to establish the center point.
- Click a second location to establish the first vertex and radius.

A 16-sided regular polygon is formed. The number of sides is displayed in brackets; for example, {16}.

- Drag any vertex in a circular motion to set the number of sides.
 - Drag clockwise to reduce the number of sides.
 - Drag counterclockwise to add diagonals.

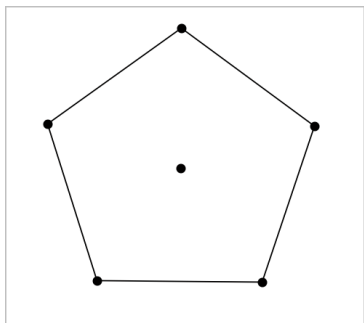

- To resize or rotate a regular polygon, drag any of its points. To move it, drag any side.

Creating an Ellipse

- From the **Shapes** menu, select **Ellipse**. (In the Graphs application, click **Geometry > Shapes > Ellipse**.)
- Click two locations or points to establish the foci.
- Click to establish a point on the ellipse and complete the shape.

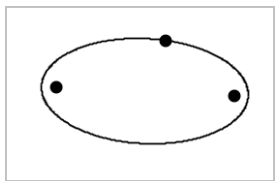

4. To manipulate an ellipse, drag any of its three defining points. To move it, drag its perimeter.

Creating a Parabola (from focus and vertex)

1. From the **Shapes** menu, select **Parabola**. (In the Graphs application, click **Geometry > Shapes > Parabola**.)
2. Click a location to establish the focus.
3. Click a location to establish the vertex and complete the parabola.

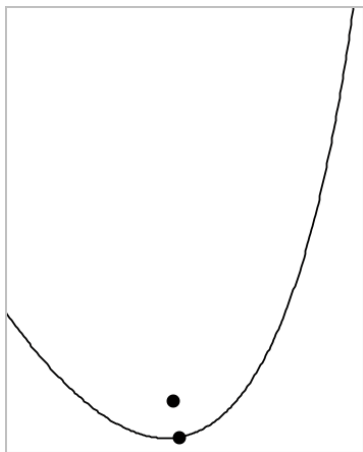

4. To manipulate a parabola, drag its focus or its vertex. To move it, drag it from any other point.

Creating a Parabola (from focus and directrix)

1. Create a line to serve as the directrix.
2. From the **Shapes** menu, select **Parabola**. (In the Graphs application, click **Geometry > Shapes > Parabola**.)
3. Click a location to establish the focus.
4. Click the line to establish it as the directrix.

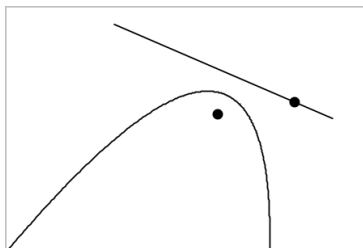

5. To manipulate a parabola, rotate or move its directrix or drag its focus. To move it, select both the directrix and the focus, and then drag either object.

Creating a Hyperbola

1. From the **Shapes** menu, select **Hyperbola**. (In the Graphs application, click **Geometry > Shapes > Hyperbola**.)
2. Click two locations to establish the foci.
3. Click a third location to complete the hyperbola.

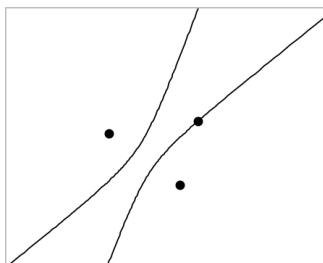

4. To manipulate a hyperbola, drag any of its three defining points. To move it, drag it from any other place on the shape.

Creating a Conic by Five Points

1. From the **Shapes** menu, select **Conic by Five Points**. (In the Graphs application, click **Geometry > Shapes > Conic by Five Points**.)
2. Click five locations to establish the five points on the shape.
Depending on the pattern of the points, the conic can be a hyperbola or an ellipse.

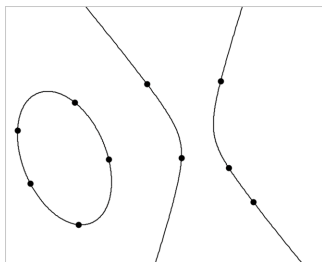

3. To manipulate a conic, drag any of its five defining points. To move it, drag it from any other place on the shape.

Basics of Working with Objects

Selecting and Deselecting Objects

You can select an individual object or multiple objects. Select multiple objects when you want to quickly move, color, or delete them together.

1. Click an object or graph to select it.
The object flashes to indicate selection.
2. Click any additional objects to add them to the selection.
3. Perform the operation (such as moving or setting color).
4. To deselect all objects, click an empty space in the work area.

Grouping and Ungrouping Geometric Objects

Grouping objects gives you a way to reselect them as a set, even after you have deselected them to work with other objects.

1. Click each object to add it to the current selection.
The selected objects flash.
2. Display a context menu of the selected object or objects.
3. Click **Group**. You can now select all the items in the group by clicking any of its members.
4. To split a group into individual objects, display a context menu of any of its member objects, and click **Ungroup**.

Deleting Objects

1. Display the context menu of the object or objects.
2. Click **Delete**.

You cannot delete the origin, the axes, or points representing locked variables, even if those items are included in the selection.

Moving Objects

You can move an object, group, or combination of selected objects and groups.

Note: If an immovable object (such as the graph axes or a point with locked coordinates) is included in a selection or group, you cannot move any of the objects. You must cancel the selection and then select only movable items.

To move this...	Drag this
A multiple-object selection or group	Any of its objects
A point	The point
A segment or vector	Any point other than an endpoint
A line or ray	The identifying point
A circle	The center point
Other geometric shapes	Any position on the object except one of its defining points. For example, move a polygon by dragging any of its sides.

Constraining Object Movement

Holding down the **SHIFT** key before dragging lets you constrain how certain objects are drawn, moved, or manipulated.

Use the constraint feature to:

- Rescale only a single axis in the Graphs application.

- Pan the work area horizontally or vertically, depending on which direction you drag initially.
- Limit object movement to horizontal or vertical.
- Limit point placement to 15° increments as you draw a triangle, rectangle, or polygon.
- Limit angle manipulations to 15° increments.
- Limit the radius of a resized circle to integer values.

Pinning Objects

Pinning objects prevents accidental changes as you move or manipulate other objects.

You can pin graphed functions, geometric objects, text objects, the graph axes, and the background.

1. Select the object or objects to pin, or click an empty area if you are pinning the background.
2. Display the context menu, and select **Pin**.

A pinned object displays a pin icon  when you point to it.

3. To unpin an object, display its context menu, and select **Unpin**.

Notes:

- Although you cannot drag a pinned point, you can reposition it by editing its x and y coordinates.
- You cannot pan the work area while the background is pinned.

Changing the Line or Fill Color of an Object

Color changes made in the software are displayed in shades of gray when you work on documents using a TI-Nspire™ handheld that does not support color. Color is preserved when you move documents back to the software.

1. Select the object or objects.
2. Display the object's context menu, click **Color**, and then click **Line Color** or **Fill Color**.
3. Select the color to apply to the objects.

Changing the Appearance of an Object

1. From the **Actions** menu, select **Attributes**.
2. Click the object that you want to change. You can change shapes, lines, graphs, or graph axes.

The list of the attributes for the selected object are displayed.

3. Press ▲ and ▼ to move through the list of attributes.
4. At each attribute icon, press ◀ or ▶ to move through the options. For example, select Thick, Thin, or Medium for the Line Weight attribute.
5. Press **Enter** to apply the changes.
6. Press **ESC** to close the Attributes tool.

Labeling Points, Geometric Lines, and Shapes

1. Display the context menu of the object.
2. Click **Label**.
3. Type the text of the label, and then press **Enter**.

The label attaches itself to the object and follows the object as you move it. The label's color matches the object's color.

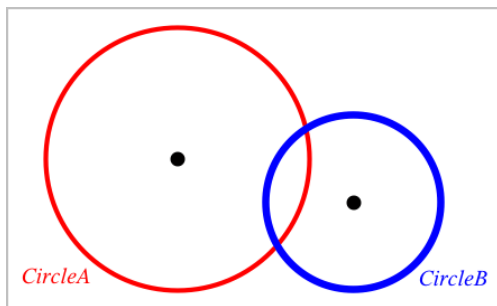

Measuring Objects

Measurement values update automatically as you manipulate the measured object.

Note: Measurements of objects created in the Graphs application are displayed in generic units named *u*. Measurements of objects created in the Geometry application are displayed in centimeters (*cm*).

Measuring Length of a Segment, Circle Arc, or Vector

1. From the **Measurement** menu, select **Length**. (In the Graphs application, click **Geometry > Measurement > Length**.)
2. Click the object to display its length.

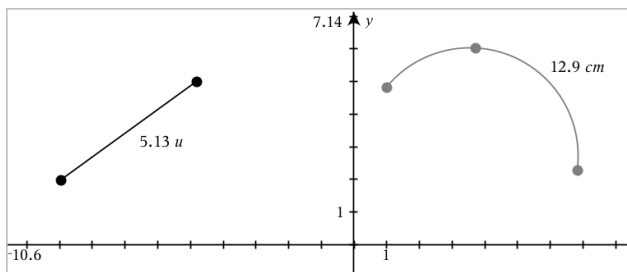

Measuring Distance Between Two Points, a Point and a Line, or a Point and a Circle

1. From the **Measurement** menu, select **Length**. (In the Graphs application, click **Geometry > Measurement > Length**.)
2. Click the first point.
3. Click the second point or a point on the line or circle.

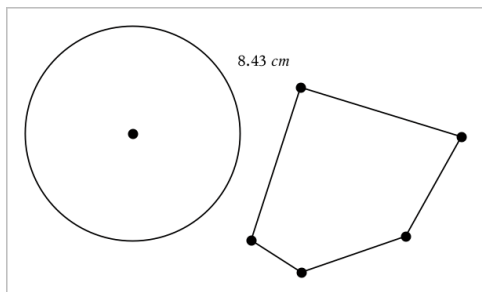

In this example, length is measured from the center of the circle to the upper left vertex of the polygon.

Measuring Circumference of a Circle or Ellipse or the Perimeter of a Polygon, Rectangle, or Triangle

1. From the **Measurement** menu, select **Length**. (In the Graphs application, click **Geometry > Measurement > Length**.)

- Click the object to display its circumference or perimeter.

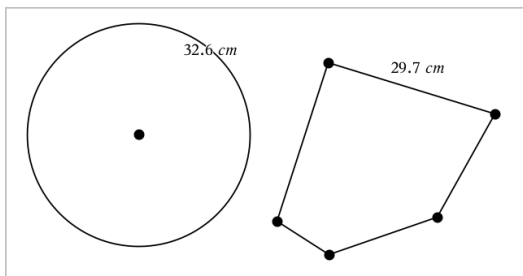

Measuring a Side of a Triangle, Rectangle, or Polygon

- From the **Measurement** menu, select **Length**. (In the Graphs application, click **Geometry > Measurement > Length**.)
- Click two points on the object that form the side you want to measure.

Note: You must click *two points* to measure a side. Clicking the side measures the entire length of the object's perimeter.

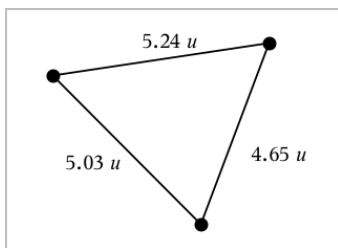

Measuring Area of a Circle, Ellipse, Polygon, Rectangle, or Triangle

Note: You cannot measure the area of a polygon constructed using the Segment tool.

- From the **Measurement** menu, select **Area**. (In the Graphs application, click **Geometry > Measurement > Area**.)
- Click the object to display its area.

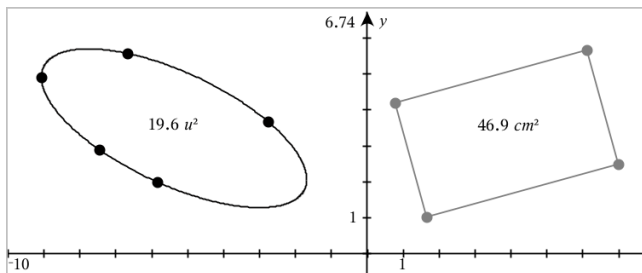

Measuring Slope of a Line, Ray, Segment, or Vector

1. From the **Measurement** menu, select **Slope**. (In the Graphs application, click **Geometry > Measurement > Slope**.)
2. Click the object to display its slope.

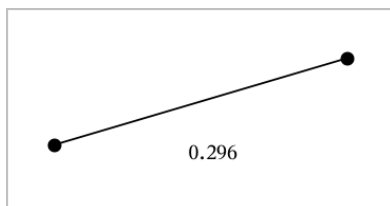

The value is updated automatically when you manipulate the object.

Measuring Angles

Measured angles in the Geometry application range from 0° to 180° . Measured angles in the Graphs application range from 0 radians to π radians. To change the angle unit, use the **Settings** menu.

1. From the **Measurement** menu, select **Angle**. (In the Graphs application, click **Geometry > Measurement > Angle**.)
2. Click three locations or points to define the angle. The second click defines the vertex.

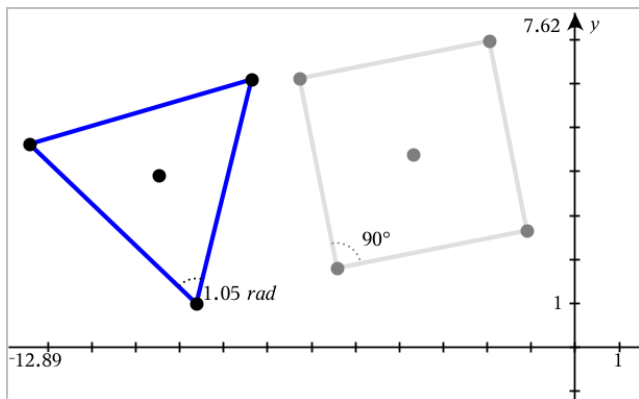

Moving a Measured Value

- Drag the measurement to the desired location.

Note: If you move a measurement too far from its object, it stops following the object. However, its value continues to be updated as you manipulate the object.

Editing a Measured Length

You can set the length of a side of a Triangle, Rectangle, or Polygon by editing its measured value.

- Double-click the measurement, and then enter the new value.

Storing a Measured Value as a Variable

Use this method to create a variable and assign a measured value to it.

1. Display the item's context menu, and select **Store**.
2. Type a variable name for the stored measurement.

Linking a Measured Length to an Existing Variable

Use this method to assign a measured length value to an existing variable.

1. Display the measurement's context menu, and select **Variables > Link to**.
The menu shows the list of currently defined variables.
2. Click the name of the variable you want to link to.

Deleting a Measurement

- Display the measurement's context menu, and select **Delete**.

Locking or Unlocking a Measurement

1. Display the measurement's context menu, and select **Attributes**.
2. Use the up/down arrow keys to highlight the Lock attribute.
3. Use the left/right arrow keys to close or open the lock.

As long as the value remains locked, manipulations are not allowed that would require the measurement to change.

Transforming Objects

You can apply transformations to drawn objects in both the Graphs and Geometry applications.

Exploring Symmetry

1. From the **Transformation** menu, select **Symmetry**. (In the Graphs application, click **Geometry > Transformation > Symmetry**.)
2. Click the object whose symmetry you want to explore.
3. Click a location or existing point to establish the point of symmetry.

A symmetrical image of the object is displayed.

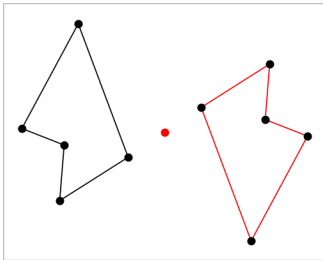

4. Manipulate the original object or the point of symmetry to explore the symmetry.

Exploring Reflection

1. Create a line or segment to predefine the line about which the object will be reflected.

- From the **Transformation** menu, select **Reflection**. (In the Graphs application, click **Geometry > Transformation > Reflection**.)
- Click the object whose reflection you want to explore.
- Click the predefined reflection line or segment.

A reflected image of the object is displayed.

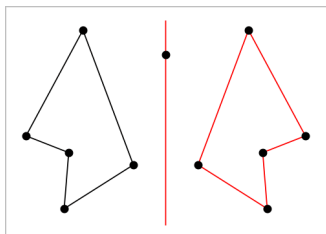

- Manipulate the original object or the line of symmetry to explore the reflection.

Exploring Translation

- (Optional) Create a vector to predefine the distance and direction of translation.
- From the **Transformation** menu, select **Translation**. (In the Graphs application, click **Geometry > Transformation > Translation**.)
- Click the object whose translation you want to explore.
- Click the predefined vector.

–or–

Click two locations on the work area to indicate the direction and distance of translation.

A translated image of the object is displayed.

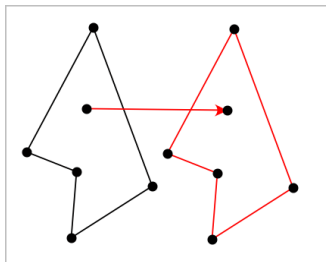

- Manipulate the original object or the vector to explore the translation.

Exploring Rotation

1. (Optional) Create an angle measurement to serve as a predefined angle of rotation.
2. From the **Transformation** menu, select **Rotation**. (In the Graphs application, click **Geometry > Transformation > Rotation**.)
3. Click the object whose rotation you want to explore.
4. Click a location or point to define the point of rotation.
5. Click the points of the predefined angle.
—or—
Click three locations to define an angle of rotation.

A rotated image of the object is displayed.

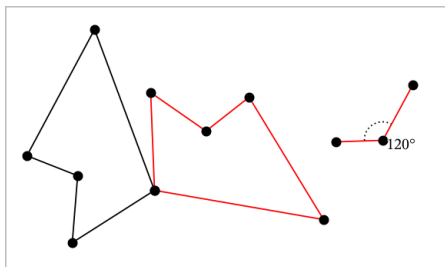

6. Manipulate the original object or the point of rotation to explore the rotation.

Exploring Dilation

1. Create a Text object containing a numeric value to serve as a predefined dilation factor.
Note: You can also use a measured length value as the dilation factor. Keep in mind that if you use a large value, you may have to pan the display to view the dilated object.
2. From the **Transformation** menu, select **Dilation**. (In the Graphs application, click **Geometry > Transformation > Dilation**.)
3. Click the object whose dilation you want to explore.
4. Click a location or existing point to define the center point of dilation.
5. Click the Text object or measurement that defines the dilation factor.
A dilated image of the object is displayed.

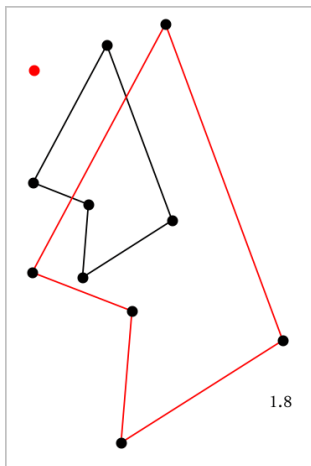

6. Manipulate the original object or the center point of dilation to explore the dilation. You can also edit the dilation factor.

Exploring with Geometric Construction Tools

While a construction is in progress, a tool appears in the work area (for example, **Parallel** ) . To cancel, press **ESC**.

Creating a Midpoint

This tool lets you bisect a segment or define a midpoint between any two points. The points can be on a single object, on separate objects, or on the work area.

1. From the **Construction** menu, select **Midpoint**. (In the Graphs application, click **Geometry > Construction > Midpoint**.)
2. Click a point or location to define the first point.
3. Click a second point or location to complete the midpoint.

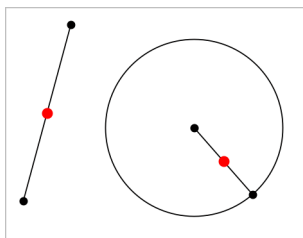

Creating a Parallel Line

This tool creates a parallel line with respect to any existing line. The existing line can be a Graphs axis or any side of a triangle, square, rectangle, or polygon.

1. From the **Construction** menu, select **Parallel**. (In the Graphs application, click **Geometry > Construction > Parallel**.)
2. Click the object that will serve as the reference line.
3. Click a location to create the parallel line.

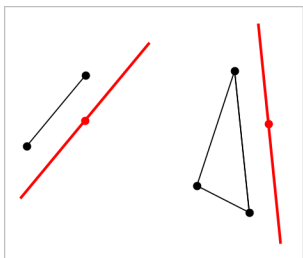

You can drag the parallel line to move it. If you manipulate the reference object, the line remains parallel.

Creating a Perpendicular Line

You can create a line that is perpendicular to a reference line. The reference can be an axis, an existing line, a segment, or one side of a triangle, rectangle, or polygon.

1. From the **Construction** menu, select **Perpendicular**. (In the Graphs application, click **Geometry > Construction > Perpendicular**.)
2. Click a location or existing point through which the perpendicular line should pass.
3. Click the item that will serve as the reference line.

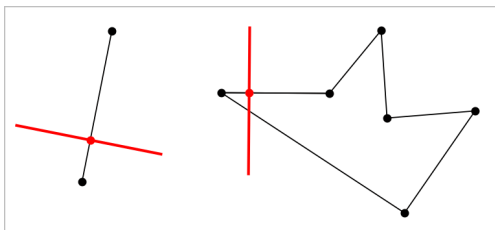

You can drag the intersection point to move the perpendicular. If you manipulate the reference object, the line remains perpendicular.

Creating a Perpendicular Bisector

You can create a perpendicular bisector on a segment, on one side of a triangle, rectangle, or polygon, or between any two points.

1. From the **Construction** menu, select **Perpendicular Bisector**. (In the Graphs application, click **Geometry > Construction > Perpendicular Bisector**.)
2. Click the item that will serve as the reference line.
–or–
Click two points to create a perpendicular bisector between them.

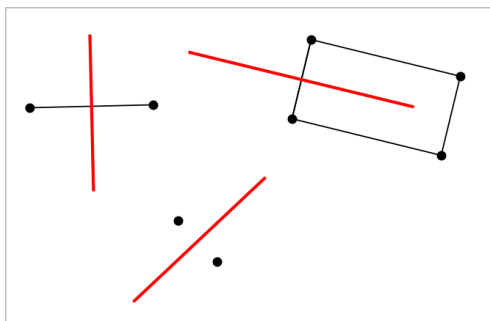

Bisecting an Angle

This tool creates an angle bisector. The points of the angle can be on existing objects, or they can be locations on the work area.

1. From the **Construction** menu, select **Angle Bisector**. (In the Graphs application, click **Geometry > Construction > Angle Bisector**.)
2. Click three locations or points to define the angle. The second click defines the vertex of the angle.

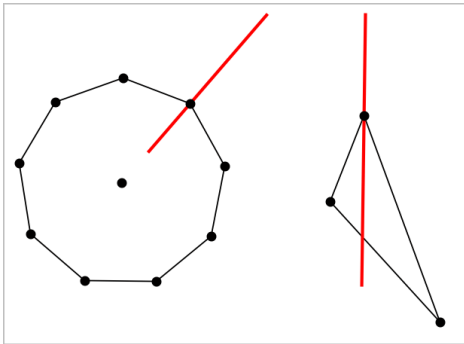

The angle bisector adjusts automatically as you manipulate its defining points.

Creating a Locus

The Locus tool enables you to explore the range of motion of one object with respect to another object as constrained by a shared point.

1. Create a segment, line, or circle.
2. Create a point on the segment, line, or circle.

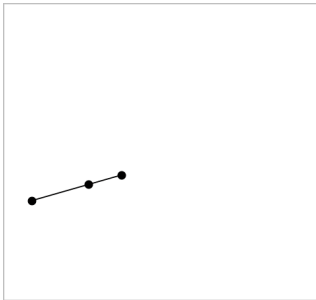

3. Create another object that uses the point created in the previous step.

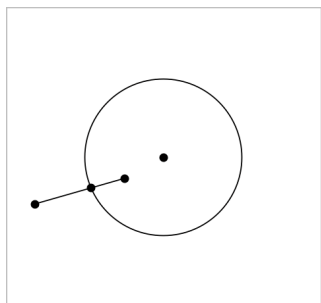

Circle created to use the defined point on the segment.

4. From the **Construction** menu, select **Locus**. (In the Graphs application, click **Geometry > Construction > Locus**.)
5. Click the point shared by the objects.
6. Click the object defined to share the point (this is the object to vary).

The continuous locus is displayed.

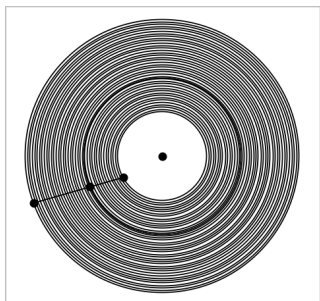

Creating a Compass

This tool operates similarly to a geometric compass used for drawing circles on paper.

1. From the **Construction** menu, select **Compass**. (In the Graphs application, click **Geometry > Construction > Compass**.)
2. To set the width (radius) of the compass:

Click a segment.

—or—

Click any side of a triangle, rectangle, polygon, or regular polygon.

–or–

Click any two existing points or locations on the work area.

3. Click a location to establish the center of the circle and complete the construction.

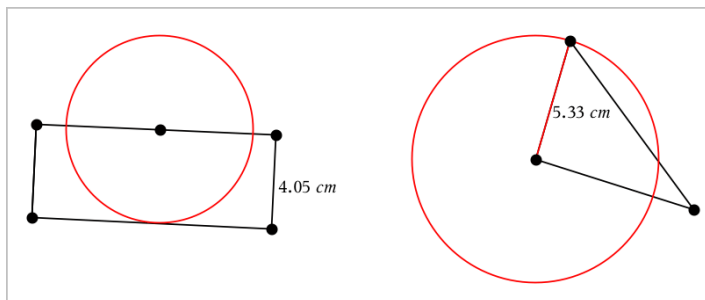

The radius adjusts automatically as you manipulate the original segment, side, or points used to define the radius.

Using Geometry Trace

The Geometry Trace tool leaves a visible trail of a geometric object or function graph as it is moved or manipulated. The movement can be done manually or by [using animation](#). This tool is accessible in both the Graphs and Geometry applications.

1. From the **Trace** menu, select **Geometry Trace**.

The Geometry Trace tool appears.

2. Click the object or function that you want to trace to select it.
3. Drag the object, or play the animation.

This example shows traces of a graphed function manipulated by dragging and a triangle manipulated by animation.

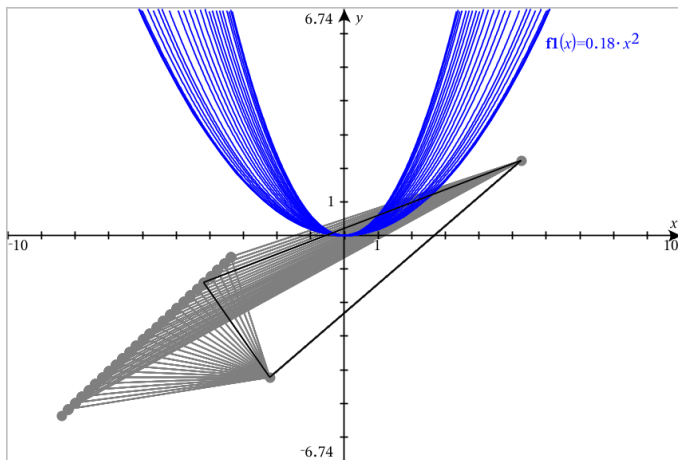

Note: You cannot select or manipulate the trace trail.

4. To erase all trails, select **Erase Geometry Trace** from the **Trace** menu.
5. To stop tracing, press **Esc**.

Conditional Attributes

You can cause objects to hide, show, and change color dynamically, based on specified conditions such as " $r_1 < r_2$ " or " $\sin(a_1) \geq \cos(a_2)$."

For example, you might want to hide an object based on a changing measurement that you have assigned to a variable, or you might want an object's color to change based on a "Calculate" result assigned to a variable.

Conditional behaviors can be assigned to objects or groups in the Graphing, Plane Geometry, and 3D Graphing views.

Setting Conditional Attributes of an Object

You can set conditions of a selected object either by using its context menu or by activating the Set Conditions tool from the **Actions** menu and then selecting the object. These instructions describe using the context menu.

1. Select the object or group.
2. Display the object's context menu, and click **Conditions**.

The conditional attributes are displayed.

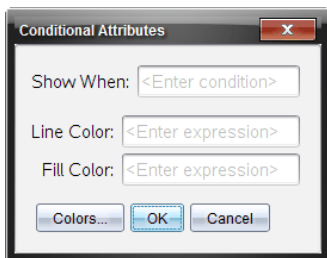

For 2D objects

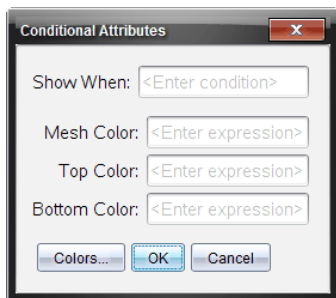

For 3D objects

- (Optional) In the **Show When** field, enter an expression specifying the conditions during which the object will be shown. Anytime the condition is not satisfied, the object will be hidden.

You can specify tolerance by using compound conditionals in the **Show When** input field. For example, $\text{area} \geq 4$ and $\text{area} \leq 6$.

Note: If you need to see conditionally hidden objects temporarily, click **Actions > Hide/Show**. To return to normal viewing, press **ESC**.

- (Optional) Enter numbers or expressions that evaluate to numbers in the applicable color fields, such as **Line Color** or **Mesh Color**. To see a map of color values, click the **Colors** button.

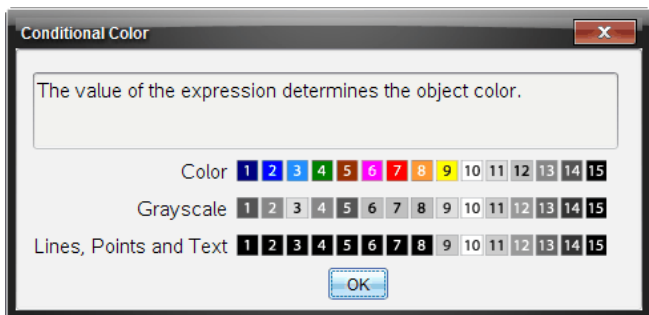

Map of conditional color values

- Click **OK** in the Conditional Attributes dialog box to apply the conditions.

Hiding Objects in the Geometry Application

The Hide/Show tool reveals objects you have previously selected as hidden and lets you select which objects to show or hide.

1. From the **Actions** menu, select **Hide/Show**.

The Hide/Show tool appears, and currently hidden items (if any) are shown dimmed.

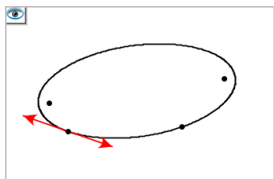

2. Click objects to toggle their hide/show status.

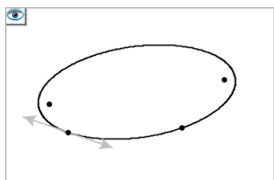

3. Press **Esc** to complete your selections and close the tool.

All objects you selected as hidden objects disappear.

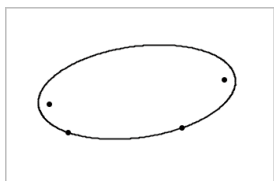

4. To view the hidden objects temporarily or restore them as shown objects, open the Hide/Show tool.

Customizing the Geometry Work Area

Inserting a Background Image

You can [insert an image](#) as a background for any Graphs or Geometry page.

1. From the **Insert** menu, click **Image**.
2. Navigate to the image you want to insert, select it, and then click **Open**.

Adding a Text Object to the Work Area

Use the Text tool to add numeric values, formulas, observations, or other explanatory information to the Geometry work area.

1. From the **Actions** menu, select **Text**.
2. Click the location for the text.
3. Type the text in the box that appears, and then press **Enter**.

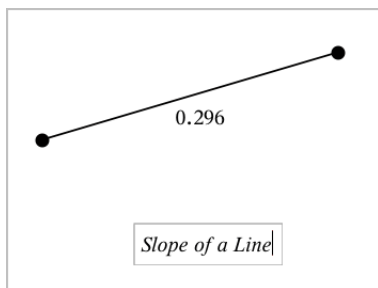

To move a text object, drag it. To edit the text, double-click it. To delete a text object, display its context menu, and select **Delete**.

Changing the Attributes of Numeric Text



If you enter a numeric value as text, you can lock it or set its format and displayed precision.

1. From the **Actions** menu, select **Attributes**.
2. Click the numeric text to display its list of attributes.
3. Press **▲** and **▼** to move through the list.
4. At each attribute icon, press **◀** or **▶** to move through the options. For example, select **0** through **9** as the precision.
5. Press **Enter** to apply the changes.
6. Press **Esc** to close the Attributes tool.



Animating Points on Objects

You can animate any point created as a point on an object or graph. Multiple points can be animated simultaneously.

Animating a Point

1. From the **Actions** menu, select **Attributes**.
2. Click the point to display its attributes.
3. Press ▼ to select the animation attributes.
4. Press ◀ or ▶ to choose either unidirectional or alternating animation.
5. Type a value to set the animation speed. Any nonzero speed begins the animation. To reverse the direction, enter a negative value.
6. Press **Enter** to display the animation controls  .
7. Press **ESC** to close the Attributes tool.

Pausing and Resuming All Animations

- ▶ To pause all animations on a page, click **Pause** .
- ▶ To resume all animations, click **Play** .

Resetting All Animations

Resetting pauses all animations and returns all animated points to the positions they occupied when they were first animated.

- ▶ To reset animation, click **Reset** .

Changing or Stopping the Animation of a Point

1. Click **Reset**  to stop all animation.
2. From the **Actions** menu, select **Attributes**.
3. Click the point to display its attributes.
4. Select the animation attribute, and type a new animation speed. To stop the point's animation, enter zero.

Note: If other animated points exist, the animation controls remain in the work area.

Adjusting Variable Values with a Slider

In the Graphs, Geometry, and Data & Statistics applications, a slider control lets you adjust or animate the value of a numeric variable.

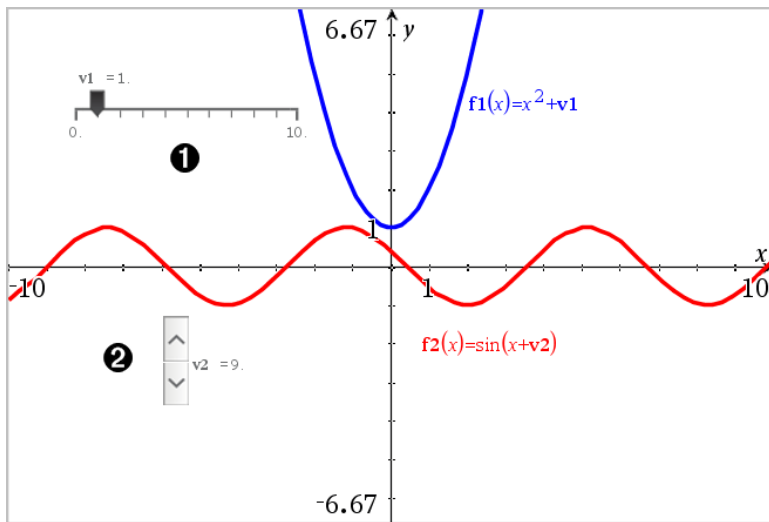

- ❶ Horizontal slider for adjusting variable v_1 .
- ❷ Minimized vertical slider for adjusting variable v_2 .

Inserting a Slider

1. Start in a Graphs, Geometry, or Data & Statistics page.
2. From the **Actions** menu, select **Insert Slider**.
The Slider Settings screen opens.

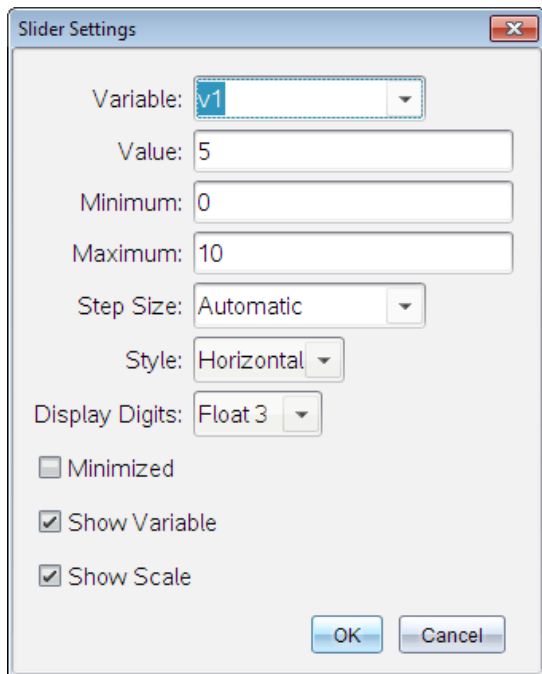

3. Enter desired values.
4. Click **OK**.

The slider is displayed in the work area. Handles on the slider let you move or stretch it. To remove the handles, click an empty space in the work area.

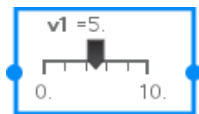

5. To adjust the variable, slide the pointer (or click the arrows on a minimized slider).

Working with the Slider

Use the options on the context menu to move or delete the slider, and to start or stop its animation. You can also change the slider's settings.

1. Display the slider's context menu.

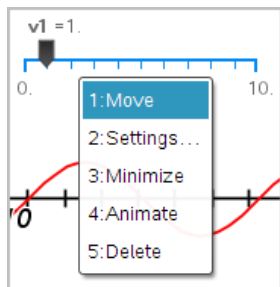

2. Click an option to select it.

Using the Calculate Tool

The Calculate tool is available in the Graphs and Geometry applications. It lets you evaluate a math expression you have entered as a text object. You can edit an evaluated expression, and then re-evaluate it.

In the following example, a triangle is constructed and its angles are measured using the **Angle** tool on the **Measurements** menu. The Calculate tool then adds the angles.

1. Create an object and display measurements for it.

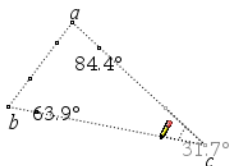

2. From the **Actions** menu, click **Text**.
3. Type the formula for the calculation. In this example, the formula adds the measurements of the three angles.

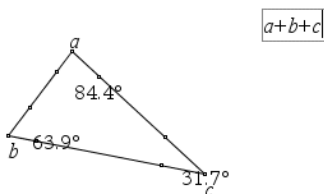

4. From the **Actions** menu, click **Calculate**.

5. Click the formula you created.

You are prompted to select a value for each term in the formula.

6. Click each angle measurement when prompted.

Note: If you have stored a measurement as a variable, you can select it when prompted by clicking . If the name of a stored measurement matches a term in the formula, you can press "L" when prompted for that term.

When all variables in the formula have values, the answer is displayed on the work area.

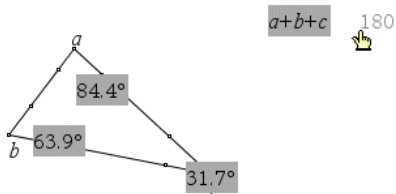

7. Press **Enter** to anchor the result as a new text object.

Lists & Spreadsheet Application

The Lists & Spreadsheet application gives you a place to work with tabular data. It lets you:

- Store numeric data, text, or math expressions.
- Define a table cell in terms of the contents of other cells.
- Define an entire column based on the contents of another column.
- Share columns of data as list variables with other TI-Nspire™ applications. Also share individual cells as variables.
- Work with variables created in the Graphs & Geometry and Calculator applications.
- Collect tables of real-world data from sensors.
- Generate columns of data-based sequences that you define.
- Plot table data using the Data & Statistics application.
- Generate a table of values for a function.
- Copy and paste table data from the Lists & Spreadsheet application to other computer applications, such as TI Connect™ software and Excel® spreadsheet software.
- Perform statistical analysis on lists of data.

Adding a Lists & Spreadsheet Page

- ▶ To start a new document with a blank Lists & Spreadsheet page:

From the main **File** menu, click **New Document**, and then click **Lists & Spreadsheet**.

Handheld: Press , and select **Lists & Spreadsheet** .

- ▶ To add a Lists & Spreadsheet page in the current problem of an existing document:

From the toolbar, click **Insert > Lists & Spreadsheet**.

Handheld: Press , and select **Insert > Lists & Spreadsheet**.

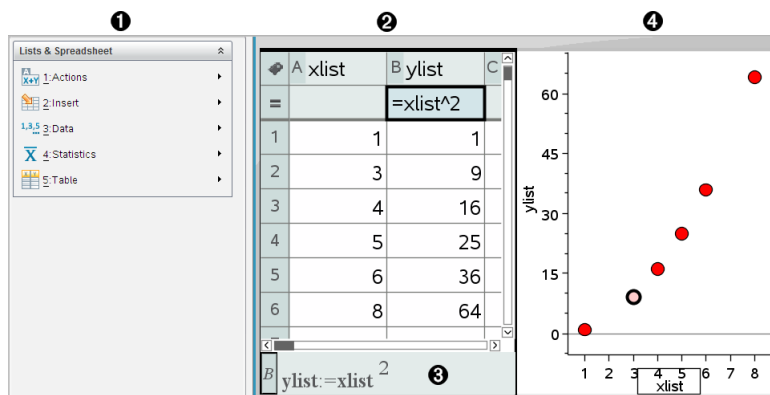

- ❶ Lists & Spreadsheet tools (available when a Lists & Spreadsheet work area is active)
- ❷ Sample Lists & Spreadsheet work area
- ❸ Lists & Spreadsheet entry line
- ❹ Lists & Spreadsheet data plotted in the Data & Statistics application

Creating and Sharing Spreadsheet Data as Lists

You can define a column as a named list of elements of the same type of data. After defining a list, you can link to it from the Graphs & Geometry, Calculator, or Data & Statistics applications, and from other instances of the Lists & Spreadsheet application within the current problem.

Note: Lists & Spreadsheet can display a maximum of 2500 elements in a list.

Sharing a Spreadsheet Column as a List Variable

You share a column of data by naming it as a list variable.

Note: Avoid defining variables that use the same names as those used for statistical analysis. In some cases, an error condition could occur.

Variable names used for statistical analysis are listed in the *TI-Nspire™ Reference Guide*, under the **stat.results** entry.

1. Click the cell to move to the column's name cell (the top cell of the column).

–or–

Press ▲ as necessary.

2. Type a name for the list variable, and press **Enter**.

The column is now available as a list variable to other TI-Nspire™ applications.

3. Create elements in the list the same as you would create data in spreadsheet cells. For example, you can type the data into each cell or use a formula to generate a column of data.

Notes:

- If a variable with the name you specified already exists in the current problem, Lists & Spreadsheet displays an error message.
- When you select the column formula cell of a list, it displays the list name in an expression similar to `width:=`.
- Lists can contain empty elements (denoted by “_”).
- You can refer to a specific element in a named list from the Calculator application. Use the list name and the element’s position within the list. In a list named Heights, for example, refer to the first element as Heights[1]. The expression Heights[2] refers to the second element, and so on.



Linking to an Existing List Variable

Linking a column to an existing list variable lets you easily view and edit the values in the list. The list can be any shared list in the current problem and can be defined in Graphs & Geometry, Calculator, or any instance of Lists & Spreadsheet.

After you link a column to a list, Lists & Spreadsheet automatically shows any changes that you make to the list with other TI-Nspire™ applications.

1. Click the column formula cell (the second cell from the top) of the column that you want to link to the variable.
2. Type the name of the list variable you want to link to.

–or–

Click  on the toolbar (press  on the handheld), click **Link To**, and click the variable you want to link to.

3. Press **Enter**.

The column shows the list elements.

Notes:

- You cannot link to the same variable multiple times on the same page.
- Use caution if you link to a system variable. Doing so could prevent the variable from being updated by the system. System variables include *ans* and statistics results (such as *stat.results*, *stat.RegEqn*, and *stat.Resid*).

Inserting an Element in a List

When you insert an element in a list, the remaining elements shift downward to create space. No other columns are affected.

- ▶ Click **Insert > Insert Cell**.

Deleting an Element from a List

When you delete an element, the remaining list elements shift upward to close the gap. The upward shift affects only the selected column.

1. Click the cell of the element to delete.
2. Open the context menu for the cell, and click **Delete Cell**.

Note: If you press **Del** or **Backspace** to clear the contents of the cell instead of deleting the list element, the element is assigned a value of 0 (zero). The remaining list elements do not shift.

Creating Spreadsheet Data

You can type numeric values, text, or formulas into body cells. Column formula cells can contain formulas only. (For more information, see *Generating Columns of Data*.)

Data Examples

Entry	Remarks
1.234	Simple numeric entry
"Green"	Text - Enclose categorical data (such as the names of colors used in a study) within quotes to distinguish them from variable names. Handheld: Press <input type="text" value="ctrl"/> <input type="text" value="x"/> to enter quoted data.
=a3*length	Formula - Consists of an "=" symbol followed by an

Entry	Remarks
	<p>expression.</p> <p>You can type the expression or use the Catalog and expression templates to build it. For more information, see the <i>Calculator</i> section.</p> <p>To ensure a decimal result instead of a fraction, type one of the integers in the expression as a decimal. For example, type 1.0 instead of 1.</p>

Typing a Math Expression, Text, or Spreadsheet Formula

1. Double-click the cell to select it and put it in edit mode.

Note: If the cell is already selected, you can press **Enter** or click the entry line.

2. Type the expression, text, or formula. Be sure to enclose text entries in quotes and start formula entries with an “=” symbol.

As you type the data, it appears in the cell and on the entry line simultaneously.

3. Press **Enter** to complete the entry and move down to the next cell.

–or–

Press **Tab** to complete the entry and move right to the next cell.

The Lists & Spreadsheet application automatically recalculates any cells that are dependent on the cell you entered. If you have shared the cell, and other TI-Nspire™ applications are linked to the cell, the other applications are also updated.

Note: Empty cells in a spreadsheet display as a void represented by an underscore (_). The underscore is automatically added to empty cells when a list is named or when an empty cell is referenced in a formula. When you plan to perform calculations on a range of cells, be sure to notice the location of void cells. Cells without a value can affect calculations. For example, if you include a void cell in the range for a sum such as “=b2+c2,” the result of the calculation is void (_).

Inserting a Cell Range into a Formula

The Select Range feature lets you insert a cell range (such as a1:b3) into a formula by selecting the range instead of typing cell addresses into an argument.

Suppose you want to calculate the mean of a range of cells.

1. Select the cell that will contain the result.
2. From the **Data** menu, click **List Math > Mean**.

An editable formula appears in the cell.

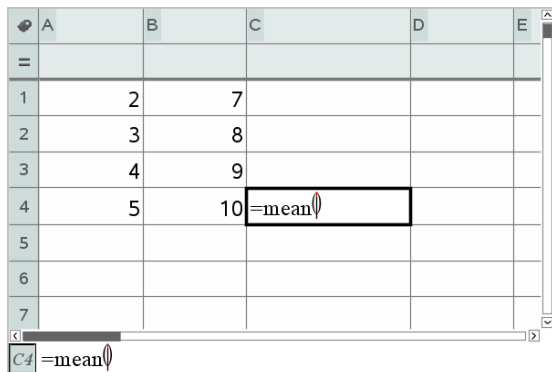

	A	B	C	D	E
=					
1		2	7		
2		3	8		
3		4	9		
4		5	10		
5					
6					
7					

3. Click **Actions > Select > Select Formula Range**.
4. Drag a selection rectangle around the range of values for which you want to calculate the mean.

Handheld: Move to the first cell in the range, hold **[⇧]**, and press the arrow keys.

The formula is updated as you select the cells.

	A	B	C	D	E
=					
1		2	7		
2		3	8		
3		4	9		
4		5	10	=mean(a1:b4)	
5					
6					
7					

C4 =mean(a1:b4)

5. Press **Enter** to complete the formula and display the result.

Navigating in a Spreadsheet

A spreadsheet includes a column letter at the top of each column and a row number on the left of each row. The top two rows and the row numbers remain in place as you scroll. You can name a column of data to make it available as a list variable in TI-Nspire™ applications.

	A	B	C	D	E
=					
1	6				
2	27				
3	—				
4	15				
5	236		143489...		
6					

C5 =a2⁵

- ① Column reference letter
- ② Column name cell for defining a column as a list variable
- ③ Column formula cell for generating a column of data

- ④ Row reference number
- ⑤ Body Cells - Any empty (void) element in a list is displayed as an underscore (“_”). Any value that cannot fit in a cell’s width is truncated (143489...). Hover over the cell to display the complete value.
- ⑥ Entry line (includes cell reference for current cell)

You can select any cell to view or edit its contents. When a spreadsheet is larger than the Lists & Spreadsheet work area, you can move to different parts of the spreadsheet by using the **Tab** key and by pressing shortcut keys.

- ▶ Press **Tab** to move between the body of the spreadsheet (data zone) and the column names and formulas (naming zone).
- ▶ Press **◀**, **▶**, **▲**, and **▼** to move through the spreadsheet one cell at a time (move between cells within a zone). The arrow keys move the cursor from cell to cell and scroll as necessary to keep the selected cell in view.
- ▶ Move across several cells at a time by pressing **Page up**, **Page Dn**, **Home**, and **End**.

Handheld: Press **ctrl** **9** (**Page up**), **ctrl** **3** (**Page Dn**), **ctrl** **7** (**Home**), and **ctrl** **1** (**End**) keys.

- ▶ Use the **Go To** command on the **Actions** menu to select a specific cell. Type the cell’s column letter and row number (such as **G16**).
- ▶ Press **Enter** to put the selected cell in Edit mode.
- ▶ Drag the scroll bar to move vertically without changing the cell or block of cells selected.

Working with Cells

Working with Color

The Lists & Spreadsheet application displays black text and cells with a white background by default. You can change the color of cells and text to emphasize or distinguish data. The colors and the order in which color is assigned is based on the TI-Nspire™ color palette.

Color changes made in the software are displayed in shades of gray when you work on documents on the TI-Nspire™ handheld. Color is preserved when you move documents back to the software.

Changing the Fill Color of Cells

1. Select the cells to fill with color. You can choose one or more cells in any adjacent cells, columns, or rows.
2. Access the context menu and click **Color > Fill Color**.
3. Click the color to apply to the cells.

Note: If you combine color text and color cells, choose colors carefully to ensure visibility as you work with documents in the software and on the handheld.

Changing the Color of Text

1. Select the cells that contain the text to change. You can choose one or more cells in any adjacent cells, columns, or rows.
2. Access the context menu and click **Color > Text Color**.
3. Click the color to apply to the text. Empty cells in the selection area show the color change when text is added.

Understanding Cell References in Formulas

Use a cell reference to use data from a cell or range of cells in a formula. The calculation results update automatically when values in cells change.

Relative references include only the cell's column letter and row number (for example, E7). A relative reference describes where a cell is in relation to other cells of the spreadsheet. The Lists & Spreadsheet application keeps track of relative cell references and adjusts the reference automatically when surrounding cells shift (because of actions you perform, such as column deletions or cell insertions).

Follow these guidelines to specify cell references:

- Include a column letter and row number in a relative reference.
- Include the \$ symbol before both the column letter and the row number to specify an absolute reference.
- Include a colon (:) between a two cell reference to specify a range of cells.

Absolute references include the \$ symbol before the column letter and before the row number (for example, \$B\$16). Absolute references always refer to the cell in a specific position in the spreadsheet. The application does not automatically adjust the cell reference when cell positions change.

Typing a Cell Reference in a Formula

1. Double-click the cell and type the formula. For more information, see the *Calculator* section.
2. Move to the appropriate position in the formula and type the cell reference. Use the format for a relative reference (B3), absolute reference (\$B\$2), or range of cells (A1:A4).

Note: You can click **Recalculate** on the **Actions** menu to update all references and formula results in a spreadsheet.

Deleting the Contents of Cells

1. Click a cell to select it.

–or–

Use the arrow keys to move to the cell.

Note: If you are deleting a range of cells, select a cell at one end or corner of the range, and then use **Shift** with the arrow keys to select the remaining cells in the range.

2. Press **Del**.

Note: Any cell that uses a formula with an absolute reference to deleted data shows an error. A cell that uses a formula with a relative reference to deleted data is updated to use the data currently in the referenced position.

Copying Cells

When you copy cells, any formulas in the original cells are copied to the destination cells.

1. Click the cell to copy.

–or–

Use the arrow keys to move to the cell.

Note: If you are copying a range of cells, select a cell at one end or corner of the range, and then use **Shift** with the arrow keys to select the remaining cells in the range.

2. Use the standard key shortcut for copying a selection.

Windows®: Press **Ctrl+C**.

Mac®: Press **⌘+C**.

Handheld: Press **ctrl** **C**.

3. Click the cell where you want to duplicate the copied cell. If you are copying a block of data, click the cell that will become the upper left corner of the copied block.

4. Paste the selected cells:

Windows®: Press **Ctrl+V**.

Mac®: Press **⌘+V**.

Handheld: Press **ctrl** **V**.

Important: Paste copied data into a cell that is in the same mode as the cell from which the data was originally copied. Otherwise, a formula could paste as a string enclosed in quotes instead of a formula.

Filling Adjacent Cells

You can repeat a cell's formula or value throughout adjacent cells within the row or column. You can also repeat a range of cells horizontally or vertically. If you fill from a range that contains a simple sequence (such as 2, 4, 6), the sequence continues in the filled cells.

1. Click the cell that contains the value or formula to repeat.

Note: If you are repeating a range of cells, drag to select the range, or select a cell at one end of the range, and then use **Shift** with the arrow keys to select the remaining cells.

2. Click **Data > Fill**.
3. Use the arrow keys, or drag to select the range that will hold the repetitions.
4. Press **Enter**.



The value, formula, or pattern that you selected for duplication is repeated over the selected range.

Sharing a Cell Value as a Variable

You can share the value of a cell with other TI-Nspire™ applications by storing it as a variable. When you define or refer to a shared cell or variable in Lists & Spreadsheet, the name is preceded with an apostrophe (').

1. Click the cell that you want to share.

- Click  on the toolbar, and click **Store Var** to store the cell's value.

Handheld: Press   or press  and select **Store Var**).





A formula is inserted into the cell with *var* as a placeholder for a variable name.

- Type over the letters “*var*” with a name for the variable, and press **Enter**. Use a variable name that does not exist in the current problem.

The value is shown in bold to indicate that it is now available as a variable to other TI-Nspire™ applications.

Linking a Cell to a Variable

When you link a cell to a variable, Lists & Spreadsheet keeps the cell value updated to reflect the current value of the variable. The variable can be any variable in the current problem and can be defined in Graphs & Geometry, Calculator, Data & Statistics, or any instance of Lists & Spreadsheet.

- Click the cell that you want to link to a variable.
- Click  on the toolbar, and click **Link to**.
Handheld: Press   or press  and select **Link to**.
The VarLink menu opens.
- Under **Link To**, press **▲**, and **▼** to scroll to the name of the variable.
- Press **Enter**.

The cell shows the value of the variable.

Note: Use caution if you link to a system variable. Linking could prevent the variable from being updated by the system. System variables include statistics results (such as *Stat.RegEqn*, *Stat.dfError*, and *Stat.Resid*) and finance-solver variables (such as *tvm.n*, *tvm.pmt*, and *tvm.fv*).

Working with Rows and Columns of Data

Selecting a row or column

- ▶ To select a column, move to the top of the column and click the column reference letter. To select a row, move to the leftmost cell of the row and click the row reference number. Press **Esc** to cancel the selection.

Handheld: Hold down ▲ to move past the top cell, or hold down ◀ to move past the leftmost cell.

- ▶ To extend a selection to adjacent rows or columns, hold down **Shift** and press ◀, ▶, ▲, or ▼.

Resizing a Row or Column

1. Click the row or column that you want to resize.
2. From the **Actions** menu, select **Resize**, and then select an option.
3. Choose a resizing option for a column or row.
 - For a column, choose **Resize Column Width**, **Maximize Column Width**, or **Minimize Column Width**.
 - For a row, you can choose **Resize Row Height**.

The tools that minimize and maximize the column width work automatically. You must manually adjust the size to use the **Resize Column Width** and **Resize Row Height** tools.
4. To resize manually, use ◀ and ▶ to resize the column, or use ▲ and ▼ to resize the row, and then press **Enter**.

Inserting an Empty Row or Column



1. Click a column or row where you want to insert the new data.
2. From the **Insert** menu, select either **Row** or **Column**.
 - If you are inserting a row, the remaining rows shift down to create space for the new row.
 - If you are inserting a column, the remaining columns shift right to create space.

Note: If other cells contain formulas with relative references to a displaced row or column, those references adjust accordingly.

Deleting Entire Rows or Columns

You can delete a row, column, group of rows, or group of columns. When you delete a row or column, the remaining rows or columns move up or left to fill the gap.

1. Click the column or row that you want to delete.

- (Optional) To select adjacent rows or columns to delete, hold down **Shift** and press ◀, ▶, ▲, or ▼.
- Display the context menu.
 - Windows®: Right-click the selected row.
 - Mac®: Hold the ⌘ key, and click the selected row.
 - Handheld: Press  .

- On the context menu, select **Delete Row**.

The selected rows or columns are deleted.

Note: If other cells contain formulas that refer to the deleted row or column, those cells show an error. Relative references to cells whose positions have changed because of a deletion adjust accordingly.

Copying Rows or Columns

- Click the row number to copy a row, or click the column letter to copy a column.
- (Optional) To select adjacent rows or columns to copy, hold down **Shift** and press ◀, ▶, ▲, or ▼.

- Copy the row or column:

Windows®: Press **Ctrl+C**.

Mac®: Press **⌘+C**.

Handheld: Press  .

- Move to any cell in the row or column where you want to place the copied items.

- Paste the row or column:

Windows®: Press **Ctrl+V**.

Mac®: Press **⌘+V**.

Handheld: Press  .

The copied row or column is pasted in place, replacing the previous contents.

Note: If you copy a named column, it is pasted with the name removed to prevent a variable conflict.

Moving a Column

1. Click the column that you want to move.
2. From the **Actions** menu, select **Move Column**.

An insertion bar appears.

3. Press ◀ and ▶ to place the insertion bar at the column's new position, and then press **Enter**.

Note: Relative references to any cell in a position is affected by the move adjust accordingly.

Displaying Results as Exact or Approximate

You can choose to display a column's calculated results in Exact (fraction) or Approximate (decimal) form. This affects only the values calculated from a formula.

1. Select the column by clicking the reference letter at the top of the column.
Handheld: Hold down ▲ to move past the top cell.
2. Display the context menu for the column.
3. On the context menu, click either **Data > Exact** or **Data > Approximate**.

Note: To restore the column results to the document's default setting, select the column and click **Data > Restore Document Setting**.

Clearing Column Data

The Clear Data command lets you remove the data from selected columns. Clear Data does not delete the column, and it does not clear a column's name or formula.

After clearing the data, Lists & Spreadsheet recalculates column formulas for the selected columns. This makes Clear Data useful for capturing a fresh set of data from another application or selectively generating a fresh column of random numbers.

1. Click the column or columns that you want to clear.
2. From the **Data** menu, select **Clear Data**.

Note: If a recalculated formula produces the same data as before, it may appear that the Clear Data command has failed.

Sorting Data

You can sort a selected area of the spreadsheet in ascending or descending order. You select which column in the selected area will be used as the key for the sort. When the sort moves data up or down in the key column, the corresponding data in the other selected columns is also moved up or down. This preserves the integrity of each row.

Note: Sorting is based on numeric values. If you select a key column that contains text, you could get unexpected results.

1. Select the range of cells.

	A	B	C	D	E
=					
1		1 sue	345	1	
2		2 bob	299	2	
3		3 lori	601	3	
4		4 burt	445	4	
5		5 jean	563	5	
6					

2. From the **Actions** menu, select **Sort**.
The **Sort** dialog box opens.
3. Click the column letter to use for ordering.
4. Click **Descending** or **Ascending** as the sort method, and then click **OK**.

	A	B	C	D	E
=					
1		5 jean	563	1	
2		4 burt	445	2	
3		3 lori	601	3	
4		2 bob	299	4	
5		1 sue	345	5	
6					

Note: Sorting a column that is defined by a formula will remove the formula, because it may not be valid after the sort.

Generating Columns of Data

You can create a column of values based on the contents of another column. You can also create a column based on any of several types of sequential data.

Entering a formula in a column's formula cell tells the Lists & Spreadsheet application that you want to apply the formula to all cells in the column, not just to a single cell.

	①	②	③	
A	B	C	D	
=	=xbar*2	=a[]/2	=seqn(u(n-1)+u(n	
1	1.	25.	0.5	1.
2	5.	25.	2.5	5.
3	15.	25.	7.5	6.
4	45.	25.	22.5	11.
5	7.	25.	3.5	17.
6		25.		28.
7		25.		45.

D1 =seqn(u(n-1)+u(n-2),{1,5})

- ① Column formula based on a variable
- ② Column formula based on another column (column A)
- ③ Column formula that generates a sequence

Notes:

- If you generate data in a column that already contains one or more cell values, Lists & Spreadsheet asks for confirmation before replacing the existing values. Proceeding removes all of the existing values in the column.
- If you edit a cell manually in a column of generated data, Lists & Spreadsheet asks for confirmation before replacing the generated data. Proceeding removes the generated data for the entire column.

Creating Column Values Based on Another Column

1. Click the column formula cell (the second cell from the top) of the column where you want to use a formula.

Lists & Spreadsheet inserts the leading equal sign (=) for the formula. If the column is a named list, Lists & Spreadsheet inserts *listname:=* followed by the cursor.

2. Type the expression for the formula after the = and press **Enter**. Use brackets ([]) after any column letter you include in the formula. For example, type =a[]^2 to create a column of values in which each cell is the square of the corresponding cell of column A.

Lists & Spreadsheet shows the formula in the formula cell and fills the column with the results.

	A	B
	=	=a[]^2
1	12.	144.
2	15.	225.
3	18.	324.
4	20.	400.
5	21.	441.

Generating a Column of Random Numbers

This example generates a column of 20 random integers in the range 1 through 6.

1. Click the column formula cell (the second cell from the top) of the column.
Lists & Spreadsheet inserts the leading equal sign (=) for the formula. If the column is a named list, Lists & Spreadsheet inserts *listname:=* followed by the cursor.
2. After the equal sign, type **RandInt (1 , 6 , 20)**.
Note: You can also use the Catalog or click **Data > Random > Integer** to insert the **RandInt()** function.
3. Press **Enter** to generate the numbers.

	A	B
=	=randint(1,6,20)	
1		6.
2		6.
3		1.
4		4.
5		3.

4. Generate (Recalculate) a new set of random numbers:

Windows®: Press **Ctrl+R**.

Mac®: Press **⌘+R**.

Handheld: Press **ctrl** **R**.

Generating a Numerical Sequence

1. Click any cell in the column in which you want to generate the sequence.
2. From the **Data** menu, select **Generate Sequence**.

The Sequence dialog box opens.

The image shows a dialog box titled "Sequence". It contains the following fields and values:

- Formula: $u(n) =$ []
- Initial Terms: []
- n0: 1
- nMax: 255
- nStep: 1
- Ceiling Value: []

Buttons: OK, Cancel

3. Type the **Formula** that will be applied to the column values.
4. Type any **Initial Terms** required by the sequence. Separate them with commas.
5. Type a starting value for the independent variable (**n0**).
6. Type a maximum number of values to be generated (**nMax**).
7. Type the step value (**nStep**).

- (Optional) Type a maximum value for the sequence in the **Ceiling Value** field.
- Click **OK**.

Lists & Spreadsheet shows the formula in the formula cell and fills the column with the results.

A	B	C
=seqgen(n^2,n,u,{1,255},{2},1,		
1	2.	
2	4.	
3	9.	
4	16.	
5	25.	
6	36.	

A1 =seqgen(n^2 ,n,u,{1,255},{2},1,50)

Graphing Spreadsheet Data

You can graph the data in a spreadsheet using Quick Graph or Summary Plot. Lists & Spreadsheet cells that contain no data are not represented by data points on graphs.

Using Quick Graph

You can easily create a dot plot of the data in one column or a scatter plot of two adjacent columns by using the Quick Graph feature. This feature displays the graphed data using the Data & Statistics application.

To create a scatter plot:

- Name both of the columns to declare them as lists.

A xlist	B ylist	C	D
=			
1	1.	2.	
2	2.	4.	
3	3.	8.	
4	4.	16.	
5	5.	32.	
6			

2. Select both columns.

	A xlist	B ylist	C	D
=				
1	1.	2.		
2	2.	4.		
3	3.	8.		
4	4.	16.		
5	5.	32.		
6				

3. From the **Data** menu, select **Quick Graph**.

A Data & Statistics application is added to the page with the plotted data. The leftmost of the two lists is plotted on the x axis, and the other list is plotted on the y axis.

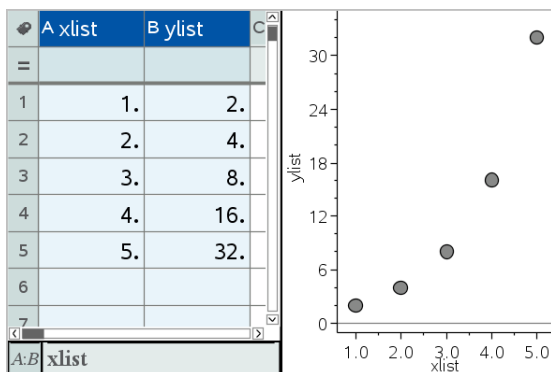

4. (Optional) Use the Data & Statistics features to analyze or visually enhance the graph.

Note: For more information, see *Using Data and Statistics*.

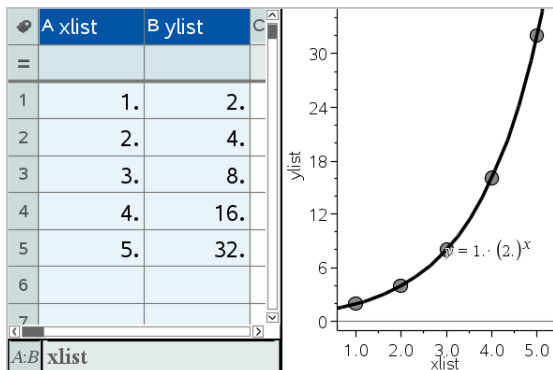

Creating a Summary Plot from a Summary Table

In this example, you create a summary table from raw data, and then use the table to generate a summary plot. For more information, see *Using Data & Statistics*.

A person	B ht	C wt	D eyecolor	E gender
=				
1	1.	56.	130. blue	f
2	2.	55.	150. blue	m
3	3.	60.	200. green	f
4	4.	62.	270. brown	m
5	5.	65.	250. brown	f
6	6.	71.	187. green	m

raw data

A color	B counts	C	D	E
=				
1	blue	3.		
2	green	3.		
3	brown	4.		
4				
5				
6				

summary table for eye color based on raw data

A summary table contains an X (or Y) List and a Summary List.

- The X (or Y) List contains numeric or string values (such as 1999 or “color”). Numeric values result in a histogram. String values identify the categories for a bar chart.
- The Summary List contains numeric values (such as count, frequency, or probability) for each element in the other list.

To Create a Summary Plot:

Note: For situations in which you already have a summary table, you can skip the first two steps.

1. Create a list that holds the category identifiers. For this example, name the list “color” and type strings for eye color. Enclose category names in quotes to prevent them from being interpreted as variables.

	A color	B	C	D
=				
1	blue			
2	green			
3	"brown"			
4				

2. Create the summary list. For this example, name the list “counts” and type the total count for each of the eye colors.

	A color	B counts	C	D
=				
1	blue	3.		
2	green	3.		
3	brown	4		
4				

3. Select either list by clicking the top cell of the column and pressing ▲.
4. From the **Data** menu, select **Summary Plot**.

The Summary Plot dialog box opens.

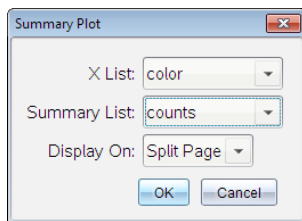

5. If necessary, use **Tab** and the arrow keys to select the correct lists for **X List** and **Summary List**.
6. In the **Display On** field, select how to display the summary plot in the Data & Statistics application.
 - Select **Split Page** to place the chart on half of the current page.
 - Select **New Page** to add the chart on a new page.

The summary plot is displayed with the list names along the axes and a summary plot symbol in the lower left corner of the chart window.

Note: In this example, the X List contains string data, so the summary plot displays as a bar chart. The category strings from the list display beneath the bars.

Exchanging Data with Other Computer Software

You can use the TI-Nspire™ desktop software to copy table data to and from software outside the TI-Nspire™ applications, such as TI DataEditor (in the TI Connect™ software) and Excel® spreadsheet software.

For example, you can copy:

- The values of individual cells, a range of cells, or an entire list from TI DataEditor.
- The values (not the underlying formulas) of individual cells, a range of cells, or an entire column from an Excel® spreadsheet.
- A number from TI DataEditor.
- The value of a matrix from TI DataEditor.

Example - Copying Data from TI DataEditor

1. Open the TI Connect™ software.
2. Display the TI DataEditor.
3. If necessary, open the file containing the number, list, or matrix that you want to copy.

	L ₆
1	1.5567
2	2.2256
3	3.987
4	7.5326
5	13.33
6	

4. Drag to select the values that you want to copy. To copy an entire list, click the top cell in the list.

	L6
1	1.5567
2	2.2256
3	3.987
4	7.5326
5	13.33
6	

- Click **Edit > Copy**.
- In Lists & Spreadsheet, click the cell where you want the data to be pasted.
If you have copied a range of cells, they will be pasted so that the upper-left corner of the range is positioned at the selected cell. Any data in those cells will be overwritten.
- Click **Edit > Paste**.

	A	B	C	D	E
=					
1		1.5567			
2		2.2256			
3		3.987			
4		7.5326			
5		13.33			
6					

Copying Cells from an Excel® Spreadsheet

You can copy up to 26 columns and 2500 rows from an Excel® spreadsheet to a Lists & Spreadsheet application.

- Drag to select the values that you want to copy from the Excel® spreadsheet. To copy an entire column, click the column identifier at the top of the column.

Note: If you select non-contiguous columns in the Excel® spreadsheet, they will be pasted as contiguous columns in Lists & Spreadsheet.

- Use the standard key shortcut for copying a selection.

Windows®: Press **Ctrl+C**.

Mac®: Press **⌘+C**.

3. In Lists & Spreadsheet, click the cells where you want the data to be pasted.

If you are copying a range of cells, they will be pasted so that the upper-left corner of the range is positioned at the selected cell. Any data in those cells will be overwritten.

4. Paste the data.

Windows®: Press **Ctrl+V**.

Mac®: Press **⌘+V**.

Handheld: Press .

Note: Categorical data must be enclosed in quotes (“ ”) after the data is pasted.

Capturing Data from Graphs & Geometry

You can use Lists & Spreadsheet application to capture information about objects in the Graphs & Geometry application. For example, you could track changes in the area of a triangle as you change the length of a side in the Graphs & Geometry application.

Captured values replace values in the column. If you prefer, you can remove all data from a column before starting a new capture by clicking **Clear Data** on the **Data** menu.

Capturing Data Manually

1. Make sure the data value that you want to capture is linked to a variable name.
2. Click the column formula cell (the second cell from the top) of the column in which you want to capture the values.

Note: Captured values replace values in the column.

3. Click **Data > Data Capture >Manual**.

A capture expression is inserted into the column formula cell with *var* as a placeholder for the name of the variable you are capturing.

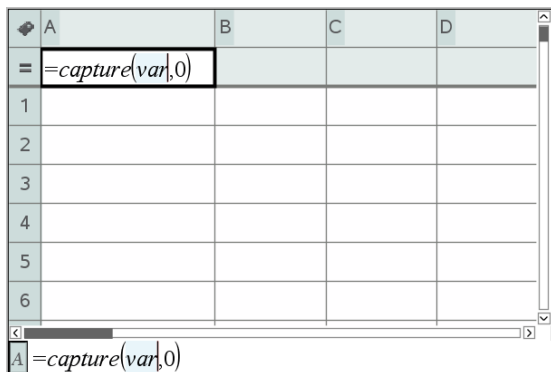

- Replace the letters “var” with the name of the variable to capture from Graphs & Geometry. For example, type **area**.

The formula cell now contains an expression similar to **=capture (area, 0)**.

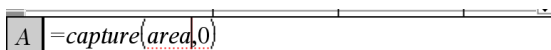

Note: The argument “0” tells Lists & Spreadsheet that you want to trigger each capture manually.

- Press **Enter**.
- From the Graphs & Geometry application, change the object with a measured value stored as the variable (area, in this example) referenced in the data capture expression.
- Each time you are ready to capture the current value of area, press the capture keys.

Windows®: Press **Ctrl+.** (the period key).

Mac®: Hold down **⌘** and press **.** (the period key).

Handheld: Press **ctrl** **.**.

The current *area* value is added to the end of the list as a list element.

Capturing Data Automatically

When you capture data automatically, you can specify that you want the captures to be triggered by:

- Changes in the captured variable only.
- Changes in the captured variable or additional variables.

This lets you set up multiple columns of synchronized captures, such as the x and y coordinates of a moving object.

1. Clear all columns that you will be using for the captured data.
2. Make sure any data values that you want to capture are linked to variable names.
3. Click the column formula cell (the second cell from the top) of the column in which you want to capture the values.
4. Click **Data >Data Capture >Automatic**.

A capture expression is inserted into the column formula cell with *var* as a placeholder for the name of the variable you are capturing.

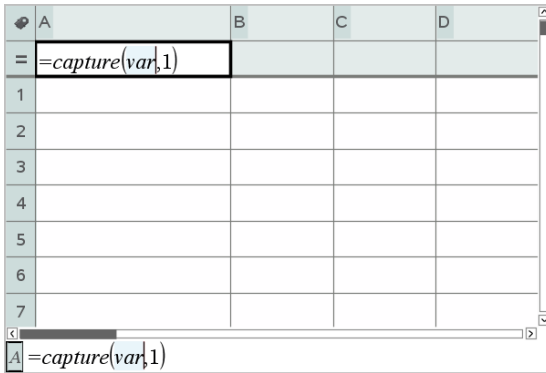

5. Replace the letters “var” with the name of the variable to capture. For example, type `objpathX`. Alternatively, you can select the variable name from the Variables menu.

The formula cell now contains an expression similar to `=capture(objpathX,1)`.



Note: The argument “1” tells Lists & Spreadsheet that you want the captures to be triggered by the variable change.

6. If you want the capture to also be triggered by changes in an additional variable or variables, type a comma after the 1, and then type the variable name or the name of a list that itemizes the variables.

The formula cell will contain an expression similar to `=capture(objpathX,1,objpathY)`.

7. Press **Enter** to complete the formula.
8. If you are capturing multiple columns of synchronized data, set up the additional columns. For example, you might set up a second capture variable using
`=capture (objpathY, 1, objpathX) .`
9. When you are ready to capture the values, begin moving the object or start the animation that affects it in Graphs & Geometry.
Each captured value is added to the end of the list.

Using Table Data for Statistical Analysis

Tools on the Statistics menu provide access to wizards that help you perform statistical analyses on the data in table columns. You specify the location of the data, and Lists & Spreadsheet stores the results in two columns: one for the result names, and one for the corresponding values.

Plotting Statistical Data

Some statistics wizards include a **Draw** check box. By default, the box is not selected. Selecting this box creates a Data & Statistics work area on the page, displays the calculated results in Lists & Spreadsheet, and draws the results of the statistical analysis in the Data & Statistics work area.

Note: For functions that support the **Draw** option, the option is available only if you type the function in a column formula cell.

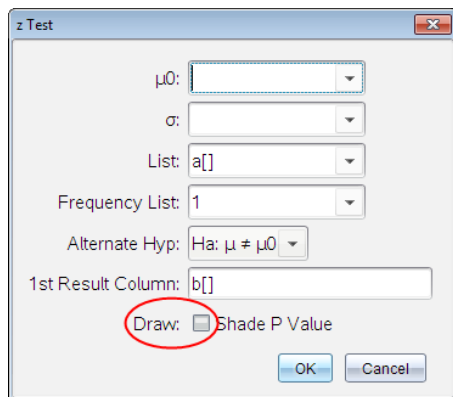

Draw check box (as shown in the **z Test** wizard).

Statistics Input Descriptions

The following table describes the different inputs used in Lists & Spreadsheet wizards.

Input	Description
μ_0	Hypothesized value of the population mean that you are testing.
σ	The known population standard deviation; must be a real number > 0 .
List	The name of the list containing the data you are testing.
Frequency List	The name of the list containing the frequency values for the data in List . Default=1. All elements must be integers ≥ 0 . The frequency values can also be typed as a list, in the format {1, 1, 3, 2}.
\bar{x} , Sx, n	Summary statistics (mean, standard deviation, and sample size) for the one-sample tests and intervals.
σ_1	The known population standard deviation from the first population for the two-sample tests and intervals. Must be a real number > 0 .
σ_2	The known population standard deviation from the second population for the two-sample tests and intervals. Must be a real number > 0 .
List 1, List 2	The names of the lists containing the data you are testing for the two-sample tests and intervals.

Input	Description
Frequency 1, Frequency 2	The names of the lists containing the frequencies for the data in List 1 and List 2 for the two-sample tests and intervals. Defaults=1. All elements must be integers ≥ 0 .
$\bar{x}1, Sx1, n1, \bar{x}2, Sx2, n2$	Summary statistics (mean, standard deviation, and sample size) for sample one and sample two in two-sample tests and intervals.
Pooled	Specifies whether variances are to be pooled for 2-Sample t Test and 2-Sample t Interval .
p_0	The expected sample proportion for 1-Prop z Test . Must be a real number, such that $0 < p_0 < 1$.
x	The count of successes in the sample for the 1-Prop z Test and 1-Prop z Interval . Must be an integer ≥ 0 .
n	The count of observations in the sample for the 1-Prop z Test and 1-Prop z Interval . Must be an integer > 0 .
x1	The count of successes from sample one for the 2-Prop z Test and 2-Prop z Interval . Must be an integer ≥ 0 .
x2	The count of successes from sample two for the 2-Prop z Test and

Input	Description
	2-Prop z Interval. Must be an integer ≥ 0 .
n1	The count of observations in sample one for the 2-Prop z Test and 2-Prop z Interval. Must be an integer > 0 .
n2	The count of observations in sample two for the 2-Prop z Test and 2-Prop z Interval. Must be an integer > 0 .
C-Level	The confidence level for the interval instructions. Must be ≥ 0 and < 100 . If it is ≥ 1 , it is assumed to be given as a percent and is divided by 100. Default=0.95.
RegEQ	The prompt for the name of the function where the calculated regression equation is to be stored.

Statistical Calculations

Performing a Statistical Calculation

You can perform statistical calculations to analyze data. The following example fits a $y=mx+b$ linear regression model to the two lists in columns A and B.

1. From the **Statistics** menu, select **Stat Calculation > LinearRegression (mx+b)** to choose the regression model.

The Linear Regression (mx+b) dialog box opens.

2. Type **a []** as the column for the **X List**.
3. Type **b []** as the column for the **Y List**.

- To store the regression equation in a specified variable, replace **Save RegEqn To** with the name of the variable.
- Type `c[]` as the column for the **1st Result**.

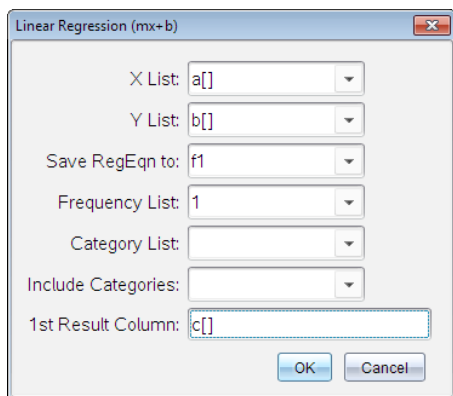

- Click **OK**.

Lists & Spreadsheet inserts two columns: one containing the names of the results, and one containing the corresponding values.

	A	B	C	D	E
=				=LinRegMx(a[],b[],1): CopyVa	
1	1	7	Title	Linear Regression (mx+b)	
2	2	12	RegEqn	m*x+b	
3	3	17	m		5.
4	4	22	b		2.
5	5	27	r ²		1.
6			r		1.
7			Resid	{0.,0.,0.,0.,0.}	
8					

`D =LinRegMx(a[],b[],1): CopyVar Stat.RegEqn,/I: CopyVa`

Note: The results are linked to the source data. For example, if you change a value in column A, the regression equation is updated automatically.

Storing Statistical Results

Lists & Spreadsheet stores statistical results using a variable-group name with the format `stat.nnn`, where `nnn` is the result name (for example, `stat.RegEqn` and `stat.Resid`). The use of standard names for variables makes it easier to

identify and use the statistical variables later. If you want to use a custom variable group instead of the standard name, you can edit the formula in the column formula cell.

You could use the following formula to store the results in the variable group **MystatsB**.

```
=LinRegMx(a[],b[],1): CopyVar Stat., MystatsB.
```

Later, you could view the results by entering the following expression in the Calculator application or in another column of the Lists & Spreadsheet application:

```
MystatsB.results
```

Supported Statistical Calculations

The **Stat Calculations** menu lets you select from the calculations described below. For more information, see the *TI-Nspire™ Reference Guide*.

One-Variable Statistics (OneVar)

Analyzes data with one measured variable. You can specify an optional frequency list. The statistical data returned using this analysis technique are:

- Sample mean, \bar{x}
- Sum of the data, Σx
- Sum of the squared data, Σx^2
- Sample standard deviation, s_x
- Population standard deviation, σ_x
- Sample size, n
- X-min
- First quartile, Q_1
- Median
- Third quartile, Q_3
- X-max
- Sum of squared deviations, $SSx = \Sigma(x - \bar{x})^2$

Two-Variable Statistics (TwoVar)

Analyzes paired data. *List 1* is the independent variable. *List 2* is the dependent variable. You can specify an optional frequency list. The statistical data returned using this analysis technique are:

For each list:

- Sample mean, \bar{x} or \bar{y}
- Sum of the data, Σx or Σy
- Sum of the squared data, Σx^2 or Σy^2
- Sample standard deviation, $s_x = s_{n-1}x$ or $s_y = s_{n-1}y$
- Population standard deviation, $\sigma_x = \sigma_n x$ or $\sigma_y = \sigma_n y$
- X-min or Y-min
- First quartile, Q_1X or Q_1Y
- Median
- Third quartile, Q_3X or Q_3Y
- X-max or Y-max
- Sum of squared deviations, $SSx = \Sigma(x - \bar{x})^2$ or $SSy = \Sigma(y - \bar{y})^2$

Additional data:

- Sample size for each data set, n
- Σxy
- Correlation coefficient, R .

Linear Regression ($mx+b$) (LinRegMx)

Fits the model equation $y=ax+b$ to the data using a least-squares fit. It displays values for **m** (slope) and **b** (y-intercept).

Linear Regression ($a+bx$) (LinRegBx)

Fits the model equation $y=a+bx$ to the data using a least-squares fit. It displays values for **a** (y-intercept), **b** (slope), r^2 , and **r**.

Median-Median Line (MedMed)

Fits the model equation $y=mx+b$ to the data using the median-median line (resistant line) technique, calculating the summary points $x_1, y_1, x_2, y_2, x_3,$ and y_3 . **Median-Median Line** displays values for **m** (slope) and **b** (y-intercept).

Quadratic Regression (QuadReg)

Fits the second-degree polynomial $y=ax^2+bx+c$ to the data. It displays values for **a**, **b**, **c**, and R^2 . For three data points, the equation is a polynomial fit; for four or more, it is a polynomial regression. At least three data points are required.

Cubic Regression (CubicReg)

Fits the third-degree polynomial $y=ax^3+bx^2+cx+d$ to the data. It displays values for **a**, **b**, **c**, **d**, and R^2 . For four points, the equation is a polynomial fit; for five or more, it is a polynomial regression. At least four points are required.

Quartic Regression (QuartReg)

Fits the fourth-degree polynomial $y=ax^4+bx^3+cx^2+dx+e$ to the data. It displays values for **a**, **b**, **c**, **d**, **e**, and R^2 . For five points, the equation is a polynomial fit; for six or more, it is a polynomial regression. At least five points are required.

Power Regression (PowerReg)

Fits the model equation $y=ax^b$ to the data using a least-squares fit on transformed values $\ln(x)$ and $\ln(y)$. It displays values for **a**, **b**, r^2 , and **r**.

Exponential Regression (ExpReg)

Fits the model equation $y=ab^x$ to the data using a least-squares fit on transformed values x and $\ln(y)$. It displays values for **a**, **b**, r^2 , and **r**.

Logarithmic Regression (LogReg)

Fits the model equation $y=a+b \ln(x)$ to the data using a least-squares fit on transformed values $\ln(x)$ and y . It displays values for **a**, **b**, r^2 , and **r**.

Sinusoidal Regression (SinReg)

Fits the model equation $y=a \sin(bx+c)+d$ to the data using an iterative least-squares fit. It displays values for **a**, **b**, **c**, and **d**. At least four data points are required. At least two data points per cycle are required to avoid aliased frequency estimates.

Note: The output of **SinReg** is always in radians, regardless of the Radian/Degree mode setting.

Logistic Regression (d=0) (Logistic)

Fits the model equation $y=c/(1+a \cdot e^{-bx})$ to the data using an iterative least-squares fit. It displays values for **a**, **b**, and **c**.

Logistic Regression (d≠0) (LogisticD)

Fits the model equation $y=c(1+a*e^{-bx})+d$ to the data using an iterative least-squares fit. It displays values for **a**, **b**, **c** and **d**.

Multiple Linear Regression (MultReg)

Calculates multiple linear regression of list Y on lists X1, X2, ..., X10.

Distributions

Calculating a Distribution

Example: Calculate a distribution to fit the Normal Pdf distribution model.

1. Click the column formula cell (second cell from the top) in column A.
2. Click **Statistics > Distributions > Normal Pdf** to choose the Distribution model.

The Normal Pdf dialog box opens and displays fields for typing or selecting the arguments for the calculation.

- Press **Tab** as necessary to move from field to field and provide each argument. You can type values, or select them from the drop down list:
 - **X Value:** Click the drop-down arrow to choose any list in the problem to provide the x values for the calculation.
 - **Mean:** Type a value for the mean or click the drop-down arrow to choose a variable that contains the mean.
 - **Standard Deviation:** Type a value for the standard deviation or choose a variable that contains the standard deviation.
3. Click the **Draw** check box to see the distribution plotted in Data & Statistics.
Note: The Draw option is not available for all distributions.
 4. Click **OK**.

Lists & Spreadsheet inserts two columns: one containing the names of the results, and one containing the corresponding values. The results are plotted in Data & Statistics.

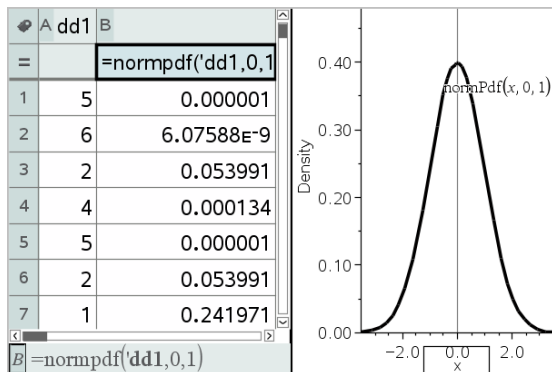

Note: The results are linked to the source data. For example, you can change a value in Column A, and the equation updates automatically.

Supported Distribution Functions

The following distributions are available from the Lists & Spreadsheet application. For more information regarding these functions, see the *TI-Nspire™ Reference Guide*.

- To return a single distribution result based on a single value, type the function in a single cell.
- To return a list of distribution results based on a list of values, type the function in a column formula cell. In this case, you specify a list (column) that contains the values. For each value in the list, the distribution returns a corresponding result.

Note: For distribution functions that support the draw option (**normPDF**, **t PDF**, **χ^2 Pdf**, and **F Pdf**), the option is available only if you type the distribution function in a formula cell.

Normal Pdf (*normPdf*)

Computes the probability density function (**pdf**) for the normal distribution at a specified x value. The defaults are mean $\mu=0$ and standard deviation $\sigma=1$. The probability density function (pdf) is:

$$f(x) = \frac{1}{\sqrt{2\pi\sigma}} e^{-\frac{(x-\mu)^2}{2\sigma^2}}, \sigma > 0$$

This distribution is used to determine the probability of the occurrence of a certain value in a normal distribution. The draw option is available when Normal PDF is invoked from a formula cell.

When you access distributions from the formula cell, you must select a valid list from the drop-down list to avoid unexpected results. If accessed from a cell, you must specify a number for the x-value. The distribution returns the probability that the value you specify will occur.

Normal Cdf (normCdf)

Computes the normal distribution probability between *Lower Bound* and *Upper Bound* for the specified mean, μ (default=0) and the standard deviation, σ (default=1). You can click the **Draw (Shade area)** check box to shade the area between the lower and upper bounds. Changes to the initial *Lower Bound* and *Upper Bound* automatically update the distribution.

This distribution is useful in determining the probability of an occurrence of any value between the lower and upper bounds in the normal distribution. It is equivalent to finding the area under the specified normal curve between the bounds.

Inverse Normal (invNorm)

Computes the inverse cumulative normal distribution function for a given *area* under the normal distribution curve specified by mean, μ , and standard deviation, σ .

This distribution is useful in determining the x-value of data in the area from 0 to $x < 1$ when the percentile is known.

t Pdf (tPdf)

Computes the probability density function (**pdf**) for the t-distribution at a specified x value. df (degrees of freedom) must be > 0 . The probability density function (**pdf**) is:

$$f(x) = \frac{\Gamma[(df+1)/2]}{\Gamma(df/2)} \frac{(1+x^2/df)^{-(df+1)/2}}{\sqrt{\pi df}}$$

This distribution is useful in determining the probability of the occurrence of a value when the population standard deviation is not known and the sample size is small. The draw option is available when **t Pdf** is invoked from a formula cell.

t Cdf (tCdf)

Computes the Student-t distribution probability between *Lower Bound* and *Upper Bound* for the specified *df* (degrees of freedom). You can click the **Draw (Shade area)** check box to shade the area between the bounds. Changes to the initial *Lower Bound* and *Upper Bound* automatically update the distribution.

This distribution is useful in determining the probability of the occurrence of a value within an interval defined by the lower and upper bound for a normally distributed population when the population standard deviation is not known.

Inverse t (invt)

Computes the inverse cumulative t-distribution probability function specified by Degrees of Freedom, *df*, for a given area under the curve.

This distribution is useful in determining the probability of an occurrence of data in the area from 0 to $x < 1$. This function is used when the population mean and/or population standard deviation is not known.

χ^2 Pdf (χ^2 Pdf())

Computes the probability density function (**pdf**) for the χ^2 (chi-square) distribution at a specified *x* value. *df* (degrees of freedom) must be an integer > 0 . The probability density function (**pdf**) is:

$$f(x) = \frac{1}{\Gamma(df/2)} (1/2)^{df/2} x^{df/2-1} e^{-x/2}, x \geq 0$$

This distribution is useful in determining the probability of the occurrence of a given value from a population with a χ^2 distribution. The draw option is available when χ^2 Pdf is invoked from a formula cell.

χ^2 Cdf (χ^2 Cdf())

Computes the χ^2 (chi-square) distribution probability between *lowBound* and *upBound* for the specified *df* (degrees of freedom). You can click the **Draw Shade area** check box to shade the area between the lower and upper bounds. Changes to the initial *lowBound* and *upBound* automatically update the distribution.

This distribution is useful in determining the probability of the occurrence of value within given boundaries of a population with a χ^2 distribution.

F Pdf (F Pdf())

Computes the probability density function (**pdf**) for the F distribution at a specified x value. *numerator df* (degrees of freedom) and *denominator df* must be integers > 0 . The probability density function (**pdf**) is:

$$f(x) = \frac{\Gamma[(n+d)/2]}{\Gamma(n/2)\Gamma(d/2)} \left(\frac{n}{d}\right)^{n/2} x^{n/2-1} (1+nx/d)^{-(n+d)/2}, x \geq 0$$

where n = numerator degrees of freedom
 d = denominator degrees of freedom

This distribution is useful in determining the probability that two samples have the same variance. The draw option is available when F Pdf is invoked from a formula cell.

F Cdf (F Cdf())

Computes the F distribution probability between *lowBound* and *upBound* for the specified *dfnumer* (degrees of freedom) and *dfDenom*. You can click the **Draw (Shade area)** check box to shade the area between the lower and upper bounds. Changes to the initial *lowBound* and *upBound* automatically update the distribution.

This distribution is useful in determining the probability that a single observation falls within the range between the lower bound and upper bound.

Binomial Pdf (binomPdf())

Computes a probability at x for the discrete binomial distribution with the specified *numtrials* and probability of success (p) on each trial. The x parameter can be an integer or a list of integers. $0 \leq p \leq 1$ must be true. *numtrials* must be an integer > 0 . If you do not specify x , a list of probabilities from 0 to *numtrials* is returned. The probability density function (**pdf**) is:

$$f(x) = \binom{n}{x} p^x (1-p)^{n-x}, x = 0, 1, \dots, n$$

where n = *numtrials*

This distribution is useful in determining the probability of success in a success/failure trial, at trial n . For example, you could use this distribution to predict the probability of getting heads in a coin toss on the fifth toss.

Binomial Cdf (binomCdf())

Computes a cumulative probability for the discrete binomial distribution with n number of trials and probability p of success on each trial.

This distribution is useful in determining the probability of a success on one trial before all trials are completed. For example, if heads is a successful coin toss and you plan to toss the coin 10 times, this distribution would predict the chance of obtaining heads at least once in the 10 tosses.

Poisson Pdf (poissPdf())

Computes a probability at x for the discrete Poisson distribution with the specified mean, μ , which must be a real number > 0 . x can be an integer or a list of integers. The probability density function (pdf) is:

$$f(x) = e^{-\mu} \mu^x / x!, x = 0, 1, 2, \dots$$

This distribution is useful in determining the probability of obtaining a certain number of successes before a trial begins. For example, you could use this calculation to predict the number of heads that would occur in eight tosses of a coin.

Poisson Cdf (poissCdf())

Computes a cumulative probability for the discrete Poisson distribution with specified mean, \bar{x} .

This distribution is useful in determining the probability that a certain number of successes occur between the upper and lower bounds of a trial. For example, you could use this calculation to predict the number of heads displayed between coin toss #3 and toss #8.

Geometric Pdf (geomPdf())

Computes a probability at x , the number of the trial on which the first success occurs, for the discrete geometric distribution with the specified probability of success p . $0 \leq p \leq 1$ must be true. x can be an integer or a list of integers. The probability density function (pdf) is:

$$f(x) = p(1-p)^{x-1}, x = 1, 2, \dots$$

This distribution is useful in determining the likeliest number of trials before a success is obtained. For example, you could use this calculation to predict the number of coin tosses that would be made before a heads resulted.

Geometric Cdf (geomCdf())

Computes a cumulative geometric probability from lowBound to upBound with the specified probability of success, p .

This distribution is useful in determining the probability associated with the first success occurring during trials 1 through n . For example, you could use this calculation to determine the probability that heads display on toss #1, #2, #3, ..., # n .

Confidence Intervals

Supported Confidence Intervals

The following confidence intervals are available from the Lists & Spreadsheets application. For more information regarding these functions, see the *TI-Nspire™ Reference Guide*.

***z* Interval (*zInterval*)**

Computes a confidence interval for an unknown population mean, μ , when the population standard deviation, σ , is known. The computed confidence interval depends on the user-specified confidence level.

This test is useful in determining how far from a population mean a sample mean can get before indicating a significant deviation.

***t* Interval (*tInterval*)**

Computes a confidence interval for an unknown population mean, μ , when the population standard deviation, σ , is unknown. The computed confidence interval depends on the user-specified confidence level.

This test is useful in examining whether the confidence interval associated with a confidence level contains the value assumed in the hypothesis. Like the *z* Interval, this test helps you determine how far from a population mean a sample mean can get before indicating a significant deviation when the population mean is unknown.

***2-Sample z* Interval (*zInterval_2Samp*)**

Computes a confidence interval for the difference between two population means ($\mu_1 - \mu_2$) when both population standard deviations (σ_1 and σ_2) are known. The computed confidence interval depends on the user-specified confidence level.

This test is useful in determining if there is statistical significance between the means of two samples from the same population. For example, this test could determine whether there is significance between the mean college entrance test score of female students and the mean of college entrance test score of male students at the same school.

2-Sample t Interval (tInterval_2Samp)

Computes a confidence interval for the difference between two population means ($\mu_1 - \mu_2$) when both population standard deviations (σ_1 and σ_2) are unknown. The computed confidence interval depends on the user-specified confidence level.

This test is useful in determining if there is statistical significance between the means of two samples from the same population. It is used instead of the 2-sample z confidence interval in situations where the population is too large to measure to determine the standard deviation.

1-Prop z Interval (zInterval_1Prop)

Computes a confidence interval for an unknown proportion of successes. It takes as input the count of successes in the sample x and the count of observations in the sample n . The computed confidence interval depends on the user-specified confidence level.

This test is useful in determining the probability of a given number of successes that can be expected for a given number of trials. For instance, casino examiners would use this test to determine if observed payouts for one slot machine demonstrate a consistent pay out rate.

2-Prop z Interval (zInterval_2Prop)

Computes a confidence interval for the difference between the proportion of successes in two populations ($p_1 - p_2$). It takes as input the count of successes in each sample (x_1 and x_2) and the count of observations in each sample (n_1 and n_2). The computed confidence interval depends on the user-specified confidence level.

This test is useful in determining if two rates of success differ because of something other than sampling error and standard deviation. For example, a bettor could use this test to determine if there is an advantage in the long run by playing one game or machine versus playing another game or machine.

Linear Reg t Intervals (LinRegtIntervals)

Computes a linear regression t confidence interval for the slope coefficient b . If the confidence interval contains 0, this is insufficient evidence to indicate that the data exhibits a linear relationship.

Multiple Reg Intervals (MultRegIntervals)

Computes multiple regression prediction confidence interval for the calculated y and a confidence for y .

Stat Tests

Supported Statistical Tests

Hypothesis tests are available from the Lists & Spreadsheets application. For more information regarding these functions, see the *TI-Nspire™ Reference Guide*.

Some of the wizards for Stat Tests display a **Draw** check box. By default, the box is not selected. Selecting the box creates a Data & Statistics work area on the page and plots the results in that work area.

z test (zTest)

Performs a hypothesis test for a single unknown population mean, μ , when the population standard deviation, σ , is known. It tests the null hypothesis $H_0: \mu = \mu_0$ against one of the alternatives below.

- $H_a: \mu \neq \mu_0$
- $H_a: \mu < \mu_0$
- $H_a: \mu > \mu_0$

This test is used for large populations that are normally distributed. The standard deviation must be known.

This test is useful in determining if the difference between a sample mean and a population mean is statistically significant when you know the true deviation for a population.

t test (tTest)

Performs a hypothesis test for a single unknown population mean, μ , when the population standard deviation, σ , is unknown. It tests the null hypothesis $H_0: \mu = \mu_0$ against one of the alternatives below.

- $H_a: \mu \neq \mu_0$
- $H_a: \mu < \mu_0$
- $H_a: \mu > \mu_0$

This test is similar to a z-test, but is used when the population is small and normally distributed. This test is used more frequently than the z-test because small sample populations are more frequently encountered in statistics than are large populations.

This test is useful in determining if two normally distributed populations have equal means, or when you need to determine if a sample mean differs from a population mean significantly and the population standard deviation is unknown.

2-Sample z Test (zTest_2Samp)

Tests the equality of the means of two populations (μ_1 and μ_2) based on independent samples when both population standard deviations (σ_1 and σ_2) are known. The null hypothesis $H_0: \mu_1 = \mu_2$ is tested against one of the alternatives below.

- $H_a: \mu_1 \neq \mu_2$
- $H_a: \mu_1 < \mu_2$
- $H_a: \mu_1 > \mu_2$

2-Sample t Test (tTest_2Samp)

Tests the equality of the means of two populations (μ_1 and μ_2) based on independent samples when neither population standard deviation (σ_1 or σ_2) is known. The null hypothesis $H_0: \mu_1 = \mu_2$ is tested against one of the alternatives below.

- $H_a: \mu_1 \neq \mu_2$
- $H_a: \mu_1 < \mu_2$
- $H_a: \mu_1 > \mu_2$

1-Prop z Test (zTest_1Prop)

Computes a test for an unknown proportion of successes (prop). It takes as input the count of successes in the sample x and the count of observations in the sample n . **1-Prop z Test** tests the null hypothesis $H_0: \text{prop} = p_0$ against one of the alternatives below.

- $H_a: \text{prop} \neq p_0$
- $H_a: \text{prop} < p_0$
- $H_a: \text{prop} > p_0$

This test is useful in determining if the probability of the success seen in a sample is significantly different from the probability of the population or if it is due to sampling error, deviation, or other factors.

2-Prop z Test (zTest_2Prop)

Computes a test to compare the proportion of successes (p_1 and p_2) from two populations. It takes as input the count of successes in each sample (x_1 and x_2) and the count of observations in each sample (n_1 and n_2). **2-Prop z Test** tests the null hypothesis $H_0: p_1=p_2$ (using the pooled sample proportion \bar{C}) against one of the alternatives below.

- $H_a: p_1 \neq p_2$
- $H_a: p_1 < p_2$
- $H_a: p_1 > p_2$

This test is useful in determining if the probability of success seen in two samples is equal.

χ^2 GOF (χ^2 GOF)

Performs a test to confirm that sample data is from a population that conforms to a specified distribution. For example, χ^2 GOF can confirm that the sample data came from a normal distribution.

χ^2 2-way Test (χ^2 2way)

Computes a chi-square test for association on the two-way table of counts in the specified *Observed* matrix. The null hypothesis H_0 for a two-way table is: no association exists between row variables and column variables. The alternative hypothesis is: the variables are related.

2-Sample F Test (FTest_2Samp)

Computes an F-test to compare two normal population standard deviations (σ_1 and σ_2). The population means and standard deviations are all unknown.

2-Sample F Test, which uses the ratio of sample variances $Sx1^2/Sx2^2$, tests the null hypothesis $H_0: \sigma_1=\sigma_2$ against one of the alternatives below.

- $H_a: \sigma_1 \neq \sigma_2$
- $H_a: \sigma_1 < \sigma_2$
- $H_a: \sigma_1 > \sigma_2$

Below is the definition for the **2-Sample F Test**.

$Sx1, Sx2$ = Sample standard deviations having n_1-1 and n_2-1 degrees of freedom *df*, respectively.

$$F = \text{F-statistic} = \left(\frac{Sx1}{Sx2} \right)^2$$

$df(x, n_1 - 1, n_2 - 1)$ = Fpdf() with degrees of freedom $df, n_1 - 1$, and $n_2 - 1$

p = reported p value

2-Sample FTest for the alternative hypothesis $\sigma_1 > \sigma_2$.

$$p = \int_F^{\alpha} f(x, n_1 - 1, n_2 - 1) dx$$

2-Sample FTest for the alternative hypothesis $\sigma_1 < \sigma_2$.

$$p = \int_0^F f(x, n_1 - 1, n_2 - 1) dx$$

2-Sample FTest for the alternative hypothesis $\sigma_1 \neq \sigma_2$. Limits must satisfy the following:

$$\frac{p}{2} = \int_0^{L_{bnd}} f(x, n_1 - 1, n_2 - 1) dx = \int_{U_{bnd}}^{\infty} f(x, n_1 - 1, n_2 - 1) dx$$

where: $[L_{bnd}, U_{bnd}]$ = lower and upper limits

The F-statistic is used as the bound producing the smallest integral. The remaining bound is selected to achieve the preceding integral's equality relationship.

Linear Reg t Test (LinRegTTest)

Computes a linear regression on the given data and a t test on the value of slope β and the correlation coefficient ρ for the equation $y = \alpha + \beta x$. It tests the null hypothesis $H_0: \beta = 0$ (equivalently, $\rho = 0$) against one of the alternatives below.

- $H_a: \beta \neq 0$ and $\rho \neq 0$
- $H_a: \beta < 0$ and $\rho < 0$
- $H_a: \beta > 0$ and $\rho > 0$

Multiple Reg Tests (MultRegTest)

Computes a linear regression on the given data, and provides the F test statistic for linearity.

For more information, see the *TI-Nspire™ Reference Guide*.

ANOVA (ANOVA)

Computes a one-way analysis of variance for comparing the means of 2 to 20 populations. The ANOVA procedure for comparing these means involves analysis of the variation in the sample data. The null hypothesis

$H_0: \mu_1 = \mu_2 = \dots = \mu_k$ is tested against the alternative H_a : not all μ_1, \dots, μ_k are equal.

The ANOVA test is a method of determining if there is a significant difference between the groups as compared to the difference occurring within each group.

This test is useful in determining if the variation of data from sample-to-sample shows a statistically significant influence of some factor other than the variation within the data sets themselves. For example, a box buyer for a shipping firm wants to evaluate three different box manufacturers. He obtains sample boxes from all three suppliers. ANOVA can help him determine if the differences between each sample group are significant as compared to the differences within each sample group.

ANOVA 2-Way (ANOVA2way)

Computes a two-way analysis of variance for comparing the means of two to 20 populations. A summary of results is stored in the *stat.results* variable.

The two-way ANOVA analysis of variance examines the effects of two independent variables and helps to determine if these interact with respect to the dependent variable. (In other words, if the two independent variables do interact, their combined effect can be greater than or less than the impact of either independent variable additively.)

This test is useful in evaluating differences similar to the ANOVA analysis but with the addition of another potential influence. To continue with the ANOVA box example, the two-way ANOVA might examine the influence of box material on the differences seen.

Selecting an Alternative Hypothesis ($\neq < >$)

Most of the inferential stat editors for the hypothesis tests prompt you to select one of three alternative hypotheses.

- The first is a \neq alternative hypothesis, such as $\mu \neq \mu_0$ for the **z Test**.
- The second is a $<$ alternative hypothesis, such as $\mu_1 < \mu_2$ for the **2-Sample t Test**.
- The third is a $>$ alternative hypothesis, such as $p_1 > p_2$ for the **2-Prop z Test**.

To select an alternative hypothesis, move the cursor to the appropriate alternative, and then press **Enter**.

Selecting the Pooled Option

Pooled (2-Sample t Test and 2-Sample t Interval) only) specifies whether the variances are to be pooled for the calculation.

- Select **No** if you do not want the variances pooled. Population variances can be unequal.
- Select **Yes** if you want the variances pooled. Population variances are assumed to be equal.

To select the **Pooled** option, select Yes from the drop-down list.

Working with Function Tables

The Lists & Spreadsheet application lets you show a table of function values for any function in the current problem. You can change the settings for the table, delete columns, add values for multiple functions, and edit the expression that defines a function without leaving the Lists & Spreadsheet application.

Switching to a Table

1. While working in the Lists & Spreadsheet application:

Windows: Press **Ctrl+T**.

Mac®: Press **⌘+T**.

Handheld: Press .

The Lists & Spreadsheet application disappears and an empty table is displayed with a list of the functions that are available in the problem.

Note: If you have previously shown a table for a function from the Lists & Spreadsheet application, the table includes that function by default.

2. Choose the name of the function for which you want to display values.
Values for the function you selected are displayed in the first column of the table.
3. To move through adjacent cells of the table, press **▲** or **▼**. Press **Tab** to move from the body of the table (cells) to the top two rows (cells for column names and formulas).

4. To hide the table of values and return to the Lists & Spreadsheet application, repeat Step 1.

Making Changes from a Table

You can change the table of function values using the tools on the **Table** menu.

- ▶ To remove a column from the table, click any cell and click **Delete Column**.
- ▶ To display the list of functions, click a cell in a column and click **Choose**. Select a cell in an empty column unless you are replacing values already displayed. Click a function in the list to add its values to the column.
Note: You can also click the drop-down arrow on the top cell of a column to display the list of functions in the problem.
- ▶ To change the expression that defines a function, click **Edit Expression**. You can also edit the expression directly on the entry line beneath the table.
Note: When you edit the expression for a function, that function automatically changes in the application used to define the function. For example, if you edit a Graphs & Geometry function in the table, the table values and graph of the function are both updated.
- ▶ To change the default table settings, choose **Edit Table Settings**.
The Table dialog box opens. Press **Tab** to move from field to field and type or select new values for the default table settings:
 - **Table Start:** Type the value to use as the first value in the table of values.
 - **Table Step:** Type a value for the interval between values.
 - **Independent and Dependent:** Click the drop-down arrow to choose **Auto** or **Ask** as the method for populating a column with the values of the independent and dependent variables. **Auto** populates the table starting at the defined table start value and displays an independent and dependent value for each step. **Ask** lets you select a cell and press **Enter** to generate a value for a cell.

Data & Statistics Application

The Data & Statistics application provides tools to:

- Visualize sets of data in different types of plots.
- Directly manipulate variables to explore and visualize data relationships. Data changes in one application are dynamically applied to all linked applications.
- Explore central tendency and other statistical summary techniques.
- Fit functions to data.
- Create regression lines for scatter plots.
- Graph hypothesis tests and results (z- and t-tests) based on summary statistics definitions or data.

Adding a Data & Statistics Page

- ▶ To start a new document with a blank Data & Statistics page:

From the main **File** menu, click **New Document**, and then click **Add Data & Statistics**.

Handheld: Press **[on]**, and select **Data & Statistics** .

- ▶ To add a Data & Statistics page in the current problem of an existing document:

From the toolbar, click **Insert > Data & Statistics**.

Handheld: Press **[doc]** and select **Insert > Data & Statistics**.

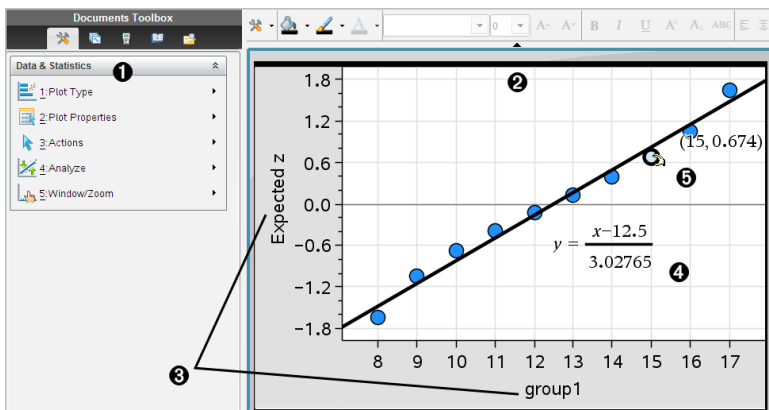

- ❶ Data & Statistics menu
- ❷ Work area
- ❸ **Add Variable** regions on x-axis and y-axis
- ❹ Normal Probability Plot with expression
- ❺ Data point with coordinates

Basic Operations in Data & Statistics

The Data & Statistics application lets you explore and visualize data and graph inferential statistics. The Lists & Spreadsheet application can work in conjunction with the Data & Statistics application. The Lists & Spreadsheet Summary Plot and Quick Graph tools automatically add a Data & Statistics application to show plots. A list that you create in a problem (using the Lists & Spreadsheet or Calculator applications) can be accessed as a variable in any TI-Nspire™ application in that problem.

Using the Default Caseplot

The Data & Statistics application plots numeric and string (categorical) data from variables. When you add a Data & Statistics application to a problem that includes lists, a default caseplot displays on the work area.

The caseplot is like having a stack of cards with information on them and scattering the cards randomly on a table. You can click a dot to see the information on that “card.” You can drag a dot to “group” the “cards” by the caption variable.

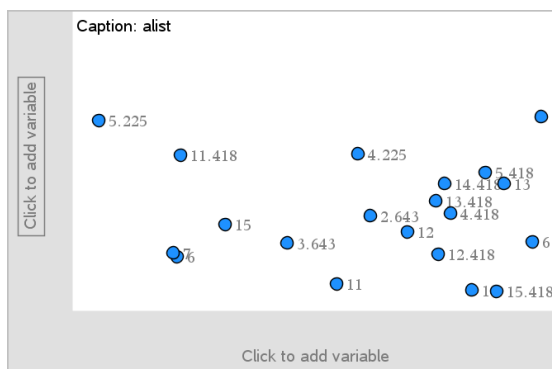

- ▶ Click the variable name displayed after **Caption** to use the caseplot.

- Choose <None> to remove the default caseplot.
- Choose the name of a variable to have it replace the current caseplot variable.
- Hover over any data point to see the summary information.
- Drag any data point toward an axis to see how the points group.
- Activate the Graph Trace tool and press ◀ or ▶ to move across points.

When you add a variable to either axis, the plot for that variable replaces the default caseplot. The default caseplot redisplay if you remove the plotted variable from each axis.

Using the Context Menu

The context menu provides access to the tools most commonly used with the selected object. The context menu displays different options depending on the active object and the task you are performing.

- ▶ To open the context menu for an object.

Windows®: Right-click the object.

Mac®: Hold ⌘ and click the object.

Handheld: Point to the object and press ctrl menu.

The context menu includes the **Color** option. You can use the Color option to change the data to the color of your choice.

Other options that are appropriate for various plots also appear on the context menu.

Selecting Data and Displaying Summary Information

When you hover over part of a plot, the Data & Statistics application displays summary information for the data it represents.

1. Hover at an area of interest in a plot to display data values or summary information. For example, you can hover over the center of a box plot to display the median summary data.
2. Click once to select a representation of data in a plot.

Data points are shown with a bold outline to indicate selection. You can click a point a second time to deselect it, or click additional points to add to the selection.

Plotting Variables

To plot variables, start with a problem that includes a Data & Statistics application and lists created in the Lists & Spreadsheet application or the Calculator application.

1. Click the Add Variable region near the center of an axis.

If no variable is plotted on the axis, the tooltip **Click or Enter to add variable** displays.

2. Click the tooltip **Click or Enter to add variable**.

A list displays the names of available variables.

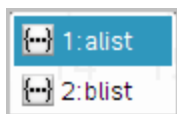

3. Click the name of the variable to plot.

Note: By convention, the independent variable is shown on the x-axis.

The default plot for one variable is a dot chart. The data points in the default caseplot reposition to represent the elements of the selected variable in a dot chart.

4. (Optional) Click the Add Variable region near the center of the remaining axis to plot a second variable.

The default plot for two variables is a scatter plot. The data points shift to represent the elements of both variables as a scatter plot.

5. (Optional) Repeat Steps 1-3 to choose additional variables to plot on the vertical axis.

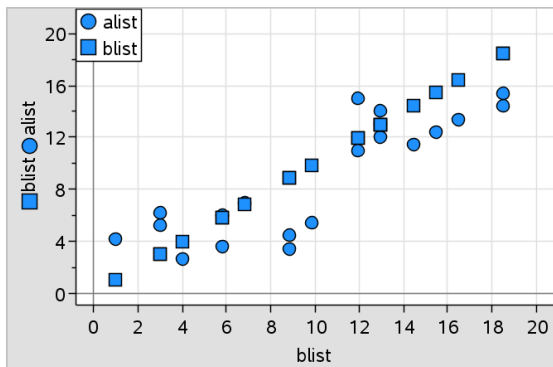

The name of each variable that you add is appended to the label on the axis. The default data point shape changes to help you distinguish data, and a legend is displayed to identify the shapes.

6. Change, analyze, or explore the plotted data.
 - Remove or change the variable on an axis by clicking the Add Variable region again.
 - View the plotted data in another supported plot type by selecting a tool from the **Plot Types** menu.
 - Choose the Graph Trace tool on the **Analyze** menu and press ◀ or ▶ to move across the data points in the plot.
 - The lists that you plot as variables can include incomplete or missing cases. (A case is the data contained in a row of cells in the Lists & Spreadsheet application.) The Lists & Spreadsheet application displays a void as an underscore (“_”), and Data & Statistics plots no data point for a void cell.

Manipulating Plotted Data

You can manipulate data points on the Data & Statistics work area to explore their effects. For example, you could explore how a specific group of values affects the median.

You can move a data point only in directions allowed by its definition. If a list is defined with a formula in Lists & Spreadsheet, the points in Data & Statistics may not move because of the formula’s restrictions. For example, you can manipulate a plot that represents the result of $y=x$, but you can only move along a line.

You cannot move points that represent data in a locked variable or data that represents a categorical value.

1. On the Data & Statistics work area, click a representation of data—such as a histogram bin or a whisker of a box plot—that is not locked or restricted by a formula.

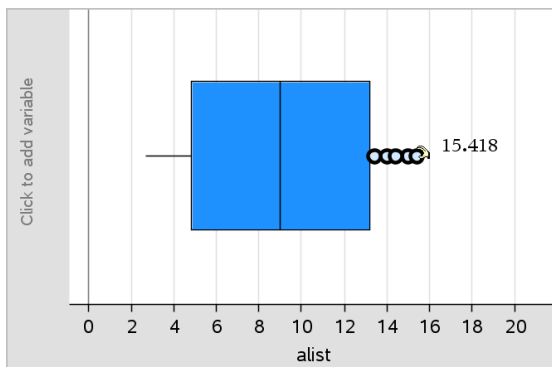

The pointer changes to an open hand to show that the data can be moved.

2. Drag the selection to explore how different values of the point affect the plot.

Handheld: Press **ctrl** to grab, and then swipe or use the arrow keys to drag.

As you drag, the changing value displays on the work area.

Overview of Raw and Summary Data

You can create plots directly from raw data or from a summary table.

	A person	B ht	C wt	D eyecolor	E gender	F
1	1	56	130	blue	f	
2	2	55	150	blue	m	
3	3	60	200	green	f	
4	4	62	270	brown	m	
5	5	65	250	brown	f	
6	6	71	187	green	m	
7	7	62	176	brown	m	

Raw data

	A color	B counts	C	D	E
1	blue	3.			
2	green	3.			
3	brown	4.			
4					
5					
6					
7					

Summary table for eye color based on raw data

- Raw data consists of a single list, such as a list of eye colors. When you create a plot of raw data, Data & Statistics counts the occurrences for you. Plotting raw data directly gives you flexibility in analyzing it.
- A summary table consists of two lists, such as eye colors (the X or Y List) and counts of eye-color occurrences (the Summary List). For more information, see *Using Lists & Spreadsheet* chapter.

Working with Numeric Plot Types

Plots can represent the data from a variable in a variety of ways. Choosing the appropriate plot can help you visualize the data. For example, you may be able to observe the shape and spread of the data in one plot type and another type may be useful for determining the best method for statistically evaluating data.

Creating Dot Plots

Dot plots, also known as dot-frequency plots, represent one-variable data. Dot plots are the default plot type for numeric data. When you plot a variable as a dot plot, one dot represents each value in the list. Each dot displays on the axis at a point that correspond to the value.

1. To create a dot plot, click the Add Variable region in the center of an axis and click the name of a numeric variable. For more information, see *Plotting Variables*.
2. (Optional) To split a dot plot by category, click the Add Variable region on the other axis and choose the list that contains the corresponding category data.
3. (Optional) To plot multiple dot plots, choose **Add X Variable** on the **Plot Properties** menu and click a numeric variable from the list that displays. A second dot plot appears on the work area and the name of the plotted variable is added to both axis labels.
4. Explore the plotted data.
 - Hover over a data point to display data values.
 - Drag a dot to move it. As you move a point, the values associated with it change on the work area display and in the list for the variable.
 - Activate the Graph Trace tool and press ◀ or ▶ to move across the data points in the plot in list order. Points enlarge and display a bold outline as you move across them in Trace mode.

Creating Box Plots

The Box Plot Tool plots one-variable data in a modified box plot. “Whiskers” extend from each end of the box, either to 1.5 times the interquartile range or to the end of the data, whichever comes first. Points that are a width of $1.5 \times \text{Interquartile Range}$ past the quartiles plot individually, beyond the whiskers. These points are the potential outliers. When no outliers exist, x-min and x-max are the prompt for the end of each whisker.

Box plots are useful for comparing two or more sets of data that use the same scale. If a dataset is large, a box plot can also be useful in exploring data distribution.

1. Click the Add Variable region in the center of an axis. The default plot for one numeric variable is a dot plot. For more information, see *Plotting Variables*.

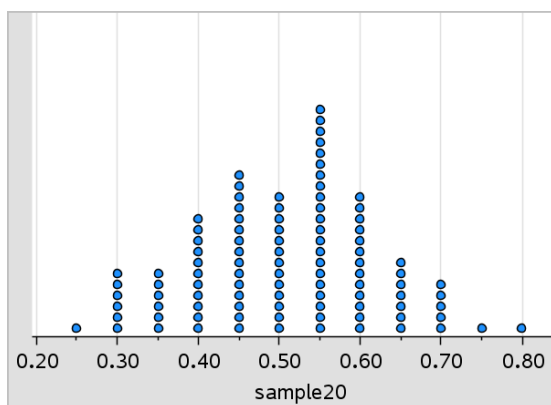

Note: If two variables are plotted in the work area, you can create a dot plot by removing one variable. Choose **Remove X Variable** or **Remove Y Variable** from the **Plot Types** menu.

2. On the **Plot Types** menu, click **Box Plot**.

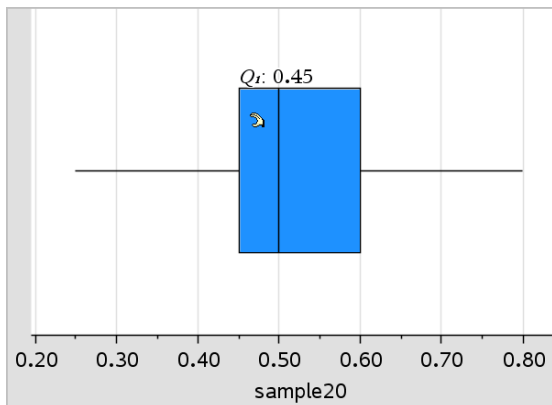

A modified box plot displays on the Data & Statistics work area.

Note: You can split a box plot by category by adding a list that contains corresponding categorical data to the y-axis.

- (Optional) To add additional variables for comparing box plots on the same axis, click **Add X Variable** on the **Plot Properties** menu.

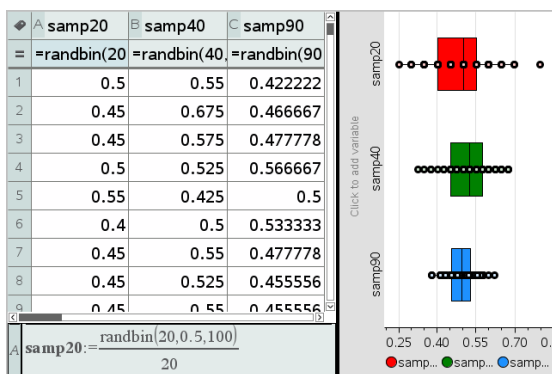

For example, you can use multiple box plots to compare the distributions of sample proportions. In the example, true proportion is .5 and sample size varies from $n=20$ to $n=40$ to $n=90$.

Notes:

- You can create a box plot with frequency by choosing **Add X Variable** or **Add Y Variable** on the **Plot Properties** menu.
- You can specify a variable multiple times as you choose variables to plot as box plots.

- The variable used to provide frequency information is added to the label on the horizontal axis in the format: $x_variablename$ {*frequencylist_name*}.
4. Point and click the regions of the box plot to explore and analyze the data it represents.
- Hover over a region or over a whisker to display the details for the portion of the plot that interests you. The label for the quartile that corresponds to your selection is displayed.
 - Click a region of the box plot to select the data points or whiskers. Click again to remove the selection.
 - You can select any box plot that does not include frequency data and choose **Dot Plot** on the context menu to change the plot type.
 - Drag a selection to move it and explore other possibilities for the data.
 - Use the arrow keys to move a data point one pixel at a time.
 - Activate the Graph Trace tool and press ◀ or ▶ to move across dots and regions of the plot. As the trace cursor moves, the values for Q1, the median, Q3, and whisker ends/outliers are displayed.
5. Change the plot from a modified box plot to a standard box plot by choosing **Extend Box Plot Whiskers** on the **Plot Properties** menu.

The box plot is redrawn as a standard box plot with extended whiskers.

The standard box plot's whiskers use the minimum and maximum points in the variable and outliers are not identified. The whiskers on the plot extend from the minimum data point in the set (x -min) to the first quartile (Q1) and from the third quartile (Q3) to the maximum point (x -max). The box is defined by Q1, Med (median), and Q3.

Note: You can click **Show Box Plot Outliers** on the **Plot Properties** menu to return to the modified box plot.

Plotting Histograms

A histogram plots one-variable data and depicts the distribution of data. The number of bins displayed depends on the number of data points and the distribution of these points. A value that occurs on the edge of a bin is counted in the bin to the right.

Creating a Histogram from Raw Data

1. Create the list that you want to plot as a histogram. For example, you can enter or collect data as a named list on a Lists & Spreadsheet page.

	A	B	C	D	E	F	G
=							
1	40						
2	40						
3	45						
4	45						
5	45						
6	45						
7	55						
8	55						
9	55						
10	55						

2. On a Data & Statistics page, click the x or y axis, and select your list as the data to plot.
3. From the **Plot Types** menu, click **Histogram**.

The data forms the bins of a histogram, with Frequency plotted by default on the unselected axis.

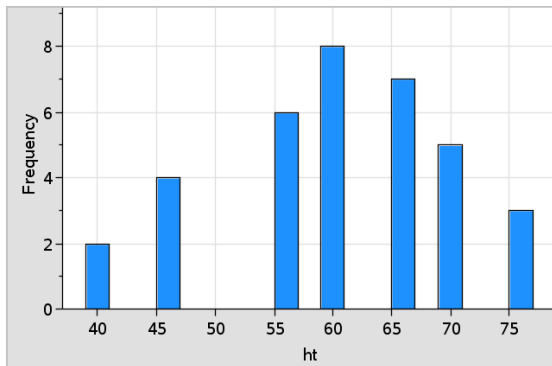

4. Explore the data.
 - Hover over a bin to see the information for that bin.
 - Click a bin to select it. Click the bin again to deselect it.
 - Drag the side of a bin to adjust bin width and number of bins.

Note: The bins are not adjustable in categorical plots or plots in which you choose variable bin widths.

- On the **Analyze** menu, click **Graph Trace** and press ◀ or ▶ to cycle through the bins and display their values.

Adjusting the Histogram Scale of Raw Data

1. On the **Plot Properties** menu, click **Histogram Properties** and choose **Histogram Scale**.
2. Choose the format for the scale of the histogram.
 - **Frequency** - displays data based upon the number of values that occur within each bin. This is the default data representation.
 - **Percent** - displays data in the histogram by each group's percent value of the whole data set.
 - **Density** - displays data based upon the density of each group within the data set.

Creating a Histogram with Frequency or Summary Data

1. On a Lists & Spreadsheet page, create two lists: one containing the “bins,” such as heights in a population (*ht*), and the other containing the frequencies of those heights (*freq*).

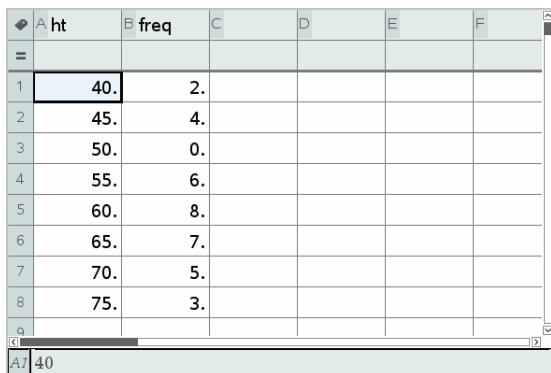

The screenshot shows a TI-84 Plus calculator's Lists & Spreadsheet page. The screen displays a table with two columns: 'ht' and 'freq'. The data is as follows:

	A ht	B freq	C	D	E	F
=						
1	40.	2.				
2	45.	4.				
3	50.	0.				
4	55.	6.				
5	60.	8.				
6	65.	7.				
7	70.	5.				
8	75.	3.				
9						
0						
10						
11						
12						
13						
14						
15						
16						
17						
18						
19						
20						
21						
22						
23						
24						
25						
26						
27						
28						
29						
30						
31						
32						
33						
34						
35						
36						
37						
38						
39						
40						

2. On a Data & Statistics page, access the context menu on the x axis, and click **Add X Variable with Summary List**.
3. Select *ht* as the X List and *freq* as the Summary List.

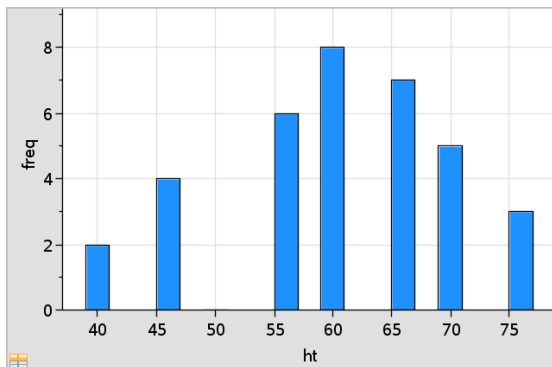

Note: It is up to you to set the data and bins in a meaningful way when using summary data.

Setting Equal Bin Widths

By default, bin widths are set to equal. You can specify the width and alignment of equal-width bins.

1. On the **Plot Properties** menu, click **Histogram Properties > Bin Settings**, and choose **Equal Bin Width**.

The **Equal Bin Width Settings** dialog box opens.

2. Type values to set **Width** and **Alignment** of the bins.
3. Click **OK** to apply the changes and redraw the bins.

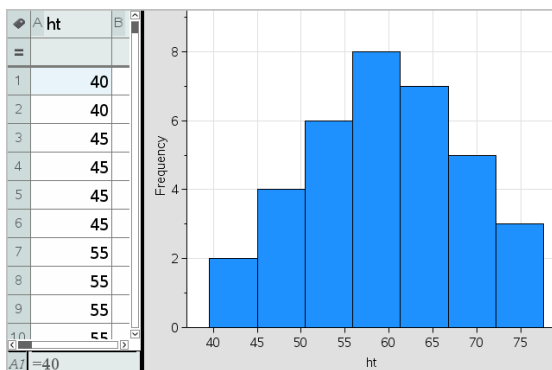

Both the data represented by the bins and the value you type for the alignment affect the placement of bins on the scale.

Setting Variable Bin Widths

You can set variable bin widths based on a list of bin boundaries.

1. Create a named list containing boundary values.

For example, a boundary list defined as {60,70,100,110} will create bins at 60 to 70, 70 to 100, and 100 to 110.

Note: The data must fall within the specified bin widths. For example, a data point of 115 would be outside the bins in the above list, and you would receive a Data/Bin Location Mismatch error.

2. On the **Plot Properties** menu, click **Histogram Properties > Bin Settings**, and choose **Variable Bin Width**.

The **Variable Bin Width Settings** dialog box opens.

3. Select your boundary list as the **List of Bin Boundaries**.
4. Click **OK** to apply the changes and redraw the bins.

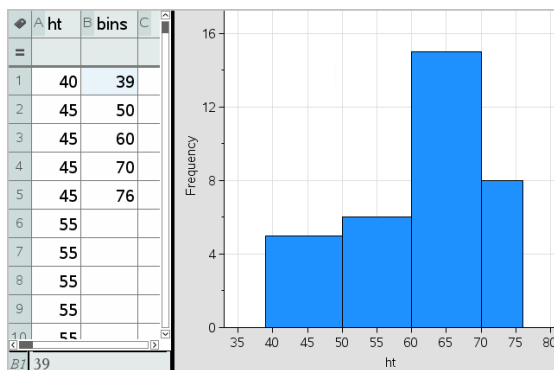

Note: You cannot change variable bin widths by dragging their boundaries; you must edit the list of boundaries or restore equal-width bins.

Creating a Normal Probability Plot

A normal probability plot shows one set of data against the corresponding quartile (z) of the standard normal distribution. You can use normal probability plots to judge the appropriateness of the normal model for your data.

1. Choose or create the data you want to use for a normal probability plot. Use a named list from Lists & Spreadsheet or Calculator.

2. Plot the data in one of the following ways:
 - Create a dot plot by selecting a column and choosing **Quick Graph**.
 - Add a Data & Statistics work area. Click the Add Variable region on an axis and click the data list name to plot the variable.
3. On the **Plot Types** menu, click **Normal Probability Plot**.

The data graphs in the Data & Statistics work area. You can examine the graph to compare the normal variable against the quartile.
4. Explore the data represented in the normal probability plot.
 - Hover over a data point to display its value.
 - Click to select a data point. Click again to deselect it.
 - Click multiple data points to select them.
 - Activate the Graph Trace tool and press ◀ or ▶ to move across the data points and display values.

Creating a Scatter Plot

A scatter plot shows the relationship between two sets of data. You can also plot a scatter plot by using the Quick Graph tool in the Lists & Spreadsheet application.

1. In the Data & Statistics work area, click the Add Variable region and select the variable that contains the data you want to see represented on an axis.

The plot of the selected variable displays on the axis.
2. Click the Add Variable region of the other axis and select the variable containing the data you want to plot.

The data points shift to represent the data in the selected variable.

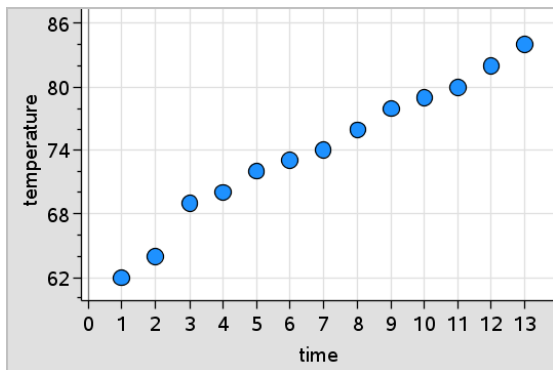

3. Analyze and explore the data in the plot.
 - Click a point to select it.
 - Hover over a data point to view the summary data.
 - Work with the data using the available tools on the **Analyze** menu. For example, choose the Graph Trace tool and press ◀ or ▶ to move across the plot.
4. Optional: To plot additional lists against the x-axis, right-click the y-axis and click **Add Variable**.

Creating an X-Y Line Plot

An X-Y line plot is a scatter plot in which the data points are plotted and connected in order of appearance in the two variables. Like scatter plots, these plots depict the relationship between two sets of data.

By convention, the left-most column of data is represented on the horizontal axis.

1. Create a scatter plot. For more information, see *Creating a Scatter Plot*.
2. On the **Plot Types** menu, click the **XY Line Plot** tool.

The data points within each set are connected to each other by a line.

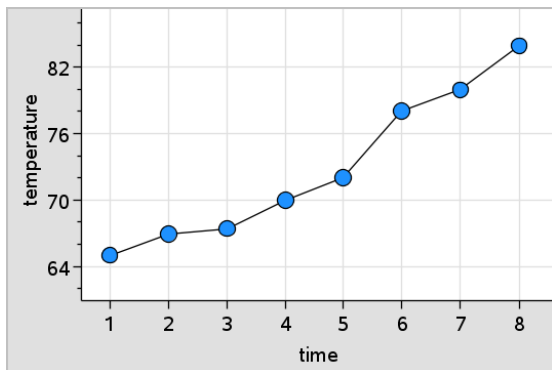

Note: The dots are connected in the order that they appear in the list variable on the horizontal axis. To change the order, use the sort tool in Lists & Spreadsheet.

- Analyze and explore the data in the plot.
 - Hover over a data point to view the summary data.
 - Work with the data using the available tools on the **Analyze** menu. For example, choose the Graph Trace tool and press the arrow keys to move across the dots in the plot and view the values.

Working with Categorical Plot Types

You can sort and group data using the categorical plot types:

- Dot Chart
- Bar Chart
- Pie Chart

The categorical plot types can be used to compare the representations of data across different plots. When the same variable (list) is used for a dot chart and a bar chart or pie chart in a problem, selecting a data point or segment in one of the plots selects the corresponding data point, segment, or bar in all other plots that include the variable.

Creating a Dot Chart

The default plot type for categorical data is the dot chart.

When one variable is plotted, the value of each cell is represented as one dot, and the dots are stacked at the point on the axis that corresponds to the cell value.

1. In Lists & Spreadsheet, create a spreadsheet that includes at least one column of string values that can be used as categories for data.

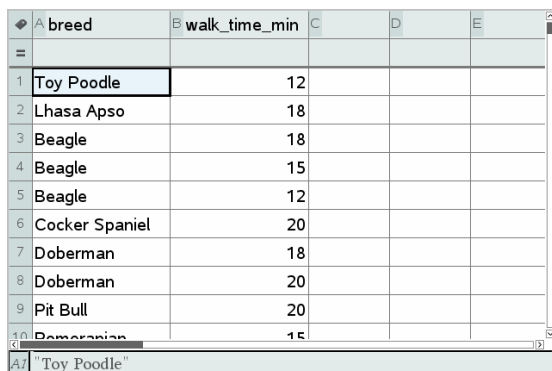

	A breed	B walk_time_min	C	D	E
1	Toy Poodle	12			
2	Lhasa Apso	18			
3	Beagle	18			
4	Beagle	15			
5	Beagle	12			
6	Cocker Spaniel	20			
7	Doberman	18			
8	Doberman	20			
9	Pit Bull	20			
10	Germanian	15			

Note: To type a string in Lists & Spreadsheet, enclose the characters in quotes.

2. Add a Data & Statistics page to the problem.

Notes:

- You can also use the Lists & Spreadsheet Quick Graph tool to automatically add a Data & Statistics page and plot the selected column.
 - The new Data & Statistics work area displays a default caseplot with a caption, variable name, and unplotted data points for the variable. You can click the variable name in the caption to choose another variable for previewing, or drag a default data point toward an axis to plot the current variable.
3. Move near the center of either axis and click the Add List region. The list of variables displays.

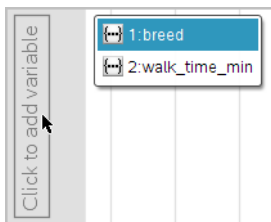

- Click the list that contains the categories you want to use for sorting data.

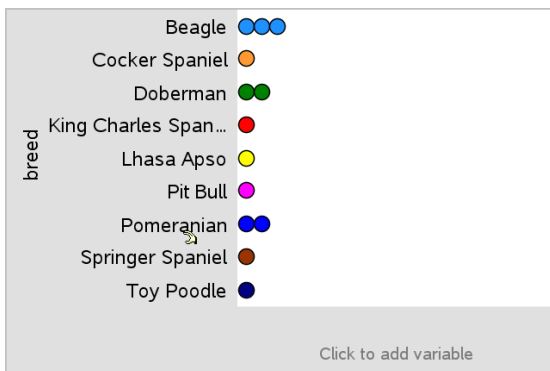

A dot chart plots in the work area. The application labels the axis with the variable name and shows a dot for each instance of a category.

- Explore the plotted data.
 - Hover over a dot in the plot to display data values.
 - Click a dot to select it. Click the dot a second time to deselect it or remove it from a selection of multiple dots.
 - Activate the Graph Trace tool and press ◀ or ▶ to move across the points in list order. Dots display a bold outline as you move across them in Trace mode.

Creating a Bar Chart

Like dot charts, bar charts display categorical data. The length of a bar represents the number of cases in the category.

- Click the Add Variable region of either axis and choose the name of a categorical variable. For more information, see *Creating a Dot Chart*.
- On the **Plot Types** menu, click **Bar Chart**.

The dot chart changes to a bar representation of the data.

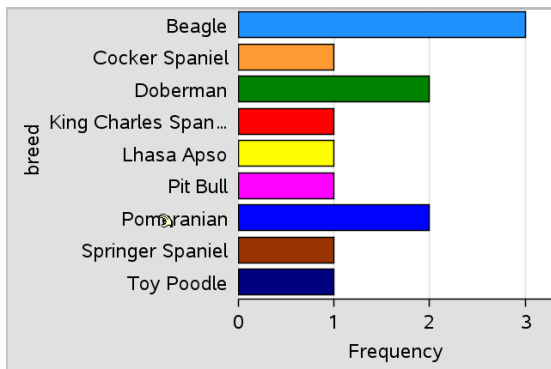

3. Explore the data in the plot.

- Hover over a bar to see a category summary (the number of cases and percentage among all categories).
- Activate the Graph Trace tool and press ◀ or ▶ move across the bars and view summary information.

Creating a Bar Chart from a Frequency Table or Summary Data

1. On a new Data & Statistics page, create a bar chart with frequency or summary data by choosing **Add X Variable** on the **Plot Properties** menu.

Note: You can also create a bar chart with frequency by selecting **Add Variable with Summary List** from the context menu of the Add Variable region of an axis.

2. Select the desired variable from the pop-up choices.
3. Set the height of the bars with the summary variable by selecting **Add Summary List** from the **Plot Properties** menu.
4. Select the summary list from the pop-up choices.

The bar chart plots on the work area. The icon in the lower left corner indicates that this plot was generated from summary data.

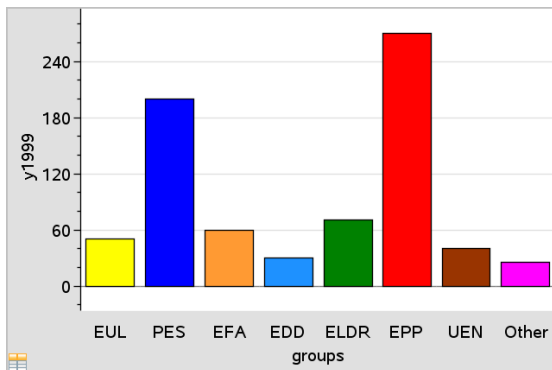

5. Hover over a bar to see a category summary, or use the Graph Trace tool on the **Analyze** menu to move across all of the bars displaying the summaries.
6. (Optional) Add summary lists to create a comparative bar chart.

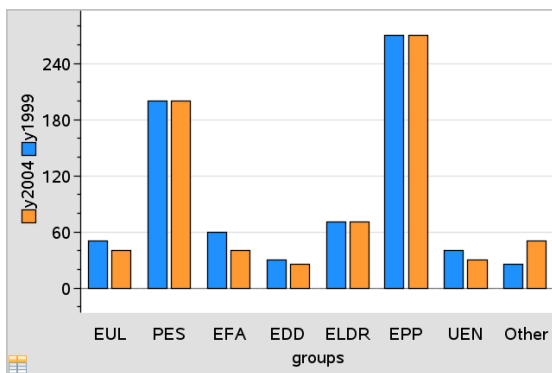

Creating a Pie Chart

A pie chart represents categorical data in a circular layout and uses an appropriately proportioned segment for each category.

1. Create a dot chart on the work area.
2. On the **Plot Types** menu, click **Pie Chart**.

The dots move by category into the segments of the pie chart.

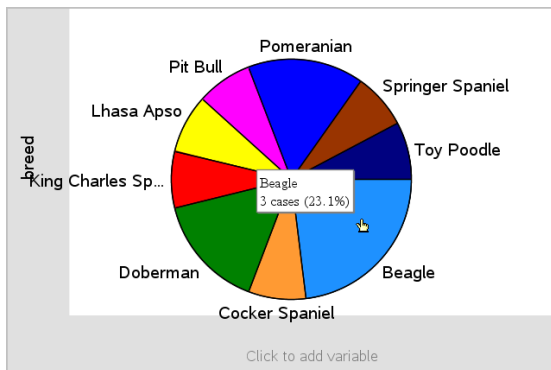

3. Hover over a segment to see the summary for the category, or use the Graph Trace tool on the **Analyze** menu to move across each segment displaying all of the summaries. The summary shows the number of cases for the category and the percentage among all cases.

Note: You can switch to a pie chart from a bar chart generated from summary data.

Creating a Comparative Bar Chart

This might be used to explore data in a two-way table.

1. Type the raw data on a Lists & Spreadsheet page.

A	person	B	ht	C	wt	D	eyecolor	E	gender	F
1		1	56	130	blue	f				
2		2	55	150	blue	m				
3		3	60	200	green	f				
4		4	62	270	brown	m				
5		5	65	250	brown	f				
6		6	71	187	green	m				
7		7	62	176	brown	m				

2. From the **Insert** menu in the toolbar, click **Data & Statistics**.

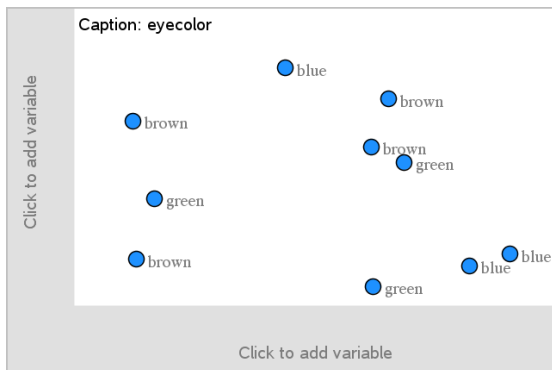

Note: Your screen may differ, depending on the data you entered.

3. Select the **Click to add variable** field, and select **eyecolor** as the variable for the x axis.
4. On the **Plot Type** menu, click **Bar Chart**.

The frequency of the eyecolor data is plotted.

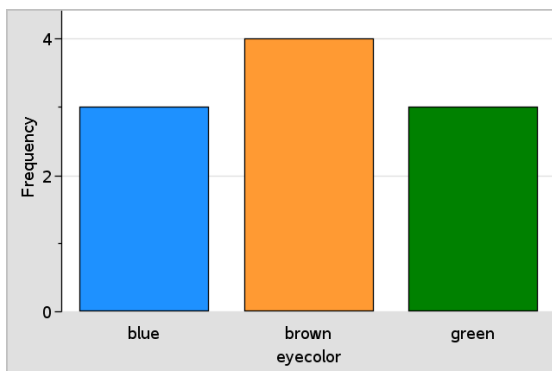

5. To split the eyecolor data by gender, click the **Plot Properties** menu, click **Split Categories by Variable**, and then click **gender**.

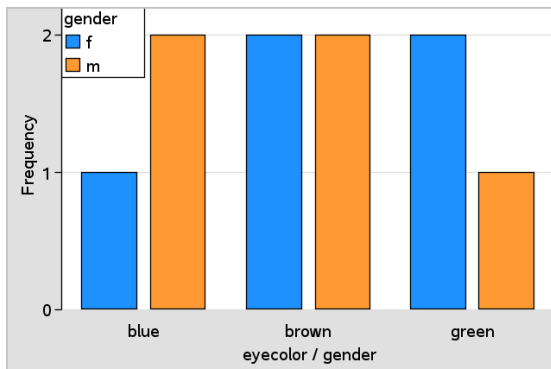

Splitting a Numeric Plot by Categories

You can use a categorical split to sort the values plotted on an axis.

1. Open a problem that includes a Lists & Spreadsheet page, or create data to be plotted in the Lists & Spreadsheet application.

In this example, lists contain dog breed and daily walk information.

A	B	C	D	E
breed	walk_time_min			
1 Toy Poodle	12			
2 Lhasa Apso	18			
3 Beagle	18			
4 Beagle	15			
5 Beagle	12			
6 Cocker Spaniel	20			
7 Doberman	18			
8 Doberman	20			
9 Pit Bull	20			
10 Doberman	15			

2. Click column letter (B).
3. On the Lists & Spreadsheet **Data** menu, click the **Quick Graph** tool.

The Quick Graph tool adds a Data & Statistics page. Data & Statistics plots the variable and labels the horizontal axis.

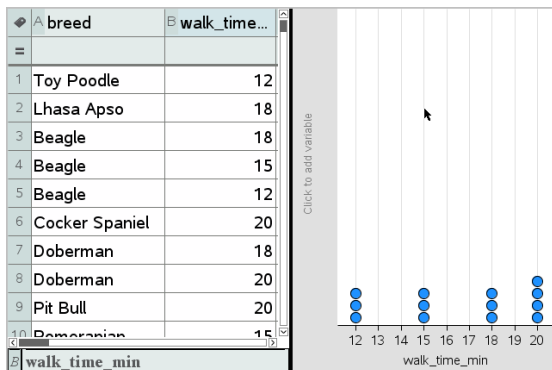

- To plot the numeric data for each category, hover on the Add Variable region near the center of the vertical axis and click the tooltip **Click or Enter to add variable**.

The list of available variables displays.

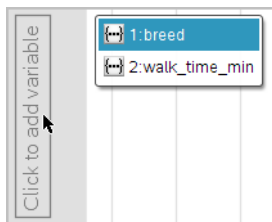

- On the list of variables, click the name of the category variable.

Data & Statistics labels the vertical axis and plots the numeric data for each category.

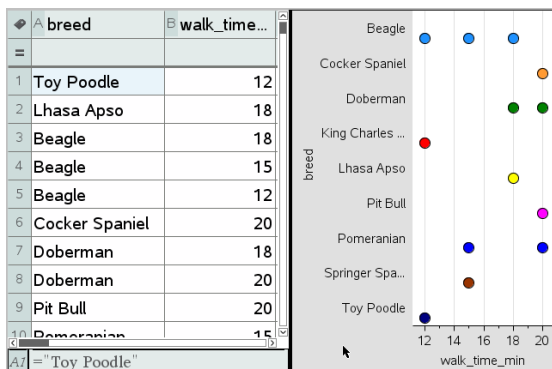

Exploring Data

You can manipulate and explore plotted data.

Moving Points or Bins of Data

1. Click and hold the desired point or bin.
The pointer changes to an open hand .
2. Drag the point or bar to the new location and release it. Moving the point changes the values for x and y.

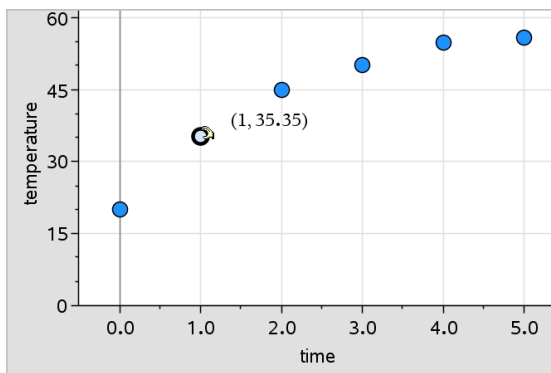

If you are working with data from Lists & Spreadsheet, the data that corresponds to the original point or bar automatically updates in the original column(s) in Lists & Spreadsheet as you move the point.

You can also move points or bins by changing the numbers in the Lists & Spreadsheet or Calculator applications. Data will update in all of the representations.

Moving Multiple Points

1. Position the pointer over each data point that you want to select. When the pointer changes to an open hand , click to add the point to the selection.

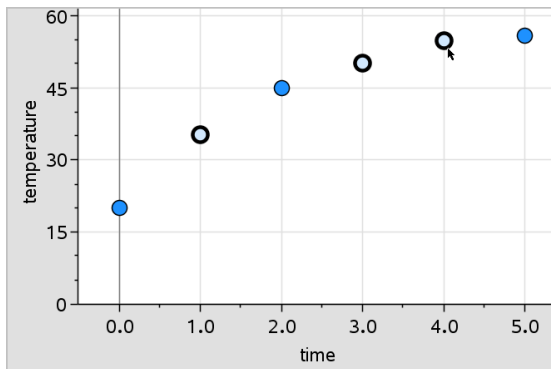

Alternatively, you can drag a selection rectangle around the points to select them.

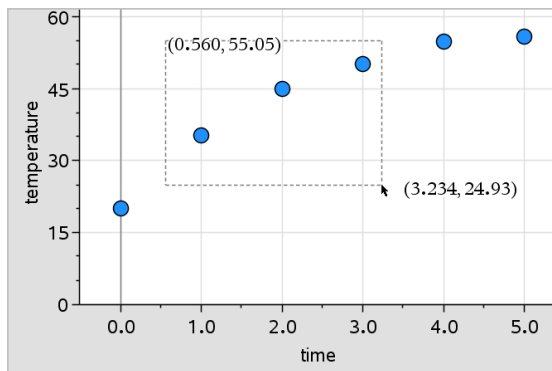

2. Drag any of the selected points to move them all.

Note: When a list is defined in Lists & Spreadsheet as a formula, the movement of points is restricted to positions that satisfy the formula.

Sorting Plotted Categories

You can sort plotted categories in list order, value order, or alphabetically by category name.

1. Click the work area that contains the plotted data.
2. On the Actions menu, click Sort, and then click the type of sort.

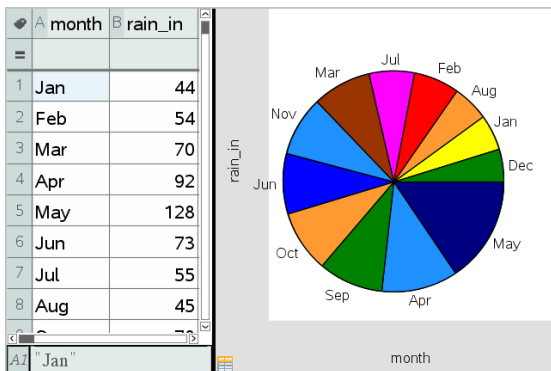

Months listed chronologically but sorted by value (amount of rainfall)

Note: You can customize the order of the categories by clicking a label and dragging it.

Plotting a Value

You can plot a value on an existing plot. It displays as a vertical line in the work area.

1. From the **Analyze** menu, click **Plot Value**.

A text box with a default expression opens in the work area.

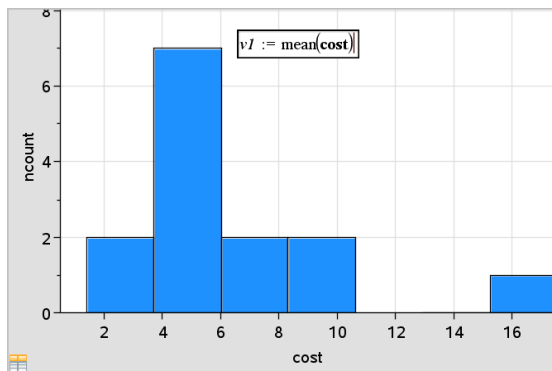

2. Type the value you want to plot, and press **Enter**. In this example, the value is `v1:= mean(cost)`.

The line is drawn at that value, perpendicular to the axis. If you have multiple plots on the work area, a plot value segment displays for each plot.

Note: If you use a frequency table to generate a histogram, reference the frequency list in your expression. For example, type the expression "v1:= mean(List, FreqList)" in the plot value entry box.

3. Click the line to display the value.

Note: Double-click the value to edit the expression.

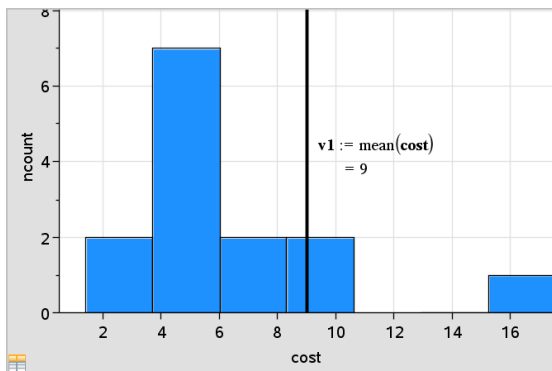

Plot value with value displayed

You can use Plot value for a single number or any expression that evaluates to a number. If the value is dependent on the data, like **mean**, when you drag a point or make changes in the Lists & Spreadsheet application, the line updates to reflect the change, allowing for investigation of the influence of points on the calculation.

Removing a Plotted Value

1. Select the plotted value line.
2. From the **Actions** menu, click **Remove Plotted Value**.

Changing the Plot Type

You can change the plot type, to view different representations of data.

- ▶ On the **Plot Type** menu, click a new plot type. Only the supported plot types are available. For example, only univariate plot types are available when a single variable plotted on an axis.

The data representation changes to the new plot format.

Note: Options are unavailable on the menu if the plotted data cannot be represented by the plot type. For example, if a scatter plot is displayed in

the work area, you cannot create a box plot without first removing the variable from the y-axis.

Rescaling a Graph

You can change the scale of the axes by using Translation and Dilation. The pointer changes to indicate whether Translation (+) or Dilation (≠) is available in zones on the axes.

Translation

A translation slides a set of axes a fixed distance in a given direction. The original axes have the same shape and size.

1. Position the pointer over a tic mark or label in the middle third of the axis. The pointer changes to +.

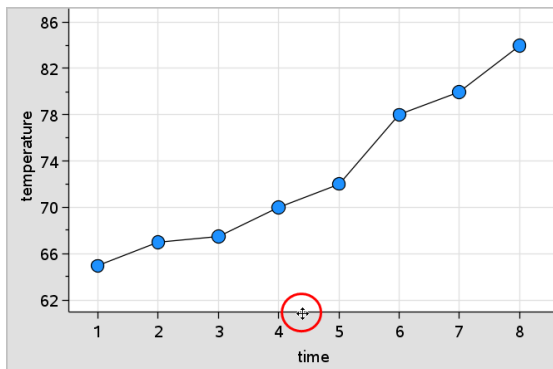

2. Click to grab. The pointer changes to a grasping hand . Drag to the desired position and release.

Dilation

Dilation retains the shape of the axes, but enlarges or reduces the size.

1. Position the pointer over a tic mark or label near the ends of the axis. The pointer changes to ≠ on the vertical axis or ≠ on the horizontal axis.

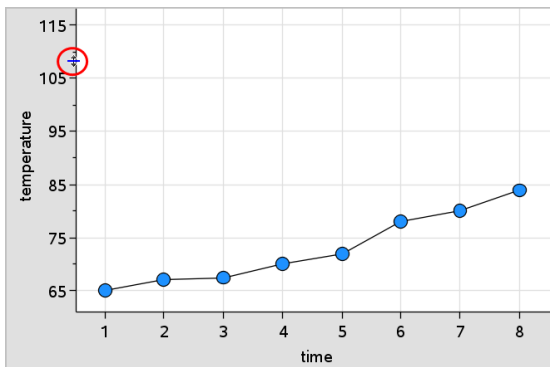

- Click to grab. The pointer changes to an open hand . Drag to the desired position and release.

Adding a Movable Line

You can add a movable line to a plot. Moving and rotating the line on the work area changes the function that describes it.

- From the **Analyze** menu, click **Add Movable Line**.

The movable line displays and is labeled with a function that describes it. For this example, Data & Statistics stores the expression for the movable line in the variable $m1$.

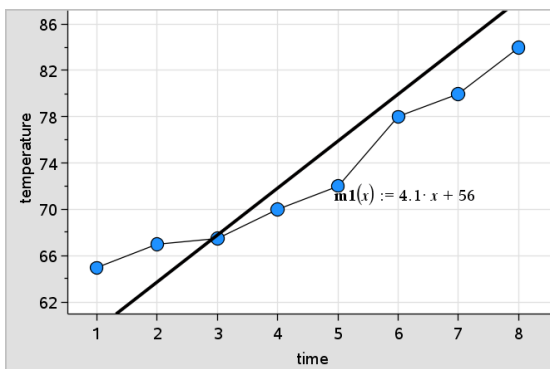

Rotating a Movable Line

- Click and grab either end of the line.
The pointer changes to .

2. Drag to rotate and change the slope of the line.

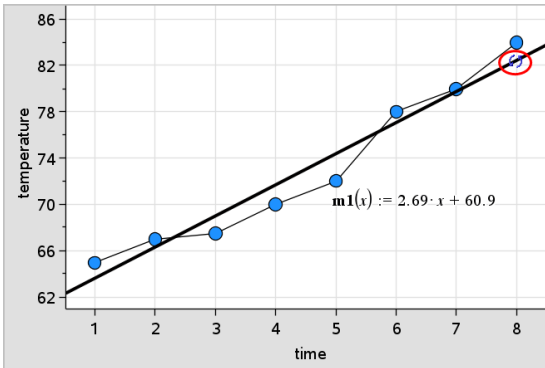

The function $m1(x)$ is updated for the changes in the position of the movable line.

Changing the Intercept

1. Click in the middle of the movable line.

The pointer changes to \oplus .

2. Drag to change the intercept.

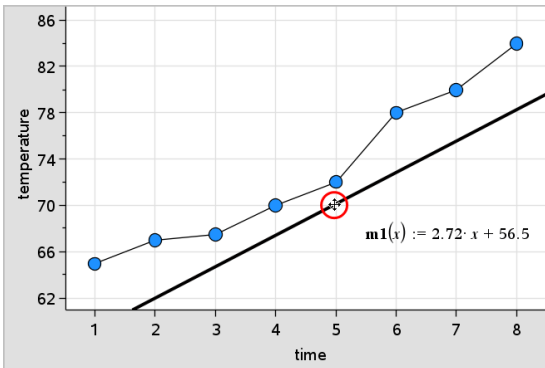

The number at the end of the equation changes to show the change in the intercept.

Note: The movable line is stored as a function that can be used for prediction in the Calculator application.

Locking the Intercept at Zero

You can lock the intercept of the movable line at zero.

- ▶ From the **Analyze** menu, click **Lock Intercept at Zero**.

You can unlock the intercept by choosing **Unlock Movable Line Intercept** on the **Analyze** menu.

Tracing a Movable Line

You can trace a movable line to predict and analyze values.

1. Click the line.

The pointer changes.

2. From the **Analyze** menu, click **Graph Trace** to enable Trace mode for the line. Rotation of the line is not supported in Trace mode.

3. Press ◀ or ▶ (left or right arrow keys) to trace the movable line.

If the plotted variables change, points on the graph and the line are updated automatically.

Showing a Line of Regression

You can show a line of regression when you have a scatter plot or an X-Y line plot on the work area. Studying the line of regression can help you understand the relationship between two variables.

1. With a scatter plot or X-Y line plot of two variables on the work area, click the **Analyze** menu, choose **Regression** and view the list of regressions.
2. Click the type of regression line to show. For example, choose **Show Linear ($mx+b$)** to plot a linear regression line as shown in the following example.

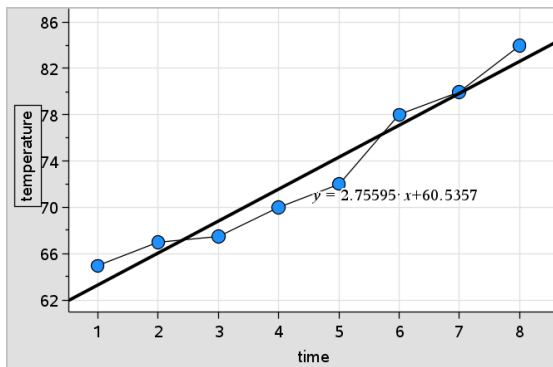

When the line of regression is selected, the expression for the line displays.

Showing Residual Squares

You can display residual squares on a plot. Residual squares can help you assess the appropriateness of the model for your data.

Note: This tool is only available when a regression or movable line is present in the work area.

- From the **Analyze** menu, click **Residuals** > **Show Residual Squares**.

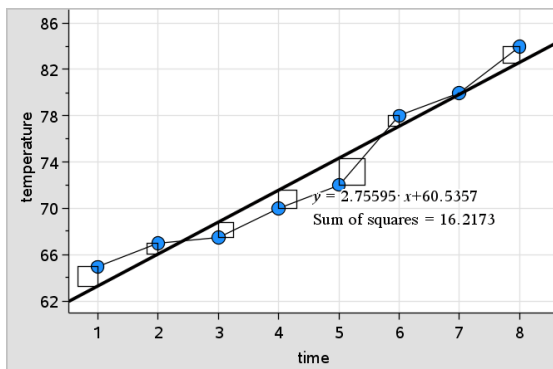

The sum of squares is updated as the line or data changes.

Showing a Residual Plot

You can show a residual plot to determine how well a line fits data. The work area must include a scatter plot and one or more movable lines, regressions, or plotted functions for **Show Residual Plot** to be available.

- ▶ With a scatter plot, line of regression, and/or movable line in the work area, click the **Analyze** menu, and click **Show Residual Plot > Residuals**.

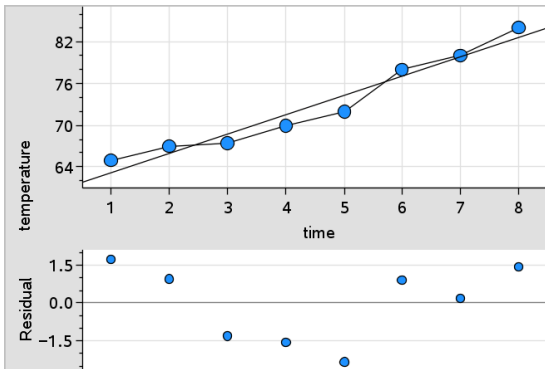

Notes:

- With multiple regressions or functions and movable lines plotted, you can select each by clicking the line to show its residual plot.
- Click and hold a dot on the residual plot to see the residual.
- The residual plot for the selected regression or function displays in the work area.
- For consistency in comparing sets of data, residual plots do not rescale when you move from one function or regression to another.
- Select a function or regression before a showing residual plot. If no function or regression is selected and there are several plotted, Data & Statistics arbitrarily selects the function or regression for showing the residual plot.
- Axes can be adjusted by clicking and dragging.

Removing a Residual Plot

- ▶ With a scatter plot, line of regression, and/or movable line in the work area, click the **Analyze** menu, and click **Hide Residual Plot**.

Using Window/Zoom Tools

Use the Window/Zoom tools to redefine the graph to better view points of interest. The Window/Zoom tools include:

- **Window Settings:** displays a Window Settings dialog box that lets you type the x-min, x-max, y-min, and y-max values for the axes.
- **Zoom - Data:** adjusts the zoom factor to display all plotted data.
- **Zoom - In:** lets you define the center point of the zoom in location. The Zoom In factor is approximately 2.
- **Zoom - Out:** lets you define the center point of the zoom out location. The Zoom Out factor is approximately 2.

Using the Window Settings Tool

1. On the **Window/Zoom** menu, click **Window Settings**.

The **Window Settings** dialog box opens. The current values for x-min, x-max, y-min, and y-max are displayed in the fields.

Note: Only the appropriate boxes are editable, depending on whether there are one or two axes in the work area.

2. Type the new values over the old values.
3. Click **OK** to apply the changes and redraw the plot.

Using the Zoom Data Tool

- ▶ On the **Window/Zoom** menu, click **Zoom Data**.

The work area rescales to display all plotted data.

Using the Zoom In Tool

1. On the **Window/Zoom** menu, click **Zoom In**.
2. In the work area, click the center point of the area of interest. This will be the center of the zoom in action.

The plot redraws to focus and enlarge the portion of the plot centered about the point you selected in the previous step.

Using the Zoom Out Tool

1. On the **Window/Zoom** menu, click **Zoom Out**.
2. In the work area, click the center point of the area of interest. This will be the center of the zoom out action.

The plot redraws to display a larger portion of the plot, centered about the point you selected in the previous step.

Graphing Functions

You can graph functions by typing them in Data & Statistics, or you can graph functions defined in other applications.

Graphing Functions Using the Plot Function Tool

You can use the Plot Function tool to plot functions in a work area that already includes a plot on the axes. Plot Function lets you specify and graph a function for comparison to an existing plot.

To use the Plot Function tool:

1. Create or open a problem that includes variables (from Lists & Spreadsheet) that are plotted on a Data & Statistics work area. Ensure that your work area contains both a horizontal axis and a vertical axis scale.
2. From the **Analyze** menu, click **Plot Function**.

A function entry field displays in the work area.

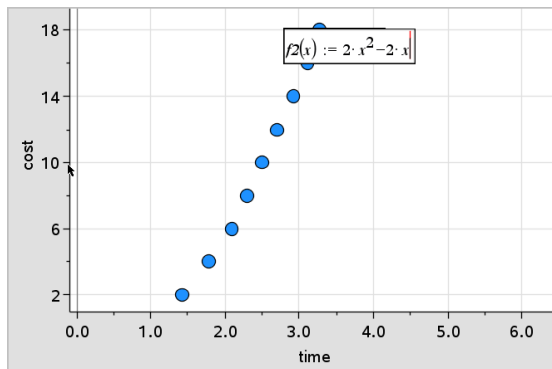

Note: You can edit the function's expression typed in the entry field. However, the function graphed in Data & Statistics cannot be manipulated or moved around the work area. To do that, use Graphs & Geometry.

3. Type the function in the entry field, and press **Enter**.

Note: You can rename the function by typing over $f_1(x)$: with another name, if you choose.

The function graphs in the work area and is saved as a variable for use in other applications.

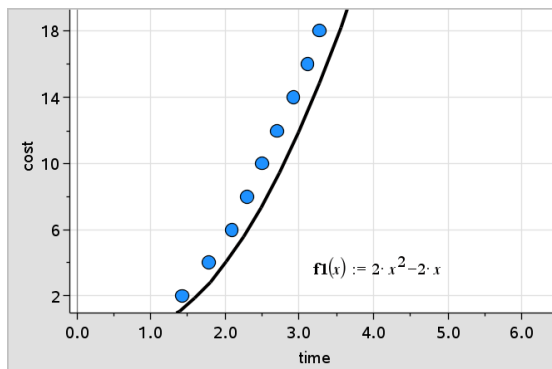

Entering Functions from Other Applications

You can enter a function that has been defined as a variable in another application, such as Lists & Spreadsheet, Graphs & Geometry, or Calculator.

1. Add a variable to each axis. You can access any variables defined in a Lists & Spreadsheet or Calculator application in your problem from the variable list.
2. From the **Analyze** menu, click **Plot Function**.

A function entry field displays in the work area.

$$f1(x) :=$$

3. Click  on the toolbar.

Handheld: Press .

A list of variables available in the problem displays.

4. Click to select the variable containing the function you want to plot.

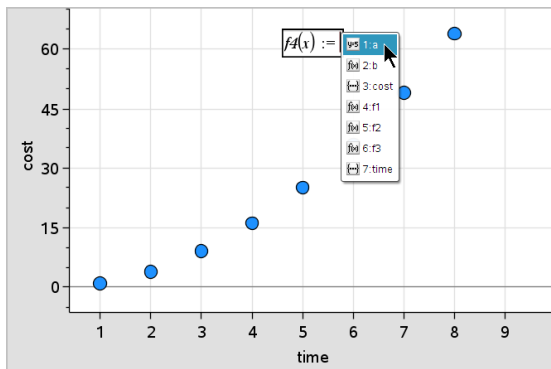

In the example below, the variable a contains the function $f(x)=x^2$.

5. Press **Enter**.

The function plots in the work area.

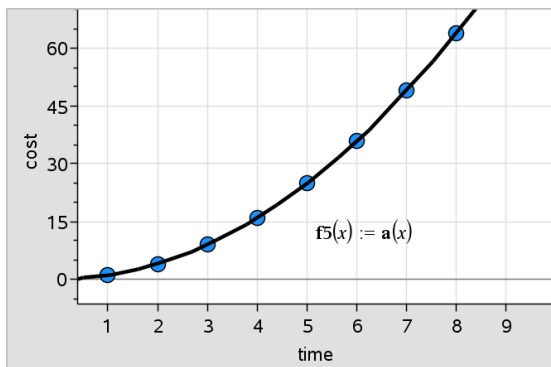

Editing a Function

You can edit a function and update it in the work area.

1. You can edit a function by double-clicking the equation and then making changes as required.
2. Press **Enter** after making all changes and the updates are displayed in the work area.

Using Data & Statistics Functions in other Applications

Data & Statistics functions are stored as variables, and may be used in other applications, in the same manner as any other variable. Support for all function types is included.

Note: Function numbers increment to use the next available. If you have defined $f_1(x)$ and $f_2(x)$ in Graphs & Geometry, the first function you create in Data & Statistics will be $f_3(x)$.

Using Show Normal PDF

You can approximate data plotted in the Data & Statistics work area against the normal probability density function. The tool overlays the normal probability density function using the mean and the standard deviation of the data in the histogram.

To show the normal probability density function for plotted data:

1. Add a variable to the x-axis.
2. On the **Plot Types** menu, click **Histogram**.

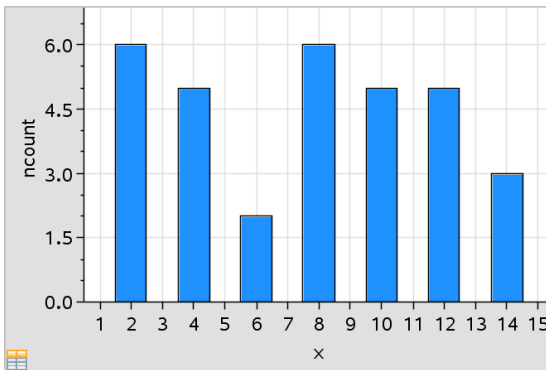

Note: Show Normal PDF is available only when histogram is the plot type.

3. From the **Analyze** menu, click **Show Normal PDF**.

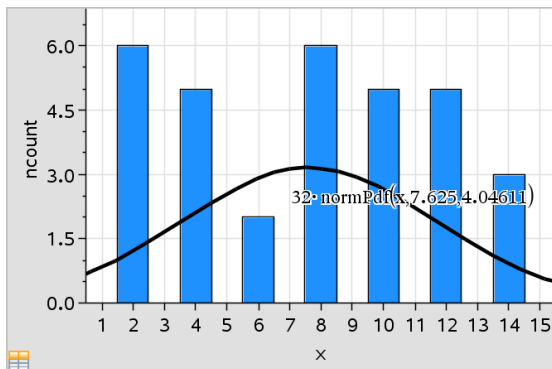

The normal PDF for the graph plots in the work area. The expression used to calculate the PDF displays when selected.

You can click **Hide Normal PDF** on the **Analyze** menu to remove the PDF.

Using Shade Under Function

Use **Shade Under Function** to find the area of a selected region under a function graphed in the work area.

1. Select any function graphed in the Data & Statistics work area. For example, select a previously graphed normal PDF.
2. From the **Analyze** menu, click **Shade Under Function**.

The pointer becomes a dotted vertical line and the boundary $\pm \infty$ displays when you position the mouse near the boundary on the left or right. You can click when ∞ displays to set it as a boundary.

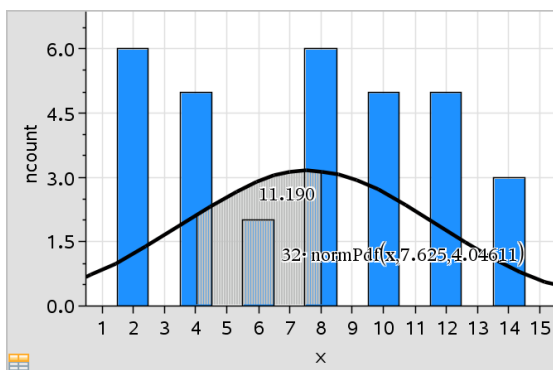

3. Select a point on the curve and click to indicate where to start shading under the function. The direction in which you move next determines whether the region shaded is on the left, right, or center of the curve.
4. Select a point on the curve and click to indicate the end boundary of the shaded area. A region under the function is shaded based on the points you selected.

You can work with Shade Under Function in the following ways:

- Select the region to display the values for data points in the shaded area.
- To remove the shading, right-click or **Ctrl**-click the shaded region and choose **Remove Shaded Region**.
- To change the fill color of the shaded area, right-click or **Ctrl**-click the shaded region, choose **Color**, choose **Fill**, and click a color.
- Use plot value to set the boundary to an exact number. When a boundary for shading is set to a plotted value, you can change the plotted value to update the shading.
- Edit a shaded region by clicking and dragging the edge at the starting or ending boundary.

Using Graph Trace

Graph Trace lets you move from one point on a graph to another to analyze variations in the data. You can use Graph Trace mode to explore the data for the following graphs.

- Graphs from Plot Function and Show Normal PDF
- Distribution curves (created in the Lists & Spreadsheet application)
- Movable Lines
- Regressions
- Caseplots
- Dot plots
- Scatter plots and X-Y line plots
- Box plots
- Histograms
- Bar charts

- Pie charts

To use Graph Trace

1. From the **Analyze** menu, click **Graph Trace**.
2. Press ◀ or ▶ to move across the plot.

The data representations enlarge and appear with a bold outline as you move across them in Trace mode.

Customizing Your Workspace

Working with Color

All data points for a plotted variable display in the same color to distinguish them from the data points of other variables. Data plotted by category and split plots are automatically displayed in different colors to help you distinguish the data.

To emphasize or distinguish certain parts of your work, you can change the default color for a variable's data.

- Apply fill colors to objects, such as shading, or change the color for a variable's data points.
- Apply color to plotted lines (such as lines of regression) or movable lines.

TI-Nspire™ handhelds without color show color objects in shades of gray. The color information is preserved in the document unless you change color from the handheld. If you choose to, you can work in grayscale mode to view objects in the desktop software similarly to how they appear on the handheld.

Inserting a Background Image

When using the computer software, you can insert an image as a background for a Data & Statistics page. The file format of the image can be .bmp, .jpg, or .png.

1. From the **Insert** menu, click **Image**.
2. Navigate to the image that you want to insert.
3. Select it, and then click **Open**.

The image is inserted as a background.

For more information, see the *Working with Images* chapter.

Working with Text

The Insert Text tool lets you type text to describe details related to plots on the work area.

1. From the **Actions** menu, click **Insert Text**.

A text box opens.

2. Type notes or descriptions in the text box.

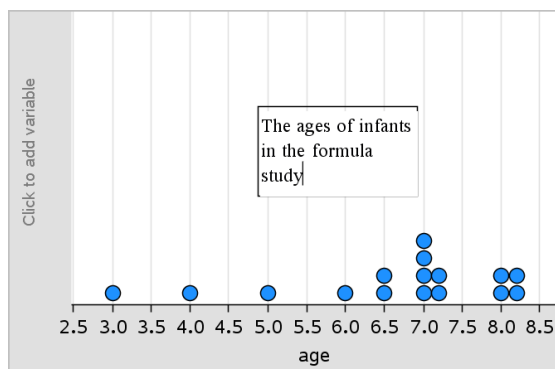

3. Customize the text to suit your needs.

- Move the pointer over the edges of the text box to drag the borders and change the width or height.
- Click and grab the text box to move it near objects that relate to the text.
- Scroll to view additional text in a box by clicking the arrows at the top and bottom edge.
- Click outside of the text entry box to exit the Text tool.
- Hide text by clicking the **Actions** menu and clicking **Hide Text**.
- Change the color of text.

Adjusting Variable Values with a Slider

In the Graphs, Geometry, and Data & Statistics applications, a slider control lets you adjust or animate the value of a numeric variable.

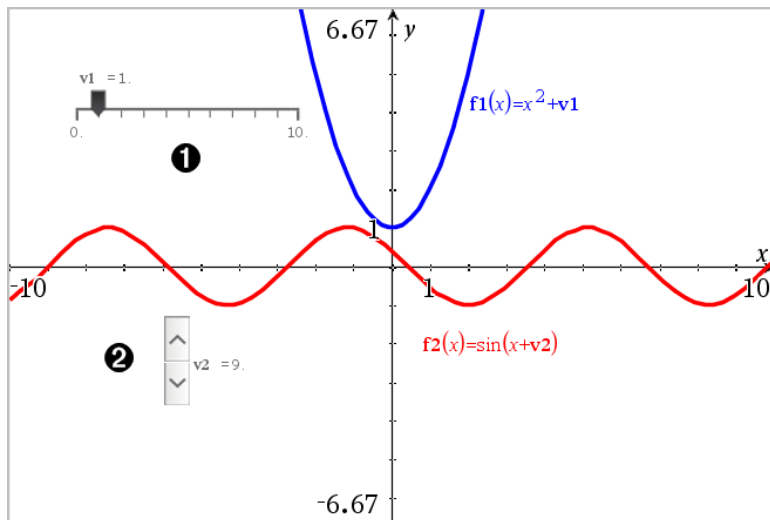

- ❶ Horizontal slider for adjusting variable v_1 .
- ❷ Minimized vertical slider for adjusting variable v_2 .

Inserting a Slider

1. Start in a Graphs, Geometry, or Data & Statistics page.
2. From the **Actions** menu, select **Insert Slider**.
The Slider Settings screen opens.

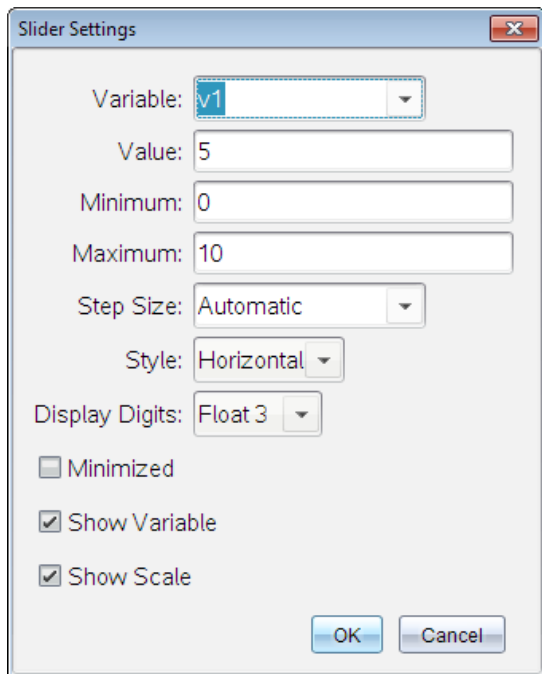

3. Enter desired values.
4. Click **OK**.

The slider is displayed in the work area. Handles on the slider let you move or stretch it. To remove the handles, click an empty space in the work area.

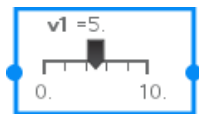

5. To adjust the variable, slide the pointer (or click the arrows on a minimized slider).

Working with the Slider

Use the options on the context menu to move or delete the slider, and to start or stop its animation. You can also change the slider's settings.

1. Display the slider's context menu.

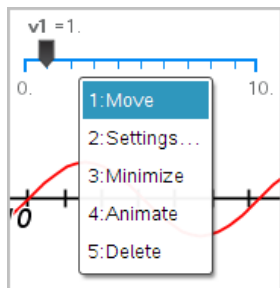

2. Click an option to select it.

Inferential Statistics

You can explore hypothesis tests and probability distributions in the Data & Statistics application after entering the data on a Lists & Spreadsheet page.

Drawing Inferential Statistics Plots

The following example uses the Draw option of the **normCdf()** function to plot a distribution model.

1. On a Lists & Spreadsheet page, select the column-formula cell (second cell from the top) in column A.
2. From the **Statistics** menu, click **Distributions**, and click **Normal Cdf**.

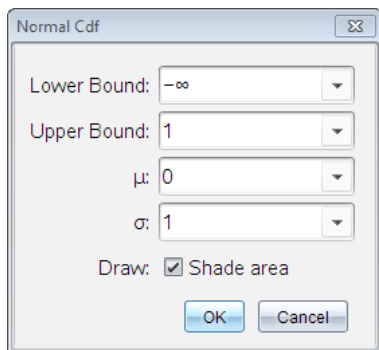

3. Type the plot parameters into the **Normal Cdf** wizard.
4. Select the **Draw** check box to see the distribution plotted and shaded in Data & Statistics.

Note: The Draw option is not available for all distributions.

5. Click OK.

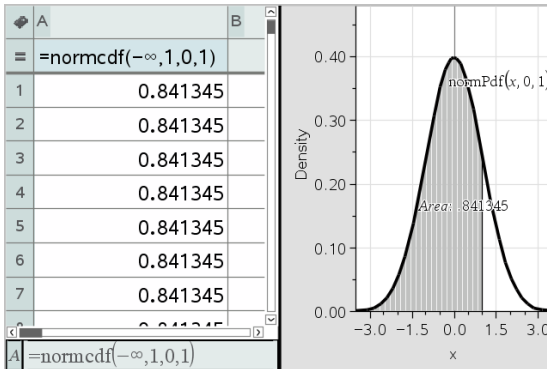

Exploring Inferential Statistics Plots

After drawing the plot in the previous example, you can explore the effect of changing the upper bound.

- ▶ On the Data & Statistics plot, drag the vertical line that represents the upper bound toward the left or right.

As you drag, the formula is updated and the shaded area is recalculated.

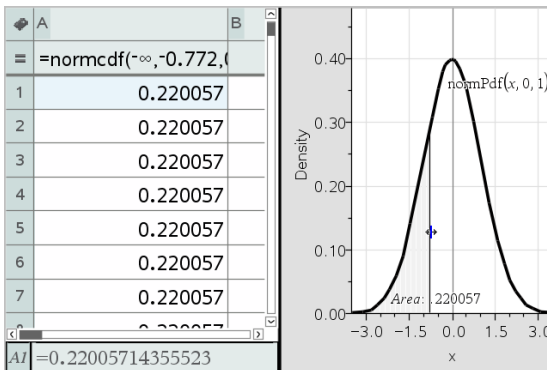

Notes Application

The Notes application lets you create and share text documents using the TI-Nspire™ handheld and computer software. Use **Notes** to:

- Create study notes to reinforce learning, demonstrate your understanding of classroom concepts, and to review for exams.
- Edit collaboratively by assigning different roles to individuals using your document so that any edits appear in a different text format.
- Create and evaluate math expressions.
- Create correctly formatted chemical formulas and equations.

Adding a Notes Page

- ▶ To start a new document with a blank Notes page:

From the main **File** menu, click **New Document**, and then click **Add Notes**.

Handheld: Press **[on]**, and select **Notes** .

- ▶ To add a Notes page in the current problem of an existing document:

From the toolbar, click **Insert > Notes**.



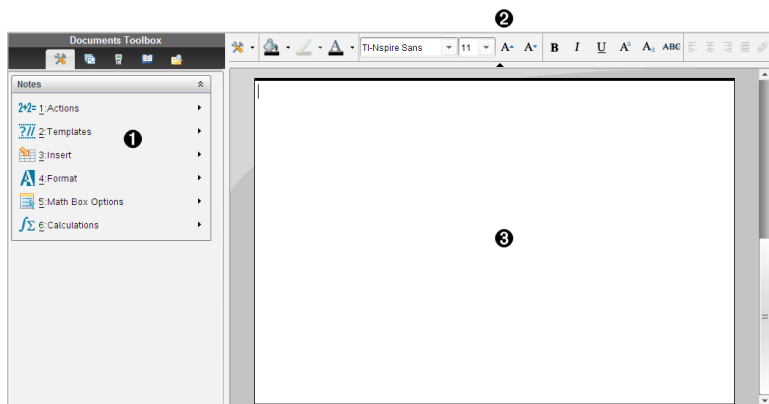

Handheld: Press **[doc]** and select **Insert > Notes**.



- ① Notes tools - Available anytime you are in the Notes work area.
- ② Text formatting toolbar -- Lets you change size, color, bold, and other text properties.
- ③ Notes work area -- The area where you type and format text.

Using Templates in Notes



Use the options on the Templates menu to select a format for your Notes page.

	Menu Option	Function
	2: Templates	
	 1: Q&A	Creates a template to enter question and answer text.
	 2: Proof	Creates a template to enter statement and reason text.
	 3: Default	Lets you type freeform text.
	 4: Hide Answer (Q&A)	Toggles to show or hide the Answer in a Q&A format.

Selecting a Template

Complete the following steps to select and apply a template:

1. From the Notes menu, click .
2. From the menu, click the template you want to apply.

Handheld: From the Notes work area, press , and then press  to display the menu options.

The Notes page is displayed in the format you selected.

Using the Q&A Template

Use the Q&A template to create questions and answers. You can show or hide the answer so you can create questions for review and hide the answers. When you use the document as a study aid, you can verify that your answers are correct.

Press **Tab** to move the text cursor between the **Question** and **Answer** areas of the template.

Using the Proof Template

The proof template provides an outline structure for statements and corresponding reasons.

Press **Tab** to move the text cursor between the **Statements** and **Reasons** areas of the template.

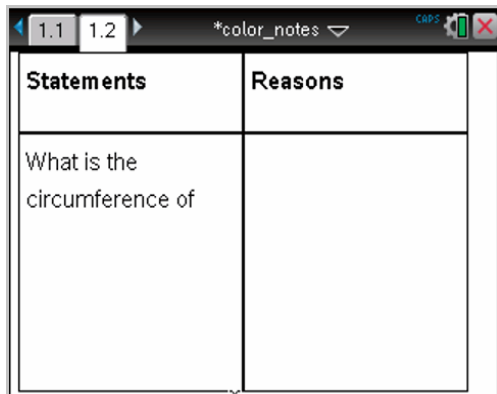

Formatting Text in Notes

Text formatting lets you apply visual properties, such as bold and italic, to your text.

- **Ordinary text.** Apply most combinations of bold, italic, underline, superscript, subscript, and strikethrough formatting. Select font and font size for any character.
- **Text in a math expression box.** Apply formatting and enter math exponents and math subscripts for variable names. Select font and font size. Font size affects all text in the box.
- **Text in a chemical equation box.** Apply formatting. Select font and font size. Font size affects all text in the box. Superscript and subscript are handled automatically.

Selecting Text

- ▶ Drag from the starting point to the ending point to select the text.

Handheld: If you are using the Q&A or Proof template, press **tab** to place the cursor in the area containing the text. Use the Touchpad to place the

cursor at the start or end of the text to be selected. Hold down **⌘**, and use the Touchpad to select the text.

Applying a Text Format

1. Select the text that you want to format.
2. On the formatting toolbar, click the formatting icons (such as **B** for bold) to toggle them, or click to select a font and font size.

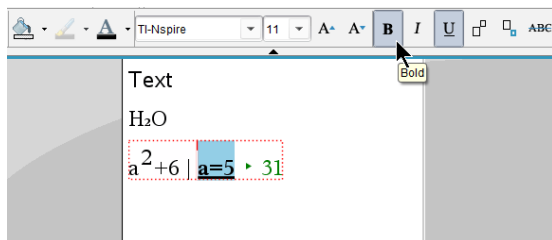

Handheld: Click **☰**, and then select **Format > Format Text**.

The changes are applied to the text as you make selections.



Note: The toolbar shows only the icons that are applicable to the type of text selected. For example, superscript (**A^B**) and subscript (**A_a**) are shown only for ordinary text.

Using Color in Notes

When working in the Notes application on a desktop, use the  (fill color) or the  (text color) options on the Documents Workspace toolbar to emphasize words, calculations, and formulas.

You can also apply color to text when working in the Notes application on the TI-Nspire™ CX handheld.

Note: If you transfer a document that contains color to a TI-Nspire™ handheld that does not support color, the colors are converted to gray scale.

Changing Text Colors

1. Select the text you want to change to another color. You can select a sentence, phrase, word, or a single letter. You can also select a math expression box, a chemical equation box, or individual characters in a calculation, formula, chemical equation, or math template.

2. From the Documents Workspace toolbar, click .
- Handheld: Press **doc**, and then click **Edit > Text Color**.
The Text Color palette opens.
3. Click a color to apply it to the selected text.

Applying a Background Color

You can apply a background color to highlight selected characters in ordinary text, text in a math expression, or text in a chemical equation box.

1. Select the text.
2. From the Documents Workspace toolbar, click the arrow next to .
- Handheld: Press **doc**, and then press **Edit > Fill Color**.
The Fill Color palette opens.
3. Click a color to apply it to the selected text.

Inserting Images

When working in the Notes application on a desktop, use the Images option on the Insert menu to add an image to a Notes page.

Note: The option for inserting an image is not available when working on a handheld. However, you can transfer a file containing an image from your computer to a TI-Nspire™ CX handheld and colors are retained. If transferred to a TI-Nspire™ handheld, the colors in the image are converted to gray scale.

1. Click **Insert > Image** from the Documents Toolbar.
The Insert Image window opens.
2. Navigate to the folder where the image is located.
3. Select the image, and then click **Open** to insert the image into the Notes work area. Valid files types are .jpg, .png, or .bmp.
4. To type text around the image, place the cursor in front of the image or after the image, and then type the text.

Resizing an Image

Complete the following steps to resize an image.

1. Click the image to select it.
2. Move the pointer to the edge of the image.





The pointer changes to a left-right arrow symbol.

3. Drag the image to make it smaller or larger.

For more information, see *Working with Images*.

Inserting Items on a Notes Page

When working with the Notes application, open the Insert menu to insert a math expression, chemical equation, shape symbol, or a comment.

Menu Name	Menu Option	Function
 3: Insert		
	 1: Math Box - ctrl M	Lets you insert a math expression.
	 2: Chem box - ctrl E	Lets you insert a chemical formula or equation.
	 2: Shape	Marks the selected text as an angle, triangle, circle, line, segment, ray, or vector.
	 3: Comment	Lets you type text that is italicized and prefaced with Teacher or Reviewer .

Inserting Comments in Notes Text

You can insert Teacher or Reviewer comments into a Notes application. Comments are easy to distinguish from the original text.

1. Define the type of comments you are inserting (Teacher or Reviewer):
 - PC: From the **Insert** menu, click **Comment**, and then click **Teacher** or **Reviewer**.
 - Handheld: While in the Notes work area, press menu to display the Notes menu. Press **Insert > Comment**, and then select either **Teacher** or **Reviewer**.
2. Type your text.

Text that you type appears in italics.

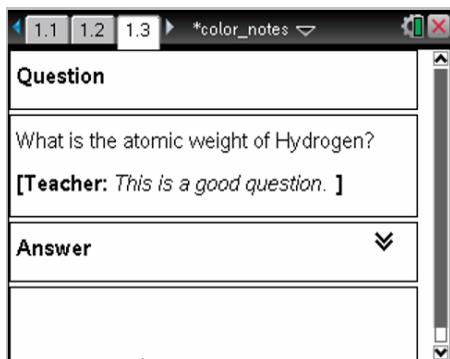

Inserting Geometric Shape Symbols

You can use geometric shape symbols to designate selected text as geometric objects, such as an angle, circle, or line segment.

To insert a shape symbol, position the cursor where you want it, and then do the following:



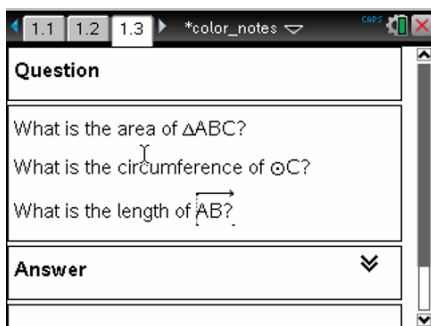

- PC: From the **Insert** menu, click **Shapes**, and then select the shape to apply.
- Handheld: Press **menu** to display the Notes menu. On the **Insert** menu, click **Shapes**, and then select the shape to apply.



Entering Math Expressions in Notes Text

You can include math expressions in Notes text, using the same tools as in other TI-Nspire™ applications.

Math expression boxes have attributes that allow you to control how the expression is displayed.

Menu Name	Menu Option	Function
 5: Math Box Options		
	 1: Math Box Attributes	<p>When a math box is selected, this option opens a dialog box allowing you to customize the math box. You can hide or show input or output, turn off calculation for the box, insert symbols, change display and angle settings, and allow or disallow the wrapping of expressions and the display of warning indicator after they have been dismissed. You can change the attributes of multiple selected math boxes at the same time.</p>
	 2: Show Warning Info	<p>Displays a warning indicator after the warning has been dismissed.</p>
	 3: Show Error	<p>Displays an error after the error has been dismissed.</p>













Entering an Expression

- In the Notes work area, place the cursor where you want the expression. Then do the following:
 - Windows®: From the **Insert** menu, click **Math Expression Box** or **Ctrl + M**.
 - Mac®: Press **⌘ + M**.
 - Handheld: Press  to open the Notes menu. Select **Insert**, and then click **Math Expression Box**.

2. Type the expression. You can use the Catalog, if necessary, to insert a function, command, symbol, or expression template.

Evaluating and Approximating Math Expressions

You can evaluate or approximate one or more expressions and display the results. You can also convert selected text and multiple math expression boxes into a single math expression box. Notes automatically updates expressions and any variables used.

Menu Name	Menu Option	Function
 1: Actions		
	 1: Evaluate - 	Evaluates the expression.
	 2: Approximate  	Approximates the expression.
	 3: Evaluate and replace	Replaces the selected part of the expression with the result.
	 4: Deactivate	Deactivates the current or selected item (box or boxes)
	 5: Deactivate All	Deactivates all boxes in the current Notes application.
	 6: Activate	Activates the current or selected previously deactivated item.
	  7: Activate All	Activates all boxes in the current Notes application.

Evaluating or Approximating an Expression

To evaluate or approximate an expression, place the cursor anywhere in the math expression box and then do the following:

- Windows®: On the **Actions** menu, click **Evaluate** or **Approximate**. You can also use **Enter** to evaluate or **Ctrl + Enter** to approximate.
- Mac®: Press **⌘ + Enter** to approximate.
- Handheld: Press  to display the Notes menu. On the **Actions** menu, select **Evaluate**.

The result replaces the expression.

Evaluating Part of an Expression

To evaluate part of an expression, select the text or part of the math expression. Then do the following:



- ▶ On the **Actions** menu, click **Evaluate and Replace**.
Handheld: Press  to open the Notes menu. Select **Actions**, and then select **Evaluate Selection**.

The result replaces the selected part only.

Breaking Long Calculations

Some calculations may take a long time. Notes indicates that the handheld is performing a long calculation by displaying a busy icon. If a calculation is taking more time than you want to spend, you can end the calculation.

To stop the function or program in progress, do the following:

- Windows®: Hold down the **F12** key and press **Enter** repeatedly.
- Mac®: Hold down the **F5** key and press **Enter** repeatedly.
- Handheld: Hold down the  key and press  repeatedly.

Showing Warnings and Errors

If a calculation in Notes results in a warning or error, you can view the warning or error again even after you have dismissed the dialog box.

To display a warning or error in Notes after you have dismissed the dialog box, do one of the following:

- Windows®: Right-click and select **Show warning info** or **Show error**.
- Mac®: **⌘ +** click and select **Show warning info** or **Show error**.

Note: You can change your settings so that warnings do not appear at all. The showing of warning indicators is controlled by the **Math Box Attributes** dialog box. See *Changing the Attributes of Math Expression Boxes*.

Converting Selected Items to Math Expression Boxes

To convert items to math expression boxes:

1. Select the text, or combination of text and existing math expression box, that you want to evaluate.
2. From the **Actions** menu, click **Convert to Math Expression Box**.

Inserting Chemical Equations in Notes

Chemical equation boxes (chem boxes) make it easy to type chemical formulas and equations, such as $\text{CH}_4 + 2\text{O}_2 \rightarrow \text{CO}_2 + 2\text{H}_2\text{O}$.

As you type in a chem box, most of the formatting work is handled automatically:

- Correct capitalization of most element symbols, such as Ag and Cl, is automatic.
- Leading digits are treated as coefficients and are shown at full size. Numbers that follow an element or a closed parenthesis are converted to subscripts.
- The equals “=” symbol is converted to a yields “→” symbol.

Notes:

- Equations in a chem box cannot be evaluated or balanced.
- Element capitalization may not work in every situation. For example, to enter carbon dioxide, CO_2 , you must manually capitalize the O. Otherwise, typing “co” would result in “Co,” the symbol for cobalt.

Entering a chemical equation

1. Position the cursor where you want the equation.
2. On the **Insert** menu, select **Chem Box**, or press **Ctrl + E**.

An empty chemical equation box is displayed.



3. Type the equation in the box. For example, to represent sulphuric acid, type h_2sO_4 , capitalizing the O manually.

The chem box automatically formats the text as you type:



4. If you need superscripts for ionic equations, type a caret symbol (^) and then the text.



5. Use parentheses to indicate whether a compound is solid (s), liquid (l), gas (g), or aqueous (aq).

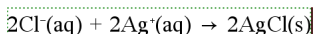

6. To exit the chem box, click anywhere outside it.

Deactivating Math Expression Boxes

Calculations are by default activated, which means that results automatically update when you evaluate or approximate an expression. If you don't want results to automatically update, you can deactivate a math expression box, group of boxes, or the entire application.

Deactivating a Box or a Group of Boxes

To deactivate a box or a group of boxes:

1. Select the box or boxes that you want to deactivate.
2. Deactivate the selected box or boxes:
 - Windows®: Click **Actions > Deactivate** (or right-click and then click **Actions > Deactivate**).
 - Mac®: Click **Actions > Deactivate** (or \mathcal{H} + click and then click **Actions > Deactivate**).
 - Handheld: Press menu to open the Notes menu. From the **Actions** menu, select **Deactivate**.

Note: You can manually update a deactivated box or boxes by selecting the box or boxes and using the process described in *Evaluating and Approximating Math Expressions*.

Deactivating All Boxes in the Notes Application

To deactivate all boxes in the Notes application:

- ▶ With a document open, place your cursor in the Notes application that you want to deactivate and select **Deactivate All**.
 - Windows®: Click **Actions > Deactivate All** or right-click and click **Actions > Deactivate All**.
 - Mac®: Click **Actions > Deactivate** or \mathbb{A} + click and click **Actions > Deactivate**.
 - Handheld: Press  to display the Notes menu. On the **Actions** menu, click **Deactivate**.

Note: When you use this option in Q&A and Proof templates, Deactivate All deactivates only the math boxes in the current work area.

Changing the Attributes of Math Expression Boxes

You can change attributes in one or more math expression boxes at the same time. Controlling the attributes in math expression boxes allows you to do the following:

- Show or hide the input or output, or prevent calculation in the box.
- Select a symbol separator using Insert Symbol.
- Choose the number of digits to display in the output of a math expression.
- Select angle settings so you can use both radian/degree and gradian angle measures in the same Notes application.
- Select whether to allow math expressions to wrap.
- Select whether to show or hide warning indicators.

To change the attributes of one or more boxes, do the following:

1. Select the box or boxes that you want to change.
2. On the **Math Box Options** menu, click **Math Box Attributes**.
3. Use the menus or selection boxes to make your selections.
4. Click **OK** to save or **Cancel** to abandon the change.

Note: Math expression boxes recalculate automatically after you have made attribute changes and saved the changes.

Undoing Changes to Math Expression Boxes





- ▶ To undo changes you have made to a math expression box, press **Ctrl+Z**.







Using Calculations in Notes

In the Notes application, the options on the Calculations menu enable you to perform calculations. The calculations are described in the following table.

Important Information to Know

- Notes does not support editing programs. Use Program Editor instead.
- Notes does not support executing Lock or Unlock commands. Use Calculator instead.
- Notes does not display intermediate results obtained using the "Disp" command. Use Calculator instead.
- Notes does not support user-defined dialog boxes obtained using the "Request," "RequestStr," or "Text" commands. Use Calculator instead.
- Notes does not support the execution of multiple statistics commands that produce stat. variables.

Menu Name	Menu Option	Function
 6: Calculations		
	 1: Define Variables	Define a variable in a Note using the Calculator application.
	 2: Number	Use tools from the Calculator Number menu, including Convert to Decimal, Approximate to Fraction, Factor, Least Common Multiple, Greatest Common Divisor, Remainder, Fraction Tools, Number Tools, and Complex Number Tools.
	X= 3: Algebra	Use tools from the Calculator Algebra menu, including Numerical Solve, Solve System of Linear Equations, Polynomial Tools.
	 4: Calculus	Use tools from the Calculus menu including Numerical Derivative at a Point, Numerical Definite

Menu Name	Menu Option	Function
		Integral, Sum, Product, Numerical Function Minimum, and Numerical Function Maximum.
	 3 (CAS): Algebra	Use tools from the Calculator Algebra menu, including Solve, Factor, Expand, Zeros, Numerical Solve, Solve System of Equations, Polynomial Tools, Fraction Tools, Convert Expressions, Trigonometry, Complex, and Extract.
	 4 (CAS): Calculus	Use tools from the Calculus menu including Derivative, Derivative at a Point, Integral, Limit, Sum, Product, Function Minimum, Function Maximum, Tangent Line, Normal Line, Arc Length, Series, Differential Equation Solver, Implicit Differentiation, and Numerical Calculations
	 5: Probability	Use tools from the Calculator Probability menu, including Factorial, Permutations, Combinations, Random, and Distributions.
	 6: Statistics	Use tools from the Calculator Statistics menu, including Stat Calculations, Stat Results, List Math, List Operations, and others.
	 7: Matrix & Vector	Use tools from the Calculator Matrix & Vector menu, including Create, Transpose, Determinant, Row-Echelon Form, Reduced Row-Echelon Form, Simultaneous, and others.
	 8: Finance	Use tools from the Calculator Finance menu, including Finance Solver, TVM Functions, Amortization, Cash Flows, Interest Conversions, and Days between Dates.
	Note: For more information, see the Calculator chapter.	

Exploring Notes with Examples

This section shows you how the Notes application works with other applications to automatically update results.

Example #1: Using Notes to Explore Roots of a Quadratic Function

1. Open a new document and select the Notes application.
2. Define a function in a math box, evaluate, and hide the output using the Math Box attributes.

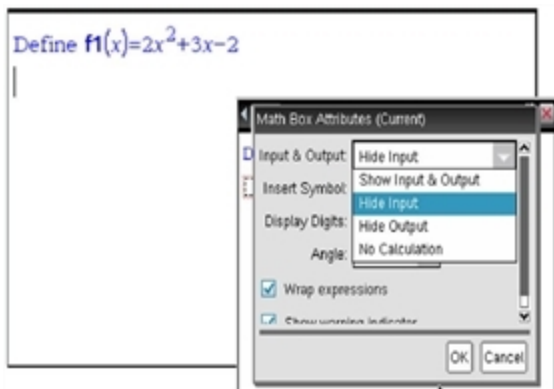

3. Type some more text; for example: **Real Roots of $f1(x)$ are:**
4. In a new math box, type: `polyRoots(f1(x), x)`.
5. Press **Enter** and hide the input of this math box by using the Math Box attributes dialog box.
6. Use the Page Layout toolbar icon to select the split layout.

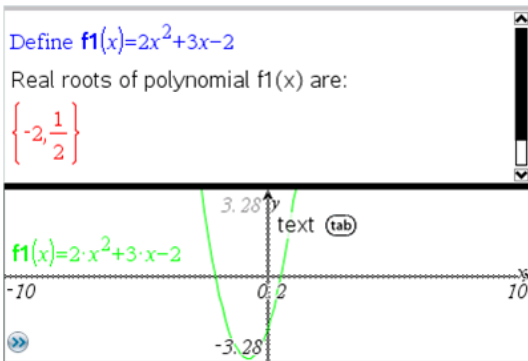

7. Add the Graph application and plot $f1(x)$.

See how the roots of $f1$ change when the function is modified in Graph.

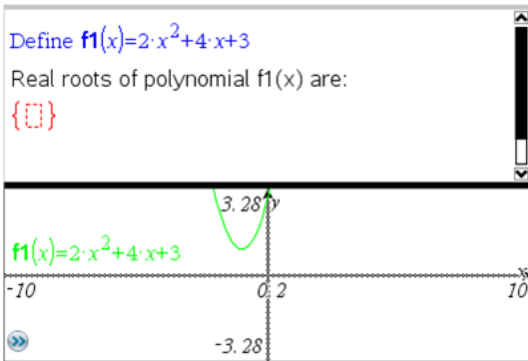

Example #2: Using Notes to Explore Data Sampling

This example shows how to create a sampling distribution of sample means drawn from a given population. We will be able to watch the sampling distribution take shape for a given sample size and describe its characteristics. You can change the population and the sample size.

- Set up the population and the sample size.
 - Type **Create sample data**:
 - Insert a math expression box and define the population. For example, type `population:=seq(n,n,1,50)`.
 - Press **Enter** and hide the output using the Math Expression Box Attributes dialog box.

- d) Insert a math expression box and define the sample size. For example, type `size:=5`.
 - e) Press **Enter** and hide the output using the Math Expression Box Attributes dialog box.
2. Set up the initialization.
- a) Type `Start taking samples:`
 - b) Insert a math expression box and set the initial values for the number of samples (*num*) and the list of sample means (*sampmeans*). Type:
`num:=0 : sampmeans := { }`
 - c) Press **Enter** and hide the output using the Math Expression Box Attributes dialog box.
 - d) Deactivate the math expression box using **Actions > Deactivate**. The deactivation will prevent the content of that math box from being overwritten when the values for num and sampmeans change. The deactivated math box will be shown with the light color background.
3. Set up Data & Statistics for the sampling.
- a) Change the page layout and insert Data & Statistics.
 - b) Click on the horizontal axis and add sampmeans list.
 - c) Change the window setting: XMin=1 and XMax = 50.
 - d) You can also set up the plot of the mean of sample means using **Analyze > Plot Value**.

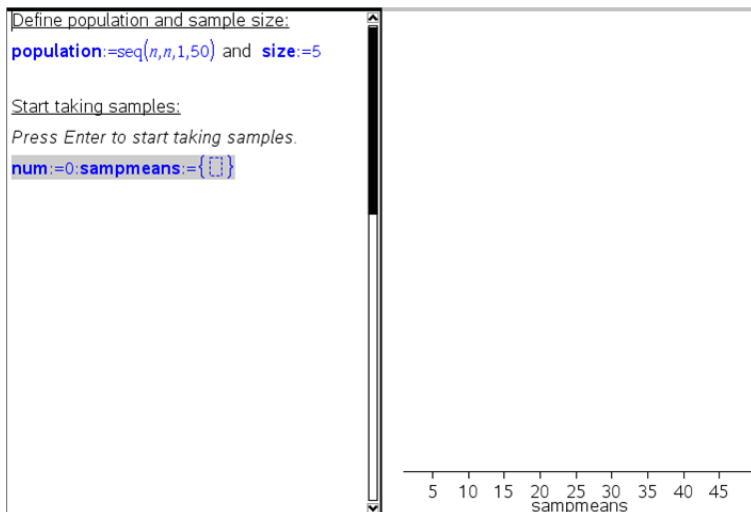

4. Enter the instructions to add data.
 - a) Type **Create new samples**:
 - b) Insert a math expression to define the sample (`sample`) and update the number of samples and the list of sample means. Type:

```
num:=num+1:sample:=randsamp(population,size):
sampmeans:=augment(sampmeans,{mean(sample)})
```
 - c) Press **Enter**, hide the output, and turn off the expression wrapping using the Math Expression Box Attributes dialog box.
 - d) Deactivate the math expression box using **Actions > Deactivate** to prevent the contents of the math box from changing when `num` and `sampmeans` values are reinitialized.
 - e) Create math expression boxes that display the current number of experiments (`num`), sample (`sample`), and the list of sample means (`sampmeans`).

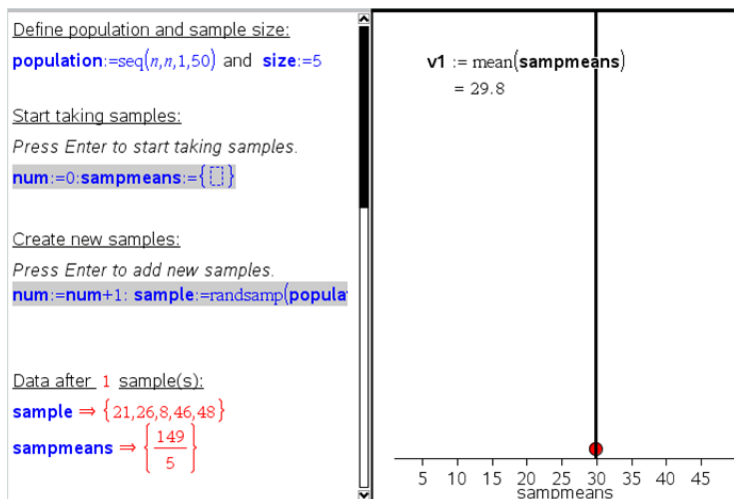

5. Now you are ready to explore. Add more samples by simply pressing **Enter** when you are in the math expression box in the "Create new samples" section.

Note: You can also automate the sampling process by using a **For ... EndFor** loop.

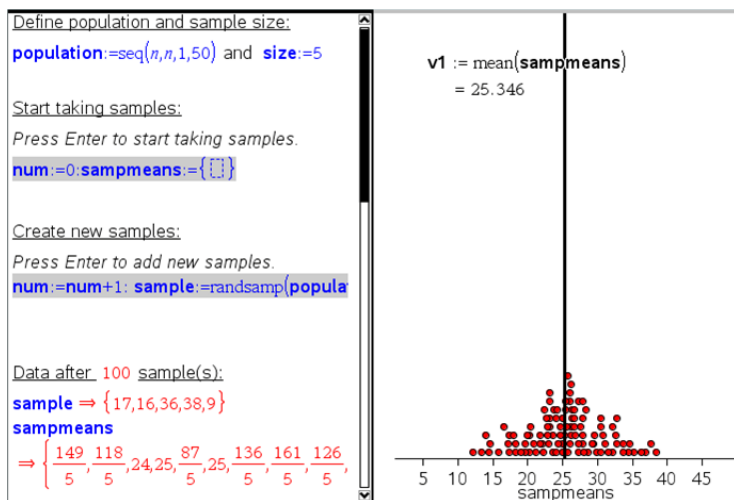

You can also change the sample size and restart the sampling.

Define population and sample size:

`population:=seq(n,n,1,50)` and `size:=3`

Start taking samples:

Press Enter to start taking samples.

`num:=0:sampmeans:={}`

Create new samples:

Press Enter to add new samples.

`num:=num+1: sample:=randsamp(popula`

Data after 100 sample(s):

`sample` \Rightarrow {17,21,20}

`sampmeans`

$\Rightarrow \left\{ \frac{97}{3}, \frac{101}{3}, 31, 24, \frac{85}{3}, \frac{100}{3}, \frac{89}{3}, \frac{77}{3}, 19, \frac{98}{3}, \dots \right\}$

`v1 :=mean(sampmeans)`
`= 25.1133`

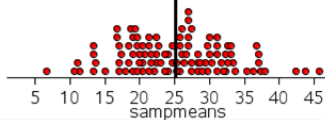

Data Collection

The Vernier DataQuest™ application is built into the TI-Nspire™ software and the operating system (OS) for handhelds. The application lets you:

- Capture, view, and analyze real-world data using a TI-Nspire™ handheld, a Windows® computer, or a Mac® computer.
- Collect data from up to five connected sensors (three analog and two digital) using the TI-Nspire™ Lab Cradle.



Important: The TI-Nspire™ CM-C Handheld is not compatible with the Lab Cradle and only supports the use of a single sensor at a time.

- Collect data either in the classroom or at remote locations using collection modes such as time-based or event-based.
- Collect several data runs for comparison.
- Create a graphical hypothesis using the Draw Prediction feature.
- Play back the data set to compare the outcome to the hypothesis.
- Analyze data using functions such as interpolation, tangential rate, or modeling.
- Send collected data to other TI-Nspire™ applications.

Adding a Vernier DataQuest™ Page





Note: The application is launched automatically when you connect a sensor.

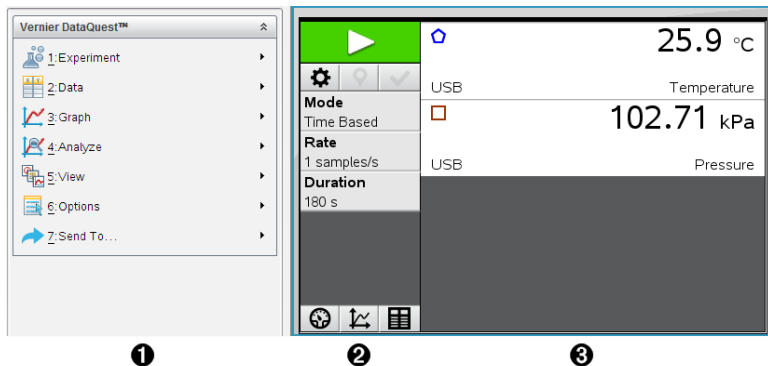

Starting a new document or problem for each new experiment ensures that the Vernier DataQuest™ application is set to its default values.

- ▶ To start a new document containing a data collection page:
From the main **File** menu, click **New Document**, and then click **Add Vernier DataQuest™**.
Handheld: Press , and select **Vernier DataQuest™** .
- ▶ To insert a new problem with a data collection page into an existing document:
From the toolbar, click **Insert > Problem > Vernier DataQuest™**.
Handheld: Press  and select **Insert > Problem > Vernier DataQuest™**.



❶ **Vernier DataQuest™ Menu.** Contains menu items for setup, collection, and analysis of sensor data.

❷ **Details view.** Contains buttons for starting data collection , changing collection settings , marking collected data , storing data sets , and tabs for managing multiple data runs.

View selection buttons let you choose from Meter view , Graph view , or Table view .

❸ **Data work area.** The information displayed here depends on the view.
Meter. Displays a list of sensors that are currently connected or set up in advance.

Graph. Displays collected data in a graphical representation, or displays the prediction before a data collection run.

Table. Displays collected data in columns and rows.

What You Must Know

Required Operating System

To use the Vernier DataQuest™ application on a TI-Nspire™ handheld, the OS must be **3.0** or higher. Screen snapshots in this document are from version 3.9 and may not match your screens exactly. To update the OS, go to education.ti.com.

Basic Steps in Performing an Experiment

These basic steps are the same no matter which type of experiment you perform.

1. Start the Vernier DataQuest™ Application.
2. Connect sensors.
3. Modify sensor settings.
4. Select the collection mode and collection parameters.
5. Collect data.
6. Stop collecting data.
7. Store the data set.
8. Save the document to save all data sets in the experiment.
9. Analyze the data.

Sending Collected Data to Other TI-Nspire™ Applications

You can send collected data to the Graphs, Lists & Spreadsheet, and Data & Statistics applications.

- ▶ From the **Send To** menu, click the name of the application.

A new page showing the data is added to the current problem.

About Collection Devices

You can select from a variety of sensors and interfaces to collect data while running the Vernier DataQuest™ application with TI-Nspire™ software.

Multi-Channel Sensor Interfaces

Multi-channel sensor interfaces let you connect more than one sensor at a time.

Sensor Interface	Description
 <p data-bbox="89 547 260 671">Texas Instruments TI-Nspire™ Lab Cradle</p>	<p data-bbox="313 169 917 227">This sensor can be used with a handheld, a computer, or as a stand-alone sensor.</p> <p data-bbox="313 244 935 335">The sensor interface allows you to connect and use one to five sensors at the same time. It can be used in the lab or at a remote collection location.</p> <p data-bbox="313 352 917 410">The Lab Cradle supports two digital sensors and three analog sensors.</p> <p data-bbox="313 428 917 519">The Lab Cradle also supports high-sample data collection sensors, such as a hand-grip heart rate or a blood pressure monitor.</p> <p data-bbox="313 536 928 597">After using the Lab Cradle as a remote sensor, you can download data to either a handheld or computer.</p>

Single-Channel Sensor Interfaces

Single-channel sensor interfaces can only connect to one sensor at a time. These sensors have either a mini-USB connector for a handheld or a standard USB connector for a computer. For a complete list of compatible sensors, see *Compatible Sensors*.

Sensor Interface	Description
 <p data-bbox="89 1161 291 1188">Vernier EasyLink®</p>	<p data-bbox="397 984 923 1075">This sensor interface is used with handhelds. It has a mini-USB connector so it can be plugged directly into the handheld.</p> <p data-bbox="397 1092 864 1119">Connect sensors to Vernier EasyLink® to:</p> <ul data-bbox="397 1136 850 1276" style="list-style-type: none"> <li data-bbox="397 1136 783 1163">• Measure barometric pressure. <li data-bbox="397 1180 819 1207">• Measure the salinity of a solution. <li data-bbox="397 1224 850 1276">• Investigate the relationship between pressure and volume (Boyles' Law).

Sensor Interface	Description
 <p>Vernier GoLink®</p>	<p>This sensor interface is used with computers. It has a standard connector so it can be plugged into a Windows® or Mac® computer.</p> <p>Connect sensors to Vernier GoLink® to:</p> <ul style="list-style-type: none"> • Measure the acidity or alkalinity of a solution. • Monitor greenhouse gases. • Measure sound level in decibels.

Types of Sensors

- **Analog sensors.** Temperature, light, pH, and voltage sensors are analog sensors and require a sensor interface.
- **Digital sensors.** Photogates, radiation monitors, and drop counters are digital sensors. These sensors can only be used with the TI-Nspire™ Lab Cradle.
- **Direct-connect USB sensors.** These sensors connect directly to a handheld or computer and do not require a sensor interface.

Sensors for Handhelds

The following lists some sensors you can use with a handheld.

Sensor	Description
 <p>Texas Instruments CBR 2™</p>	<p>This analog sensor connects directly to TI-Nspire™ handhelds through the mini-USB port. It is used to explore and graph motion.</p> <p>This sensor automatically launches the Vernier DataQuest™ application when you connect it to a handheld. Data collection begins when you select the Motion Match function.</p> <p>This sensor collects up to 200 samples per second.</p> <p>Use this sensor to:</p> <ul style="list-style-type: none"> • Measure position and speed of a person or object.

Sensor	Description
 <p>Vernier EasyTemp® temperature sensor</p>	<ul style="list-style-type: none"> • Measure the acceleration of an object. <p>This analog sensor connects directly to TI-Nspire™ handhelds through the mini-USB port and is used to collect temperature ranges. You can design experiments to:</p> <ul style="list-style-type: none"> • Collect weather data. • Record temperature changes due to chemical reactions. • Perform heat fusion studies.

Sensors for Computers

The following table lists some sensors you can use with a computer.

Sensor	Description
 <p>Vernier Go!Temp® temperature sensor</p>	<p>This analog sensor connects to the computer's USB port and is used to collect temperature ranges.</p> <p>You can use this sensor to:</p> <ul style="list-style-type: none"> • Collect weather data. • Record temperature changes due to chemical reactions. • Perform heat fusion studies.

 <p>Vernier Go!Motion® motion detector</p>	<p>This analog sensor connects to the computer's USB port and is used to measure acceleration, speed, and velocity.</p> <p>Use this sensor to:</p> <ul style="list-style-type: none"> • Measure position and speed of a person or object. • Measure the acceleration of an object.
--	--

Compatible Sensors

The following sensors can be used with the Vernier DataQuest™ application.

- 25-g Accelerometer
- 30-Volt Voltage Probe
- 3-Axis Accelerometer
- Low-g Accelerometer
- CBR 2™ - Connects directly to handheld USB port
- Go!Motion® - Connects directly to computer USB port
- Extra Long Temperature Probe
- Stainless Steel Temperature Probe
- Surface Temperature Sensor
- Ammonium Ion-Selective Electrode
- Anemometer
- Barometer
- Blood Pressure Sensor
- CO₂ Gas Sensor
- Calcium Ion-Selective Electrode
- Charge Sensor
- Chloride Ion-Selective Electrode
- Colorimeter
- Conductivity Probe
- High Current Sensor
- Current Probe
- Differential Voltage Probe
- Digital Radiation Monitor
- Dissolved Oxygen Sensor
- Dual-Range Force Sensor
- EasyTemp® - Connects directly to handheld USB port
- EKG Sensor
- Electrode Amplifier
- Flow Rate Sensor

- Force Plate
- Gas Pressure Sensor
- Go!Temp® - Connects directly to computer USB port
- Hand Dynamometer
- Hand-Grip Heart Rate Monitor
- Instrumentation Amplifier
- Light Sensor
- Magnetic Field Sensor
- Melt Station
- Microphone
- Nitrate Ion-Selective Electrode
- O₂ Gas Sensor
- ORP Sensor
- pH Sensor
- Relative Humidity Sensor
- Respiration Monitor Belt (Requires Gas Pressure Sensor)
- Rotary Motion Sensor
- Salinity Sensor
- Soil Moisture Sensor
- Sound Level Meter
- Spirometer
- Thermocouple
- TI-Light - Sold only with the CBL 2™
- TI-Temp - Sold only with the CBL 2™
- TI-Voltage - Sold only with the CBL 2™
- Tris-Compatible Flat pH Sensor
- Turbidity Sensor
- UVA Sensor
- UVB Sensor
- Vernier Constant Current System
- Vernier Drop Counter

- Vernier Infrared Thermometer
- Vernier Motion Detector
- Vernier Photogate
- Voltage Probe
- Wide-Range Temperature Probe

Connecting Sensors

Direct-connect USB sensors, such as the Vernier Go!Temp® temperature sensor (for computers) or the Vernier EasyLink® temperature sensor (for handhelds), connect directly to the computer or handheld and do not need a sensor interface.

Other sensors require a sensor interface such as the TI-Nspire™ Lab Cradle.

Connecting Directly

- ▶ Attach the cable on the sensor directly to the computer's USB port or to an appropriate port on the handheld.

Connecting through a Sensor Interface

1. Attach the sensor to the sensor interface using either the mini-USB, USB, or BT connector and the appropriate cable.
2. Attach the interface to a computer or handheld using the appropriate connector and cable.

Note: To attach a handheld to a TI-Nspire™ Lab Cradle, slide the handheld into the connector at the bottom of the Lab Cradle.

Setting Up an Offline Sensor

You can predefine meter settings for a sensor that is not currently attached to a computer or handheld.

You cannot use the sensor offline, but you can prepare the experiment for it and then attach it when ready to collect the data. This option makes it faster to share a sensor during a lesson or lab in which there are not enough sensors for everyone.

1. From the **Experiment** menu, select **Advanced Set Up > Configure Sensor > Add Offline Sensor**.

The Select Sensor dialog box opens.

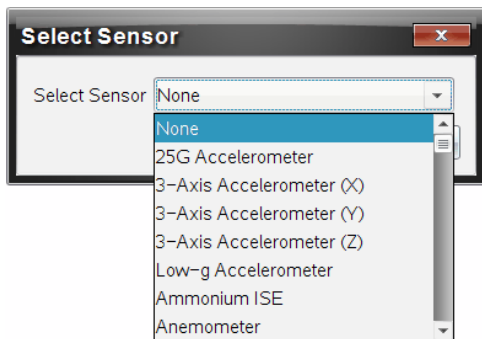

2. Select a sensor from the list.
3. Click the **Meter View** tab .
4. Click the sensor you have added, and [modify its settings](#).

The settings will be applied when you attach the sensor.

Removing an offline sensor

1. From the **Experiment** menu, select **Advanced Setup > Configure Sensor**.
2. Select the name of the offline sensor to remove.
3. Click **Remove**.

Modifying Sensor Settings

You can modify how the sensor values are displayed and stored. For example, when using a temperature sensor, you can change the unit of measure from Centigrade to Fahrenheit.

Changing Sensor Measurement Units

Measurement units depend on the selected sensor. For example, units for the Vernier Go!Temp® Temperature sensor are Fahrenheit, Celsius, and Kelvin. Units for the Vernier Hand Dynamometer (a specialized force sensor) are Newton, Pound, and Kilogram.

You can change the units before or after you collect data. The collected data reflects the new measurement unit.

1. Click Meter view  to display the connected and offline sensors.
2. Click the sensor whose units you want to change.

3. In the Meter Settings dialog box, select the unit type from the **Measurement Units** menu.

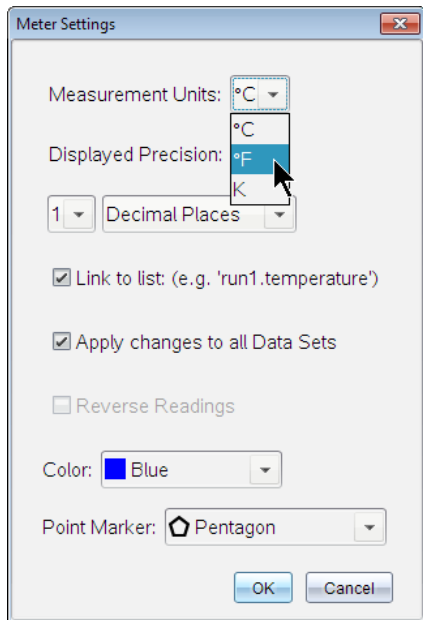

Calibrating a Sensor

When the software or handheld detects a sensor, the calibration for that sensor automatically loads. You can calibrate some sensors manually. Other sensors, such as the Colorimeter and the Dissolved Oxygen Sensor, must be calibrated to provide useful data.

There are three options for calibrating a sensor:

- Manual Entry
- Two Point
- Single Point

Refer to the sensor's documentation for specific calibration values and procedures.

Setting a Sensor to Zero

You can set the standing value of some sensors to zero. You cannot set sensors in which relative measurements such as force, motion, and pressure are common to zero. Sensors designed to measure specific environmental conditions, such as Temperature, pH, and CO₂ also cannot be set to zero.

1. Click Meter view  to display the connected and offline sensors.
2. Click the sensor that you want to set to zero.
3. In the Meter Settings dialog box, click **Zero**.

Reversing a Sensor's Readings

By default, pulling with a force sensor produces a positive force and pushing produces a negative force. Reversing the sensor allows you to display pushing as a positive force.

1. Click Meter view  to display the connected and offline sensors.
2. Click the sensor that you want to reverse.
3. In the Meter Settings dialog box, click **Reverse Readings**.

The sensor display is now reversed. In Meter View, the reverse indicator  appears after the sensor name.

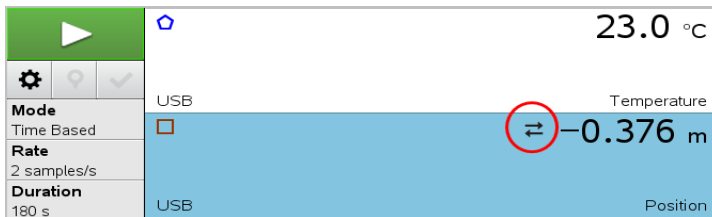

Collecting Data



Collecting Time-Based Data

The Time Based collection mode captures sensor data automatically at regular time intervals.

1. Connect the sensor or sensors.
Sensor names are added to the sensor list automatically.
2. From the **Experiment** menu, select **New Experiment**.

This removes all data and restores all meter settings to their defaults.

3. From the **Experiment** menu, select **Collection Mode > Time Based**.
 - a) Select **Rate** or **Interval** from the drop-down list, and then type the **Rate** (samples/second) or **Interval** (seconds/sample).
 - b) Type the **Duration** of the collection.

The Number of points is calculated and displayed, based on rate and duration. Note that collecting too many data points can slow system performance.
 - c) Select **Strip Chart** if you want to collect samples continuously, retaining only the last n samples. (where “ n ” is the number shown in the Number of points field.)
 4. [Modify sensor settings](#) as necessary.
 5. Click **Start Collection** .
 6. After the data has been collected, click **Stop Collection** .
- The data set run is complete.

Collecting Selected Events

Use the Selected Events collection mode to capture samples manually. In this mode, each sample is automatically assigned an event number.

1. Connect the sensor or sensors.

Sensor names are added to the sensor list automatically.
2. From the **Experiment** menu, select **New Experiment**.

This removes all data and restores all meter settings to their defaults.
3. From the **Experiment** menu, select **Collection Mode > Selected Events**.

The Selected Events Setup dialog box opens.

 - **Name**. This text is visible in the Meter View. Its first letter is displayed as the independent variable in the Graph view.
 - **Units**. This text is displayed in Graph view alongside the Name.
 - **Average over 10 s**. This option averages ten seconds of data for each point.
4. [Modify sensor settings](#) as necessary.
5. Click **Start Collection** .

The Keep Current Reading icon  becomes active. The current sensor value appears in the center of the graph.

6. Click **Keep Current Reading**  to capture each sample.

The data point is plotted, and the current sensor value appears in the center of the graph.

Note: If you selected the Averaging option, a countdown timer appears. When the counter reaches zero, the system plots the average.

7. Continue capturing until you collect all of the desired data points.
8. Click **Stop Collection** .

The data set run is complete.

Collecting Events with Entry

Use the Events with Entry collection mode to capture samples manually. In this mode, you define the independent value for each point you collect.

1. Connect the sensor or sensors.
Sensor names are added to the sensor list automatically.
2. From the **Experiment** menu, select **New Experiment**.
This removes all data and restores all meter settings to their defaults.
3. From the **Experiment** menu, select **Collection Mode > Events with Entry**.
The Events with Entry Setup dialog box opens.
 - **Name.** This text is visible in the Meter View. Its first letter is displayed as the independent variable in the Graph view.
 - **Units.** This text is displayed in Graph view alongside the Name.
 - **Average over 10 s.** This option averages ten seconds of data for each point.
4. [Modify sensor settings](#) as necessary.
5. Click **Start Collection** .

The Keep Current Reading icon  becomes active. The current sensor value appears in the center of the graph.

6. Click **Keep Current Reading**  to capture a sample.
The Events with Entry dialog box opens.

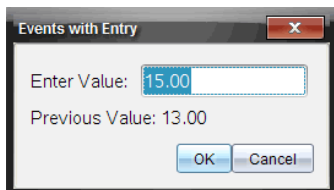

7. Type a value for the independent variable.
8. Click **OK**.

The data point is plotted, and the current sensor value appears in the center of the graph.



Note: If you selected the Averaging option, a countdown timer appears. When the counter reaches zero, the system plots the average.

9. Repeat steps 6 through 8 until you collect all of the desired data points.
10. Click **Stop Collection** .

The data set run is complete.



Collecting Photogate Timing Data

The Photogate Timing collection mode is available only when using the Vernier Photogate sensor. This sensor can time objects that pass through the gates or objects that pass outside of the gates.

1. Connect the Photogate sensor or sensors.
Sensor names are added to the sensor list automatically.
 2. From the **Experiment** menu, select **New Experiment**.
This removes all data and restores all meter settings to their defaults.
 3. From the **Experiment** menu, select **Collection Mode > Photogate Timing**.
 4. Set the collection options.
 5. [Modify sensor settings](#) as necessary.
 6. Click **Start Collection** .
 7. After the data has been collected, click **Stop Collection** .
- The data set run is complete.

Collecting Drop Counter Data

The Drop Counting collection mode is available only when using the Vernier Drop Counter optical sensor. This sensor can count the number of drops or record the amount of liquid added during an experiment.

1. Connect the Drop Counter sensor or sensors.
Sensor names are added to the sensor list automatically.
 2. From the **Experiment** menu, select **New Experiment**.
This removes all data and restores all meter settings to their defaults.
 3. From the **Experiment** menu, select **Collection Mode > Drop Counting**.
 4. Set the collection options.
 5. [Modify sensor settings](#) as necessary.
 6. Click **Start Collection** .
 7. After the data has been collected, click **Stop Collection** .
- The data set run is complete.

Using Data Markers to Annotate Data

Data markers give you a way to emphasize specific data points, such as when you change a condition. For example, you might mark a point at which a chemical is added to a solution or when heat is applied or removed. You can add a marker with or without a comment, and you can hide a comment.

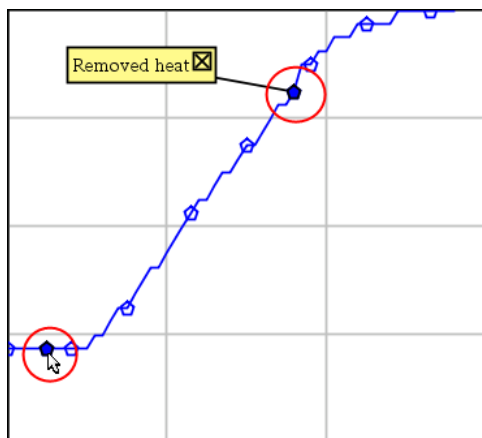

Two data markers, one with a comment displayed

4	1.5	28.4
5	2.0	28.4
6	2.5	28.4
7	3.0	28.4
8	3.5	28.4
9	4.0	28.4
10	4.5	28.4
11	5.0	28.4
12	5.5	28.5

Marker shown as red triangle in Table view

Adding a Marker During Data Collection

- ▶ Click **Add Data Marker**  to place a marker at the current data point.

Adding a Marker After Collecting Data

1. In Graph or Table view, click the point at which you want a marker.
2. Click **Add Data Marker** .

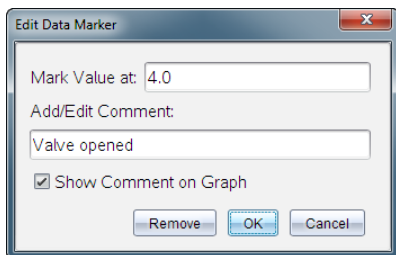

3. Complete the items in the dialog box.

Adding a Comment to an Existing Marker

1. In the Detail view, click to expand the list of markers for the data set.

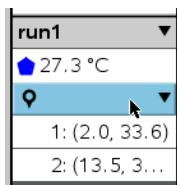

2. Click the entry for the marker that you want to change, and complete the items in the dialog box.

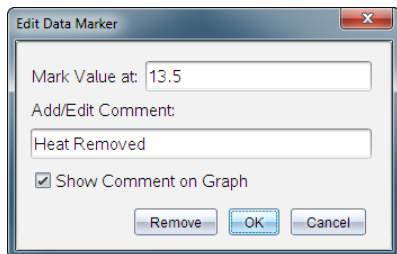

Repositioning a Data Marker

1. Click to expand the list of markers in the Detail view.

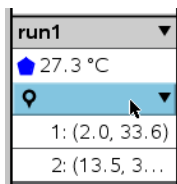

2. Click the entry for the marker that you want to change.
3. In the dialog box, type a new value for **Mark Value at**.

Moving a Data Marker's Comment in the Graph View

- ▶ Drag the comment to move it. The connecting line remains attached to the data point.

Hiding/Showing a Data Marker's Comment

- ▶ Hide a comment by clicking the X at the end of the comment.
- ▶ To restore a hidden comment:
 - a) Click to expand the list of markers in the Detail view.

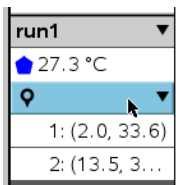

- b) Click the entry for the marker that you want to change, and check **Show Comment on Graph**.

Removing a Data Marker

1. Click to expand the list of markers in the Detail view.

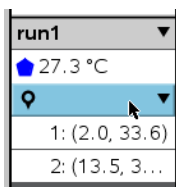

2. In the dialog box, click **Remove**.

Collecting Data Using a Remote Collection Unit

To collect information from a sensor while it is disconnected, you can set it up as a remote sensor. Only the TI-Nspire™ Lab Cradle, TI CBR 2™, and Vernier Go!Motion® support remote data collection.

You can set up a remote collection unit to start collecting:

- When you press a manual trigger on the unit, as on the TI-Nspire™ Lab Cradle
- When a delay countdown expires on a unit that supports a delayed start

Setting Up for Remote Collection

1. Save and close any open documents, and start with a new document.
2. Connect the remote collection unit to the computer or handheld.
3. Modifying Sensor Settings.
4. Click the Collection Setup button .
5. On the Collection Setup screen, check **Enable Remote Collection**.
6. Select the remote collection unit from the **Devices** list.
7. Specify the method for starting the collection:
 - To start automatically after a specified delay (on supported units), type the delay value.
 - To start when you press the manual trigger (on supported units), type a delay value of **0**. When you use a delay, the manual trigger button on the TI-Nspire™ Lab Cradle has no effect on the start of the collection.

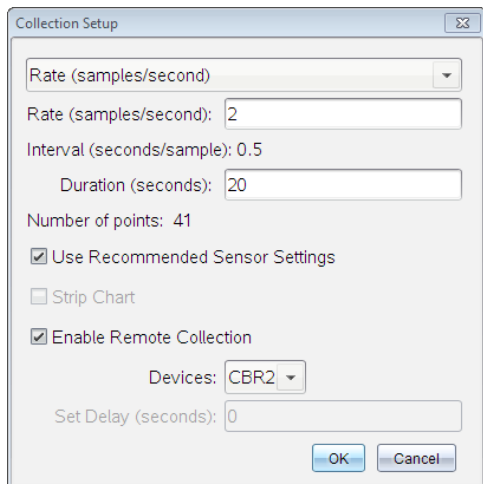

8. Click **OK**.

A message confirms that the unit is ready.

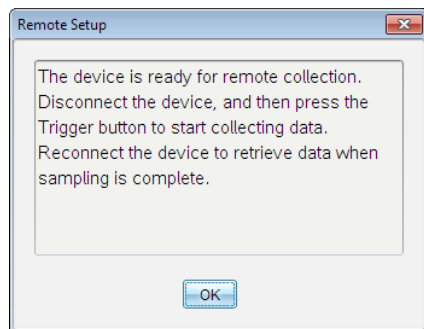

9. Disconnect the unit.

Depending on the device, LED lights may indicate its status.

Red. The system is not ready.

Amber. The system is ready but not collecting data.

Green. The system is collecting data.

10. If you are starting collection manually, press the trigger when ready. If you are starting based on a delay, the collection will start automatically when the countdown is complete.

Retrieving the Remote Data

After collecting data remotely, you transfer it to the computer or handheld for analysis.

1. Open the Vernier DataQuest™ application.
2. Attach the TI-Nspire™ Lab Cradle to the handheld or computer.

The Remote Data Detected dialog box opens.

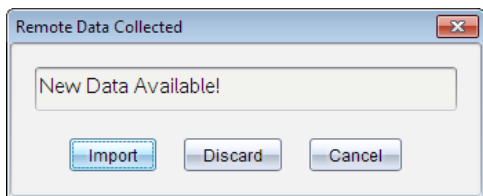

3. Click **Import**.

The data transfers to the Vernier DataQuest™ application.

Setting Up a Sensor for Automatic Triggering

To start data collection automatically based on a specific sensor reading, the TI-Nspire™ Lab Cradle and sensor must be connected.

1. Connect the sensor.
2. Click **Experiment > Advanced Set up > Triggering > Set Up**.

The Configure Trigger dialog box opens.

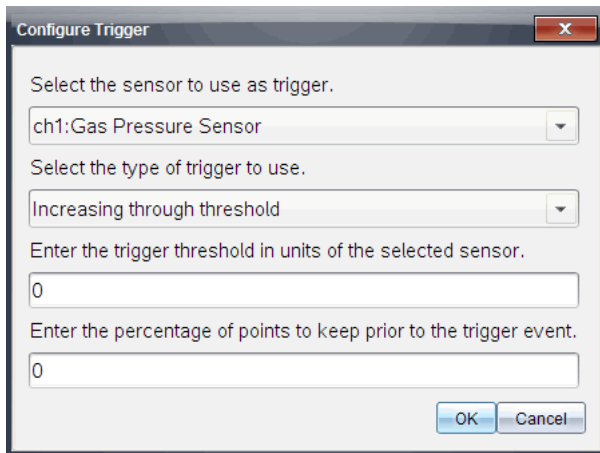

- Select the sensor from the **Select the sensor to use as trigger** drop-down list.
Note: The menu displays the sensors connected to the TI-Nspire™ Lab Cradle.
- Select one of the following from the **Select the type of trigger to use** drop-down list.
 - Increasing through threshold.** Use to trigger on increasing values.
 - Decreasing through threshold.** Use to trigger on decreasing values.
- Type the appropriate value in the **Enter the trigger threshold in units of the selected sensor** field.

When entering the trigger value, enter a value within the range of the sensor.

If you change the unit type after setting the threshold, the value automatically updates.

For example, if you use the Vernier Gas Pressure sensor with the units set as atm and you later change the units to kPa, the settings are updated.

- Type the number of data points to keep before the trigger value occurs.
- Click **OK**.

The trigger is now set and enabled if values were entered.

- (Optional) Select **Experiment > Advanced Set up > Triggering** to verify the active indicator is set to Enabled.

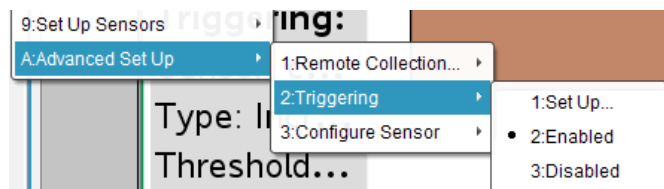

Important: When the trigger is enabled, it stays active until it is disabled or you start a new experiment.

Enabling a Disabled Trigger

If you set the trigger values in the current experiment, and then disable them, you can enable the triggers again.

To enable a trigger:

- ▶ Click **Experiment > Advanced Set Up > Triggering > Enable**.

Disabling an Enabled Trigger

To disable the active trigger.

- ▶ Click **Experiment > Advanced Set Up > Triggering > Disable**.

Collecting and Managing Data Sets

By default, the **Start Collection** button  overwrites collected data with data from the next run. To preserve each run, you can store it as a data set. After collecting multiple data sets, you can superimpose any combination of them on the Graph View.

Important: Stored data sets are lost if you close the document without saving it. If you want stored data to be available later, make sure to save the document.

Storing Data as Sets

1. Collect the data from the first run. (See Collecting Data.)
2. Click the **Store Data Set** button .



The data is stored as **run1**. A new data set, **run2**, is created for collecting the next run.

3. Click **Start Collection**  to collect data for **run2**.

Comparing Data Sets

1. Click the **Graph View** icon  to show the graph.
2. Click the Data Set Selector (near the top of the Detail View) to expand the list of data sets.

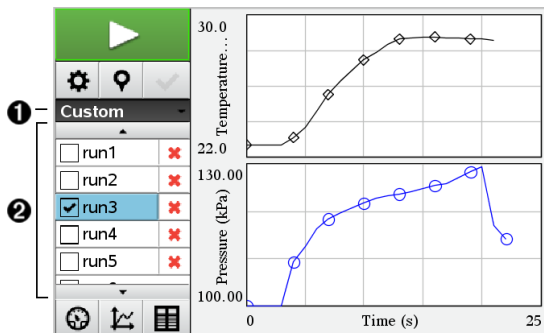

- ❶ Data Set Selector lets you expand or collapse the list.
- ❷ Expanded list shows available data sets. Scroll buttons appear as necessary to let you scroll the list.

3. Choose which data sets to view by selecting or clearing the check boxes.

The graph is rescaled as necessary to show all selected data.

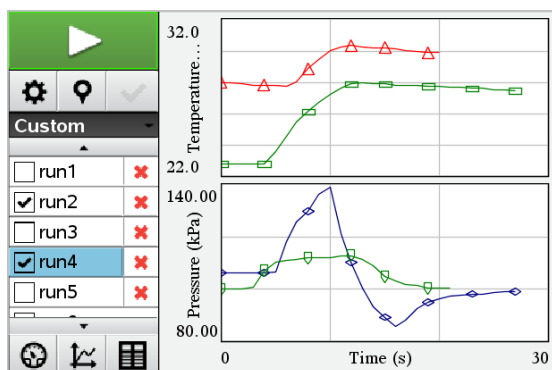

Tip: To quickly select a single data set, hold down **Shift** while clicking its name in the list. The graph shows only the selected set, and the list is collapsed automatically to help you view details of the data.

Renaming a Data Set

By default, data sets are named **run1**, **run2**, and so on. The name of each data set is displayed in the Table view.

1. Click the **Table View** icon  to show the table.

2. Display the context menu for the table view, and select **Data Set Options** > [*current name*].

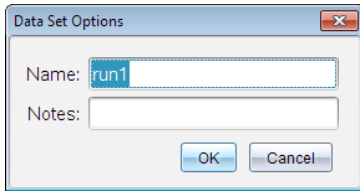

3. Type the new **Name**.
Note: The maximum character limit is 30. The name cannot contain commas.
4. (Optional) Type **Notes** about the data.

Deleting a Data Set

1. Click the **Graph View** icon  to show the graph.
2. Click the Data Set Selector (near the top of the Detail View) to expand the list of data sets.
3. Scroll the list as necessary, and then click the Delete symbol (X) next to the name of the data set.



4. Click **OK** on the confirmation message.

Expanding the View Details Area

- ▶ Drag the boundary at the right edge of the Details area to increase or decrease its width.

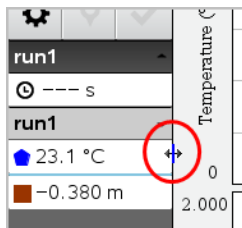

Analyzing Collected Data

In the Vernier DataQuest™ application, use Graph View to analyze data. Start by setting up graphs, and then use analysis tools such as integral, statistics, and curve fit to investigate the mathematical nature of the data.

Important: The Graph menu and Analyze menu items are only available when working in Graph View.

Finding the Area Under a Data Plot

Use Integral to determine the area under a data plot. You can find the area under all of the data or a selected region of the data.

To find the area under a data plot:

1. Leave the graph unselected to examine all the data, or select a range to examine a specific area.
2. Click **Analyze > Integral**.
3. Select the plotted column name if you have more than a single column.

The data plot area is displayed in the View Details area.

Finding the Slope

Tangent displays a measure of the rate at which the data is changing at the point you are examining. The value is labeled “Slope.”

To find the slope:

1. Click **Analyze > Tangent**.

A check mark appears in the menu next to the option.

2. Click the graph.

The examine indicator is drawn to the nearest data point.

The values of the plotted data are shown in the View details area and the All Details for Graph dialog box.

You can move the examine line by dragging, clicking another point, or using the arrow keys.

Interpolating the Value Between Two Data Points

Use Interpolate to estimate the value between two data points and to determine the value of a Curve Fit between and beyond these data points.

The examine line moves from data point to data point. When Interpolate is on, the examine line moves between and beyond data points.

To use Interpolate:

1. Click **Analyze > Interpolate**.

A check mark appears in the menu next to the option.

2. Click the graph.

The examine indicator is drawn to the nearest data point.

The values of the plotted data are shown in the View Details area.

You can shift the examine line by moving the cursor with the arrow keys or by clicking on another data point.

Generating Statistics

You can generate statistics (minimum, maximum, mean, standard deviation, and number of samples) for all the collected data or for a selected region. You can also generate a curve fit based on one of several standard models or on a model that you define.

1. Leave the graph unselected to examine all the data, or select a range to examine a specific area.
2. Click **Analyze > Statistics**.
3. Select the plotted column name if you have more than a single column. For example, run1.Pressure.

The Stats dialog box opens.

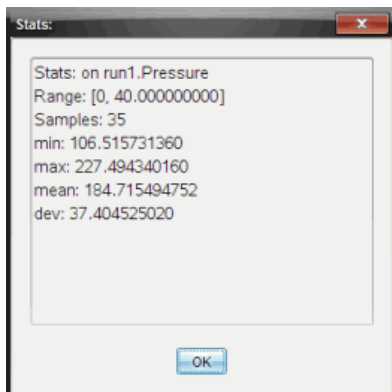

4. Review the data.
5. Click **OK**.

For information on clearing the Statistics analysis, see *Removing Analysis Options*.

Generating a Curve Fit

Use Curve Fit to find the best curve fit to match the data. Select all of the data or a selected region of data. The curve is drawn on the graph.

1. Leave the graph unselected to examine all the data, or select a range to examine a specific area.
2. Click **Analyze > Curve Fit**.
3. Select a curve fit option.

Curve Fit option	Calculated in the form:
Linear	$y = m*x + b$
Quadratic	$y = a*x^2 + b*x + c$
Cubic	$y = a*x^3 + b*x^2 + c*x + d$
Quartic	$y = a*x^4 + b*x^3 + c*x^2 + d*x + e$
Power (ax^b)	$y = a*x^b$

Curve Fit option	Calculated in the form:
Exponential (ab^x)	$y = a \cdot b^x$
Logarithmic	$y = a + b \cdot \ln(x)$
Sinusoidal	$y = a \cdot \sin(b \cdot x + c) + d$
Logistic ($d \neq 0$)	$y = c / (1 + a \cdot e^{-bx}) + d$
Natural Exponential	$y = a \cdot e^{-c \cdot x}$
Proportional	$y = a \cdot x$

The Fit Linear dialog box opens.

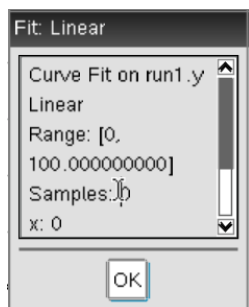

4. Click **OK**.
5. Review the data.

For information on clearing the Curve Fit analysis, see *Removing Analysis Options*.

Plotting a Standard or User-Defined Model

This option provides a manual method for plotting a function to fit data. Use one of the predefined models or enter your own.

You can also set the spin increment to use in the View Details dialog box. Spin increment is the value by which the coefficient changes when you click the spin buttons in the View Details dialog box.

For example, if you set $m=1$ as the spin increment, when you click the up spin button the value changes to 1.1, 1.2, 1.3 and so on. If you click the down spin button, the value changes to 0.9, 0.8, 0.7, and so on.

1. Click **Analyze > Model**.

The Model dialog box opens.

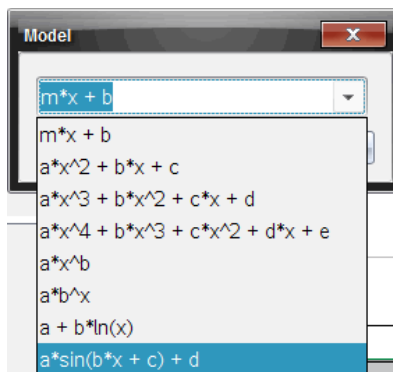

2. Type your own function.

—or—

Click to select a value from the drop-down list.

3. Click **OK**.

The Set Coefficient Values dialog box opens.

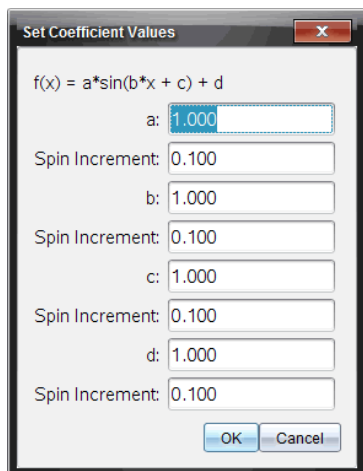

4. Type the value for the variables.
5. Type the change in value in the Spin Increment fields.
6. Click **OK**.

Note: These values are the initial values. You can also adjust these values in the View Details area.

The model is shown on the graph with adjustment options in the View Details area and in the All Details for Graph dialog box.

7. (Optional) Adjust the window setting for minimum and maximum axis values. For more information, see *Setting the Axis for One Graph*.

For information on clearing the Model analysis, see *Removing Analysis Options*.

8. Click  to make any desired adjustments to the coefficients.

–or–

Click the value in the View Details area.

This graphic is an example of a model with adjusted values.

Removing Analysis Options

1. Click **Analyze > Remove**.
2. Select the data display you want to remove.

The display you selected is removed from the graph and the View Details area.

Displaying Collected Data in Graph View

When you collect data, it is written in both the Graph and Table views. Use the Graph view to examine the plotted data.

Important: The Graph menu and Analyze menu items are only active when working in Graph View.

Selecting the Graph View

- ▶ Click the **Graph View** tab .

Viewing Multiple Graphs

Use the Show Graph menu to show separate graphs when using:

- A sensor that plots more than one column of data.
- Multiple sensors with different defined units at the same time.

In this example, two sensors (the Gas Pressure sensor and the Hand Dynamometer) were used in the same run. The following image shows the columns Time, Force, and Pressure in the Table view to illustrate why two graphs are shown.

Displaying One of Two Graphs

When two graphs are displayed, the top graph is Graph 1 and the bottom graph is Graph 2.

To display only Graph 1:

- ▶ Select **Graph > Show Graph > Graph 1**.
Only Graph 1 is displayed.

To display only Graph 2:

- ▶ Select **Graph > Show Graph > Graph 2**.
Only Graph 2 is displayed.

Displaying Both Graphs

To display both Graph 1 and Graph 2 together:

- ▶ Select **Graph > Show Graph > Both**.
Graph 1 and Graph 2 are displayed.

Displaying Graphs in the Page Layout View

Use the Page layout view when Show Graph is not the appropriate solution for showing more than one graph.

The Show Graph option is not applicable for:

- Multiple runs using a single sensor.
- Two or more of the same sensors.
- Multiple sensors that use the same column(s) of data.

To use Page Layout:

1. Open the original data set you want to see in two graph windows.
2. Click **Edit > Page Layout > Select Layout**.
3. Select the type of page layout you want to use.

4. Click **Click here to add an application**.
5. Select **Add Vernier DataQuest™**.
The Vernier DataQuest™ application is added to the second view.
6. To see separate views, click the view you want to change, and then select **View > Table**.
The new view is displayed.
7. To show the same view, click the view to change.
8. Click **View > Graph**.
The new view is displayed.

Displaying Collected Data in Table View

Table view provides another way to sort and view collected data.

Selecting the Table View

- ▶ Click the **Table View** tab .

Defining Column Options

You can name columns and define the decimal points and the precision you want to use.

1. from the **Data** menu, select **Column Options**.
Note: You can be in the Meter, Graph, or Table view and still click these menu options. The results will still be visible.
2. Click the name of the column you want to define.
The Column Options dialog box opens.

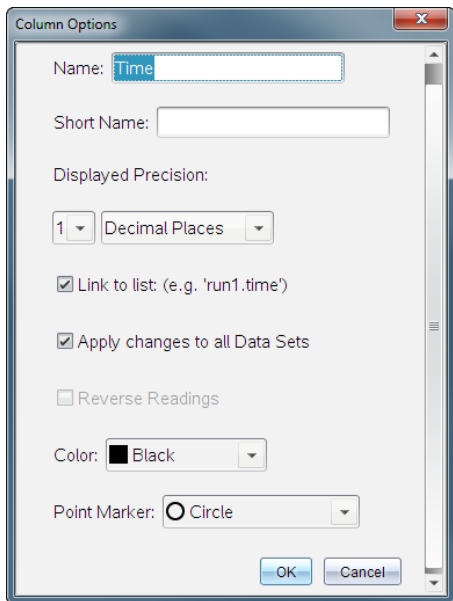

3. Type the long name for the column in the **Name** field.
4. Type the abbreviated name in the **Short Name** field.
Note: This name is displayed if the column cannot expand to display the full name.
5. Type the number of units in the **Units** field.
6. From the **Displayed Precision** drop-down list, select the precision value.
Note: The default precision is related to the precision of the sensor.
7. Select **Link to list** to link to the symbol table and make this information available to other TI-Nspire™ applications.
Note: Linking is the default for most sensors.
Important: Heart rate and blood pressure sensors require a tremendous amount of data to be useful, and the default for these sensors is to be unlinked to improve system performance.
8. Select **Apply changes to all Data Sets** to apply these settings to all data sets.
9. Click **OK**.
The column settings are now defined with the new values.

Creating a Column of Manually Entered Values

To enter data manually, add a new column. Sensor columns cannot be modified, but data entered manually can be edited.

1. Click **Data > New Manual Column**.

The Column Options dialog box opens.

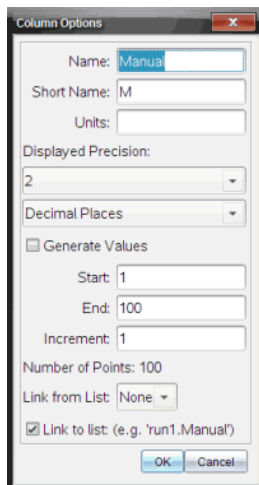

2. Type the long name for the column in the **Name** field.
3. Type the abbreviated name in the **Short Name** field.
Note: This name is displayed if the column cannot expand to display the full name.
4. Type the units to be used.
5. From the **Displayed Precision** drop-down list, select the precision value.
Note: The default precision is related to the precision of the sensor.
6. (Optional) Select **Apply changes to all Data Sets** to apply these settings to all data sets.
7. (Optional) Select **Generate Values** to automatically populate the rows.
If you select this option, complete these steps:
 - a) Type a starting value in the **Start** field.
 - b) Type an ending value in the **End** field.

c) Type the increase in value in the **Increment** field.

The number of points is calculated and shown in the Number of Points field.

8. Select **Link from list** to link to data in another TI-Nspire™ application.

Note: This list only populates when data exists in the other application and includes a column label.

9. Select **Link to list** to link to the symbol table and make this information available to other TI-Nspire™ applications.

Note: Linking is the default for most sensors.

Important: Heart rate and blood pressure sensors require a tremendous amount of data to be useful, and the default for these sensors is to be unlinked to improve system performance.

10. Click **OK**.

A new column is added to the table. This column can be edited.

Creating a Column of Calculated Values

You can add an additional column to the data set in which the values are calculated from an expression using at least one of the existing columns.

Use a calculated column when finding the derivative for pH data. For more information, see *Adjusting Derivative Settings*.

1. Click **Data > New Calculated Column**.

The Column Options dialog box opens.

Column Options

Name:

Short Name:

Units:

Displayed Precision:

Significant Figures:

Expression:

Type an expression which includes
One of the following column names:
Volume, Pressure

Link to list: (e.g. 'run1.Calculated')

2. Type the long name for the column in the **Name** field.
3. Type the abbreviated name in the **Short Name** field.

Note: This name is displayed if the column cannot expand to display the full name.

4. Type the units to be used.
5. From the **Displayed Precision** drop-down list, select the precision value.

Note: The default precision is related to the precision of the sensor.

6. Type a calculation including one of the column names in the **Expression** field.

Note: The system-provided column names are dependent on the sensor(s) selected and any changes made to the name field in Column Options.

Important: The Expression field is case-sensitive. (Example: “Pressure” is not the same as “pressure.”)

7. Select **Link to list** to link to the symbol table and make this information available to other TI-Nspire™ applications.

Note: Linking is the default for most sensors.

Important: Heart rate and blood pressure sensors require a tremendous amount of data to be useful, and the default for these sensors is to be unlinked to improve system performance.

8. Click **OK**.

The new calculated column is created.

Customizing the Graph of Collected Data

You can customize the Graph view by adding a title, changing colors, and setting ranges for the axis.

Adding a Title

When you add a title to a graph, the title is displayed in the View Details area. When you print the graph, the title prints on the graph.

1. Click **Graph > Graph Title**.

The Graph Title dialog box opens.

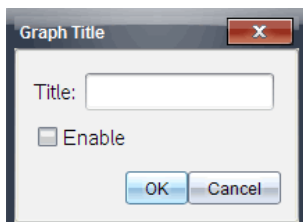

If there are two graphs in the work area, the dialog box has two title options.

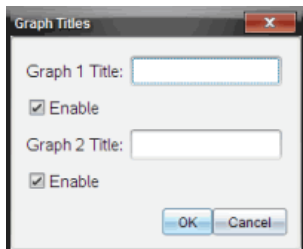

2. Type the name of the graph in the Title field.

–or–

- a) Type the name of the first graph in the Graph 1 field.

- b) Type the name of the second graph in the Graph 2 field.
3. Select **Enable** to show the title.
- Note:** Use the Enable option to hide or show the graph title as needed.
4. Click **OK**.
- The title is shown.

Setting Axis Ranges

Setting Axis Ranges for One Graph

To modify the minimum and maximum range for the x and y axis:

1. Click **Graph > Window Settings**.
- The Window Settings dialog box opens.

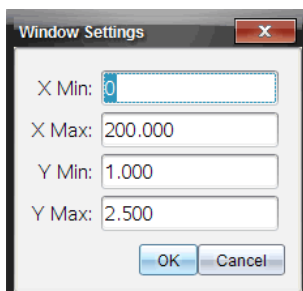

2. Type the new values in one or more of these fields:
- X Min
 - X Max
 - Y Min
 - Y Max

3. Click **OK**.
- The application uses the new values for the graph visual range until you modify the range or change data sets.

Setting Axis Ranges for Two Graphs

When working with two graphs, enter two y axis minimum and maximum values, but only one set of minimum and maximum values for the x axis.

1. Click **Graph > Window Setting**.

The Window Setting dialog box opens.

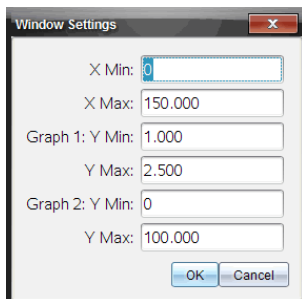

2. Type the new values in one or more of these fields:

- X Min
- X Max
- Graph 1: Y Min
- Y Max
- Graph 2: Y Min
- Y Max

3. Click **OK**.

The application uses the new values for the graph visual range until you modify the range or change data sets.

Setting the Axis Range on the Graph Screen

You can modify the minimum and maximum range for the x and y axes directly on the graph screen.

► Select the axis value that you want to change, and type a new value.

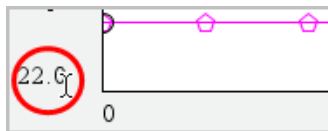

The graph is redrawn to reflect the change.

Selecting which Data Sets to Plot

1. In the Detail view on the left, click the tab immediately below the view selection buttons.

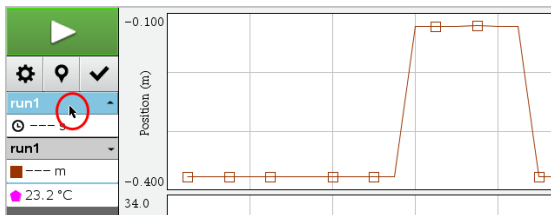

2. The Detail view shows a list of available data sets.
3. Use the check boxes to select the data sets to plot.

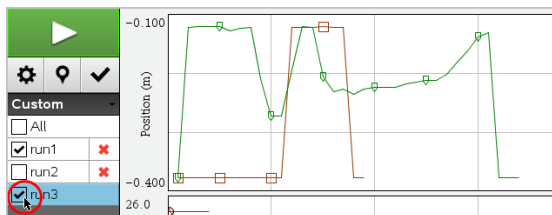

Autoscaling a Graph

Use the autoscale option to show all the points plotted. Autoscale Now is useful after you change the x and y axis range or zoom in or out of a graph. You can also define the automatic autoscale setting to use during and after a collection.

Autoscale Now Using the Application Menu

- Click **Graph > Autoscale Now**.

The graph now displays all the points plotted.

Autoscale Now Using the Context Menu

1. Open the context menu in the graph area.
2. Click **Window/Zoom > Autoscale Now**.

The graph now displays all the points plotted.

Defining Autoscale During a Collection

There are two options for using the automatic autoscaling that occurs during a collection. To choose an option:

1. Click **Options > Autoscale Settings**.

The Autoscale Settings dialog box opens.

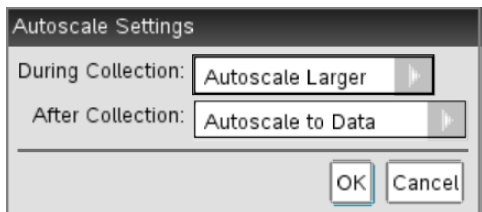

2. Click ► to open the During Collection drop-down list.
3. Select one of these options:
 - **Autoscale Larger** - Expands the graph as needed to show all points as you collect them.
 - **Do Not Autoscale** - The graph is not changed during a collection.
4. Click **OK** to save the setting.

Defining Autoscale After a Collection

You have three options for setting the automatic autoscaling that occurs after a collection. To set your choice:

1. Click **Options > Autoscale Settings**.
The Autoscale Settings dialog box opens.
2. Click ► to open the **After Collection** drop-down list.
3. Select one of these options:
 - **Autoscale to Data**. Expands the graph to show all data points. This option is the default mode.
 - **Autoscale From Zero**. Modifies the graph so all data points including the origin point are displayed.
 - **Do Not Autoscale**. The graph settings are not changed.
4. Click **OK** to save the setting.

Selecting a Range of Data

Selecting a range of data on the graph is useful in several situations, such as when zooming in or out, striking and unstriking data, and examining settings.

To select a range:

1. Drag across the graph.

The selected area is indicated by gray shading.

2. Perform one of these actions.
 - Zoom in or out
 - Strike or unstrike data
 - Examine settings

Zooming In on a Graph

You can zoom in on a subset of the collected points. You can also zoom out from a previous zoom or expand the graph window beyond the data points collected.

To zoom in on a graph:

1. Select the area you want to zoom into or use the current view.
2. Click **Graph > Zoom In**.

The graph adjusts to display only the area you selected.

The x range selected is used as the new x range. The y range autoscales to show all graphed data points in the selected range.

These images show an original view and zoom in performed multiple times (or as a selected region).

Zooming Out of a Graph

- ▶ Select **Graph > Zoom Out**.

The graph is now expanded.

If a Zoom In precedes a Zoom Out, the graph displays the original settings prior to the Zoom In.

For example, if you Zoomed In twice, the first Zoom Out would display the window of the first Zoom In. To display the full graph with all data points from multiple zoom ins, use Autoscale Now.

Setting Point Options

To indicate how often marks show on the graph and whether to use a connecting line:

1. Click **Options > Point Options**.

The Point Options dialog box opens.

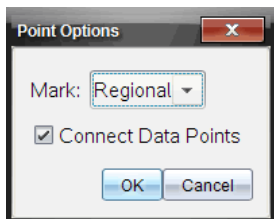

2. Select a **Mark** option from the drop-down list.
 - **None.** No point protectors.
 - **Regional.** Periodic point protectors.
 - **All.** Every data point as a point protector.
3. Select **Connect Data Points** to display a line between points.
–or–

Clear **Connect Data Points** to remove the line between points.

The following graphics show examples of some of the Point Mark options.

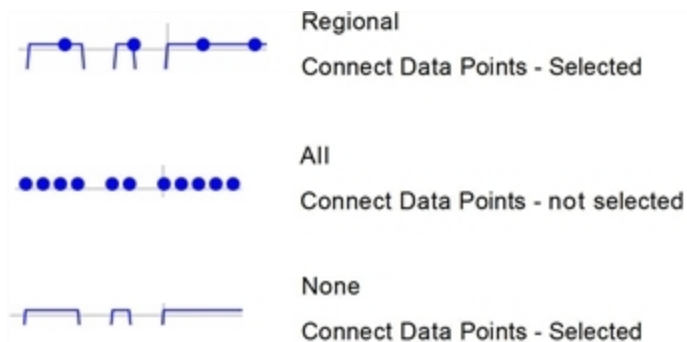

Changing a Graph's Color

1. Click the point indicator for the graph whose color you want to change.

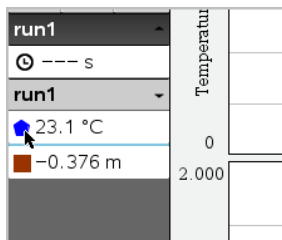

2. In the Column Options dialog box, select the new **Color**.

Selecting Point Markers

1. Right-click in the graph to open the menu.
2. Click **Point Marker**.

Note: If there is only one dependent variable column, the Point Marker option is preceded by the data set name and column name. Otherwise, the Point Marker option has a menu.

3. Select the column variable to change.
4. Select the point marker to set.

The Point Marker changes to the option selected.

Selecting an Independent Variable Column

Use the option Select X-axis Column to select the column used as the independent variable when graphing the data. This column is used for all graphs.

1. Click **Graph > Select X-axis Column**.
2. Select the variable you want to change.

The x-axis label on the graph changes and the graph is reordered using the new independent variable for graphing the data.

Selecting a Dependent Variable Column

Use the option Select Y-axis Column to select which dependent variable columns to plot on the displayed graph(s).

1. Click **Graph > Select Y-axis Column**.
2. Select one of the following:

- A variable from the list. The list is a combination of dependent variables and the number of data sets.
- **More.** Selecting More opens the Select dialog box. Use this when you want to select a combination of data set variables to graph.

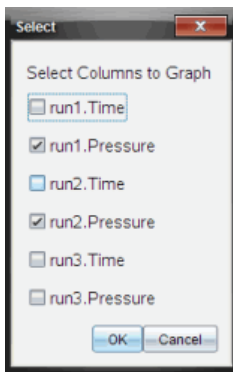

Showing and Hiding Details

You can hide or show the Details view on the left side of the screen.

- ▶ Click **Options > Hide Details** or **Options > Show Details**.

Striking and Restoring Data

Striking data omits it temporarily from the Graph view and from the analysis tools.

1. Open the data run that contains the data to be struck.
2. Click **Table View** .
3. Select the region by dragging from the starting row to the ending point.
The screen scrolls so you can see the selection.
4. Click **Data > Strike Data**.
5. Select one of the following:
 - **In Selected Region.** Strike the data from the area you selected.
 - **Outside Selected Region.** Strike all data except the area you selected.

The selected data is marked as struck in the table and is removed from the graph view.

Restoring Struck Data

1. Select the range of data to restore or if restoring all struck data, start at step two.
2. Click **Data > Restore Data**.
3. Select one of the following:
 - **In Selected Region** - Restore data in the selected area.
 - **Outside Selected Region** - Restore data outside the selected area.
 - **All Data** - Restore all data. No data selection necessary.

The data is restored.

Replaying the Data Collection

Use the Replay option to playback the data collection. This option lets you:

- Select the data set you want to replay.
- Pause the playback.
- Advance the playback by one point at a time.
- Adjust the playback rate.
- Repeat the playback.

Selecting the Data Set to Replay

You can replay one data set at a time. By default, the latest data set plays using the first column as the base column (example: time reference).

If you have multiple data sets, and want a different data set or base column than the default, you can select the data set to replay and the base column.

To select the data set to replay:



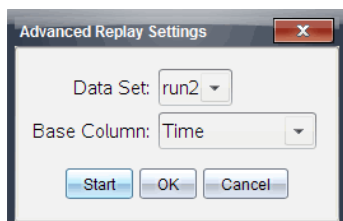

1. Click **Experiment > Replay > Advanced Settings**.

The Advanced Replay Settings dialog box opens.



2. Select the data set to replay from the Data Set drop-down list.
Note: Changing the run in the Data Set selection tool does not affect the playback choice. You must specify which data set in **Experiment > Replay > Advance Settings**.
3. (Optional) Select a new value from the Base Column drop-down list.
The selected column acts as the “Time” column for the replay.
Note: The base column should be a strictly increasing list of numbers.
4. Click **Start** to start the playback and save the settings.
Note: Data Set and Base Column options are based on the number of stored runs and the sensor type used.

Starting and Controlling the Playback

- ▶ Select **Experiment > Replay > Start Playback**.
Playback begins, and the Data Collection Control buttons change to:
 -  Pause
 -  Resume
 -  Stop
 -  Advance by One Point (enabled only during pause)

Adjusting the Playback Rate

To adjust the playback rate:

1. Select **Experiment > Replay > Playback Rate**.
The Playback Rate dialog box opens.

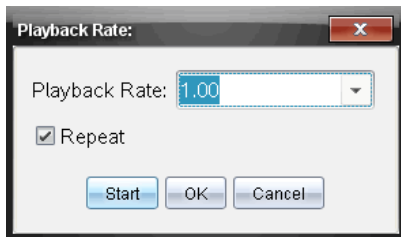

2. In the Playback Rate field, click ▼ to open the drop-down list.
3. Select the rate at which the playback will play.
Normal speed is 1.00. A higher value is faster, and a lower value is slower.

4. Select one of the following options:
 - Click **Start** to start the playback and save the settings.
 - Click **OK** to save the settings for use on the next playback.

Repeating the Playback

1. Select **Experiment > Replay > Start Playback**.
2. Click **Start** to start the playback and save the settings.

Adjusting Derivative Settings

Use this option to select the number of points to use in derivative calculations. This value affects the tangent tool, velocity, and acceleration values.

Find pH derivative settings using a calculated column.

The Vernier DataQuest™ application can determine a numeric derivative from a list of data with respect to another list of data. The data can be collected using sensors, input manually, or linked with other applications. The numerical derivative is found using a calculated column.

To determine the numerical 1st derivative of List B with respect to List A, enter the following expression in the Column Options dialog:

`derivative (B,A,1,0)` or `derivative (B,A,1,1)`

To determine the numerical 2nd derivative of List B with respect to List A, enter the following express:

`derivative (B,A,2,0)` or `derivative (B,A,2,1)`

The last parameter is either 0 or 1 depending on the method you are using. When it is 0, a weighted average is used. When it is 1, a time shifted derivative method is used.

Note: The first derivative calculation (weighted average) is what the Tangent tool uses to display the slope at a data point when examining data. (Analyze > Tangent).

Note: The derivative calculation is completely row based. It is recommended that your List A data be sorted in ascending order.

1. Click **Options > Derivative Settings**.

The Settings dialog box opens.

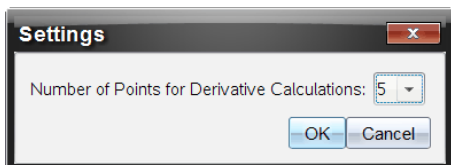

2. Select the number of points from the drop-down list.
3. Click OK.

Drawing a Predictive Plot

Use this option to add points to the graph to predict the outcome of an experiment.

1. Click the **Graph View** tab .
2. From the **Analyze** menu, select **Draw Prediction > Draw**.
3. Click each area in which you want to place a point.
4. Press **Esc** to release the drawing tool.

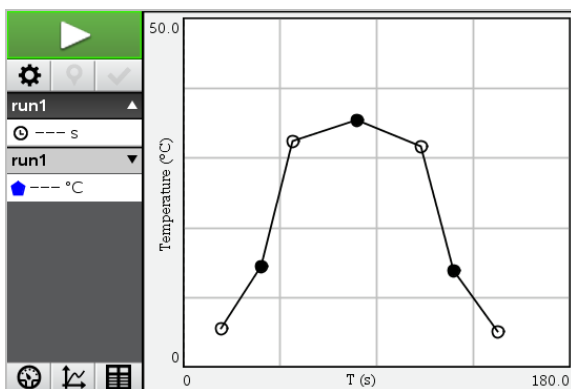

5. To clear the drawn prediction, click **Analyze > Draw Prediction > Clear**.

Using Motion Match

Use this option to create a randomly generated plot when creating position-versus-time or velocity-versus-time graphs.

This feature is only available when using a motion detector such as the CBR 2™ sensor or the Go!Motion® sensor.

Generating a Motion Match Plot

To generate a plot:

1. Attach the motion detector.
2. Click **View > Graph**.
3. Click **Analyze > Motion Match**.
4. Select one of the following options:
 - **New Position Match**. Generates a random position plot.
 - **New Velocity Match**. Generates a random velocity plot.

Note: Continue selecting a new position or a new velocity match to generate a new random plot without removing the existing plot.

Removing a Motion Match Plot

To remove the generated plot:

- ▶ Click **Analyze > Motion Match > Remove Match**.

Printing Collected Data

You can only print from the computer. You can print any single displayed active view, or with the Print All option:

- One data view.
- All of the data views.
- A combination of the data views.

The Print All option has no effect on applications outside of the Vernier DataQuest™ application.

Printing Data Views

To print a data view:

1. On the main menu (top of the window), click **File > Print**.
The Print dialog box opens.

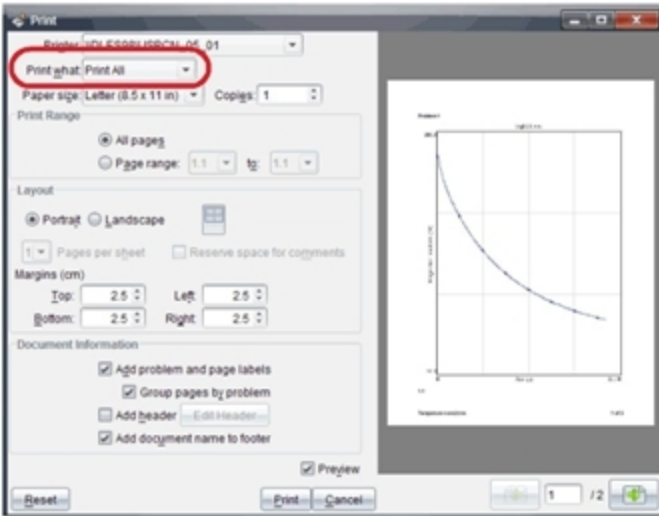

2. Select **Print All** from the Print what drop-down list.
3. Select additional options, if needed.
4. Click **Print** to send the document to the printer.

Setting Options for the Print All Feature

1. Click **Options > Print All Settings**.

The Print All Settings dialog box opens.

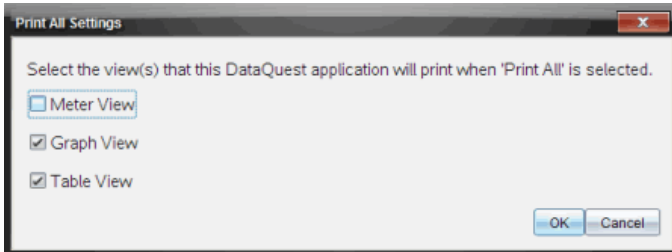

2. Select the views you want to print.
 - **Print Current View.** The current view is sent to the printer.
 - **Print All Views.** All three views (Meter, Graph, and Table) are sent to the printer.
 - **More.** Only the views you select are sent to the printer.

3. Click **OK**.

The Print All Settings are now complete and can be used when printing.

Libraries

A library is a TI-Nspire™ document that contains a collection of variables, functions, and/or programs that have been defined as library objects.

Unlike ordinary variables, functions, and programs, which can be used only within a single problem (the problem in which they are defined), library objects are accessible from any document. You can even create public library objects that appear in the TI-Nspire™ Catalog.

For example, suppose you have created library document **matrix** containing public library function **diagwithtrace()** and a private library function **errmsg()**.

Function **diagwithtrace()** displays the diagonal of a square matrix and calculates the trace of the matrix. If its input is not a square matrix, the function calls **errmsg()**, which should then return an appropriate error string.

```
Define LibPub diagwithtrace(m)=  
Func  
© diagwithtrace(mat): diagonal with trace  
If rowDim(m)≠colDim(m) Then  
    Return errmsg("not_square")  
Else  
    Disp diag(m)  
    Return trace(m)  
EndIf  
Define LibPriv errmsg(msgcode)=  
Func  
© Private library function errmsg(msgcode)  
...  
If msgcode="not_square" Then  
    Return "Error: matrix is not square"  
EndIf  
...  
EndFunc
```

You could then use the following syntax to display the diagonal and calculate the trace of matrix *m* defined in the current problem:

```
matrix\diagwithtrace (m)
```

Creating Libraries and Library Objects

A document is regarded as a library when it is saved or copied to the designated library folder. The default location is:

- Windows®: My Documents\TI-Nspire\MyLib.
- Mac®: Documents/TI-Nspire/MyLib.
- Handheld: MyLib

If the folder has been inadvertently deleted, you must create it before attempting to use libraries.

You can define library objects using either the Program Editor or the Calculator application. Library objects must be defined with a **Define** command and must reside in the first problem of a library document.

Note: If you use the Program Editor to define a library function or program, you must store the object and also save the document. Saving the document does not automatically store the object. For more information, see *Programming*.

Naming restrictions apply to library documents and library objects.

- A library document name must be a valid variable name between 1 and 16 characters long, and it must not contain a period or begin with an underscore.
- A library object name must be a valid variable name between 1 and 15 characters long. It must not contain a period and must not begin with an underscore.

Private and Public Library Objects

When you define a library object, you designate it as private (LibPriv) or public (LibPub).

Define a=5

a is not a library object.

Define LibPriv b={1,2,3}

b is a private library object.

Define LibPub func1(x)=x^2 - 1

func1 is a public library object.

A **Private** library object does not appear in the Catalog, but you can access it by typing its name. Private objects serve well as building blocks that perform

basic, low-level tasks. Typically, private library objects are called upon by the public functions and programs.



A **Public** library object appears in the Catalog's library tab after you refresh the libraries. You can access a public library object through the Catalog or by typing its name.

Mac® only: In version 1.4 of the software, a library document name cannot contain extended characters, such as Ö, á, or ñ.

Note: In library programs and functions defined as public, a comment line (©) immediately following the **Prgm** or **Func** line is automatically displayed as help in the Catalog. You could, for example, show a syntax reminder there.

Using Short and Long Names

Anytime you are in the same problem where an object is defined, you can access it by entering its short name (the name given in the object's **Define** command). This is the case for all defined objects, including private, public, and non-library objects.

You can access a library object from any document by typing the object's long name. A long name consists of the name of the object's library document followed by a backslash "\ " followed by the name of the object. For example, the long name of the object defined as **func1** in the library document **lib1** is **lib1\func1**. To type the "\ " character on the handheld, press  .

Note: If you cannot remember the exact name or the order of arguments required for a private library object, you can open the library document or use the Program Editor to view the object. You also can use **getVarInfo** to view a list of objects in a library.

Using Library Objects

Before using a library variable, function, or program, make sure that these steps have been followed:

- The object has been defined with the **Define** command, and the command specifies either the **LibPriv** or **LibPub** attribute.
- The object resides in the first problem of a library document. The document must reside in the designated library folder and must meet the naming requirements.

- If you defined the object using the Program Editor, it has been stored using **Check Syntax & Store** from the Program Editor menu.
- The libraries have been refreshed.

Refreshing the Libraries

- ▶ Refresh libraries to make the library objects available to your documents.
 - From the **Tools** menu, click **Refresh Libraries**.

Handheld: Press **ctrl** **menu** and click **Refresh Libraries**.

Using a Public Library Object

1. Refresh the libraries.
2. Open the TI-Nspire™ application in which you want to use the variable, function or program.

Note: All applications can evaluate functions, but only the Calculator and Notes applications can run programs.

3. Open the Catalog and use the library tab to find and insert the object.
4. If arguments are required, type them inside the parentheses.

Using a Private Library Object

1. Refresh the libraries.
2. Open the TI-Nspire™ application in which you want to use the variable, function, or program.

Note: All applications can evaluate functions, but only the Calculator and Notes applications can run programs.

3. Type the name of the object, such as `lib1\func1()`.

In case of a function or program, always follow the name with parentheses. To type the “\” character on the handheld, press **⇧shift** **÷**.

4. If arguments are required, type them inside the parentheses.

Creating Shortcuts to Library Objects

You can make the objects in a library more easily accessible by using **libShortcut()** to create shortcuts to them. This creates a variable group in the current problem that contains references to all the objects in the specified library document. You can choose to include or exclude the private library objects.

For example, suppose the library document `linalg` contains functions named `clearmat`, `cofactor`, `gausstep`, `help`, `inversestep`, `kernelbasis`, `rank`, and `simultstep`. Executing `libShortcut("linalg","la")` would create a variable group containing the following members:

la.clearmat
la.cofactor
la.gausstep
la.help
la.inversestep
la.kernelbasis
la.rank
la.simultstep

You can refer to those library objects from within the current problem by typing their variable names or by selecting them from the Variables menu.

For more details about using `libShortcut()`, see the *Reference Guide*.

Included Libraries

To help you get started with libraries, the TI-Nspire™ Software installation includes a library document with useful Linear Algebra functions. The library is named `linalg` or `linalgCAS` and is installed in the designated library folder.

Note: Updating the handheld's operating system or reinstalling the computer software places all included libraries in the default folder. If you have edited an object in an included library or replaced an included library with your own document of the same name, updating or reinstalling will overwrite your changes. This could also happen after batteries are replaced or the handheld system is reset.

Restoring an Included Library

If you inadvertently delete or overwrite an included library, you can restore it from the installation DVD.

1. Open the DVD, and navigate to the **libs** folder.
2. Identify the library file to restore, such as `linalg.tns` or `linalgCAS.tns` for the linear algebra library.
3. Copy the file.

- Windows®: Copy the file to your designated library folder. The default location is **My Documents\TI-Nspire\MyLib**.
 - Mac®: Copy the file to your designated library folder. The default location is **Documents/TI-Nspire/MyLib**.
 - Handheld: Connect the handheld to your computer, open the TI-Nspire™ software, and copy the library file to the handheld's **MyLib** folder.
4. Activate the new library objects.
- From the TI-Nspire™ Software **Tools** menu, click **Refresh Libraries**.
Handheld: Press ctrl menu, and click **Refresh Libraries**.

Getting Started with the Program Editor

You can create user-defined functions or programs by typing definition statements on the Calculator entry line or by using the Program Editor. The Program Editor offers some advantages, and it is covered in this section. For more information, see *Calculator*.

- The editor has programming templates and dialog boxes to help you define functions and programs using correct syntax.
- The editor lets you enter multiple-line programming statements without requiring a special key sequence to add each line.
- You can easily create private and public library objects (variables, functions, and programs). For more information, see *Libraries*.

Launching the Program Editor

- ▶ To add a new Program Editor page in the current problem:

From the toolbar, click **Insert > Program Editor > New**.

Handheld: Press **[doc]** and select **Insert > Program Editor > New**.

Note: The editor is also accessible from the **Functions & Programs** menu of a Calculator page.

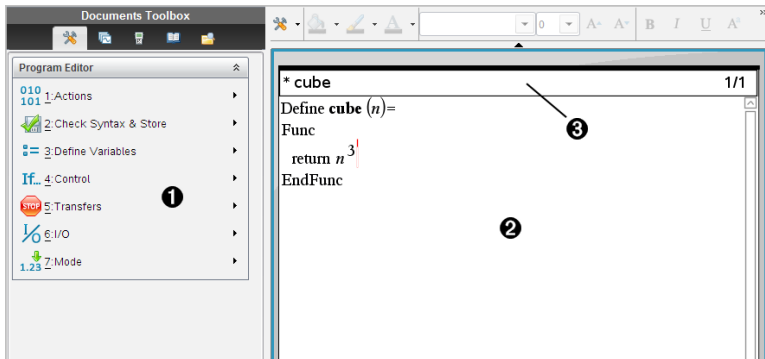

- 1 Program Editor menu - This menu is available anytime you are in the Program Editor work area using the Normal view mode.
- 2 Program Editor work area

- 3 Status line shows line-number information and the name of the function or program being edited. An asterisk (*) indicates that this function is “dirty,” which means that it has changed since the last time its syntax has been checked and it has been stored.

Defining a Program or Function

Starting a new Program Editor

1. Make sure you are in the document and problem in which you want to create the program or function.
2. Click **Insert** button  on the application toolbar, and select **Program Editor > New**. (On the handheld, press `doc` and select **Insert > Program Editor > New**.)

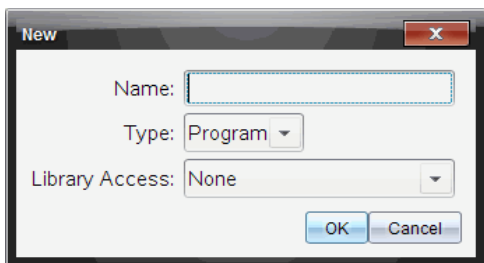

3. Type a name for the function or program you are defining.
4. Select the **Type (Program or Function)**.
5. Set the **Library Access**:
 - To use the function or program only from the current document and problem, select **None**.
 - To make the function or program accessible from any document but not visible in the Catalog, select **LibPriv**.
 - To make the function or program accessible from any document and also visible in the Catalog, select **LibPub (Show in Catalog)**. For more information, see *Libraries*.
6. Click **OK**.

A new instance of the Program Editor opens, with a template matching the selections you made.

```
prgm1 0/1
Define prgm1()=
Prgm
EndPrgm
```

Entering Lines into a Function or Program

The Program Editor does not execute the commands or evaluate expressions as you type them. They are executed only when you evaluate the function or run the program.

1. If your function or program will require the user to supply arguments, type parameter names in the parentheses that follow the name. Separate parameters with a comma.

```
* prgm1 0/1
Define prgm1(a,b)=
Prgm
EndPrgm
```

2. Between the Func and EndFunc (or Prgm and EndPrgm) lines, type the lines of statements that make up your function or program.

```
* prgm1 3/3
Define prgm1(a,b)=
Prgm
  Disp "a=",a
  Disp "b=",b
  Disp "a^b=",a^b
EndPrgm
```

- You can either type the names of functions and commands or insert them from the Catalog.
- A line can be longer than the width of the screen; if so, you might have to scroll to view the entire statement.
- After typing each line, press **Enter**. This inserts a new blank line and lets you continue entering another line.
- Use the **◀**, **▶**, **▲**, and **▼** arrow keys to scroll through the function or program for entering or editing commands.

Inserting Comments

A comment symbol (©) lets you enter a remark. Comments can be useful to someone viewing or editing the program. Comments are not displayed when the program runs, and they have no effect on program flow.

```
Define LibPub volcyl(ht,r) =  
Prgm  
©volcyl(ht,r) => volume of cylinder ❶  
  Disp "Volume =", approx( $\pi \cdot r^2 \cdot ht$ )  
©This is another comment.  
EndPrgm
```

- ❶ Comment showing required syntax. Because this library object is public and this comment is the first line in a Func or Prgm block, the comment is displayed in the Catalog as help. For more information, see *Libraries*.

To insert a comment:

1. Position the cursor at the end of the line in which you want to insert a comment.
2. From the **Actions** menu, click **Insert Comment**.
3. Type the text of the comment after the © symbol.

Checking Syntax

The Program Editor lets you check the function or program for correct syntax.

- From the **Check Syntax & Store** menu, click **Check Syntax**.

If the syntax checker finds any syntax errors, it displays an error message and tries to position the cursor near the first error so you can correct it.

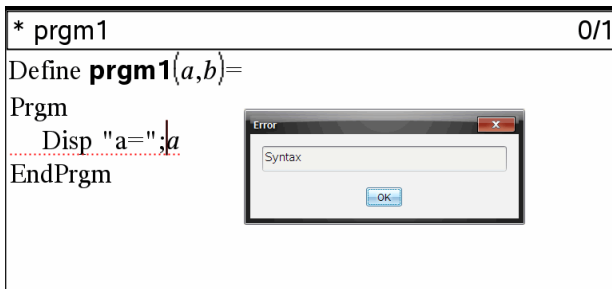

Storing the Function or Program

You must store your function or program to make it accessible. The Program Editor automatically checks the syntax before storing.

An asterisk (*) is displayed in the upper left corner of the Program Editor to indicate that the function or program has not been stored.

- ▶ From the **Check Syntax & Store** menu, click **Check Syntax & Store**.

If the syntax checker finds any syntax errors, it displays an error message and tries to position the cursor near the first error.

If no syntax errors are found, the message “Stored successfully” is displayed in the status line at the top of the Program Editor.

Note: If the function or program is defined as a library object, you must also save the document in the designated library folder and refresh libraries to make the object accessible to other documents. For more information, see *Libraries*.

Viewing a Program or Function

1. From the **Actions** menu, click **View**.

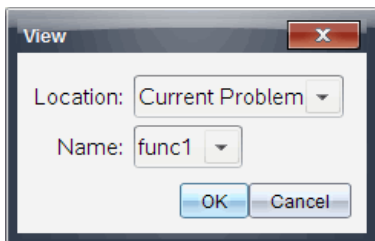

2. If the function or program is a library object, select its library from the **Location** list.
3. Select the function or program name from the **Name** list.
The function or program is displayed in a viewer.

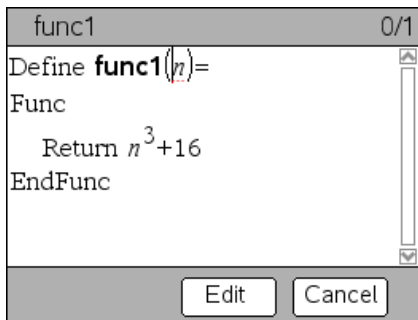

4. Use the arrow keys to view the function or program.
5. If you want to edit the program, click **Edit**.

Handheld: Press **tab** to highlight **Edit**, and then press **enter**.

Note: The **Edit** selection is available only for functions and programs defined in the current problem. To edit a library object, you must first open its library document.

Opening a Function or Program for Editing

You can open a function or program from the current problem only.

Note: You cannot modify a locked program or function. To unlock the object, go to a Calculator page and use the **unLock** command.

1. Display the list of available functions and programs.
 - From the **Actions** menu, click **Open**.



2. Click the item to open.

Importing a Program from a Library

You can import a function or program defined as a library object into a Program Editor within the current problem. The imported copy is not locked, even if the original is locked.

1. From the **Actions** menu, click **Import**.

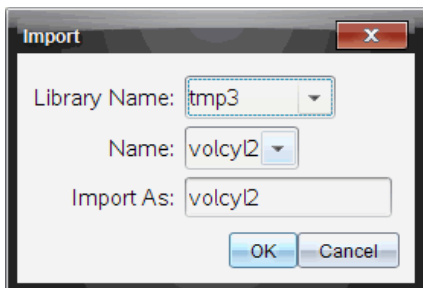

2. Select the **Library Name**.
3. Select the **Name** of the object.
4. If you want the imported object to have a different name, type the name under **Import As**.

Creating a Copy of a Function or Program

When creating a new function or program, you might find it easier to start with a copy of the current one. The copy that you create is not locked, even if the original is locked.

1. From the **Actions** menu, click **Create Copy**.
2. Type a new name, or click **OK** to accept the proposed name.
3. If you want to change the access level, select **Library Access**, and select a new level.

Renaming a Program or Function

You can rename and (optionally) change the access level of the current function or program.

1. From the **Actions** menu, click **Rename**.

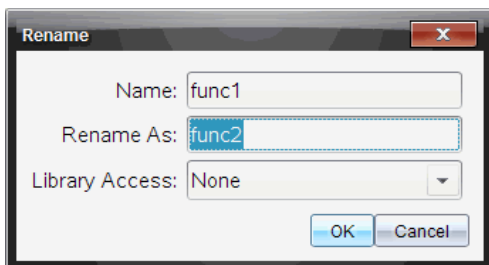

2. Type a new name, or click **OK** to accept the proposed name.
3. If you want to change the access level, select **Library Access**, and select a new level.

Changing the Library Access Level

1. From the **Actions** menu, click **Change Library Access**.

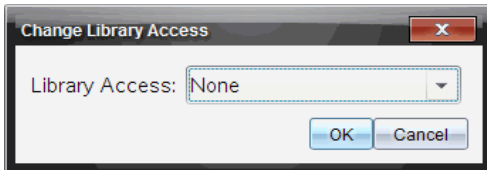

2. Select the **Library Access**:
 - To use the function or program only from the current Calculator problem, select **None**.
 - To make function or program accessible from any document but not visible in the Catalog, select **LibPriv**.
 - To make the function or program accessible from any document and also visible in the Catalog, select **LibPub**.

Finding Text

1. From the **Actions** menu, click **Find**.

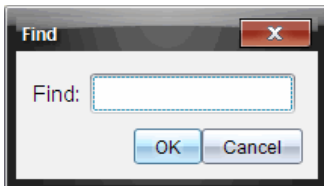

2. Type the text that you want to find, and click **OK**.
 - If the text is found, it is highlighted in the program.
 - If the text is not found, a notification message is displayed.

Finding and Replacing Text

1. From the **Actions** menu, click **Find and Replace**.

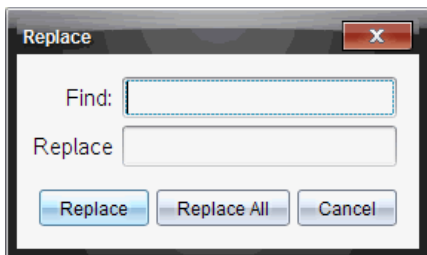

2. Type the text that you want to find.
3. Type the replacement text.
4. Click **Replace** to replace the first occurrence after the cursor position.

–or–

Click **Replace All** to replace every occurrence.

Note: If the text is found in a math template, a message is displayed to warn you that your replacement text will replace the whole template—not just the found text.

Closing the Current Function or Program

- ▶ From the **Actions** menu, click **Close**.



If the function or program has unstored changes, you are prompted to check syntax and store before closing.

Running Programs and Evaluating Functions

After defining and storing a function or program, you can use it from an application. All the applications can evaluate functions, but only the Calculator and Notes applications can run programs.



The program statements are executed in sequential order (although some commands alter the program flow). The output, if any, is displayed in the application's work area.

- Program execution continues until it reaches the last statement or a **Stop** command.
- Function execution continues until it reaches a **Return** command.
- To stop a program or function manually,
 - Windows®: Hold down the **F12** key and press **Enter** repeatedly.

- Mac®: Hold down the **F5** key and press **Enter** repeatedly.
- Handheld: Hold down the  key and press  repeatedly.

Using Short and Long Names

Anytime you are in the same problem where an object is defined, you can access it by entering its short name (the name given in the object's **Define** command). This is the case for all defined objects, including private, public, and non-library objects.

You can access a library object from any document by typing the object's long name. A long name consists of the name of the object's library document followed by a backslash "\ " followed by the name of the object. For example, the long name of the object defined as **func1** in the library document **lib1** is **lib1\func1**. To type the "\ " character on the handheld, press  .

Note: If you cannot remember the exact name or the order of arguments required for a private library object, you can open the library document or use the Program Editor to view the object. You also can use **getVarInfo** to view a list of objects in a library.

Using a Public Library Function or Program

1. Make sure you have defined the object in the document's first problem, stored the object, saved the library document in the MyLib folder, and refreshed the libraries.
2. Open the TI-Nspire™ application in which you want to use the function or program.

Note: All applications can evaluate functions, but only the Calculator and Notes applications can run programs.

3. Open the Catalog and use the library tab to find and insert the object.
—or—

Type the name of the object. In the case of a function or program, always follow the name with parentheses.

```
lib2\func1()
```

4. If the program requires you to supply one or more arguments, type the values or variable names inside the parentheses.

```
lib2\func1(34,power)
```

5. Press .

Using a Private Library Function or Program

To use a Private library object, you must know its long name. For example, the long name of the object defined as **func1** in the library document **lib1** is **lib1\func1**.

Note: If you cannot remember the exact name or the order of arguments required for a private library object, you can open the library document or use the Program Editor to view the object.

1. Make sure you have defined the object in the document's first problem, stored the object, saved the library document in the MyLib folder, and refreshed the libraries.
2. Open the TI-Nspire™ application in which you want to use the function or program.

Note: All applications can evaluate functions, but only the Calculator and Notes applications can run programs.

3. Type the name of the object. In the case of a function or program, always follow the name with parentheses.

```
lib2\func1()
```

4. If the object requires you to supply one or more arguments, type the values or variable names inside the parentheses.

```
lib2\func1(34,power)
```

5. Press .

Running a Non-Library Program or Function

1. Make sure you are in the same problem in which the function or program is defined.
2. Type the name of the function or program on the entry line.

–or–

Press to select the name from a list.

You must always include a set of parentheses after the name.

```
prog1()
```

If the function or program requires you to supply one or more arguments, type the values or variable names inside the parentheses.

```
prog1(34,power)
```

3. Press **enter**.

Interrupting a Running Program

While a function or program is running, the busy pointer  is displayed.

- ▶ To stop the function or program,
 - Windows®: Hold down the **F12** key and press **Enter** repeatedly.
 - Mac®: Hold down the **F5** key and press **Enter** repeatedly.
 - Handheld: Hold down the **on** key and press **enter** repeatedly.

A message is displayed. To edit the function or program in the Program Editor, select **Go To**. The cursor appears at the command where the break occurred.

Getting Values into a Program

You can choose from several methods to supply the values that a function or program uses in calculations.

Embedding the Values Within the Program or Function

This method is useful primarily for values that must be the same each time the program or function is used.

1. Define the program.

```
Define calculatearea()=  
Prgm  
w:=3  
h:=23.64  
area:=w*h  
EndPrgm
```

2. Run the program.

```
calculatearea()  
:area          70.92
```

Letting the User Assign the Values to Variables

A program or function can refer to variables created beforehand. This method requires users to remember the variable names and to assign values to them before using the object.

1. Define the program.

```
Define calculatearea()=  
Prgm  
area:=w*h  
EndPrgm
```

2. Supply the variables, and then run the program.

```
w:=3 : h:=23.64  
calculatearea()  
:area                70.92
```

Letting the User Supply the Values as Arguments

This method lets users pass one or more values as arguments within the expression that calls the program or function.

The following program, **volcyl**, calculates the volume of a cylinder. It requires the user to supply two values: height and radius of the cylinder.

1. Define the **volcyl** program.

```
Definevolcyl(height,radius) =  
Prgm  
Disp "Volume =", approx( $\pi$  • radius2 •  
height)  
EndPrgm
```

2. Run the program to display the volume of a cylinder with a height of 34 mm and a radius of 5 mm.

```
volcyl(34,5)          Volume = 534.071
```

Note: You do not have to use the parameter names when you run the **volcyl** program, but you must supply two arguments (as values, variables, or expressions). The first must represent the height, and the second must represent the radius.

Requesting the Values from the User (Programs Only)

You can use the **Request** and **RequestStr** commands in a program to make the program pause and display a dialog box prompting the user for information. This method does not require users to remember variable names or the order in which they are needed.

You cannot use the **Request** or **RequestStr** command in a function.

1. Define the program.

```
Define calculatearea()=  
Prgm  
  Request "Width: ",w  
  Request "Height: ",h  
  area:=w*h  
EndPrgm
```

2. Run the program and respond to the requests.

```
calculatearea() : area  
Width: 3      (3 entered as a response)  
Height: 23.64 (23.64 entered as a  
response)  
  
70.92
```

Use **RequestStr** instead of **Request** when you want the program to interpret the user's response as a character string rather than a math expression. This avoids requiring the user to enclose the response in quotation marks ("").

Displaying Information from a Function or Program

A running function or program does not display intermediate calculated results unless you include a command to display them. This is an important difference between performing a calculation on the entry line and performing it in a function or program.

The following calculations, for example, do not display a result in a function or program (although they do from the entry line).

```
∴  
x:=12•6
```

```
cos( $\pi/4$ )
⋮
```

Displaying Information in the History

You can use the **Disp** command in a program or function to display information, including intermediate results, in the history.

```
⋮
Disp 12•6
Disp "Result:",cos( $\pi/4$ )
⋮
```

Displaying Information in a Dialog Box

You can use the **Text** command to pause a running program and display information in a dialog box. The user clicks **OK** to continue or clicks **Cancel** to stop the program.

You cannot use the **Text** command in a function.

```
⋮
Text "Area=" & area
⋮
```

Note: Displaying a result with **Disp** or **Text** does not store that result. If you expect to refer later to a result, store it to a global variable.

```
⋮
cos( $\pi/4$ )→maximum
Disp maximum
⋮
```

Using Local Variables

A local variable is a temporary variable that exists only while a user-defined function is being evaluated or a user-defined program is running.

Example of a Local Variable

The following program segment shows a **For...EndFor** loop (which is discussed later in this module). The variable i is the loop counter. In most cases, the variable i is used only while the program is running.

```
Local i ❶  
For i,0,5,1  
  Disp i  
EndFor  
Disp i
```

❶ Declares variable *i* as local.

Note: When possible, declare as local any variable that is used only within the program and does not need to be available after the program stops.

What Causes an Undefined Variable Error Message?

An **Undefined** variable error message is displayed when you evaluate a user-defined function or run a user-defined program that references a local variable that is not initialized (assigned a value).

For example:

```
Define fact(n)=Func  
  Local m ❶  
  While n>1  
    n•m→m: n-1→n  
  EndWhile  
  Return m  
EndFunc
```

❶ Local variable *m* is not assigned an initial value.

Initialize Local Variables

All local variables must be assigned an initial value before they are referenced.

```
Define fact(n)=Func  
  Local m: 1→m ❶  
  While n>1  
    n•m→m: n-1→n  
  EndWhile  
  Return m  
EndFunc
```

❶ 1 is stored as the initial value for *m*.

Note (CAS): Functions and programs cannot use a local variable to perform symbolic calculations.

CAS: Performing Symbolic Calculations

If you want a function or program to perform symbolic calculations, you must use a global variable instead of a local. However, you must be certain that the global variable does not already exist outside of the program. The following methods can help.

- Refer to a global variable name, typically with two or more characters, that is not likely to exist outside of the function or program.
- Include **DelVar** within a program to delete the global variable, if it exists, before referring to it. (**DelVar** does not delete locked or linked variables.)

Differences Between Functions and Programs

A function defined in the Program Editor is similar to the functions built into the TI-Nspire™ Software.

- Functions must return a result, which can be graphed or entered in a table. Programs do not return a result.
- You can use a function (but not a program) within an expression. For example: $3 \cdot \text{func1}(3)$ is valid, but not $3 \cdot \text{prog1}(3)$.
- You can run programs from Calculator and Notes applications only. However, you can evaluate functions in Calculator, Notes, Lists & Spreadsheet, Graphs & Geometry, and Data & Statistics.
- A function can refer to any variable; however, it can store a value to a local variable only. Programs can store to local and global variables.

Note: Arguments used to pass values to a function are treated as local variables automatically. If you want to store to any other variables, you must declare them as **Local** from within the function.

- A function cannot call a program as a subroutine, but it can call another user-defined function.
- You cannot define a program within a function.
- A function cannot define a global function, but it can define a local function.

Calling One Program from Another

One program can call another program as a subroutine. The subroutine can be external (a separate program) or internal (included in the main program). Subroutines are useful when a program needs to repeat the same group of commands at several different places.

Calling a Separate Program

To call a separate program, use the same syntax that you use to run the program from the entry line.

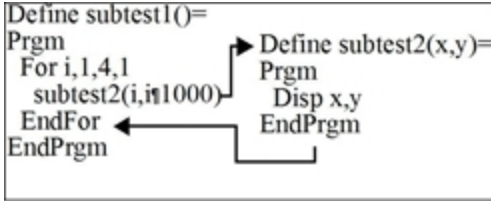

Defining and Calling an Internal Subroutine

To define an internal subroutine, use the **Define** command with **Prgm...EndPrgm**. Because a subroutine must be defined before it can be called, it is a good practice to define subroutines at the beginning of the main program.

An internal subroutine is called and executed in the same way as a separate program.

```
Define subtest1()=  
  Prgm  
  local subtest2 ①  
  Define subtest2(x,y)= ②  
  Prgm  
  Disp x,y  
  EndPrgm  
  ©Beginning of main program  
  For i,1,4,1  
  subtest2(i,i*1000) ③  
  EndFor  
  EndPrgm
```

- 1 Declares the subroutine as a local variable.
- 2 Defines the subroutine.
- 3 Calls the subroutine.

Note: Use the Program Editor's **Var** menu to enter the **Define** and **Prgm...EndPrgm** commands.

Notes about Using Subroutines

At the end of a subroutine, execution returns to the calling program. To exit a subroutine at any other time, use **Return** with no argument.

A subroutine cannot access local variables declared in the calling program. Likewise, the calling program cannot access local variables declared in a subroutine.

Lbl commands are local to the programs in which they are located. Therefore, a **Goto** command in the calling program cannot branch to a label in a subroutine or vice versa.

Avoiding Circular-Definition Errors

When evaluating a user-defined function or running a program, you can specify an argument that includes the same variable that was used to define the function or create the program. However, to avoid circular-definition errors, you must assign a value for variables that are used in evaluating the function or running the program. For example:

$x+1 \rightarrow x$ ❶

- or -

For i,i,10,1
Disp i ❶
EndFor

- ❶ Causes a **Circular definition** error message if x or i does not have a value. The error does not occur if x or i has already been assigned a value.

Controlling the Flow of a Function or Program

When you run a program or evaluate a function, the program lines are executed in sequential order. However, some commands alter the program flow. For example:

- Control structures such as **If...EndIf** commands use a conditional test to decide which part of a program to execute.
- Loop commands such as **For...EndFor** repeat a group of commands.

Using If, Lbl, and Goto to Control Program Flow

The **If** command and several **If...EndIf** structures let you execute a statement or block of statements conditionally, that is, based on the result of a test (such as $x > 5$). **Lbl** (label) and **Goto** commands let you branch, or jump, from one place to another in a function or program.

The **If** command and several **If...EndIf** structures reside on the Program Editor's **Control** menu.

When you insert a structure such as **If...Then...EndIf**, a template is inserted at the cursor location. The cursor is positioned so that you can enter a conditional test.

If Command

To execute a single command when a conditional test is true, use the general form:

```
If x>5
  Disp "x is greater than 5" ❶
Disp x ❷
```

❶ Executed only if $x > 5$; otherwise, skipped.

❷ Always displays the value of x .

In this example, you must store a value to x before executing the **If** command.

If...Then...EndIf Structures

To execute one group of commands if a conditional test is true, use the structure:

```
If x>5 Then
  Disp "x is greater than 5" ❶
  2•x→x ❶
EndIf
Disp x ❷
```

❶ Executed only if $x > 5$.

② Displays the value of:

2x if $x > 5$

x if $x \leq 5$

Note: **EndIf** marks the end of the **Then** block that is executed if the condition is true.

If...Then...Else...EndIf Structures

To execute one group of commands if a conditional test is true and a different group if the condition is false, use this structure:

```
If x>5 Then
  Disp "x is greater than 5" ①
  2•x→x ①
Else
  Disp "x is less than or equal to 5" ②
  5•x→x ②
EndIf
Disp x ③
```

① Executed only if $x > 5$.

② Executed only if $x \leq 5$.

③ Displays value of:

2x if $x > 5$

5x if $x \leq 5$

If...Then...Elseif... EndIf Structures

A more complex form of the **If** command lets you test for multiple conditions. Suppose you want a program to test a user-supplied argument that signifies one of four options.

To test for each option (If Choice=1, If Choice=2, and so on), use the **If...Then...Elseif...EndIf** structure.

Lbl and Goto Commands

You can also control the flow by using **Lbl** (label) and **Goto** commands. These commands reside on the Program Editor's **Transfers** menu.

Use the **Lbl** command to label (assign a name to) a particular location in the function or program.

Lbl <i>labelName</i>	name to assign to this location (use the same naming convention as a variable name)
-----------------------------	---

You can then use the **Goto** command at any point in the function or program to branch to the location that corresponds to the specified label.

Goto <i>labelName</i>	specifies which Lbl command to branch to
------------------------------	---

Because a **Goto** command is unconditional (it always branches to the specified label), it is often used with an **If** command so that you can specify a conditional test. For example:

```
If x>5
  Goto GT5 ❶
Disp x
-----
----- ❷
Lbl GT5
Disp "The number was > 5"
```

- ❶ If $x > 5$, branches directly to label GT5.
- ❷ For this example, the program must include commands (such as **Stop**) that prevent **Lbl** GT5 from being executed if $x \leq 5$.

Using Loops to Repeat a Group of Commands

To repeat the same group of commands successively, use one of the loop structures. Several types of loops are available. Each type gives you a different way to exit the loop, based on a conditional test.

Loop and loop-related commands reside on the Program Editor's **Control** and **Transfers** menus.

When you insert one of the loop structures, its template is inserted at the cursor location. You can then begin entering the commands that will be executed within the loop.

For...EndFor Loops

A **For...EndFor** loop uses a counter to control the number of times the loop is repeated. The syntax of the **For** command is:

For *variable*, *begin*, *end*, *increment*

- ① ② ③ ④

- ① Name of a variable to be used as a counter
- ② Value assigned to *variable* when the **For** loop begins.
- ③ Value compared to the current value of *variable* at each iteration of the loop. The loop exits when *variable* exceeds *end*.
- ④ Value added to *variable* at each iteration of the loop (This argument is optional. The default *increment* is 1.)

At each iteration of the **For** loop, the *variable* value is compared to the *end* value. If *variable* does not exceed *end*, the commands within the **For...EndFor** loop are executed and the loop repeats; otherwise, control jumps to the command following **EndFor**.

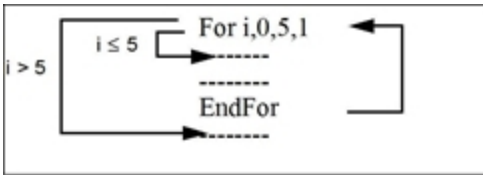

Note: The **For** command automatically increments the counter variable so that the function or program can exit the loop after a certain number of repetitions.

At the end of the loop (**EndFor**), control loops back to the **For** command, where the counter variable is incremented and compared to *end*.

For example:

```
For i,0,5,1
  Disp i ①
EndFor
Disp i ②
```

- ① Displays 0, 1, 2, 3, 4, and 5.
- ② Displays 6. When *variable* increments to 6, the loop is not executed.

Notes:

- You can declare *variable* as local if it does not need to be saved after the function or program stops.

- You can set *end* to a value less than *begin*, provided you also set *increment* to a negative value.

While...EndWhile Loops

A **While...EndWhile** loop repeats a block of commands as long as a specified condition is true. The syntax of the **While** command is:

While *condition*

When **While** is executed, *condition* is evaluated. If *condition* is true, the loop is executed; otherwise, control jumps to the command following **EndWhile**.

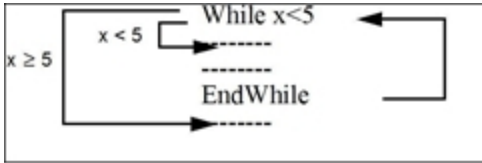

Note: The **While** command does not automatically change the condition. You must include commands that allow the function or program to exit the loop.

At the end of the loop (**EndWhile**), control jumps back to the **While** command, where condition is re-evaluated.

To execute the loop the first time, the condition must initially be true.

- Any variables referenced in the condition must be set before the **While** command. (You can build the values into the function or program, or you can prompt the user to enter the values.)
- The loop must contain commands that change the values in the condition, eventually causing it to be false. Otherwise, the condition is always true and the function or program cannot exit the loop (called an infinite loop).

For example:

```

0→x ①
While x<5
  Disp x ②
  x+1→x ③
EndWhile
Disp x ④
  
```

- ① Initially sets x.
- ② Displays 0, 1, 2, 3, and 4.

- ③ Increments x .
- ④ Displays 5. When x increments to 5, the loop is not executed.

Loop...EndLoop Loops

A **Loop...EndLoop** creates an infinite loop, which is repeated endlessly. The **Loop** command does not have any arguments.

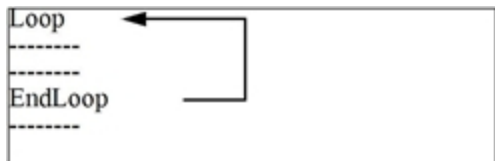

Typically, you insert commands in the loop that let the program exit from the loop. Commonly used commands are: **If**, **Exit**, **Goto**, and **Lbl** (label). For example:

```

0→x
Loop
  Disp x
  x+1→x
  If x>5 ①
  Exit
EndLoop
Disp x ②

```

- ① An **If** command checks the condition.
- ② Exits the loop and jumps to here when x increments to 6.

Note: The **Exit** command exits from the current loop.

In this example, the **If** command can be anywhere in the loop.

When the If command is:	The loop is:
At the beginning of the loop	Executed only if the condition is true.
At the end of the loop	Executed at least once and repeated only if the condition is true.

The **If** command could also use a **Goto** command to transfer program control to a specified **Lbl** (label) command.

Repeating a Loop Immediately

The **Cycle** command immediately transfers program control to the next iteration of a loop (before the current iteration is complete). This command works with **For...EndFor**, **While...EndWhile**, and **Loop...EndLoop**.

Lbl and Goto Loops

Although the **Lbl** (label) and **Goto** commands are not strictly loop commands, they can be used to create an infinite loop. For example:

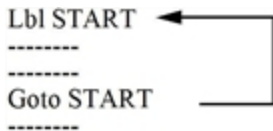

As with **Loop...EndLoop**, the loop should contain commands that let the function or program exit from the loop.

Changing Mode Settings

Functions and programs can use the **setMode()** function to temporarily set specific calculation or result modes. The Program Editor's **Mode** menu makes it easy to enter the correct syntax without requiring you to memorize numeric codes.

Note: Mode changes made within a function or program definition do not persist outside the function or program.

Setting a Mode

1. Position the cursor where you want to insert the **setMode** function.
2. From the **Mode** menu, click the mode to change, and click the new setting.

The correct syntax is inserted at the cursor location. For example:

```
setMode(1,3)
```

Debugging Programs and Handling Errors

After you write a function or program, you can use several techniques to find and correct errors. You can also build an error-handling command into the function or program itself.

If your function or program allows the user to select from several options, be sure to run it and test each option.

Techniques for Debugging

Run-time error messages can locate syntax errors but not errors in program logic. The following techniques may be useful.

- Temporarily insert **Disp** commands to display the values of critical variables.
- To confirm that a loop is executed the correct number of times, use **Disp** to display the counter variable or the values in the conditional test.
- To confirm that a subroutine is executed, use **Disp** to display messages such as “Entering subroutine” and “Exiting subroutine” at the beginning and end of the subroutine.
- To stop a program or function manually,
 - Windows®: Hold down the **F12** key and press **Enter** repeatedly.
 - Mac®: Hold down the **F5** key and press **Enter** repeatedly.
 - Handheld: Hold down the **on** key and press **enter** repeatedly.

Error-handling Commands

Command	Description
Try...EndTry	Defines a block that lets a function or program execute a command and, if necessary, recover from an error generated by that command.
ClrErr	Clears the error status and sets system variable <code>errCode</code> to zero. For an example of using <code>errCode</code> , see the Try command in the <i>Reference Guide</i> .
PassErr	Passes an error to the next level of the Try...EndTry block.

Using the TI-SmartView™ Emulator

With three layout options to choose from, teachers will find that the emulator facilitates classroom presentations. In the teacher software, layout options are:

- Handheld only
- Keypad plus side screen
- Handheld plus side screen

In the student software, the TI-SmartView™ emulates the keypad, which along with the handheld view, gives students the ability to drive the software as if using a handheld.

Opening the TI-SmartView™ Emulator

The TI-SmartView™ emulator is located in the Documents Workspace. To open the emulator view:

1. Open the Documents Workspace.
2. Click , which is located in the Documents Toolbox.

In the teacher software, the handheld is displayed with Handheld and SideScreen panels open in computer mode as shown in the following illustration. You can use the keypad on the emulated handheld, but the document won't appear on the emulated handheld screen until you switch to Handheld mode.

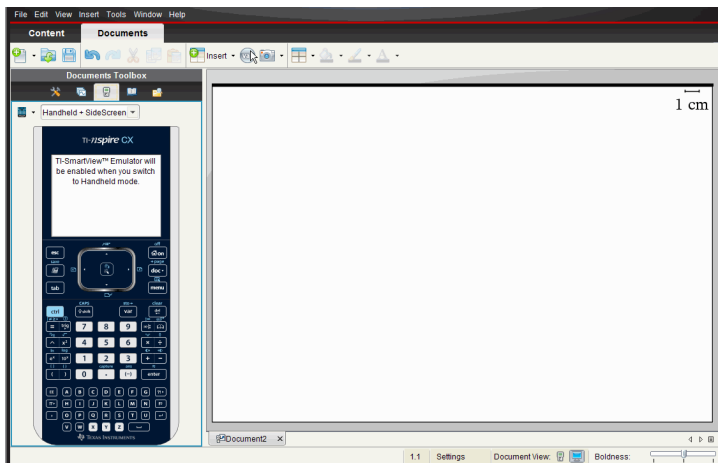

In the student software, the TI-Nspire™ CX keypad is displayed with the side screen open in computer mode. You can use the keypad on the emulated handheld to work with the document in the side screen in either computer mode or handheld mode.

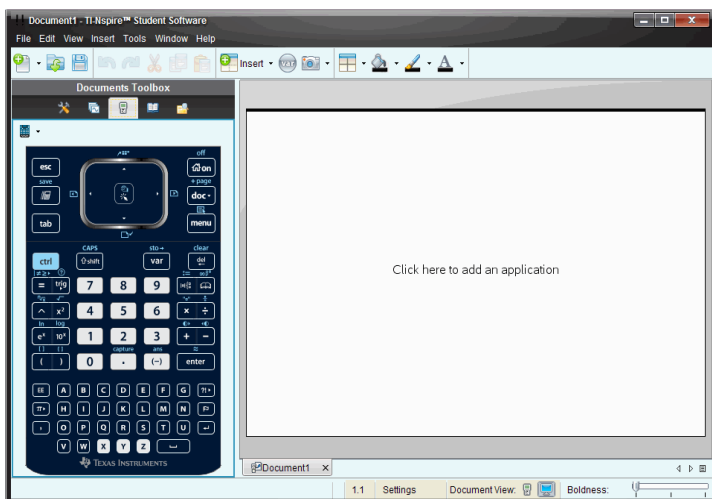

3. Click **View > Handheld**.

—or—

Click  in the status bar to switch to handheld mode.

Choosing a Keypad

An open document is not affected by changing the keypad. You can switch between keypads anytime you want. To select a keypad:

1. In the emulator panel, click  to open the menu and select one of the following options:
 - TI-Nspire™ CX
 - TI-Nspire™ with Touchpad
 - TI-Nspire™ with Clickpad
2. Click ► to select a faceplate option:
 - Normal
 - High Contrast
 - Outline

Choosing Display Options

In the teacher software, use this option to choose how to display the emulator in the software window.

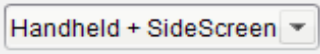
1. In the emulator panel, click .
–or–
Click **File > Settings > TI-SmartView™**.
2. Select one of the following options:
 - **Handheld Only.** Displays the emulated handheld and hides the workspace and other panels.
Note: To keep the Handheld Only display in front of other application windows, click **Always in Front** at the top right of the TI-SmartView™ panel.
 - **Keypad + SideScreen.** Opens a larger view of the keypad along with the side screen.
 - **Handheld + SideScreen.** Opens the entire emulated handheld along with the side screen.

Changing the Width of the TI-SmartView™ Panel

To change the width of the TI-SmartView™ emulator panel:

- ▶ Click the right edge of the panel and drag it until it is the width you want.

Changing the Size of the Screen in the Workspace

When in handheld mode, use the Scale to change the size of the screen.

- ▶ Drag the slider to the appropriate scale percentage. The scale slider is located on the far right side of the status bar, at the bottom of the TI-Nspire™ window. Scale percentages range from 100% to 200%. The default scale is 150%.



Note: If computer mode is selected, you cannot change the size of the workspace.

Working with the Emulated Handheld

To input data and work with files on the emulator, you can use the computer keyboard, TI-SmartView™ keypad, TI-Nspire™ menus and icons, or any combination of these.

Note: Within one command, you cannot use a combination of both the keypad and the keyboard. For example, you cannot press **Ctrl** on the keyboard and click  on the emulator to open a context menu.

For the most part, you can perform any function in the TI-SmartView™ emulator that you can perform on the handheld. Keys and applications operate the same way.

Note: If you switch to Computer mode, you can still use most of the keys on the emulated handheld or keypad and all keystrokes are reflected in the workspace. However, some key combinations may only work in Handheld mode.

As you click keys on the emulator or press keys on the keyboard that activate keys on the emulator, those keys change color, making it easy for your audience to follow along. The last key selected stays highlighted.

In the teacher software, the emulator screen and the side screen are both interactive. You can click on icons and menu items on both screens. You can also right-click to display menus on both screens.

All handheld shortcuts and arrow functionality work from the computer keyboard. For example, to save a document, you can click **ctrl** **S** on the emulator keypad or you can press **Ctrl + S** on the computer keyboard. When using a Mac®, press **⌘ + S**.

Using the Touchpad

You can operate the Touchpad on the TI-Nspire™ Touchpad keypad using either the touchpad on a laptop or by using the mouse to click the Touchpad. Areas of the Touchpad are highlighted as you click the arrow zones.



An arrow is highlighted when you press or tap it.

- Clicking the **◀**, **▶**, **▲**, or **▼** keys on the Touchpad moves through menus one item at a time.
- Clicking and holding down an arrow on the Touchpad causes continual movement in the selected direction.
- Clicking and sliding the mouse across the Touchpad area enables you to move the mouse pointer.
- Clicking the middle of the Touchpad selects the highlighted menu option.

Using the Clickpad

You can use the Clickpad on the TI-Nspire™ Clickpad keypad using either the touchpad on a laptop or by using the mouse to click the Clickpad. Areas of the Clickpad are highlighted as you click the arrow zones.



- Clicking the ◀, ▶, ▲, or ▼ keys on the Clickpad moves through menus one item at a time.
- Clicking and holding down an arrow on the Clickpad causes continual movement in the selected direction.
- Clicking the middle of the Clickpad selects the highlighted menu option.

Using Settings and Status

When working with the TI-SmartView™ emulator, you can change General Settings and Document Settings. For more information, see *Using the Documents Workspace*.

You can view all other settings, but you cannot change them in the TI-SmartView™ emulator. However, the ability to view these options provides teachers with an instructional tool when they need to show students how to set up a handheld.

To view settings and status:

1. Click  to access the Home screen.
2. Click **Settings**.

Setting or Settings	Description
Language	You can open the languages menu and select a language, but you cannot save changes. To change the language, use the TI-Nspire™ menu File > Settings > Change Language option.
Handheld Setup	You can open the menus and select items to demonstrate which items to choose, but you cannot save any changes.
Handheld Status	You can access the screen. The # symbol replaces any numeric values that would be displayed on the handheld.

Setting or Settings	Description
About	You can open the About screen and view the software version. Other information that pertains only to the handheld hardware is marked as "Not Applicable."
Login	You can display the Login to Class screen and type in the User Name and Password fields. Login is not available.

Changing TI-SmartView™ Options

You can change the emulator options, even when the emulator panel is closed.

1. In the teacher software, click **File > Settings > TI-SmartView™ Options**.

The TI-SmartView™ Options dialog box opens.

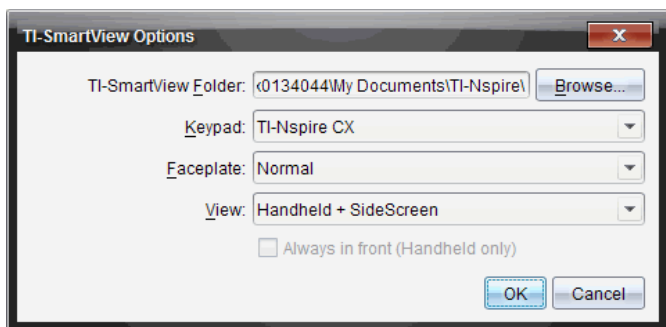

In the student software, click **File > Settings > Keypad Options**.

The Keypad Options dialog box opens.

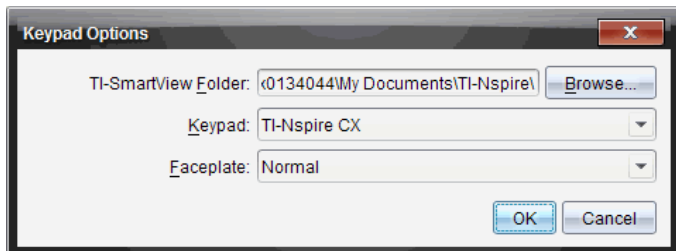

2. Click **Browse** to change the folder where documents are saved and accessed in the My Documents folder when using the emulator.

Important: If you change the TI-SmartView™ location, you must also copy or move the MyLib folder and paste it to the new location to see library objects.

The default location of MyLib is:

- Windows®: Documents\TI-Nspire\MyLib.
- Mac®: Documents/TI-Nspire/MyLib.

Note: Close and reopen the TI-Nspire™ application for the libraries to reflect the change.

3. Click ▼ to open the menu and select a keypad.
4. Click ▼ to open the menu and select a faceplate.
5. In the teacher software, click ▼ to open the menu and select a view. If selecting Handheld only, select **Always in Front** to keep this window on top of all other open applications.
6. Click **OK** to save the settings.

Working with Documents

You can open multiple documents in the workspace by selecting **File > Open Document** from the menu or using keyboard shortcuts. When you switch between these documents, the emulated handheld shows only the current document. You can insert pages and problems using either the TI-Nspire™ menus or icons, keyboard shortcuts, or TI-SmartView™ menus or shortcuts.

Note: You cannot work with PublishView™ documents using the TI-SmartView™ emulator. When you create or open a PublishView™ document, the document opens in Computer mode.

Opening a Document

You can open a document by navigating to it on the emulator, the same way you open a document on the handheld, or you click **File > Open Document**.

When you open a document using the emulator, you can only open documents that are in the folder displayed on the emulator (usually the My Documents folder, unless you specified a different folder in your TI-SmartView™ settings). When you open a document using the menu path, you can browse to find any

TI-Nspire™ document on your computer or network. If you open a document using the emulated handheld, it replaces the document that was previously open.

Note: If the number of characters in the document's file path name exceeds 256 characters, the document cannot be opened and an error message is displayed. To avoid this error, keep file and folder names short or move files up in the file path.

Saving a Document

When you save a document using the **File > Save Document** menu or icon, keyboard shortcuts, keypad shortcuts, or emulator menus, the document is saved in the same location where the file was opened. To save the file in another location or with a different name, click **File > Save As**.

Using Screen Capture

To capture the current page, press **Ctrl + J** (Mac®: **⌘ + J**) on your keyboard or on the emulated handheld. The image is automatically placed in the Clipboard and in the TI-Nspire™ Screen Capture window. You can paste the image into another application without having to take additional steps. This feature is only available when the TI-SmartView™ panel is active and the workspace is in Handheld mode.

All other screen capture features work the same way they do in other areas of TI-Nspire™ software. For more information, see *Capturing Screens*.

Writing Lua Scripts

The Script Editor allows you to create and deliver dynamically linked simulations, powerful and flexible utilities, and other educational content for exploring math and science concepts. When you open a document containing a script, the script runs automatically as programmed. To see the running script application, the page containing the script application must be active.

The Script Editor is directed toward teachers and other authors who are comfortable working in a Lua scripting environment. Lua is a powerful, fast, lightweight scripting language that is fully supported in TI-Nspire™ and PublishView™ documents. Documents containing script applications can be opened on TI-Nspire™ handhelds and in the TI-Nspire™ Document Player. The script application runs on a handheld or in Document Player, but you cannot view or edit the script.

Note these resources for using the Script Editor and creating scripts:

- Press **F1** to access the TI-Nspire™ help, which includes the Script Editor help.
- Press **F2** for additional TI-Nspire™ resources such as scripting samples and a link to the TI-Nspire™ Scripting API library. (This information is also available at education.ti.com/nspire/scripting.)
- Go to lua.org for more information about Lua.

Overview of the Script Editor

With the Script Editor, you can insert, edit, save, run, and debug script applications in TI-Nspire™ (.tns files) and Publishview™ (.tnsp files) documents.

- Script applications function within documents, problems, and pages the same way that other TI-Nspire™ applications do.
- When you create a new document or open an existing document, you can insert or edit a script application within a page or within a work area of a split page.
- In a split page layout, you can add a script application to each work area of a page. A page can be split into a maximum of four quadrants.
- Images can be added to script applications. See the *Inserting Images* section.

- All work done in the Script Editor is lost if you close the TI-Nspire™ or PublishView™ document without saving it.

Exploring the Script Editor Interface

The Script Editor window opens when you insert a new script application or edit an existing script application in a TI-Nspire™ or PublishView™ document.

Select options for creating new scripts or editing scripts from the Insert menu in the Documents Workspace when a document is open.

Note: Although not labeled, the Documents Workspace is the default workspace in the TI-Nspire™ Student Software and TI-Nspire™ CAS Student Software.

The following figure shows the Script Editor with an existing script.

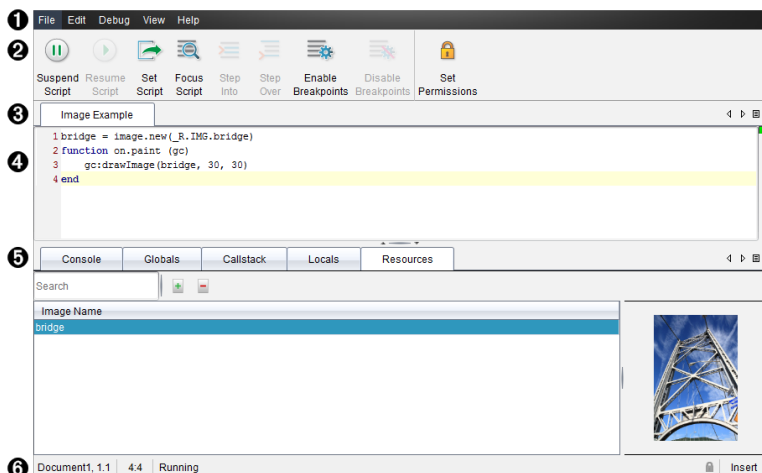









- 1 Menu bar.** Contains options for working with the Script Editor.
- 2 Toolbar.** Provides tools for common Script Editor functions. See the *Using the Toolbar* section.
- 3 Script title.** Shows script title. Right-click the title to change it or by clicking **Edit > Set Script Title**.
- 4 Text box.** Provides a space to type script text.
- 5 Tools panel.** Shows script data. See the *Using the Tools Panel* section.

- ⑥ **Status bar.** Displays the operational state of the script. See the *Using the Status Bar* section.

Using the Toolbar

The following table describes the toolbar options.

Tool name		Tool function
	Suspend Script	Pauses the script execution.
	Resume Script	Resumes the script execution. While debugging, the script continues to execute until the next breakpoint or the end of the script.
	Set Script	Starts the script execution.
	Focus Script	Sets the focus to the page in the document where the script application is attached: <ul style="list-style-type: none">• In a TI-Nspire™ document, sets the focus to the page.• In a PublishView™ document, sets the focus to the frame on the page.
	Step Into	While debugging, executes the current statement. If the statement calls any functions, the debugger stops at the first line of each function.
	Step Over	While debugging, executes the current statement. If the statement calls any functions, the debugger does not stop within the function unless the function contains a breakpoint.
	Enable Breakpoints	Switches from normal mode to debugging mode.

Tool name		Tool function
	Disable Breakpoints	Switches back from debugging mode to normal mode and resumes the script.
	Set Permissions	Sets permission levels to Protected, View Only, or Unprotected and allows you to set a password for the script.

Using the Tools Panel

At the bottom of the window, the Tools panel shows the scripting data. For more information, see the *Debugging Scripts* section.

Tab	Window Display
Console	Script errors are printed here. Print statements embedded in the script also print here.
Globals	Selected global variables are displayed. To select a global variable for display, select Click to add new watch variable at the bottom of the Tools panel.
Call Stack	Displays the call tree for the currently executing function.
Locals	Local variables in the current function's scope are displayed.
Resources	Upload, insert, and manage images here.

Using the Status Bar

The status bar at the bottom of the window shows basic script data, as described in this example: `stopwatch, 1.1, 4:1, Running`.

- Name of the document that the script application is attached to (`stopwatch`)
- Problem and page number (`1.1`)
- Script line and character, (`4:1` describing line 4 and character 1)
- Operational state of the script (`Running`). Note the possible states:
 - Normal mode: Running, Paused, or Error

- Debugging mode: Running (debugging), Paused, or Error

Inserting New Scripts

To insert a new script application and script, follow these steps.

1. Open the document where you want to insert the script. It can be a new or existing document.
2. Click **Insert > Script Editor > Insert Script**.

A script application is inserted, and the Script Title dialog box opens.

Note: The TI-Nspire™ Student Software and the TI-Nspire™ CAS Student Software open automatically within the Documents Workspace.

3. Type a script title. (The maximum number of characters is 32.)
4. Click **OK**.

The Script Editor window opens showing a blank script.

5. Type your text in the script lines.

Note: Some nonstandard UTF-8 wide characters may not be displayed correctly. For these characters, it is highly recommended that you use the `string.uchar` function.

6. When the script is complete, click **Set Script** to execute it.
 - In a TI-Nspire™ document, the script application is inserted in a new page. When the page containing the script application is active, the Documents Toolbox is empty.
 - In a PublishView™ document, a frame containing the script application is added to the active page. You can move or size this frame just as you would any other PublishView™ object, and you can add other PublishView™ objects to the page.
7. To view the script application, click **Focus Script**.

Editing Scripts

To edit an existing script, follow these steps.

1. Open the TI-Nspire™ or PublishView™ document that contains the script. The page containing the script must be active.
2. Select the page and the work area that contains the script.

3. Click **Insert > Script Editor > Edit Script**.

The Script Editor opens showing the script. If the selected work area on the page does not contain a script, Edit Script is dimmed.

If the script is password protected, the Password Protected dialog box opens prompting for a password.

4. Make any desired changes.

- To designate comments, use double hyphens (--) at the start of each comment line.
- To change the title, click **Edit > Set Script Title** or right-click the title and click **Set Script Title**.

Notes:

- Some nonstandard UTF-8 characters may not be displayed correctly. For these characters, it is highly recommended that you use the `string.uchar` function.
- The print function may yield unexpected results for non-UTF-8 characters.
- Some nonprintable characters returned by the `on.save` function will be discarded.

5. To execute the script, click **Set Script**.

Any errors are displayed in the Console area in the Tools panel.

6. To view the script application (running script), click **Focus Script**.

Changing View Options

To change viewing options:

- ▶ To clear the scripting data in the Tools panel and restore the editor defaults, click **View > Restore Editor to Defaults**.
- ▶ To view the script title in the document and before each print statement in the Console, click **View > Title in Document View**.
- ▶ To hide or show toolbar labels, click **View > Toolbar Text Labels**.
- ▶ To show or hide the Tools panel or its areas, click **View > Tools Panel** and click the appropriate option.
- ▶ To create tab groups when multiple scripts are open, right-click one of the titles and click **New Horizontal Group** or **New Vertical Group**.

Setting Minimum API Level

Each release of the T-Nspire™ software includes API support for a specific set of Lua scripting features. Setting the minimum API level for a script lets you specify a minimum set of features that you require for your script.

If a user tries to run the script on a system that does not meet the script's minimum API level, a message notifies the user and prevents the script from running.

To Set the Minimum API Level for a Script:

1. Determine the minimum level that you want your script to require.
 - Setting the level too low for the script's feature set can result in a script error on older software.
 - Setting the level too high can result in the script refusing to start on older software that supports the feature set.
2. On the Script Editor **File** menu, select **Set Minimum API Level**.
3. In the dialog box, type the minimum level using the format *major.minor*. For example, you might type 2.3.

This API level or higher will be required for running the script.

Saving Script Applications

Clicking Set Script resets (updates) a script application in a TI-Nspire™ or PublishView™ document. However, the script and script application are not saved until you save the document. If you close the document or close the TI-Nspire™ software without saving, work on the script is lost.

To ensure the script application is saved after all work is complete, follow these steps.

1. From the Script Editor window, click **Set Script** to reset (update) the script application in the document.
2. From an open document, click **File > Save Document** to save changes to the TI-Nspire™ or PublishView™ document.

Note: To ensure work is backed up, set the script and save the document frequently.

Managing Images

To insert an image into a script application, follow these steps.

Add an Image to Resources

1. Click the **Resource** tab.
2. Click the  button.
3. Click on an image file name.
4. Click **Open**.
5. Accept the default image name or rename the image by typing a new name into the box. (Ex: newimage)
6. Click **OK**.

Note: You will see the image thumbnail in the bottom-right corner of your screen. Your image file name will appear in a list of images at the bottom-left of your screen.

7. Right-click an image name to Rename, Copy Name, Preview, or Remove the image. You may also click the  button to remove an image.

Add Multiple Images to Resources

1. Click the **Resource** tab.
2. Click the  button.
3. Select **Comma Separated Values (*.csv)** from the **Files of Type** menu.
4. Select your **.csv** file.

Note: The .csv format consists of two comma-separated columns. The first column is the local name of the image resource used in the code. The second column is the absolute path to the image on the current system.

Example for Windows:

```
bridge,C:\images\bridge.jpg
```

```
house,C:\images\house.jpg
```

5. Click **Open**.
6. Right-click an image name to Rename, Copy Name, Preview, or Remove the image. You may also click the  button to remove an image.

Create a Script to Call Up an Image

1. Type a script in the script line box as follows:

```
myimage = image.new(_R.IMG.img_1)
function on.paint (gc)
    gc.drawImage (myimage, 30, 30)
end
```

Note: Replace `img_1` (above) with the name of your image.

2. Click **Set Script** to save the script. You will see your image in the Document Preview screen.
3. Click **Focus Script** to set the focus to the page in the document where you want to attach the script application.

Note: A TI-Nspire document sets the focus to the page; A PublishView™ document sets the focus to the frame on the page.

Create a Script to Call Up Multiple Images

1. Type a script in the script line box as follows:

```
myimg = { }
for name, data in pairs (_R.IMG)
    myimg [name] = image.new(data)
end
function on.paint (gc)
    gc.drawImage (myimg[imagename], 30, 30)
end
```

2. Click **Set Script** to save the script. You will see your image in the Document Preview screen.
3. Click **Focus Script** to set the focus to the page in the document where you want to attach the script application.

Note: A TI-Nspire document sets the focus to the page; A PublishView™ document sets the focus to the frame on the page.

Setting Script Permissions

You can set permission levels for a script and specify a password to protect a script. Follow these steps.

1. In the Script Editor window, click **File > Set Permissions**.
The Set Permissions dialog box opens.
2. In the Permissions Level area, select the appropriate security level:
 - **Protected**. The script can be run, but not viewed or edited.
 - **View only**. The script can be viewed, but not edited.
 - **Unprotected**. The script can be viewed and edited.
3. To secure a script, designate a password in the Security area.
Note: Use caution when setting passwords because they cannot be recovered.
4. Click **OK**.

The next time you click **Insert > Script Editor > Edit Script**, a Password Protected dialog box opens prompting for the password. Choose one of these options:

- To edit the script, enter the password and click **OK**.
- To view the script only, do not enter the password and click **View**.

Debugging Scripts

You can debug your script to investigate runtime errors and trace the execution flow. While debugging, data is displayed in the Tools panel.

- ▶ To enable debugging mode or disable it and return to normal mode, click **Debug > Enable Breakpoints** or **Disable Breakpoints**.
Note: Disabling breakpoints always resumes the script execution.
- ▶ While debugging, click **Step Into** and **Step Over** as appropriate. See the *Exploring the Script Editor interface* section.
- ▶ To set breakpoints, double-click in the space to the far left of the line number. Breakpoints are disabled until you click **EnableBreakpoints**.
- ▶ Note these factors when debugging:
 - Breakpoints in coroutines are not supported.

- If a breakpoint is set in a function that is a callback, the debugger may not stop at the breakpoint.
- The debugger may not stop at functions such as `on.save`, `on.restore`, and `on.destroy`.

On the toolbar, Step Into and Step Over are enabled when breakpoints are enabled.

- ▶ To suspend and resume the script execution, click **Suspend Script** and **Resume Script**. When the script resumes, it runs until the next breakpoint is encountered or to the end of the script. A script can be suspended in normal mode or debugging mode.

Using the Help Menu

Use the Help menu to find useful information to help you use the software more productively. You can:

- Open the PDF help file (press **F1** or click **Help**).
- Open the web-based help file (press **F2** or click **Online Help**).
- Activate your software license.
- Register your TI product.
- Explore TI resources such as Activities Exchange, where you can find lessons, quizzes, and other instructive activities shared by educators.
- Explore online troubleshooting or run TI-Nspire™ diagnostics.
- Check for updates to the software or updates to operating systems for TI-Nspire™ handhelds and the TI-Nspire™ Lab Cradle.
- Check to see which version of the software you are using.

Activating Your Software License

1. Ensure that your computer is connected to the Internet.
2. From the **Help** menu, select **Activate** to open the Texas Instruments Activation Wizard.
3. Click **Activate your License**, and then click **Next**.

The Complete Software Activation dialog box opens.

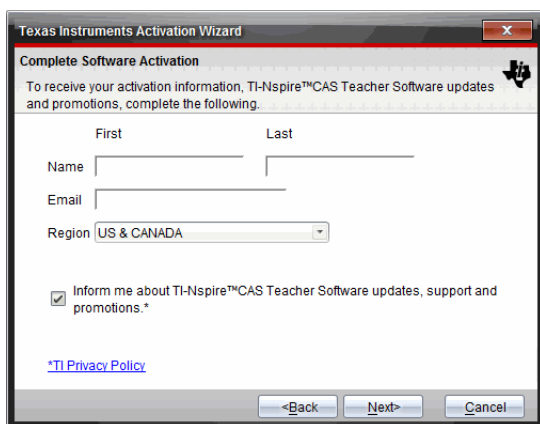

The screenshot shows a dialog box titled "Texas Instruments Activation Wizard" with a close button (X) in the top right corner. The main heading is "Complete Software Activation" with a Texas Instruments logo on the right. Below the heading is a paragraph: "To receive your activation information, TI-Nspire™CAS Teacher Software updates and promotions, complete the following." The form contains the following fields and controls:

- Two text input fields for "First" and "Last" name, with "Name" labeled to the left.
- A text input field for "Email".
- A dropdown menu for "Region" with "US & CANADA" selected.
- A checked checkbox with the text: "Inform me about TI-Nspire™CAS Teacher Software updates, support and promotions.*"
- A blue hyperlink labeled "[*TI Privacy Policy](#)".
- Three buttons at the bottom: "<Back", "Next>", and "Cancel".

- Complete the name and email fields, and then select the region where you live if different from the default entry. If you want to receive emails from TI about updates, support, and promotions, ensure the check box is selected.
- Click **Next**.

The Activate your software dialog box opens.

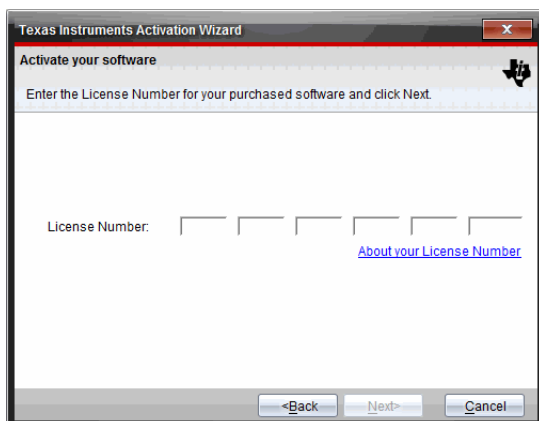

- Type the license number.
- Click **Next**.

The License Agreement dialog box opens.

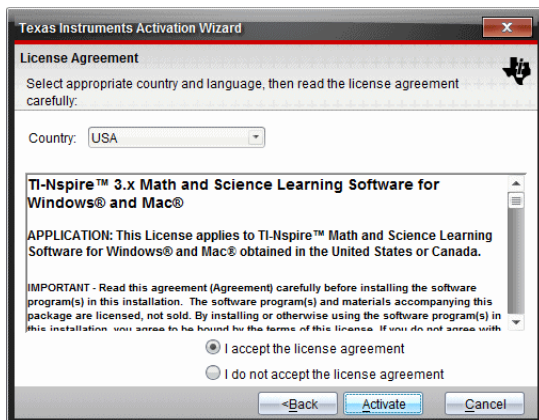

- In the Country field, select your country from the drop-down list if it is different from the default entry.

- Review the license agreement, and then select to accept the agreement.
- Click **Activate**. The license number is validated against the TI database to ensure it is valid.

If the license number is valid, the Successful Activation dialog box opens. If the license number is not valid, check to make sure the numbers are entered correctly. If the problem persists, contact TI Support.

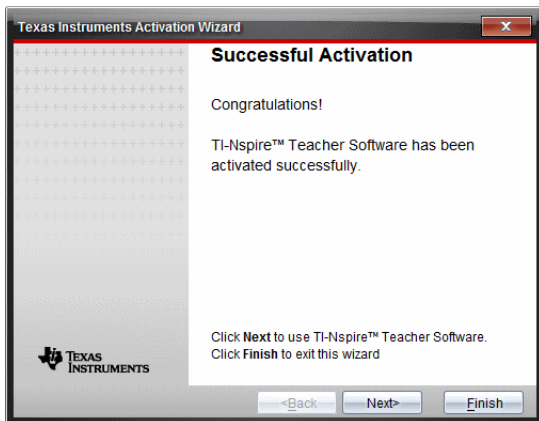

- Click **Next** to continue, or select **Finish** to complete the installation with default settings.
 - When prompted, click **OK** to accept the default location for your TI-Nspire™ folder. If needed, navigate to the location on your computer where you want to store your TI-Nspire™ documents and files.
 - Select whether or not to replace any documents that have the same name.
- The software launches and the **Welcome Screen** opens.

Registering Your Product

- Ensure that your computer is connected to the Internet.
- From the **Help** menu, select **Register** to access the TI Product Registration site.
- Follow the instructions on the website.

Downloading the Latest Guidebook

- Ensure that your computer is connected to the Internet.

2. From the **Help** menu, select **Download latest Guidebook**.
The Education Technology website opens with the Guidebooks tab active.
3. Click the title of the Guidebook that you want to download.
A PDF version of the Guidebook opens on your desktop.

Exploring TI Resources

The Help menu also provides links to TI resources and websites.

- ▶ Select **Help > Visit education.ti.com** to access the Texas Instruments Education Technology website.
- ▶ Select **Help > Visit Activities Exchange** to access the Texas Instruments Activities Exchange, site, a forum where you can browse by subject to find ready-to-use math and science learning activities appropriate for middle grades through college.
Note: Activities available for download may vary depending on your geographical region.
- ▶ Select **Help > Explore Online Troubleshooting** to access the TI Knowledge Base where you can find general information, troubleshooting help, product usage tips, and information specific to TI products.

Running TI-Nspire™ Diagnostics

If you have trouble with your software, this option enables you to run a short diagnostics program that will help TI support personnel troubleshoot the problem. You do not need Internet access to run diagnostics; however, Internet access is required to send the log file to TI Support. To run diagnostics:

1. From the **Help** menu, select **Run TI-Nspire™ Diagnostics**.
The Software Diagnostic Tool dialog box opens.

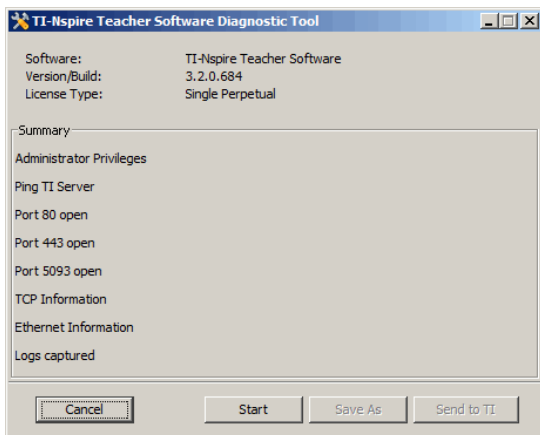

2. Click **Start** to run the program.
The log file is created and the Save as dialog box opens.
3. Navigate to the folder where you want to save the file, and then click **Save As**.
The Diagnostic Report dialog box opens providing the name of the zip file created and the location where it was saved.
4. Click **OK**.
5. From the Software Diagnostic Tool dialog box:
 - Click **Send to TI** to send the file to TI Support.
 - Click **Restart** to run the diagnostics program again.
 - Click **Cancel** to quit, and then click **OK** to confirm and close the dialog box.

Updating the TI-Nspire™ Software

Update the Software

1. Ensure that your computer is connected to the Internet.
2. Close any open documents.
3. From the **Help** menu, select **Check for Upgrades and Notifications**.
 - If your software is current, a confirmation message appears.
 - If your software is not current, you are prompted to update.

4. Click **Update** to download and install the update, or click **Close** to cancel.

A progress indicator shows the download progress. If you receive a connection error, check your Internet connection and try again.

Note for users updating TI-Nspire™ Navigator™ Teacher Software or TI-Nspire™ Navigator™ NC Teacher Software: Your portfolio and class records reside on your computer as a database. Because the new software might have features that are not supported in the old database structure, the old data might need to be converted. When conversion is necessary, a Database Update tool helps you make a backup of the old database. The tool appears during the first startup of the updated software.

Manage Automatic Checking

Automatic checking uses the Internet to check for upgrades each time you open the TI-Nspire™ software. If your system is not up-to-date, you receive a notification. You can turn automatic checking on or off.

1. From the **Help** menu, select **Check for Upgrades and Notifications**.
2. Check or clear the **Automatically check for updates** check box.
3. Click **Close**.

Updating the OS on a Connected Handheld

Note: To avoid losing unsaved data, close all documents on the handheld before updating its operating system.

1. Ensure that your computer is connected to the Internet.
2. In the Documents Toolbox, click the Content Explorer tab  to show connected handhelds.
3. Select the handheld that you are updating.
4. From the **Help** menu, select **Check for OS Updates**.
 - If the operating system is current, a confirmation message appears.

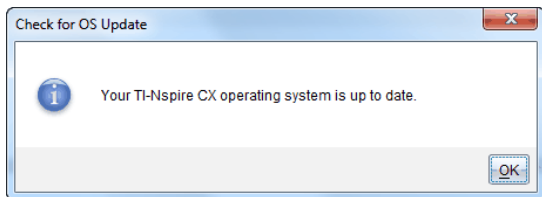

- If the operating system is not current, the TI-Nspire™ software prompts you to install the latest OS now. If the updated OS file is not already available on your computer, you can choose a location for it.

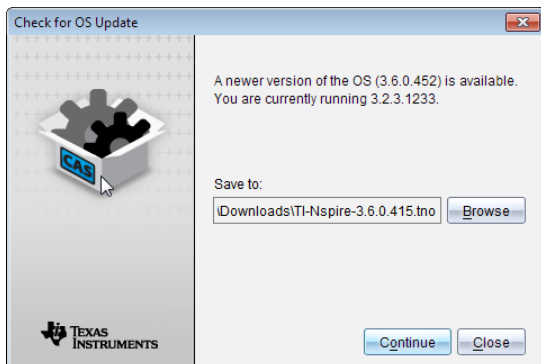

5. Click **Continue** and follow the prompts to install the OS on the handheld, or click **Close** to cancel.

When the update is complete, the handheld restarts automatically.

Viewing Software Version and Legal Information

1. From the Help menu, select **About TI-Nspire™ <Product Name> Software**.

Note: You do not need an Internet connection to open this screen.

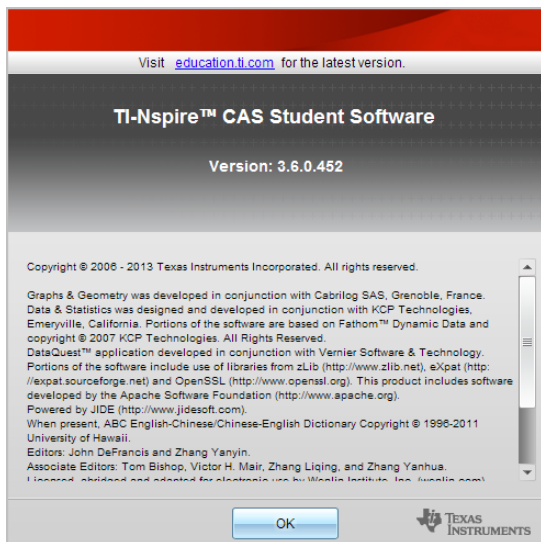

2. Click **OK** to close the window.

Helping Improve the Product

This product includes a feature that can help TI improve the product by automatically collecting anonymous information about product usage and reliability.

Note: Depending on how your software was installed, you might see the following screen the first time you start the software. You also can access the feature manually.

1. From the **Help** menu, select **Product Improvements**.
2. Read the information on the screen, and click one of the buttons:
 - To allow information to be collected, click **Yes, I want to help**.
 - To prevent collection, click **No thanks**.

Support and Service

Texas Instruments Support and Service

General Information: North and South America

Home Page:	education.ti.com
KnowledgeBase and e-mail inquiries:	education.ti.com/support
Phone:	(800) TI-CARES / (800) 842-2737 For North and South America and U.S. Territories
International contact information:	education.ti.com/support/worldwide

For Technical Support

Knowledge Base and support by e-mail:	education.ti.com/support or ti-cares@ti.com
Phone (not toll-free):	(972) 917-8324

For Product (Hardware) Service

Customers in the U.S., Canada, Mexico, and U.S. territories: Always contact Texas Instruments Customer Support before returning a product for service.

For All Other Countries:

For general information

For more information about TI products and services, contact TI by e-mail or visit the TI Internet address.

E-mail inquiries:	ti-cares@ti.com
Home Page:	education.ti.com

Service and Warranty Information

For information about the length and terms of the warranty or about product service, refer to the warranty statement enclosed with this product or contact your local Texas Instruments retailer/distributor.

Index

3

3D aspect ratio, changing	317
3D functions	
graphing	311
3D graph	
changing appearance	315
3D Graphing view	311, 313
3D graphs	
animating with sliders	319
editing expressions	314
plot colors	315
range settings	318
rotating	313
setting background colors	317
showing/hiding	317
shrinking/magnifying	317
3D parametric equations	
graphing	312

A

activating software licenses	595
activities	
copying	34
filtering	32
keyword searches	32
opening	32
saving	33
adding	
(x,y) numerical input questions	185
applications	86
applications (PublishView™ documents)	114

colors	81
copyrights	173
copyrights to documents (.tns)	93
drop points questions	188
equation questions	181
files to lesson bundles	147
files to transfer list	52
images in Quick Poll	167
images to pages	167
images to questions	176
links	28
lists questions	189
open response questions	180
pages	90
problems	90
questions	176, 178
shortcuts	27
shortcuts to lesson bundles	154
text (PublishView™ documents)	128
titles to graphs	522
alternative hypothesis	411
analysis options	
removing	513
analyzing data	
integral	510
model	513
tangent	510
angles	
measuring	293, 342
animating	
points	303, 357
animations	
changing points direction	304, 357
pausing	303, 357
resetting	304, 357
resuming	303, 357

API level, setting for scripts	589
appearance	
of 3D graph	315
application	
tools menu	17
applications	
adding	86
Calculator	201
Data & Statistics	415
deleting	89
Geometry	321
Graphs & Geometry	237
grouping	89
inserting images	167
Lists & Spreadsheet	363
Notes	463
Program Editor	545
Question	171
swapping	87
approximate or exact results	377
arcs, drawing	281, 330
area, measuring	292, 341
arguments, user-supplied values	557
arithmetic calculations	308, 360
aspect ratio, changing in 3D graphing	317
attributes	
changing for objects	290, 339
for variables	223
axes	
adjusting	449
changing attributes in Graphing view	268
dilating	444
moving (translation)	444
scaling	444
setting values (Data & Statistics)	450

axis ranges	
setting in graphs	523

B

backup	
of class data	600
bar charts	
creating	433-434, 436
borders (PublishView™ documents), hiding/showing	123
box plots	422
breaking long calculations	472

C

Calculate output option	391
calculating distributions (Lists & Spreadsheet)	399
calculations	
arithmetic	308, 360
breaking	472
derivative settings	533
types available	396
using variables	230
Calculator	
menus	201
Calculator application	201
calculated results variables	235
Calculator history	
copying	219-220
deleting	221
reusing	220
viewing	219
captions, viewing variable names	416
capture page option	158
Capture Selected Handheld option	159

capturing	
active pages in documents	158
data (Lists & Spreadsheet)	388
handheld current screens	157
images in handheld mode	157
pages in active documents	157
capturing images	
DragScreen	164
caseplots (default)	416
Catalog	
converting measurement units	210
inserting items from	204, 207, 372, 391
cell references	
absolute and relative	371
using in formulas	372
cells	
body	366
copying in tables	372
deleting contents	372
entering text	367
exact or approximate results	377
formulas	366
inserting ranges in formulas	368
linking to variables	374
navigating in tables	370
repeating formulas	373
selecting a block of	372
selecting a range	368
sharing table cells	373
changing	
General Settings	69
Graphs & Geometry settings	71
language	18
links	29
changing screen size	576

charts	
bar	433
dot	431
pie	435
scatter	418
chemical equation boxes	473
circle arcs, creating	281, 330
circles, drawing	282, 331
Circular definition error	563
class data	
backup	600
Clickpad, navigating in emulator	577
closing	
functions and programs	553
Transfer Tool	58
closing documents (.tns)	79
closing the Welcome screen	14
collected data	
deleting	509
viewing details	509
collecting and managing data sets	507
color	
setting grid color in Graphs	268
colors	
3D graph background	317
applying to backgrounds	467
changing	289, 315, 338, 371, 456-457, 466
changing for points	528
colors, adding	81
columns	
based on other columns	379
copying	376
defining options	517
deleting	375
deleting data from	377
generating data in tables	379

inserting	206, 375
linking to list variables	365
moving	377
resizing	375
selecting	374, 529
sharing table columns as lists	364
commands	
If, Lbl, Goto	564
comments, inserting in Notes	468
comparing	
data sets	507
comparing collected data sets	507
confidence intervals available	405
conic by five points	286, 335
conics, graphing	248
constructions	
locus	288, 337
content	
viewing on handhelds	35
Content Explorer	66
content workspace	
exploring	20
Content workspace	15
Content Workspace	20
context menu in Lists & Spreadsheet	375
converting	
.tns files to .tnsp files	143
.tnsp files to .tns files	142
measurement units	210
page size; page size, converting; preview, setting document; setting	
document preview 81	
text to hyperlinks	136
copying	
activities	34
Calculator history	219-220

cells from Excel® spreadsheets	387
handheld images	157
images	158
images in handheld mode	157
lesson bundles	153
screens	163
table cells	372
table data	386
table rows or columns	376
copying problems	90
copyrights	
adding	173
adding to documents (.tns)	93
creating	
bar charts	433-434, 436
copies of functions and programs	549
histograms	426
lesson bundles	145-146, 153
lists from table columns	364
matrices	206
pie charts	435
plots	421
probability plots	428
PublishView™ documents	96
scatter plots	429
summary plots	384
system of equations	209
user-defined units	211
variables	224-225, 227
creating documents (.tns)	75
curve fit options	512
customizing	
Graphs work area	267

D

data	
backup of class data	600
capturing (Lists & Spreadsheet)	388
capturing object data (Graphs & Geometry)	388
copying to other applications	386
deleting from columns	377
displaying values	417, 421
exact or approximate results	377
generating columns of	379
graphing table data	382
raw and summary overview	420
retrieving remote	505
selecting ranges	526
sorting in tables	378
sorting plotted categories	441
Data & Statistics	
getting started with	415
data analysis	
interpolation	511
data collections	
remote sensors	503
scaling graphs	525
setting sensor parameters	493
thresholds	505
data plots	
finding curve fit	512
data sets	
comparing	507
deleting collected	509
renaming	508
selecting for replays	532
selecting to plot	524
storing	507

data sets, collecting and managing	507
debugging information	571
displaying in dialog boxes	559
displaying values	558
programs	571
defined functions, recalling	216
defining	
functions	208, 212-213
settings	18
units	211
deleting	
applications	89
Calculator history	221
collected data sets	509
contents of table cells	372
data from columns	377
documents (.tns)	78
elements from lists	366
files	55
global variables	561
hyperlinks (PublishView™ documents)	137
images	169
images (PublishView™ documents)	139
lesson bundles	153-154
linked variables	236
pages	89
parts of expressions	217
problems	90
PublishView™ objects	112
shortcuts	27
table rows and columns	375
derivative settings	
adjusting	533
Destination folder	
editing	54
diagnostics programs	598

differential equations, graphing	259
dilating axes	444
displaying	
data values	417, 421
Graph 1	516
graphs	515
graphs in Page Layout view	516
grid in Graphs	268
TI-SmartView™ emulator in teacher software	575
two graphs simultaneously	516
variable values	225
distribution, calculating	399
documents	
creating .tnsp files	96
printing .tnsp files	144
saving .tnsp files	100
documents (.tns)	
changing General Settings	69
closing	79
creating	75
deleting	78
opening	39, 76
opening with TI-SmartView™ emulator	580
printing	91
properties	92
protecting	94
read-only	94
saving	39, 77-78
saving in emulator	581
switching between	83
viewing	83
documents (.tns, .tnsp)	
opening (Content Workspace)	32
documents workspace	16
Documents Workspace	59
domain restrictions	243

dot charts	431
DragScreen feature	157, 164
drawing	
arcs	281, 330
rectangles	283, 332
statistics plots	461
triangles	282, 331
drawing geometric shapes	282, 331
drawing shapes	
ellipse	284, 333
drop points questions	
adding	188

E

editing	263
Destination folder	54
expressions	216
functions	263
functions and programs	549
table settings	413
values in lists	365
elements, deleting from lists	366
ellipse	
as geometric shape	284, 333
emailing lesson bundles	155
embedding	
values in functions or programs	556
emulator, See TI-SmartView™ emulator	62
equation questions	
adding	181
equations	
differential	259
graphing	248
graphing parametric	251
graphing polar	252

Lotka-Volterra	259
of geometric objects	307
ordinary differential equations (ODE)	259
errors	
circular definitions	563
showing (Notes)	472
estimating	
values between data points	511
evaluating expressions	205
exact or approximate results	377
Excel® spreadsheets, copying from	387
expanding view details area	509
experiments	
basic steps	486
exploring	
content workspace	20
resources pane	21
Exploring the Content workspace	15
Exploring the Documents workspace	16
expressions	263
changing functions in tables	413
copying from Calculator history	219-220
deleting parts of	217
editing	216, 314
entering from templates	204-205
entering in tables	367
entering with wizards	207, 391
evaluating	202, 472
selecting (Calculator)	216
selecting (Notes)	468
using symbols	255

F

File transfers	
stopping	57

files	
adding to lesson bundles	147, 151
adding to transfer list	52
copying/pasting from lesson bundles	151
deleting from lesson bundles	151
image file types	167
opening in lesson bundles	149, 151
pasting from lesson bundles	151
refreshing list in lesson bundles	151, 153
removing from Transfer List	53
renaming in lesson bundles	151
working with files on connected handhelds	38
Files	
deleting	55
filtering activities	32
finance functions	218
Finance Solver	217
finding	
area under collected data	510
slope of collected data	510
software version number	601
Flash (.flv) files	140
folders	
storing PublishView™ objects	113
footers in PublishView™ documents	122
formatting	
results (Calculator)	203
text (PublishView™ documents)	129
formatting text	79
formatting toolbar	
hiding	80
showing	80
frequency plots	384
functions	
changing expressions in tables	413
defining	208, 212-213

displaying history	265, 314
displaying list of in tables	413
domain restrictions	243
editing	263
evaluating	553
finance	218
graphing	240, 247, 451
hiding table of	263
hiding/showing	269
recalling definitions	216
renaming	264
rotating	240
showing values in tables	412
stretching	240
supported distributions	400
translating	240
user-defined	561
functions and programs	
changing modes	570
circular definition errors	563
closing	553
controlling flow	563
creating copies of	549
differences between	561
editing	549
embedding values	556
private libraries	555
public libraries	554
renaming	549
running non-library	555
setting modes	570
stopping	556
storing	549
viewing	549

G

generating	
columns of data	380
geometric objects	
equations of	307
geometric shapes	
conic by five points	286, 335
hyperbola	286, 335
parabola	285, 334
Geometry	
hiding objects	355
Geometry application	321
Geometry application settings	238, 322
global variables	561
graph	
changing appearance	315
graphing	
3D functions	311
3D parametric equations	312
3D view	311
conic sections	248
equations	248
functions	240, 247, 451
inequality expressions	255
parametric equations	251
polar equations	252
scatter plots	255
sequences	256
table data	382
time plots	256
web plots	256
with the text tool	253
Graphing view	
changing axes attributes	268

rescaling work area	266
graphs	
adding titles	522
displaying	515
displaying Graph 1	516
displaying in Page Layout view	516
displaying two simultaneously	516
position versus time	534
rescaling	444
scaling	525
setting axis range	523
tracing all	274
velocity versus time	534
Graphs & Geometry application	237
Graphs & Geometry settings	71
grid	
appearance in Graphs	268
displaying	268
grouping applications	89
guidebooks, downloading	597

H

handhelds	
capturing current screens	157
capturing selected handhelds	159
checking for OS updates	43
copying images	157
installing OS update	44
locating using Identify Selected	47
pasting images	157
renaming	46
transferring files	42
viewing content on connected	35
working with files on connected	38
headers in PublishView™ documents	122

Help, accessing	595
helping improve the product	602
hiding	
3D graphs	317
functions in work areas	269
objects in Geometry	355
table of functions	263
hiding format toolbar	80
histograms	
adjusting scale	426
creating	426
exploring data in bins	425
modifying bins	427-428
scale formats	426
history	
relation	265, 314
history, See Calculator history	219
hyperbola	
as geometric shape	286, 335
hyperlinks (PublishView™ documents)	
converting text to	136
editing	136
linking to files	131
linking to websites	134

I

Identify Selected	47
If, Lbl, Goto	564
images	
adding to questions	176
deleting	169
file types	167
inserting	167, 467
inserting background	239, 323, 355
moving	168

Quick Poll	167
resizing	169
saving	157-158
selecting	168
TI-Nspire™ applications	167
images (PublishView™ documents)	137, 139
importing	
remote data	505
inferential statistics	
calculating test results (Calculate)	391
drawing plots	461
graphing test results	391
input descriptions table	392
pooled option	412
initializing variables	560
inserting	
background images	239, 323, 355
cell ranges in formulas	368
chemical equations	468
comments in Notes	468
elements in lists (Lists & Spreadsheet)	366
hyperlinks (PublishView™ documents)	131
images	467
images (PublishView™ documents)	137
images in questions	176
images in Quick Poll	167
images to pages	167
math expressions	468
PublishView™ objects	108
rows or columns in tables	375
rows or columns into matrices	206
shape symbols	468
text	458
text (PublishView™ documents)	128
installing	
software updates	599

installing a handheld OS update	44
intercept, changing	446
interfaces	
multi-channel sensors	488
single-channel sensors	488
intervals	496

K

keypads, switching between	575
keyword searches	32

L

labeling	
point coordinates	306
language	
changing	18
LED lights	
sensors	504
lesson bundles	
adding files	147, 151
adding shortcuts to	154
copying	154
copying/pasting	153-154
copying/pasting files	151
creating	145-146, 153
deleting	153-154
deleting files	151
emailing	155
opening	149-150, 152, 154
opening files	149, 151
packaging	154-155
packaging pages	154
pasting	154
refreshing list of files	151, 153-154

renaming	153-154
renaming files	151
sending	154, 156
libraries	539
changing the access levels	552
Linear Algebra functions	543
private	555
public	554
refreshing	542
restoring	543
library objects	
creating shortcuts	542
private	540
public	541
using	541
Linear Algebra library functions	543
lines	
adding movable to plots	445
locking intercept at zero	447
rotating movable	446
tracing movable	447
lines (geometric)	
creating	278, 327
lines and points, creating	277, 326
linking	
columns to symbol table	517
table cells to variables	374
table columns to lists	365
to files	131
to websites	134
values between applications	223
variables	229
links	27
adding	28
changing	29
moving	30

removing	29
list math in Lists & Spreadsheet	368
lists	
deleting elements in tables	366
inserting elements in tables	366
sharing table columns as	364
viewing and editing	365
Lists & Spreadsheet application	363
lists questions	
adding	189
locating software updates	599
locking	
intercept of movable lines at zero	447
variables	233
locus construction	288, 337
loops	
EndLoop	569
For	566
using	566
While	568
Lotka-Volterra equations	259
Lua, scripts	583

M

managing collected data sets	507
math expression boxes	473-475
math expressions, See expressions	202
math templates	204
matrices	
creating	206
inserting rows or columns	206
measurement units	
changing (Vernier DataQuest™)	494
measurements, converting units	210

measuring	
angles	293, 342
circumference or perimeter	291, 340
distance between objects	291, 340
length	291, 340
sides of objects	292, 341
slope of object	293, 342
measuring objects	290, 339
menus	
Calculator	201
minimum API level for scripts	589
models, Pdf distribution	399
modes	
changing in functions and programs	570
setting in functions and programs	570
setting in programs	570
motion match	
options	534
removing plots	535
moving	
images	168
images (PublishView™ documents)	139
links	30
points (Data & Statistics)	440
PublishView™ objects	110
rows and columns (Lists & Spreadsheet)	377
multiple-line functions	212-213
multiple cells, selecting	372
multiple choice questions	
adding	178

N

naming	
table columns	364
variables (name conflicts)	374

naming columns	517
navigating in tables	369
normal probability, creating plots	428
Notes	
adding shapes	469
formatting text	465
inserting comments	468
selecting text	465
using colors	466
numeric plots, splitting by categories	438
numerical input questions	
adding	185

O

objects	
(PublishView™ documents)	106, 114
changing attributes	290, 339
changing fill colors	289, 338
dilating	297, 346
duplicating	296, 345
enlarging	297, 346
finding area	292, 341
hiding in Geometry	355
measuring	290, 339
reflecting	295, 344
rotating	297, 346
symmetrical images	295, 344
tracing geometric	352
transformation of	295, 344
open response questions	
adding	180
opening	
activities	32
documents (.tns)	39
files in lesson bundles	149

lesson bundles	149-150, 152, 154
Transfer Tool	52
opening documents (.tns)	76
options	
capture page	158
Capture Selected Handheld	159
organizing PublishView™ sheets	121
OS update	
installing on a handheld	44
overlapping PublishView™ objects	111

P

packaging lesson bundles	154
Page Layout view	516
page numbers (PublishView™ documents)	121
Page Sorter	61, 87
pages	
adding	90
deleting	89
grouping	89
packaging	154
rearranging	88
selecting	88
ungrouping	89
panes	
resource	21
parabola	
creating from focus and directrix	285, 334
creating from focus and vertex	285, 334
parametric equations	
graphing	251
pasting	
handheld images	157
images	158
images in handheld mode	157

lesson bundles	153
screens	163
table data	386
pasting problems	90
PDF	
save document as	91
pie charts, creating	435
piecewise functions	208
playbacks	
adjusting rate	532
pausing	531
repeating	533
starting	532
plots	
adding a value on existing plot	442
adding movable lines	445
caseplots (default)	416
changing type	443
colors in 3D graphs	315
creating	421
customizing	257
dot plots	421
graphing	255-256
predictive	534
probability	428
removing motion match	535
scatter	429
sorting categories	441
summary	384
X-Y line	430
plotting	
dot charts	431
models	513
statistical data	391
table data	382

points	
animating	303, 357
changing colors	528
changing direction	304, 357
creating	277, 326
identifying intersections	278, 327
labeling coordinates	306
moving (Data & Statistics)	440
of interest	244
selecting (Data & Statistics)	440
setting markers	529
setting options	527
points and lines, creating	277, 326
polar equations	
graphing	252
polygons, drawing	283, 332
pooled variances	412
pre-defined measurement units	210
precision of results	203
predictive plots	
drawing and clearing	534
preview, printed document	92
print preview	92
printing	
PublishView™ documents	144
printing documents (.tns)	91
probability, creating plots	428
problems	
adding	90
copying/pasting	90
deleting	90
renaming	91
problems (PublishView™ documents)	118, 120
product improvements	602
Program Editor application	545

programs	
calling one from another	562
debugging	571
defining	212
editing	549
flows	564
running	553
running diagnostics	598
Proof template	465
protecting documents (.tns)	94
PublishView™ documents	95
applications	114, 118
converting	141, 144
creating	96
hyperlinks	130, 137
images	137, 139
objects	106, 113
printing	144
problems	118
problemsdeleting	
problems (PublishView™ documents) 120	
saving	100
sheets	121, 127
text	127, 130
video files	140

Q

Q & A template	464
questions	
(x,y) numerical input	185
adding	176
adding images	176
drop points	188
equation	181
lists	189

multiple choice	178
open response	180
responding	196
Self Check mode	179
suggested responses	181
using the Question application	171
questions (students)	
checking answers	198
toolbar options	195
types of	195
Quick Graph, using	382
Quick Poll	
images	167
Quick Poll questions	
clearing answers	199
responding	196
types	197

R

random numbers	
generating in tables	380
range of cells, inserting in formulas	368
raw data	420
raw data, adjusting histogram scale	426
rays	
creating	279, 328
read-only documents (.tns)	94
reducing view details area	509
registering products	597
regression lines, showing	447
relations	
displaying history	265, 314
showing table of values	263
remote data	
retrieving	505

removing	
hyperlinks from text	137
images	169
linked variables	236
links	29
removing files from Transfer list	53
renaming	
data sets	508
functions	264
functions and programs	549
lesson bundles	153-154
problems (PublishView™ documents)	120
renaming problems	91
replays	
starting	532
reponses	
adding suggested	181
repositioning images	168
rescaling	
graphs (dilation)	444
graphs (translation)	444
resizing	
images	169
images (PublishView™ documents)	139
PublishView™ objects	110
table rows and columns	375
resources pane	
exploring	21
restoring data	531
restoring libraries	543
results	
copying from Calculator history	219-220
setting decimal approximation	203
rotating objects	297, 346
rows	
copying	376

deleting	375
inserting	206, 375
moving	377
resizing	375
selecting	374

S

Save	
document as PDF	91
saving	
activities to your computer	33
captured images	157
captured pages	161
documents (.tns)	39
documents (.tns) in emulator	581
handheld screens	161
images	158
PublishView™ documents	100
PublishView™ document as PDF	144
saving documents (.tns)	77-78
scaling graphs	525
scaling Plane Geometry Analytic window	266
scatter plots	429
screen capture tool	157
screen captures	
copying	163
pasting	163
scripts	
setting API level	589
scripts, Lua	583
scrolling in tables	369
searching for activities	32
segments	
creating	279, 328

selecting	
a block of table cells	372
columns	529
data ranges	526
data sets for replays	532
data sets to plot	524
expressions in Calculator	216
images	168
table rows or columns	374
templates	464
text in Notes	465
working folder (PublishView™ objects)	113
selecting pages	88
self-check	
document types	174
Self-Check mode	179
sensors	
calibrating	495
changing measurement units	494
connecting	493
for computers	490
for handhelds	489
for remote data collections	503
interfaces	488
LED lights	504
reversing reading display	496
setting to zero	496
setting up offline	493
triggering	505
types	489
sequences, generating in table columns	381
sets	
renaming data sets	508
sets of data, comparing	507
sets, storing data as	507

setting	
minimum API level for scripts	589
settings	
defining	18
in Geometry application	238, 322
language	18
TI-SmartView™ emulator	578
shapes	
adding in Notes	469
drawing geometric	282, 331
equations of	307
legends	419
shortcuts	27
creating to library objects	542
showing	
3D graphs	317
functions in work areas	269
showing format toolbar	80
showing screen details	530
sliders	
animating 3D graphs	319
setting variable values	231
slope	510
measuring	293, 342
software	
checking for updates	599
installing updates	599
software licenses, activating	595
software version number	601
solving simple math expressions	202
sorting	
plotted categories	441
table data	378
splitting numeric plots by categories	438
spreadsheets	
navigating	369

sharing columns as lists	364
starting	
transfer	56
statistical tests, supported	407
statistics, drawing plots	461
status bar	17
stopping	
file transfers	57
storing	
data as sets	507
striking data	530
strip charts	497
subroutines, calling	562
suggested response	174
summary data	420
summary information, displaying	417
summary plots	382, 384
creating	384
symbol table	
linking columns to	517
syntax	
checking	548
using to prevent naming conflicts	374
system of equations	209

T

table data	
graphing	382
sorting	378
using in statistical analysis (Lists & Spreadsheet)	391
table of values	263
tables	
changing expressions for functions	413
copying rows or columns	376
deleting contents of cells	372

deleting list elements	366
deleting rows and columns	375
displaying list of functions	413
editing settings	413
generating column data	379
inserting list elements	366
inserting rows or columns	375
linking columns to lists	365
moving rows or columns	377
navigating in	369
restoring data	531
selecting rows or columns	374
sharing columns as lists	364
showing function values	412
striking data	530
working with cells	370
tangents, creating	280, 329
Teacher Tool Palette	173
templates	
math	204-205
Notes	464
Proof	465
Q & A	464
selecting	464
text	
adding to work areas	239, 267, 323, 356
changing colors	466
entering	367
finding in Program Editor	552
formatting (Notes)	465
selecting in Notes	465
text formatting	79
text tool	
using to graph equations	253
threshold values	
increasing/decreasing	505

TI-Nspire(TM) Screen Capture Window	160
zooming in/out	161
TI-Nspire™ SmartView Emulator	
capturing images	163
TI-SmartView™	
capturing images	157
DragScreen feature	157
TI-SmartView™ emulator	62, 576
capturing screens	581
changing panel width	576
opening	573
opening documents (.tns)	580
options	579
saving documents (.tns)	581
settings	578
TI-SmartView™ Emulator	573
TI websites	598
titles, clicking to see variable names (Data & Statistics)	416
tool palette	17
toolbar	17
text formatting	79
tools	
screen capture	157
Touchpad, navigating in emulator	577
tracing	
all graphs simultaneously	274
geometric objects	352
Transfer	
starting	56
Transfer List	
removing files	53
Transfer Tool	49
adding files	52
closing	58
interface	49
opening	52

removing files	53
transferring files to connected handhelds	42
transformation of objects	295, 344
triggering	
enabling	506-507
troubleshooting information	598

U

undefined variables	560
ungrouping	
applications	89
pages	89
units	
converting measurement symbols	210
creating user-defined	211
unlinking variables	236
unlocking	
variables	233
user-defined functions	561
Using the Preview Pane	23
Using the Welcome screen	13

V

values	
assigning to variables	557
linking between applications	223
requesting for variables	558
user-supplied for arguments	557
variables	211
assigning values	557
attributes	223
calculated results	235
creating	225, 227
creating from table cells	373

deleting	561
displaying value	225
from calculator values	224
in calculations	230
in Graphs & Geometry	225
in Lists & Spreadsheet	227
initializing	560
linking	229
linking table columns to lists	365
linking to	374
linking to shared	229
locking and unlocking	233
naming	231
preventing naming conflicts	374
removing linked variables	236
requesting values	558
setting values with sliders	231
sharing table columns as lists	364
types of	224
undefined	560
unlinking	236
variances, pooled	412
vectors	
creating	280, 329
version number, locating	601
videos (PublishView™ documents)	
inserting files	140
video console	141
view	
3D Graphing	311
viewing	
captured screens	160
documents (.tns)	83
functions and programming	549
values in lists	365

views	
3D Graphing	313
Graph	486
Page Layout	516
Table	486

W

warnings, showing (Notes)	472
websites, locating troubleshooting information	598
welcome screen	13
Welcome Screen	
closing	14
windows	
TI-Nspire(TM) Screen Capture	160
wizards	
entering expressions (Calculator)	207
entering expressions (Lists & Spreadsheet)	391
statistics	391
work area	
customizing in Graphs and Geometry	267
work areas	
adding text to	239, 267, 323, 356
workspace	
Content	15
Documents	16
workspaces	
Content Workspace	20
Documents Workspace	59
exploring	20

X

X-Y line plots	430
----------------------	-----

Z

zooming	266
in	527
in/out	161
out	527
PublishView™ documents	127