



# TI-Nspire™ CX Student Software Guidebook

Learn more about TI Technology through the online help at [education.ti.com/eguide](http://education.ti.com/eguide).

## ***Important Information***

Except as otherwise expressly stated in the License that accompanies a program, Texas Instruments makes no warranty, either express or implied, including but not limited to any implied warranties of merchantability and fitness for a particular purpose, regarding any programs or book materials and makes such materials available solely on an "as-is" basis. In no event shall Texas Instruments be liable to anyone for special, collateral, incidental, or consequential damages in connection with or arising out of the purchase or use of these materials, and the sole and exclusive liability of Texas Instruments, regardless of the form of action, shall not exceed the amount set forth in the license for the program. Moreover, Texas Instruments shall not be liable for any claim of any kind whatsoever against the use of these materials by any other party.

© 2021 Texas Instruments Incorporated

Adobe®, Excel®, Mac®, Microsoft®, PowerPoint®, Vernier DataQuest™, Vernier EasyLink®, Vernier EasyTemp®, Vernier Go!Link®, Vernier Go!Motion®, Vernier Go!Temp®, Windows®, and Windows® XP are trademarks of their respective owners.

Actual products may vary slightly from provided images.

## Contents

<b>Getting Started with TI-Nspire™ CX Student Software</b> .....	<b>1</b>
Selecting the Handheld Type .....	1
Exploring the Documents Workspace .....	2
Changing Language .....	3
Using Software Menu Shortcuts .....	4
Using Handheld Keyboard Shortcuts .....	8
<b>Using the Documents Workspace</b> .....	<b>13</b>
Exploring the Documents Workspace .....	13
Using the Documents Toolbox .....	13
Exploring Document Tools .....	14
Exploring the Page Sorter .....	15
Exploring the TI-SmartView™ Feature .....	16
Exploring Content Explorer .....	18
Exploring Utilities .....	20
Using the Work Area .....	21
Changing Document Settings .....	22
Changing Graphs & Geometry Settings .....	24
<b>Working with Connected Handhelds</b> .....	<b>26</b>
Managing Files on a Connected Handheld .....	26
Checking for an OS Update .....	28
Installing an OS Update .....	29
<b>Working with TI-Nspire™ Documents</b> .....	<b>33</b>
Creating a New TI-Nspire™ Document .....	33
Opening an Existing Document .....	34
Saving TI-Nspire™ Documents .....	35
Deleting Documents .....	36
Closing Documents .....	36
Formatting Text in Documents .....	37
Using Colors in Documents .....	38
Setting Page Size and Document Preview .....	38
Working with Multiple Documents .....	40
Working with Applications .....	41
Selecting and Moving Pages .....	44
Working with Problems and Pages .....	47
Printing Documents .....	49
Viewing Document Properties and Copyright Information .....	50

<b>Working with PublishView™ Documents</b> .....	<b>52</b>
Creating a New PublishView™ Document .....	52
Saving PublishView™ Documents .....	56
Exploring the Documents Workspace .....	58
Working with PublishView™ Objects .....	61
Working with TI-Nspire™ Applications .....	68
Working with Problems .....	71
Organizing PublishView™ Sheets .....	74
Using Zoom .....	80
Adding Text to a PublishView™ Document .....	80
Using Hyperlinks in PublishView™ Documents .....	82
Working with Images .....	89
Working with Video Files .....	92
Converting Documents .....	93
Printing PublishView™ Documents .....	95
<b>Working with Lesson Bundles</b> .....	<b>97</b>
Creating a New Lesson Bundle .....	97
Adding Files to a Lesson Bundle .....	98
Opening a Lesson Bundle .....	100
Managing Files in a Lesson Bundle .....	101
Managing Lesson Bundles .....	103
Packaging Lesson Bundles .....	105
Emailing a Lesson Bundle .....	106
Sending Lesson Bundles to Connected Handhelds .....	107
<b>Capturing Screens</b> .....	<b>108</b>
Accessing Screen Capture .....	108
Using Capture Page .....	108
Using Capture Selected Handheld .....	109
Viewing Captured Screens .....	110
Saving Captured Pages and Screens .....	111
Copying and Pasting a Screen .....	113
Capturing Images in Handheld Mode .....	113
<b>Working with Images</b> .....	<b>116</b>
Working with Images in the Software .....	116
<b>Responding to Questions</b> .....	<b>120</b>
Understanding the Question Toolbar .....	120
Types of Questions .....	120
Responding to Quick Poll Questions .....	121

Submitting Responses .....	123
<b>Calculator Application .....</b>	<b>124</b>
Entering and Evaluating Math Expressions .....	125
CAS: Working with Measurement Units .....	132
Using the Unit Conversion Assistant .....	134
Working with Variables .....	136
Creating User-defined Functions and Programs .....	137
Editing Calculator Expressions .....	141
Financial Calculations .....	141
Working with the Calculator History .....	143
<b>Using Variables .....</b>	<b>146</b>
Linking Values on Pages .....	146
Creating Variables .....	146
Using (Linking) Variables .....	151
Naming Variables .....	153
Adjusting Variable Values with a Slider .....	154
Locking and Unlocking Variables .....	157
Removing a Linked Variable .....	159
<b>Graphs Application .....</b>	<b>160</b>
What You Must Know .....	161
Graphing Functions .....	163
Exploring Graphs with Path Plot .....	164
Manipulating Functions by Dragging .....	165
Specifying a Function with Domain Restrictions .....	167
Finding Points of Interest on a Function Graph .....	168
Graphing a Family of Functions .....	170
Graphing Equations .....	171
Graphing Conic Sections .....	172
Graphing Relations .....	175
Graphing Parametric Equations .....	178
Graphing Polar Equations .....	178
Graphing Scatter Plots .....	179
Plotting Sequences .....	180
Graphing Differential Equations .....	182
Viewing Tables from the Graphs Application .....	185
Editing Relations .....	186
Accessing the Graph History .....	187
Zooming/Rescaling the Graphs Work Area .....	188
Customizing the Graphs Work Area .....	190

Hiding and Showing Items in the Graphs Application .....	193
Conditional Attributes .....	194
Calculating a Bounded Area .....	195
Tracing Graphs or Plots .....	197
Introduction to Geometric Objects .....	199
Creating Points and Lines .....	200
Creating Geometric Shapes .....	206
Creating Shapes Using Gestures (MathDraw) .....	211
Basics of Working with Objects .....	214
Measuring Objects .....	217
Transforming Objects .....	223
Exploring with Geometric Construction Tools .....	226
Animating Points on Objects .....	230
Adjusting Variable Values with a Slider .....	231
Labeling (Identifying) the Coordinates of a Point .....	234
Displaying the Equation of a Geometric Object .....	234
Using the Calculate Tool .....	235
<b>3D Graphs .....</b>	<b>237</b>
Graphing 3D Functions .....	237
Graphing 3D Parametric Equations .....	238
Rotating the 3D View .....	239
Editing a 3D Graph .....	240
Accessing the Graph History .....	240
Changing the Appearance of a 3D Graph .....	241
Showing and Hiding 3D Graphs .....	242
Customizing the 3D Viewing Environment .....	242
Tracing in the 3D View .....	244
Example: Creating an Animated 3D Graph .....	245
<b>Geometry Application .....</b>	<b>247</b>
What You Must Know .....	247
Introduction to Geometric Objects .....	250
Creating Points and Lines .....	252
Creating Geometric Shapes .....	257
Creating Shapes Using Gestures (MathDraw) .....	263
Basics of Working with Objects .....	266
Measuring Objects .....	269
Transforming Objects .....	274
Exploring with Geometric Construction Tools .....	277
Using Geometry Trace .....	282
Conditional Attributes .....	282

Hiding Objects in the Geometry Application .....	284
Customizing the Geometry Work Area .....	284
Animating Points on Objects .....	285
Adjusting Variable Values with a Slider .....	286
Using the Calculate Tool .....	289
<b>Lists &amp; Spreadsheet Application .....</b>	<b>291</b>
Creating and Sharing Spreadsheet Data as Lists .....	292
Creating Spreadsheet Data .....	294
Navigating in a Spreadsheet .....	296
Working with Cells .....	297
Working with Rows and Columns of Data .....	301
Sorting Data .....	304
Generating Columns of Data .....	305
Graphing Spreadsheet Data .....	308
Exchanging Data with Other Computer Software .....	312
Capturing Data from Graphs & Geometry .....	315
Using Table Data for Statistical Analysis .....	320
Statistics Input Descriptions .....	320
Statistical Calculations .....	322
Distributions .....	326
Confidence Intervals .....	332
Stat Tests .....	334
Working with Function Tables .....	339
<b>Data &amp; Statistics Application .....</b>	<b>341</b>
Basic Operations in Data & Statistics .....	342
Overview of Raw and Summary Data .....	346
Working with Numeric Plot Types .....	347
Working with Categorical Plot Types .....	357
Exploring Data .....	366
Using Window/Zoom Tools .....	375
Graphing Functions .....	376
Using Graph Trace .....	382
Customizing Your Workspace .....	382
Adjusting Variable Values with a Slider .....	384
Inferential Statistics .....	386
<b>Notes Application .....</b>	<b>388</b>
Using Templates in Notes .....	389
Formatting Text in Notes .....	390
Using Color in Notes .....	391

Inserting Images .....	392
Inserting Items on a Notes Page .....	392
Inserting Comments in Notes Text .....	393
Inserting Geometric Shape Symbols .....	393
Entering Math Expressions in Notes Text .....	394
Evaluating and Approximating Math Expressions .....	395
Using Math Actions .....	397
Graphing from Notes and Calculator .....	400
Inserting Chemical Equations in Notes .....	401
Deactivating Math Expression Boxes .....	402
Changing the Attributes of Math Expression Boxes .....	403
Using Calculations in Notes .....	404
Exploring Notes with Examples .....	405
<b>Data Collection .....</b>	<b>410</b>
What You Must Know .....	411
About Collection Devices .....	412
Connecting Sensors .....	416
Setting Up an Offline Sensor .....	417
Modifying Sensor Settings .....	418
Collecting Data .....	420
Using Data Markers to Annotate Data .....	423
Collecting Data Using a Remote Collection Unit .....	426
Setting Up a Sensor for Automatic Triggering .....	428
Collecting and Managing Data Sets .....	430
Using Sensor Data in Programs .....	433
Collecting Sensor Data using RefreshProbeVars .....	434
Analyzing Collected Data .....	435
Displaying Collected Data in Graph View .....	441
Displaying Collected Data in Table View .....	442
Customizing the Graph of Collected Data .....	446
Striking and Restoring Data .....	456
Replaying the Data Collection .....	456
Adjusting Derivative Settings .....	458
Drawing a Predictive Plot .....	459
Using Motion Match .....	460
Printing Collected Data .....	460
<b>Widgets .....</b>	<b>463</b>
Creating a Widget .....	463
Adding a Widget .....	463
Saving a Widget .....	466



<b>Libraries</b>	<b>467</b>
Creating Libraries and Library Objects	467
Private and Public Library Objects	468
Using Library Objects	469
Creating Shortcuts to Library Objects	470
Included Libraries	470
Restoring an Included Library	470
<b>Using the TI-SmartView™ Emulator</b>	<b>472</b>
Opening the TI-SmartView™ Emulator	472
Choosing Display Options	473
Working with the Emulated Handheld	474
Using the Touchpad	475
Using Settings and Status	475
Changing TI-SmartView™ Options	476
Working with Documents	477
Using Screen Capture	477
<b>Using the Help Menu</b>	<b>479</b>
Activating Your Software License	479
Registering Your Product	481
Downloading the Latest Guidebook	481
Exploring TI Resources	481
Updating the TI-Nspire™ Software	482
Updating the OS on a Connected Handheld	482
Viewing Software Version and Legal Information	483
Helping Improve the Product	484
<b>Using Test Mode</b>	<b>485</b>
Entering Test Mode by Choosing Restrictions	485
Entering Test Mode with a Test Code	487
Reviewing Test Mode Restrictions	490
Working with a Document in Test Mode	491
Exiting Test Mode	493
Understanding Test Mode Restrictions	493
<b>Appendix A: Conversion Categories and Units</b>	<b>497</b>
<b>General Information</b>	<b>501</b>
<b>Index</b>	<b>502</b>

# Getting Started with TI-Nspire™ CX Student Software

TI-Nspire™ CX Student Software enables students to use PC and Mac® computers to perform the same functions as on a handheld. This document covers:

- TI-Nspire™ CX Student Software
- TI-Nspire™ CX CAS Student Software

**Note:** When there are differences between the software, those differences are described.

## Selecting the Handheld Type

When you launch the software for the first time, you will see the Handheld Type selection dialog box:

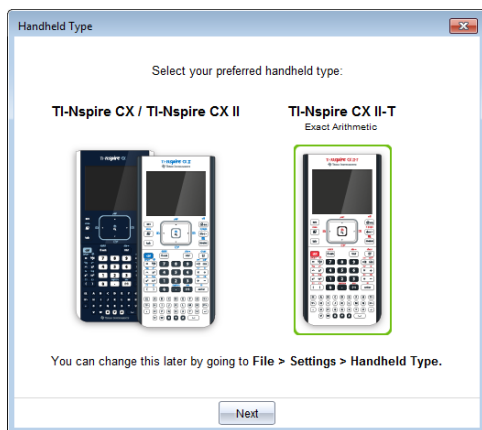

Click the image of the handheld type you want to use then click **Next** to apply that selection and open the software.

To change the handheld type after the first launch:

1. Click **File > Settings > Handheld Type** and select the type you want.

The Handheld Type confirmation dialog box opens.

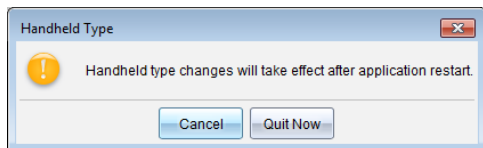

2. Click **Cancel** to continue your work.

—or—

Click **Quit Now** to close the software immediately. You will be prompted to save any open documents. When you restart the software, the new handheld type will be applied.

## Exploring the Documents Workspace

Use the menu options and toolbar options in the workspace to create or edit TI-Nspire™ and PublishView™ documents and work with applications and problems. The tools in the workspace are specific to working with open documents.

**Note:** Although not labeled, the Documents Workspace is the default workspace in the TI-Nspire™ CX Student Software. Throughout the documentation and help, the area where you work with documents is referred to as the Documents Workspace.

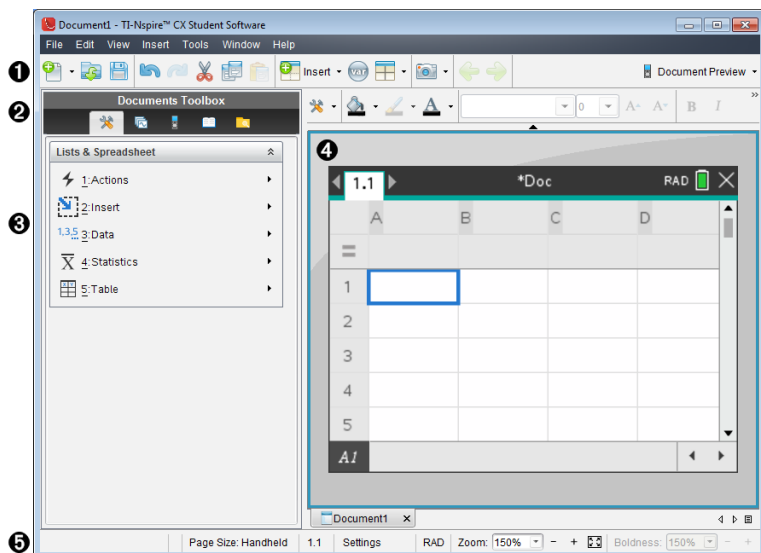

- 1 Toolbar.** Contains shortcuts to frequently performed tasks such as creating new documents, opening existing documents, saving documents, inserting applications, inserting variables, and taking screen captures. The cut, copy, and paste icons are also located in the toolbar. At the right side, a **Document Preview** button lets you select Handheld or Computer preview.
- 2 Documents Toolbox.** Contains tools needed to work with TI-Nspire™ and PublishView™ documents. Use these tools to open the application menus, use the page sorter to view TI-Nspire™ documents, open the TI-SmartView™ emulator, open Content Explorer, insert utilities such as math templates and the symbols from the catalog, and insert text and images into PublishView™ documents. Click each icon to access the available tools.
- 3 Toolbox pane.** Options for the selected tool are displayed in this area. For example, click the Document Tools icon to access tools needed to work with the active application.

- 4 Work area.** Shows the current page of the active (selected) document. Lets you perform calculations, add applications, and add problems and pages. Only one document at a time is active. Multiple documents appear as tabs.
- 5 Status bar.** Provides information about the active document.

### Understanding the Status Bar

The status bar provides information about the current document, and provides options that enable you to toggle between Handheld and Computer view and adjust how the document appears in the work area.

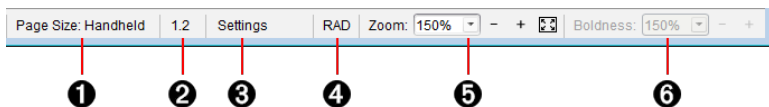

- 1 Page Size.** Shows the document's page size as Handheld or Computer. You can use the TI-Nspire™ **File** menu to convert a document from one page size to the other.
- 2 Problem/Page counter.** The first value represents the problem number of the active page, and the second value tells you the page number within the problem. In the example, the counter reads **1.2**, indicating Problem **1**, Page **2**.
- 3 Settings.** Double-click to view or change the Document Settings for the active document or to change the default Document Settings.
- 4 Mode.** Shows the angle mode (RAD, DEG, GRAD) for the current page of the document, or for the active Math Box in a Notes application.
- 5 Zoom.** Enabled in Handheld preview only (click **Document Preview** on the toolbar and select **Handheld**). Click ▼ and select a magnification value for the preview.
- 6 Boldness.** Enabled in Computer preview only (click **Document Preview** on the toolbar and select **Computer**). Click ▼ and select a value to increase or decrease the boldness of text and other items.

### Changing Language

Use this option to select a preferred language. You must restart the software for the language to take effect.

1. Click **File > Settings > Change Language**.

The Choose a Language dialog box opens.

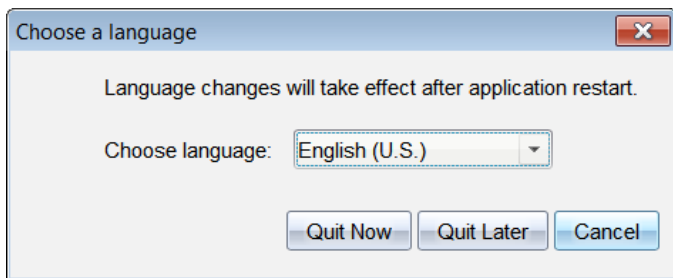

2. Click ▼ to open the Choose language drop-down list.
3. Select the desired language.
4. Click **Quit Now** to close the software immediately. You will be prompted to save any open documents. When you restart the software, the language change is effective.

—or—

Click **Quit Later** to continue your work. The language change is not applied until you close and restart the software at a later time.

## Using Software Menu Shortcuts

Use the following software menu shortcuts to perform common functions.

**Note:** Mac® users should substitute ⌘ (Cmd) anywhere Ctrl is used.

<b>Getting Help</b>	
Help	F1
Online Help	F2
<b>Editing Text</b>	
Cut	Ctrl+X
Copy	Ctrl+C
Paste	Ctrl+V
Undo	Ctrl+Z Ctrl+Esc
Redo	Ctrl+Y Shift+Esc
Toggle approximate and exact results	Ctrl+Enter

<b>Python Editor and Shell:</b> Add a new line after the current line.	
<b>Inserting Characters and Symbols in a document</b>	
Manual data capture point	Ctrl+.
Equals symbol	=
Insert variable	Ctrl+L
<b>Managing Documents</b>	
Display Document Tools menu	Ctrl+Shift+M
Open document	Ctrl+O
Close document	Ctrl+W
Create new document	Ctrl+N
Create new PublishView™ document	Ctrl+Shift+N
Insert new page	Ctrl+I
Select application	Ctrl+K
Save current document	Ctrl+S
<b>Navigation</b>	
Top of page  <b>Python Editor and Shell:</b> Moves cursor to the beginning of the first line in the program.	Ctrl+7
End of page  <b>Python Editor and Shell:</b> Moves cursor to the end of the last line in the program.	Ctrl+1
Page Up	Ctrl+9
Page Down	Ctrl+3
Up a level in the hierarchy	Ctrl+▲

Down a level in the hierarchy	<b>Ctrl+▼</b>
Extends selection in direction of arrow	<b>Shift+Any arrow</b>
<b>Python Editor and Shell:</b> Indents text on the current line or selected lines or navigates between inline prompts	<b>Tab</b>
<b>Navigating in Documents</b>	
Displays previous page	<b>Ctrl+◀</b>
Displays next page	<b>Ctrl+▶</b>
Displays Page Sorter	<b>Ctrl+▲</b>
Exits Page Sorter	<b>Ctrl+▼</b>
Moves focus backward within page  <b>Python Editor and Shell:</b> Dedents text on the current line or selected lines or navigates backwards between inline prompts	<b>Shift+Tab</b>
<b>Wizards and Templates</b>	
Add a column to a matrix after the current column	<b>Shift+Enter</b>
Add a row to a matrix after the current row  <b>Python Editor and Shell:</b> Add a new line after the current line.	<b>Enter</b>
<b>Application-Specific Shortcuts</b>	
<b>Notes/Program Editor/Python Editor:</b> Select all  <b>Press-to-Test:</b> Select all items in the dialog	<b>Ctrl+A</b>
<b>Program Editor/Python Editor:</b> Check syntax and store	<b>Ctrl+B</b>
<b>Program Editor/Python Editor:</b> Find	<b>Ctrl+F</b>
<b>Geometry/Graph:</b> Hide/Show Entry Line	<b>Ctrl+G</b>
<b>Lists &amp; Spreadsheet/Program Editor/Python Editor:</b>	

























Go To	
<b>Program Editor/Python Editor:</b> Find and Replace	<b>Ctrl+H</b>
<b>Calculator/Program Editor/Python Editor and Shell:</b> Beginning of line	<b>Ctrl+8</b>
<b>Calculator/Program Editor/Python Editor and Shell:</b> End of line	<b>Ctrl+2</b>
<b>Notes:</b> Insert math expression box	<b>Ctrl+M</b>
<b>Notes:</b> Insert chemical equation box	<b>Ctrl+E</b>
<b>Lists &amp; Spreadsheet:</b> Recalculate  <b>Program Editor:</b> Check syntax, store program and paste program name in Calculator (after clearing current line in Calculator)  <b>Python Editor:</b> Check syntax, save program and execute in Python Shell  <b>Python Shell:</b> Rerun last program	<b>Ctrl+R</b>
<b>Geometry/Graphs/Lists &amp; Spreadsheet:</b> Add Function Table  <b>Program Editor/Python Editor and Shell:</b> Add/remove comment symbol	<b>Ctrl+T</b>
Group/Ungroup applications on a page	<b>Ctrl+4 / Ctrl+6</b>
<b>Miscellaneous</b>	
Handheld Preview	<b>Alt+Shift+H</b>
Computer Preview	<b>Alt+Shift+C</b>
Transfer Tool (Teacher Software only)	<b>Ctrl+Shift+T</b>
Quick Poll (Teacher Software only)	<b>Ctrl+Alt+Q</b>
Capture Class (Teacher Software only)	<b>Ctrl+Shift+R</b>
Capture Page	<b>Ctrl+J</b>



































Rename (Content Workspace only)	<b>F2</b>
Print	<b>Ctrl+P</b>
Exit Software	<b>Alt+F4</b>

## Using Handheld Keyboard Shortcuts











Use the following handheld emulator keyboard shortcuts to perform common functions.

<b>Getting Help</b>	
Open Hints	 
<b>Editing Text</b>	
Cut	 
Copy	 
Paste	 
Undo	   
Redo	   
Toggle approximate and exact results	 
<b>Python Editor and Shell:</b> Add a new line after the current line.	
English: Change key to include appropriate accent Chinese: Insert character	
<b>Inserting Characters and Symbols in a document</b>	
Display character/symbol palette	 
Underscore	 
Display math template palette	

Backslash ( \ )	 
Manual data capture point	 
Clear	 
Caps Lock	 
Store	 
Square brackets	 
Curly brackets	 
Display Trig symbol palette	
Equals symbol	
Display pi symbols palette ( $\pi$ , $\sqrt{\quad}$ , $\theta$ , and so on)	
Display equality/inequality palette ( $>$ , $<$ , $\neq$ , $\leq$ , $\geq$ , and $ $ )	 
Display marks and letter symbols palette ( $?$ $!$ $\$$ $^{\circ}$ $'$ $\%$ $"$ $:$ $;$ $_$ $\backslash$ )	
Square root	 
log	 
ln	 
ans	 
<b>Managing Documents</b>	
Open document menu	
Open document	 
Close document	 

Create new document	<b>N</b>
Insert new page	<b>I</b>
Select application	<b>K</b>
Save current document	<b>S</b> 
<b>Navigation</b>	
Top of page  <b>Python Editor and Shell:</b> Moves cursor to the beginning of the first line in the program.	<b>7</b>
End of page  <b>Python Editor and Shell:</b> Moves cursor to the end of the last line in the program.	<b>1</b>
Page Up	<b>9</b>
Page Down	<b>3</b>
Up a level in the hierarchy	▲
Down a level in the hierarchy	▼
Context menu for selection	
Extends selection in direction of arrow	Any arrow
<b>Python Editor and Shell:</b> Indents text on the current line or selected lines or navigates between inline prompts	
<b>Navigating in Documents</b>	
Displays previous page	◀
Displays next page	▶

Displays Page Sorter	
Exits Page Sorter	
Switch between applications on a split page	
Moves focus backward within page  <b>Python Editor and Shell:</b> Dedents text on the current line or selected lines or navigates backwards between inline prompts	
<b>Wizards and Templates</b>	
Add a column to a matrix after the current column	
Add a row to a matrix after the current row  <b>Python Editor and Shell:</b> Add a new line after the current line.	
Integration template	
Derivative template	
Math template palette	or
Fraction template	
<b>Modifying Display</b>	
Increase contrast	
Decrease contrast	
Power off	
<b>Application-Specific Shortcuts</b>	
<b>Notes/Program Editor/Python Editor:</b> Select all	
<b>Press-to-Test:</b> Select all items in the dialog	
<b>Program Editor/Python Editor:</b> Check syntax and store	

<b>Program Editor/Python Editor:</b> Find	
<b>Geometry/Graph:</b> Hide/Show Entry Line	
<b>Lists &amp; Spreadsheet/Program Editor/Python Editor:</b> Go To	
<b>Program Editor/Python Editor:</b> Find and Replace	
<b>Calculator/Program Editor/Python Editor and Shell:</b> Beginning of line	
<b>Calculator/Program Editor/Python Editor and Shell:</b> End of line	
<b>Notes:</b> Insert math expression box	
<b>Notes:</b> Insert chemical equation box	
Open the Scratchpad	
<b>Lists &amp; Spreadsheet:</b> Recalculate  <b>Program Editor:</b> Check syntax, store program and paste program name in Calculator (after clearing current line in Calculator)  <b>Python Editor:</b> Check syntax, save program and execute in Python Shell  <b>Python Shell:</b> Rerun last program	
<b>Geometry/Graphs/Lists &amp; Spreadsheet:</b> Add Function Table  <b>Program Editor/Python Editor and Shell:</b> Add/remove comment symbol	
Group/Ungroup applications on a page	

# Using the Documents Workspace

Use this workspace to create, modify, and view TI-Nspire™ and PublishView™ documents, and to demonstrate mathematical concepts.

## Exploring the Documents Workspace

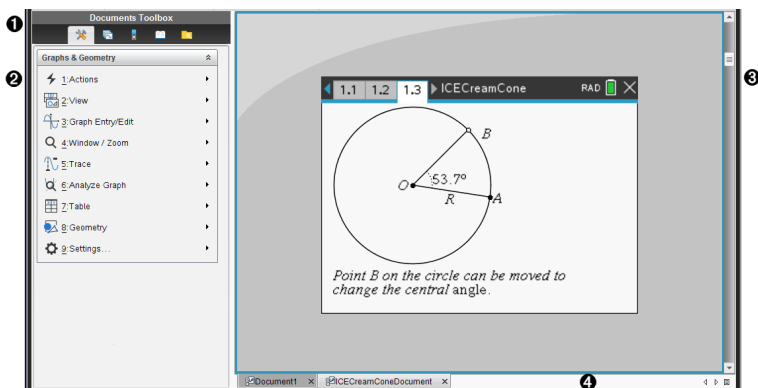

- 1 Documents Toolbox.** Contains tools such as the Document Tools menu, Page Sorter, TI-SmartView™ emulator, Utilities, and Content Explorer. Click each icon to access the available tools. When you are working in a TI-Nspire™ document, the tools available are specific to that document. When you are working in a PublishView™ document, the tools are specific to that document type.
- 2 Toolbox pane.** Options for the selected tool are displayed in this area. For example, click the Document Tools icon to access tools needed to work with the active application.  
**Note:** In the TI-Nspire™ CX Premium Teacher Software, the tool for configuring questions opens in this space when you insert a question. For more information, see *Using Question in the Teacher Software*.
- 3 Work area.** Shows the current document and enables you to perform calculations, add applications, and add pages and problems. Only one document at a time is active (selected). Multiple documents appear as tabs.
- 4 Document information.** Shows the names of all open documents. When there too many open documents to list, click the forward and backward arrows to scroll through the open documents.

## Using the Documents Toolbox

The Documents Toolbox, located on the left side of the workspace, contains tools needed for working with both TI-Nspire™ documents and PublishView™ documents. When you click a toolbox icon, the associated tools appear in the Toolbox pane.

## Documents Toolbox



### Exploring Document Tools

In the following example, the Document Tools menu is open showing the options for the Calculator application. In TI-Nspire™ documents, the Document Tools menu contains tools available for working with an application. The tools are specific to the active application.

In PublishView™ documents, the Document Tools menu contains tools needed to insert TI-Nspire™ applications and TI-Nspire™ documents, as well as multimedia objects such as text boxes, images, and links to websites and files. For more information, see *Working with PublishView™ Documents*.

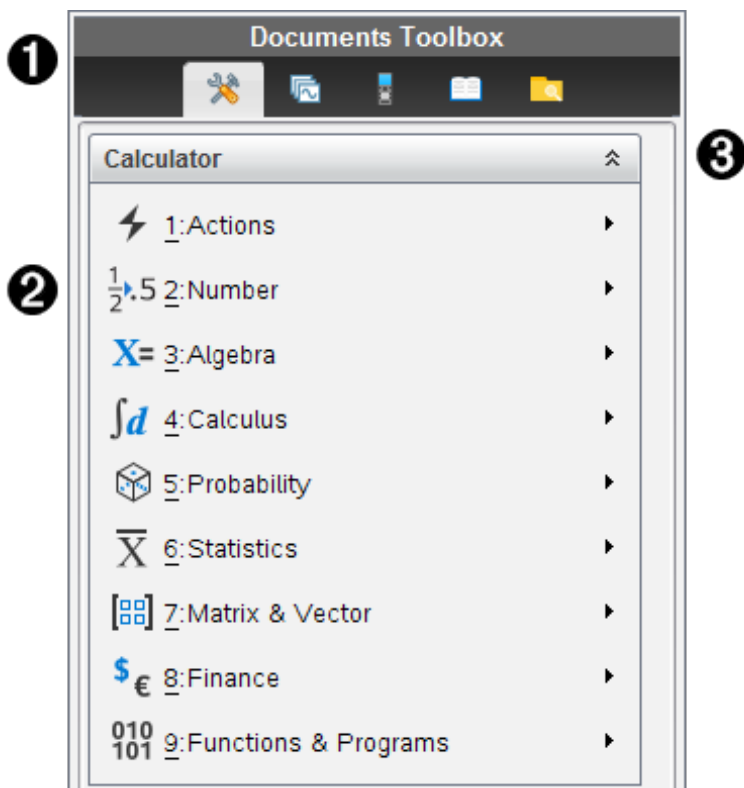

- 1 The Documents Toolbox menu.
- 2 Tools available for the Calculator application. Click ▶ to open the submenu for each option.

- 3 Click  to close and click  to open Document Tools.

## Exploring the Page Sorter

The following example shows the Documents Toolbox with the Page Sorter open. Use the Page Sorter to:

- See the number of problems in your document and where you are.
- Move from one page to another by clicking the page you want.
- Add, cut, copy, and paste pages and problems within the same document or between documents.

**Note:** When you are working in a PublishView™ document, the Page Sorter is not available in the Documents Toolbox.

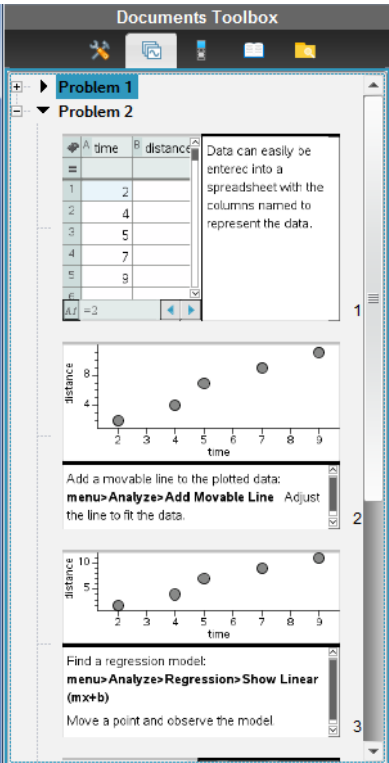

The screenshot shows the Documents Toolbox interface. At the top, the 'Documents Toolbox' menu is visible. Below it, the Page Sorter is expanded to show 'Problem 2'. The Page Sorter contains a table of data, a scatter plot, and a regression model. The table has columns for 'time' and 'distance'. The scatter plot shows the relationship between time and distance. The regression model shows the equation  $mx+b$ .

time	distance
2	2
4	4
5	5
7	7
9	9

Distance vs. Time Data:

time	distance
2	2
4	4
5	5
7	7
9	9

Regression Model:

$$y = mx + b$$

- 1 The Documents Toolbox menu.
- 2 Click the minus sign to collapse the view. Click the + sign to open the view and show pages in the document.



- ③ Scroll bar. The scroll bar is only active when there are too many pages to show in the pane.

## ***Exploring the TI-SmartView™ Feature***

The TI-SmartView™ feature emulates how a handheld works. In the teacher software, the emulated handheld facilitates classroom presentations. In the student software, the emulated keypad gives students the ability to drive the software as if using a handheld.

**Note:** Content is displayed on the TI-SmartView™ small screen only when the document is in Handheld view.

When working in a PublishView™ document, TI-SmartView™ emulator is not available.

**Note:** The following illustration shows the TI-SmartView™ panel in the teacher software. In the Student Software, only the keypad is shown. For more information, see Using the TI-SmartView™ Emulator.

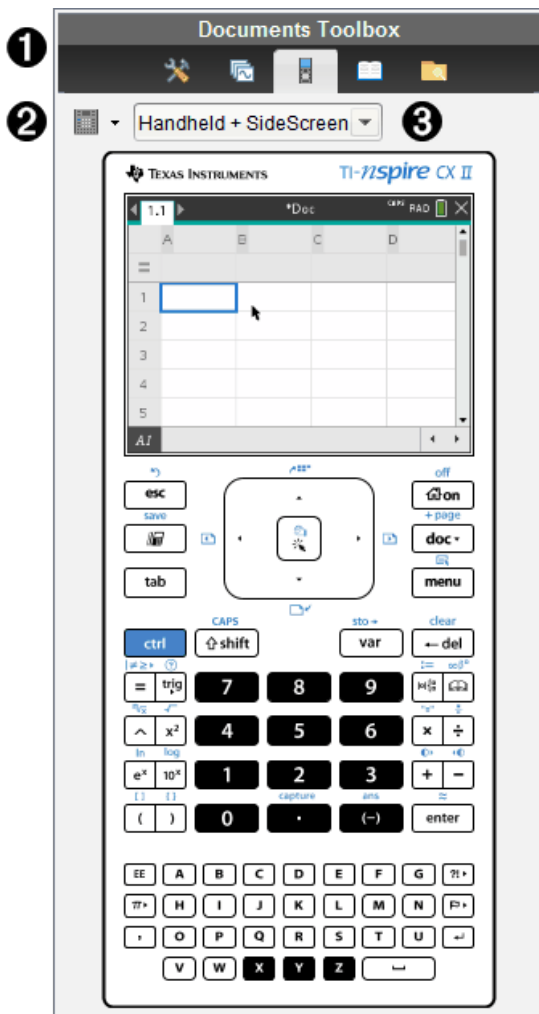

- 1 The Documents Toolbox menu.
- 2 Keypad Options. Click ▼ to select how to show the handheld:
  - Dark
  - Light
  - Outline
- 3 View selector. In the teacher software, click ▼ to select the handheld view:
  - Handheld Only

- Keypad + SideScreen
- Handheld + SideScreen

**Note:** You can also change these options in the TI-SmartView™ Options window. Click **File > Settings > TI-Smartview™ Options** to open the window.

**Note:** The view selector is not available in the student software.

When the Handheld Only display is active, select **Always in Front** to keep the display in front of all other open applications. (Teacher software only.)

## ***Exploring Content Explorer***

Use Content Explorer to:

- See a list of files on your computer.
- Create and manage lesson bundles.
- If using software that supports connected handhelds, you can:
  - See a list of files on any connected handheld.
  - Update the OS on connected handhelds.
  - Transfer files between a computer and connected handhelds.

**Note:** If you are using TI-Nspire™ software that does not support connected handhelds, the Connected Handheld heading is not shown in the Content Explorer pane.

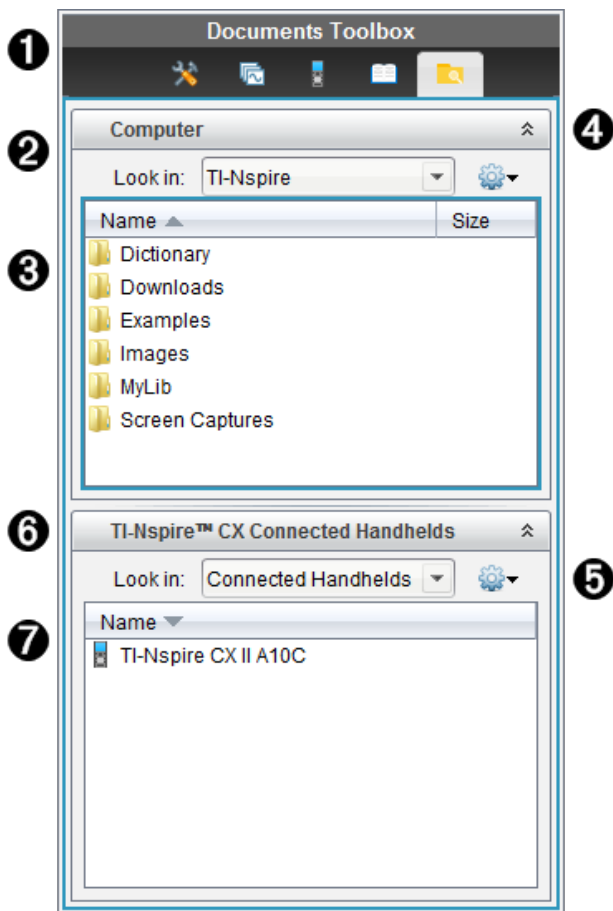

- 1 The Documents Toolbox menu.
- 2 Shows files on your computer and the name of the folder where the files are located. Click ▼ to navigate to another folder on the computer.
- 3 The list of folders and files within the folder named in the **Look In:** field. Right-click on a highlighted file or folder to open the context menu listing available actions for that file or folder.
- 4 Click ⤴ to close the list of files. Click ⤵ to open the list of files.
- 5  Options menu. Click ▼ to open the menu of actions you can perform on a selected file:
  - Open an existing file or folder.
  - Move (navigate) up one level in the folder hierarchy.

- Create a new folder.
  - Create a new lesson bundle.
  - Rename a file or folder.
  - Copy selected file or folder.
  - Paste file or folder copied to Clipboard.
  - Delete selected file or folder.
  - Select all files in a folder.
  - Package lesson bundles.
  - Refresh the view.
  - Install OS.
- ⑥ Connected handhelds. Lists the connected handhelds. Multiple handhelds are listed if more than one handheld is connected to the computer or when using the TI-Nspire™ Docking Stations.
- ⑦ The name of the connected handheld. To show the folders and files on a handheld, double-click the name.
- Click ▼ to navigate to another folder on the handheld.

## ***Exploring Utilities***

Utilities provides access to the math templates and operators, special symbols, catalog items, and libraries that you need when working with documents. In the following example, the Math templates tab is open.

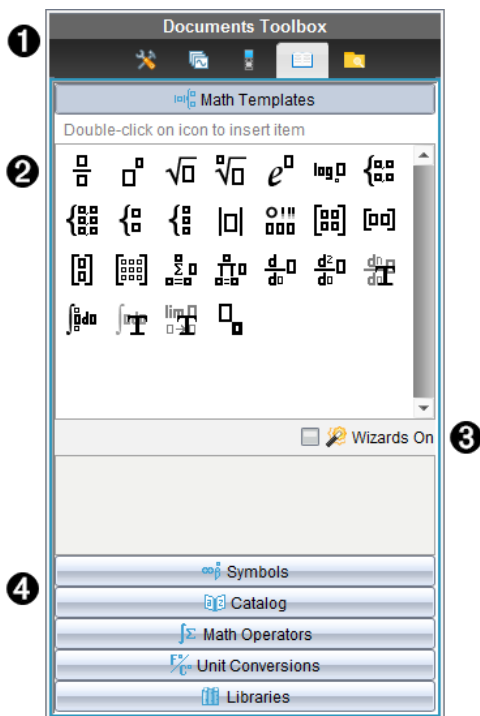

- 1 The Documents Toolbox menu.
- 2 Math Templates are open. Double-click a template to add it to a document. Click the Math Template tab to close the template view.  
To open the Symbols, Catalog, Math Operators, and Libraries, click the tab.
- 3 Wizards On check box. Select this option to use a wizard to enter function arguments.
- 4 Tabs for opening views where you can select and add symbols, catalog items, math operators, and library items to a document. Click the tab to open the view.

## Using the Work Area

The space on the right side of the workspace provides an area for creating and working with TI-Nspire™ and PublishView™ documents. This work area provides a view of the document so that you can add pages, add applications, and perform all work. Only one document at a time is active.

When you create a document, you specify its page size as Handheld or Computer. This is how the page is displayed in the work area.

- **Handheld** page size is optimized for the smaller screen of a handheld. This page size can be viewed on handhelds, computer screens, and tablets. The content is scaled when viewed on a larger screen.
- **Computer** page size takes advantage of the larger space of a computer screen. These documents can show details with less scrolling required. The content is not scaled when viewed on a handheld.

You can change the page preview to see how the document will look in a different page size.

- To change the page preview, click **Document Preview** on the toolbar, and then click **Handheld** or **Computer**.



For more information on page size and document preview, see *Working with TI-Nspire™ Documents*.

## Changing Document Settings

Document settings control how all numbers, including elements or matrices and lists, are displayed in TI-Nspire™ and PublishView™ documents. You can change the default settings at anytime and you can specify settings for a specific document.

### Changing Document Settings

1. Create a new document or open an existing document.
2. From the TI-Nspire™ **File** menu, select **Settings > Document Settings**.

The Document Settings dialog box opens.

When you open Document Settings the first time, the default settings are displayed.

3. Press **Tab** or use your mouse to move through the list of settings. Click ▼ to open the drop-down list to view the available values for each setting.

Field	Values
Display Digits	<ul style="list-style-type: none"> <li>• Float</li> <li>• Float1 - Float12</li> <li>• Fix0 - Fix12</li> </ul>
Angle	<ul style="list-style-type: none"> <li>• Radian</li> <li>• Degree</li> <li>• Gradian</li> </ul>
Exponential Format	<ul style="list-style-type: none"> <li>• Normal</li> </ul>

Field	Values
	<ul style="list-style-type: none"> <li>• Scientific</li> <li>• Engineering</li> </ul>
Real or Complex	<ul style="list-style-type: none"> <li>• Real</li> <li>• Rectangular</li> <li>• Polar</li> </ul>
Calculation Mode	<ul style="list-style-type: none"> <li>• Auto</li> <li>• Exact</li> <li>• Approximate</li> </ul> <p><b>Note:</b> Auto mode shows an answer that is not a whole number as a fraction except when a decimal is used in the problem. Exact mode (CAS only) shows an answer that is not a whole number as a fraction or in symbolic form, except when a decimal is used in the problem.</p>
Exact Arithmetic	<ul style="list-style-type: none"> <li>• On</li> <li>• Off</li> </ul> <p><b>Note:</b> This option is only available on Exact Arithmetic handhelds.</p>
CAS Mode	<ul style="list-style-type: none"> <li>• On</li> <li>• Exact Arithmetic</li> <li>• Off</li> </ul> <p><b>Note:</b> This option is only available on CAS handhelds and software.</p>
Vector Format	<ul style="list-style-type: none"> <li>• Rectangular</li> <li>• Cylindrical</li> <li>• Spherical</li> </ul>
Base	<ul style="list-style-type: none"> <li>• Decimal</li> <li>• Hex</li> <li>• Binary</li> </ul>
Unit System	<ul style="list-style-type: none"> <li>• SI</li> <li>• Eng/US</li> </ul> <p><b>Note:</b> This option is only available on CAS handhelds and software.</p>

4. Click the desired setting.

5. Choose one of the following options:

- To apply the settings to the open document and to Scratchpad, and to make default for new applications, click **OK**.
- Click **Cancel** to close the dialog box without making changes.



## Changing Graphs & Geometry Settings

Graphs & Geometry settings control how information is displayed in open problems and in subsequent new problems. When you change the Graphs & Geometry settings, the selections become the default settings for all work in these applications.

Complete the following steps to customize the application settings for graphs and geometry.

1. Create a new graphs and geometry document or open an existing document.
2. In the Documents Toolbox, click  to open the Graphs & Geometry application menu.
3. Click **Settings > Settings**.

The Graphs & Geometry Settings dialog box opens.

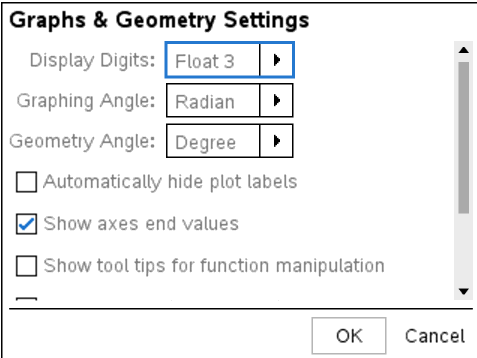

**Graphs & Geometry Settings**

Display Digits:  ▾

Graphing Angle:  ▾

Geometry Angle:  ▾

Automatically hide plot labels

Show axes end values

Show tool tips for function manipulation

OK Cancel

4. Press **Tab** or use your mouse to move through the list of settings. Click ▸ to open the drop-down list to view the available values for each setting.

Field	Values
Display Digits	<ul style="list-style-type: none"><li>• Auto</li><li>• Float</li><li>• Float1 - Float12</li><li>• Fix0 - Fix12</li></ul>
Graphing Angle	<ul style="list-style-type: none"><li>• Auto</li><li>• Radian</li><li>• Degree</li><li>• Gradian</li></ul>
Geometry Angle	<ul style="list-style-type: none"><li>• Auto</li><li>• Radian</li><li>• Degree</li><li>• Gradian</li></ul>

5. Select the desired setting.
6. Select a check box to enable an option or clear a check box to disable an option.

Check box	Operation when selected
Automatically hide plot labels	Plot labels are displayed only when selected, grabbed, or hovered.
Show axis end values	A numeric label is displayed at the least and greatest values visible on an axis
Show tool tips for function manipulation	Shows helpful information as you manipulate function graphs
Automatically find a point of interest	Shows zeros, minima, and maxima for graphed functions and objects while tracing function graphs.

7. Choose one of the following options:
  - To apply the settings to the open document and to Scratchpad, and to make default for new Graphs and Geometry applications, click **OK**.
  - Click **Cancel** to close the dialog box without making changes.

## Working with Connected Handhelds

The TI-Nspire™ software enables you to view content, manage files, and install operating system updates on handhelds connected to the computer.

To use the features described in this chapter, handhelds must be turned on and connected by one of these means:

- TI-Nspire™ Docking Station or TI-Nspire™ CX Docking Station
- TI-Nspire™ Navigator™ Cradle and access point
- TI-Nspire™ CX Wireless Network Adapter and access point
- TI-Nspire™ CX Wireless Network Adapter - v2 and access point
- A direct connection through a standard USB cable

For web-based connectivity using your TI-Nspire™ CX II with a Chromebook, Windows® computer, or Mac® computer, go to [TI-Nspire™ CX II Connect](#).

**Note:** The tasks in this section can only be performed using TI-Nspire™ handhelds. In order to enable wireless connectivity, the TI-Nspire™ Premium Teacher Software and the OS installed on the TI-Nspire™ CX II handhelds must be version 5.0 or later. For TI-Nspire™ CX handhelds, the OS must be version 4.0 or later.

### *Managing Files on a Connected Handheld*

When working with files on connected handhelds in the Content Workspace, use the Options menu  or the context menu to manage files.

**Note:** If you select a file type that is not supported on the handheld, some selections in Options menu are not active.

Option	How it Works
Open	Open a file on a connected handheld: <ul style="list-style-type: none"><li>• Click the file you want to open.</li><li>• Click <b>Open</b>. The document opens in the Documents Workspace.</li></ul>
Save to Computer	Save a copy of the selected file on your computer: <ul style="list-style-type: none"><li>• Click the file you want to save.</li><li>• Click <b>Save to Computer</b>. The Save Selected Files dialog box opens.</li><li>• Navigate to the folder where you want to save the file.</li><li>• Click <b>Save</b>.</li></ul>
Copy/Paste	Create a copy of a file: <ul style="list-style-type: none"><li>• Click the file you want to copy.</li><li>• Click <b>Options &gt; Copy</b> to copy the file to the Clipboard.</li></ul>

Option	How it Works
	<ul style="list-style-type: none"> <li>To paste the file in another location, navigate to the new location, and then click <b>Options &gt; Paste</b>.</li> </ul> <p><b>Note:</b> If you don't select a new location, the copied file is pasted with a new name "Copy of ..."</p>
Delete	Delete a file on a connected handheld: <ul style="list-style-type: none"> <li>Click the file you want to delete.</li> <li>Click <b>Delete</b>.</li> <li>Click <b>Yes</b> when the Warning dialog box opens. Click <b>No</b> to cancel.</li> </ul>
Refresh	To refresh the list of files, click <b>Options &gt; Refresh</b> .
Rename	To rename a file on a connected handheld: <ul style="list-style-type: none"> <li>Click the file you want to rename.</li> <li>Click <b>Options &gt; Rename</b>.</li> <li>Type the new name and press <b>Enter</b>.</li> </ul>
Up a Level	Go up a level in the folder hierarchy. This option is available when you select a file inside a folder.
New Folder	Create a new folder: <ul style="list-style-type: none"> <li>Click <b>New Folder</b>.</li> <li>Type a name for the new folder.</li> <li>Press <b>Enter</b>.</li> </ul>

### Opening Documents on a Connected Handheld

To open a document on a connected handheld in the TI-Nspire™ software:

1. Ensure the handheld is connected to your computer.
2. Click  to open Content Explorer.

The connected handheld name is listed in the Connected Handhelds pane.

3. Double-click the handheld name.

The folders and documents on the handheld are listed.

4. Navigate to the document you want to open, and then double-click the file name.

The document opens in the Documents Workspace.

### Saving Files to a Connected Handheld

When you save a file from your computer to a handheld, files are converted to TI-Nspire™ documents (.tns files). (See *Sending Files to Handhelds*)

To save a file on your computer to a connected handheld:

1. Ensure the handheld is connected to your computer.
2. Click  to open Content Explorer.

The folders and files on your computer are listed in the Computer pane.

3. Navigate to the folder or file you want to save to the handheld.
4. Click the file to select it.
5. Drag the file to a connected handheld listed in the Connected Handheld pane.

The file is saved to the connected handheld.

**Note:** To save the file in a folder on the handheld, double-click the handheld name to list the folders and files, and then drag the file to a folder on the handheld.

If the file already exists on the handheld, a dialog box opens asking if you want to replace the file. Click **Replace** to overwrite the existing file. Click **No** or **Cancel** to abandon the save.

## Checking for an OS Update

When handhelds are connected, you can check for OS updates from the Content Workspace or from the Documents Workspace.

**Note:** Your computer must be connected to the Internet.

1. Show all connected handhelds.
  - In the Content Workspace, click **Connected Handhelds** in the Resources pane.
  - In the Documents Workspace, open the Content Explorer and click **Connected Handhelds**.
2. Click the handheld you want to check, and then right-click and select **Check for OS Update**.
  - If the operating system is current, the Check for Handheld OS Update dialog box opens indicating that the operating system on the handheld is current.

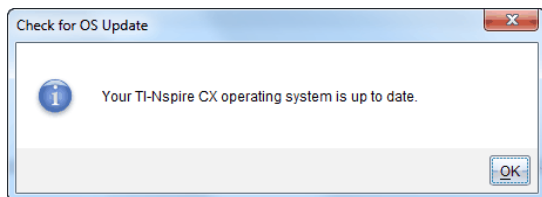

- If the operating system is not current, the TI-Nspire™ software prompts you to install the latest OS now, with the option to download the OS to your computer.

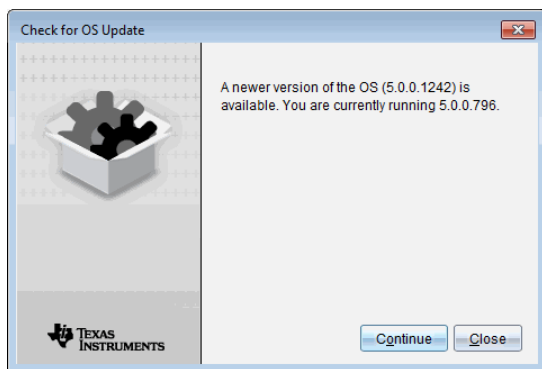

3. Click **Close** to close the dialog box, or click **Continue** and follow the prompts to install the OS on the handheld.

### ***Installing an OS Update***

**Note:** To avoid losing unsaved data, close all documents on the handheld before updating its operating system (OS). Updating the OS does not replace or remove previously saved documents.

The OS on a new handheld comes bundled with the installer, which places the OS in a default location such as: C:\mydocuments\TI-Nspire\downloads.

Go to [education.ti.com/latest](http://education.ti.com/latest) to download the latest OS files.

**Note:** You can install OS updates on connected handhelds from the Content Workspace at any time.

### **Updating the OS on a Single Handheld**

1. Ensure that your computer is connected to the internet.
2. Show all connected handhelds by clicking the arrow next to **TI-Nspire™ Connected Handhelds** in the Resources pane.

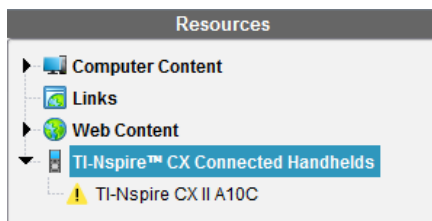

**Note:** An attention  symbol next to a handheld name means:

The handheld needs an OS update.

—or—

The handheld has a newer OS than the teacher's.

3. Hover your mouse over the TI-Nspire™ handheld you want to update, and then right-click.
4. Click **Check for OS Update**.

The Check for OS Update dialog box opens.

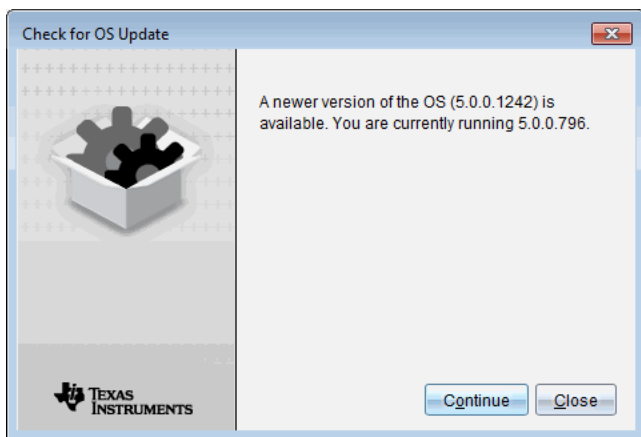

5. Click **Close** to cancel the installation, or click **Continue** and follow the prompts to install the OS on the handheld.

When the update is complete, the handheld restarts automatically.

### Updating the OS on Multiple Handhelds

**Note:** To avoid losing unsaved data, close all documents on the handheld before updating its operating system (OS). Updating the OS does not replace or remove previously saved documents.

1. Click **TI-Nspire™ Connected Handhelds** in the Resources pane.
2. Select all handhelds you want to update in the Content Pane.
3. Click **Tools > Install OS**.

The OS Installation dialog box opens.

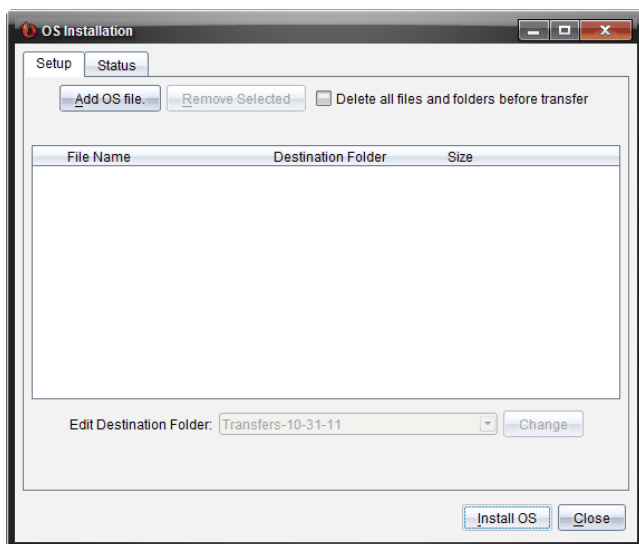

4. Click **Add OS file**.

The Add to Transfer List dialog box opens.

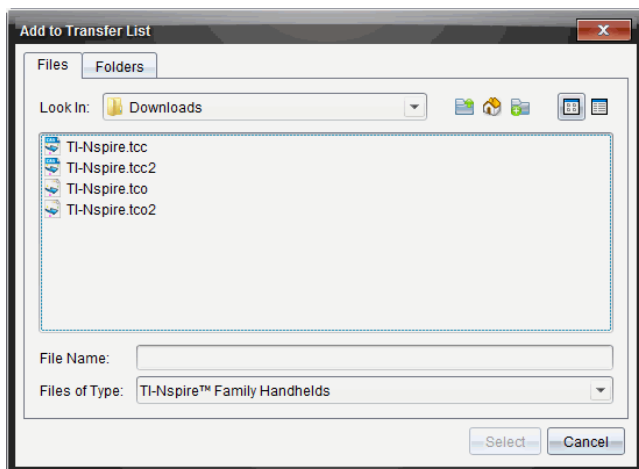

5. Select the applicable OS files.

- To upgrade a TI-Nspire™ CX handheld, select TI-Nspire.tco.
- To upgrade a TI-Nspire™ CX CAS handheld, select TI-Nspire.tcc.
- To upgrade a TI-Nspire™ CX II handheld, select TI-Nspire.tco2.



- To upgrade a TI-Nspire™ CX II CAS handheld, select TI-Nspire.tcc2.
- To upgrade a TI-Nspire™ CX II-T handheld, select TI-Nspire.tct2.

6. Click **Select**.

The OS Installation redisplays with your selected OS files.

7. Click **Install OS**.

The OS version information updates, and the Select OS Handheld File dialog redisplays for further selection.

# Working with TI-Nspire™ Documents

All work that you create and save using TI-Nspire™ applications is stored as a document, which you can share with others using TI-Nspire™ software and with those using handhelds. There are two types of documents:

- TI-Nspire™ document (.tns file)
- PublishView™ document (.tnsp file)

## TI-Nspire™ Documents

A TI-Nspire™ document consists of one or more problems. Each problem can contain one or more pages. A single page is displayed in the work area. All work occurs in the applications within pages.

Because the TI-Nspire™ software and handhelds share the same functionality, you can transfer TI-Nspire™ documents between computers and handhelds. When you create a document, you select one of two page sizes.

- **Handheld.** Size: 320 × 217 pixels. This size allows documents to be viewed on all platforms. The content will be scaled when viewed on a tablet or larger screen.
- **Computer.** Size: 640 × 434 pixels. The content will not be scaled when viewed on smaller platforms. Some content may not be visible on a handheld device.

You can convert a document from one page size to the other anytime.

## PublishView™ Documents

PublishView™ documents can be printed on a standard piece of paper or published to a website or blog. PublishView™ documents can include formatted text, images, and hyperlinks as well as all TI-Nspire™ applications.

For more information, see *Working with PublishView™ Documents*.

## Creating a New TI-Nspire™ Document

When you open the software, the Documents Workspace opens with a blank document containing one problem. You can add applications and content to this problem to create a document.

**Note:** The Welcome Screen is displayed when you open the software if the "always show this at startup" option is selected. Click an application icon to add a problem with an active application to a new document.

To create a new document, complete the following steps:

1. On the TI-Nspire™ **File** menu,
  - Select **New TI-Nspire™ Document - Handheld Page Size**.
  - or —
  - Select **New TI-Nspire™ Document - Computer Page Size**.

The new document opens in the Documents Workspace, and you are prompted to select an application.

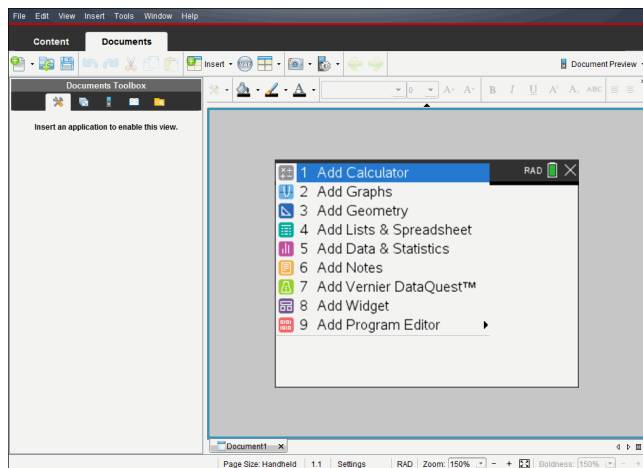

2. Select an application to add a problem to the document.

The problem is added to the document.

### ***Opening an Existing Document***

To open an existing document:

1. Click **File > Open Document**.

—or—

Click  .

The Open dialog box opens.

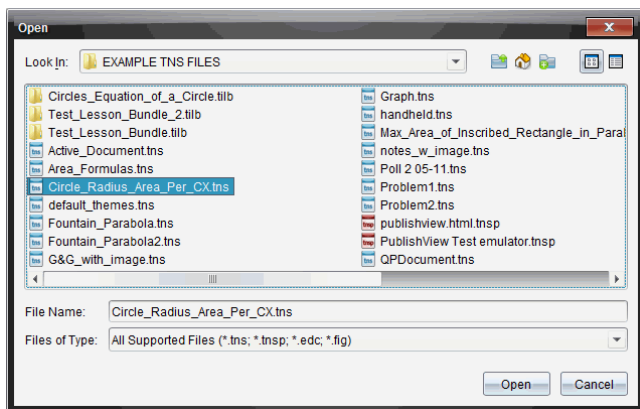

2. Use the file browser to locate the file you want to open and click the file to select it.
3. Click **Open**.

The document opens in the work area.

**Note:** To select from your 10 most recent documents, click **File > Recent Documents** and select a document from the drop-down list.

## ***Saving TI-Nspire™ Documents***

To save a new document:

1. Click **File > Save Document** or click .

The Save TI-Nspire™ Document dialog box opens.

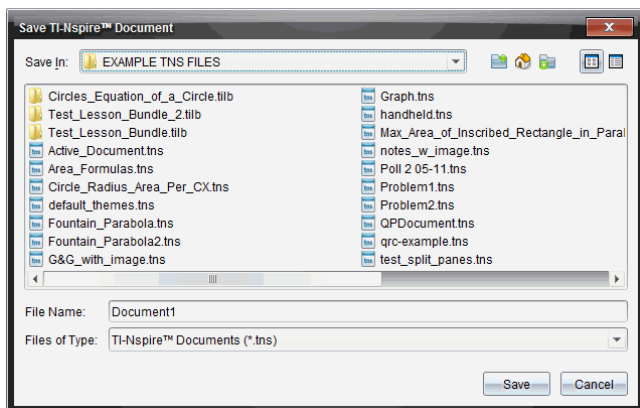

2. Navigate to the folder where you want to save the document or create a folder in which to store the document.

3. Type a name for the new document.
4. Click **Save** to save the document.

The document closes and is saved with the extension .tns.

**Note:** When you save a file, the software looks in the same folder the next time you open a file.

### **Saving a Document with a New Name**

To save a previously saved document in a new folder and/or with a new name:

1. Click **File > Save As**.

The Save TI-Nspire™ Document dialog box opens.

2. Navigate to the folder where you want to save the document or create a folder in which to store the document.
3. Type a new name for the document.
4. Click **Save** to save the document with a new name.

### **Deleting Documents**

File deletions on your computer are sent to the Recycle bin and can be retrieved if the Recycle bin has not been emptied.

**Note:** File deletions on the handheld are permanent and cannot be undone, so be sure that you want to delete the file that you select.

1. Select the document you want to delete.
2. Click **Edit > Delete** or press **Delete**.

The Warning dialog box opens.

3. Click **Yes** to confirm the delete.

The document is deleted.

### **Closing Documents**

- ▶ To close a document, click **File > Close** or click the **Close** icon on the document tab at the bottom of the document.







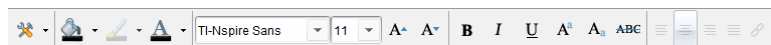

- ▶ If working in tiled view, click the **Close** icon in the upper right corner of the document window.

## Formatting Text in Documents

Use the text formatting tools to format text in TI-Nspire™ applications that allow formatted text, and to format text in PublishView™ documents. By default, the text formatting toolbar opens in the area above an active document. Options on the toolbar are enabled or disabled depending on the active application.

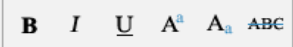

Option	Function
	Click ▼ to open the menu for the active application. This tool enables you to open an application menu regardless of the option selected in the Documents Toolbox.
	Click ▼ to select a background color for highlighting text or choose a fill color for a selected cell.
	Click ▼ to select the line color for an object. For example, in Graphs & Geometry, you can choose a color for a selected shape.
	Click ▼ to select a color for selected text.
	Use these tools to choose a font and set the size of the font. <ul style="list-style-type: none"> <li>Click ▼ to select a different font from the drop-down box.</li> <li>To select a specific font size, click ▼ to select a size from the drop-down box.</li> <li>Click <b>A<sup>+</sup></b> to increase the font size or click <b>A<sub>-</sub></b> to decrease the font size incrementally.</li> </ul>
	Click the appropriate tool to apply bolding, italics, or underlining; apply superscript or subscript; or strike out text.
	In a PublishView™ document, use these tools to position text within the header or footer, or in text box. Clicking  opens the Hyperlink dialog box.

Option	Function
	For more information, see <i>Working with PublishView™ Documents</i> .

### Hiding and Showing the Formatting Toolbar

- ▶ When the formatting toolbar is visible, click ▲ (located under the toolbar) to hide the toolbar.
- ▶ Click ▼ to show the toolbar when the formatting toolbar is hidden.

### Using Colors in Documents

In the TI-Nspire™ applications that allow formatting, you can use color in filled areas of an object, or in lines or text, depending on the application you are using and how you have selected the item. If the icon or menu item that you want to use is not available (dimmed) after you have selected an item, color is not an option for the selected item.

Colors appear in documents opened on your computer and on the TI-Nspire™ CX handheld. If a document containing color is opened on a TI-Nspire™ handheld, colors are displayed in shades of gray.

**Note:** For more information about using color in a TI-Nspire™ application, see the chapter for that application.

#### Adding Color from a List

To add color to a fill area, line, or text, complete the following steps:

1. Select the item.
2. Click **Edit > Color** or select where you want to add color (fill, line, or text).
3. Select the color from the list.

#### Adding Color from a Palette

To add color using the palette, complete the following steps:

1. Select the object.
2. Click the appropriate toolbar icon.
3. Select the color from the palette.

### Setting Page Size and Document Preview

When you create a document, you specify its page size as Handheld or Computer, depending on how you expect the document to be used. Documents of both page sizes can be opened on either platform, and you can convert the page size anytime.

- **Handheld.** Size: 320 × 217 pixels, fixed. Handheld documents can be viewed on all platforms. You can magnify (zoom) the content when viewing it on a tablet or larger screen.

- **Computer.** Size: 640 × 434 pixels, minimum. Computer documents scale up automatically to take advantage of higher resolution screens. The minimum size is 640 × 434, so some content may be clipped on handheld devices.

**Note:** You can view documents of either page size using Handheld or Computer preview.

### Converting the Current Document's Page Size

- ▶ On the main TI-Nspire™ **File** menu, select **Convert to**, and then select the page size.  
The software saves the current document and creates a copy that uses the requested page size.

### Viewing the Document in Handheld Preview

1. On the application toolbar, click **Document Preview**, and select **Handheld**.  
The preview changes. This does not change the document's underlying page size.
2. (Optional) Adjust the viewing magnification:
  - Click the **Zoom** tool beneath the work area, and select a magnification value.  
—or—
  - Click the **Zoom to Fit** button  to make the handheld preview adjust automatically to the window size.

### Viewing the Document in Computer Preview

1. On the application toolbar, click **Document Preview**, and select **Computer**.  
The preview changes. This does not change the document's underlying page size.
2. (Optional) Click the **Boldness** tool beneath the work area, and select a value to increase or decrease the boldness of text and other items.

### Setting the Default Page Size for New Documents

1. On the main TI-Nspire™ **File** menu, select **Settings > Page Size Settings**.
2. Select a default page size, either Handheld or Computer.

The new size applies to documents that you create (Windows®: **Ctrl+C**, Mac®: **Cmd+C**) after setting the default, including the blank document created automatically each time you open the software. Changing the default setting does not convert any currently open documents or other existing documents.



## Setting a Default Preview

By default, when you open a document, it is automatically displayed using the preview that matches its page size. You can override this rule and specify a preview that you prefer.

1. On the main TI-Nspire™ **File** menu, select **Settings > Preview Settings**.
2. Select the preview that you want documents to use when you open them.

## Working with Multiple Documents

When multiple documents are open, document names are listed in tabs at the bottom of the work area. Only one document is active at a time, and only the active document is affected by commands from menus or tools.

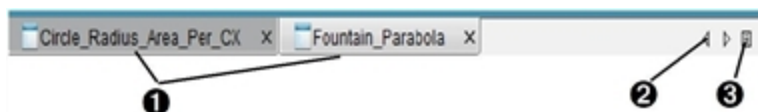

To switch between documents:

1. Click the tab to show a document in the work area. This document becomes the active document. If the Show Documents in Tiles view is open, these tabs are not shown.
2. Use the right and left arrows to scroll through the list of documents. These arrows are active only when there are too many documents to fit in the window.
3. Click the Show List icon to list all open documents. This is useful when you have a large number of documents open and documents names on the tabs may be truncated.

## Working with Multiple Documents in Tiled View

When multiple documents are open, you can view thumbnails of the documents in the work area. To change the view:

- ▶ Click **Window > Show Documents in Tiles**.

Open documents are shown as thumbnails in the work area, and the scroll bar becomes active.

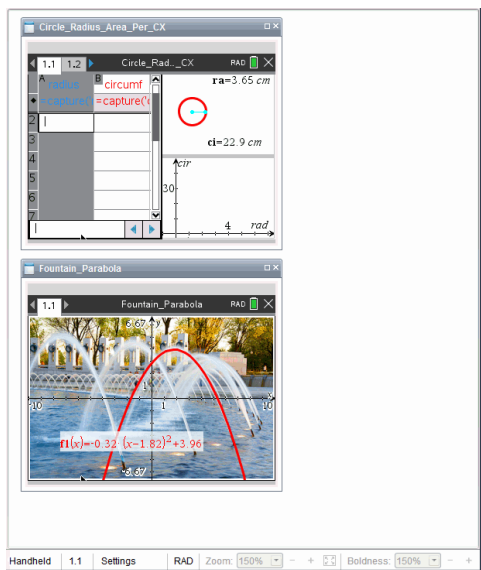



The status bar remains available; however, document names now appear in the thumbnail view. Click **Select Window > Show Documents in Tabs** to view one document at a time in the work area.

### ***Working with Applications***

When you first open a new document or add a new problem to a document, you select an application from a menu.

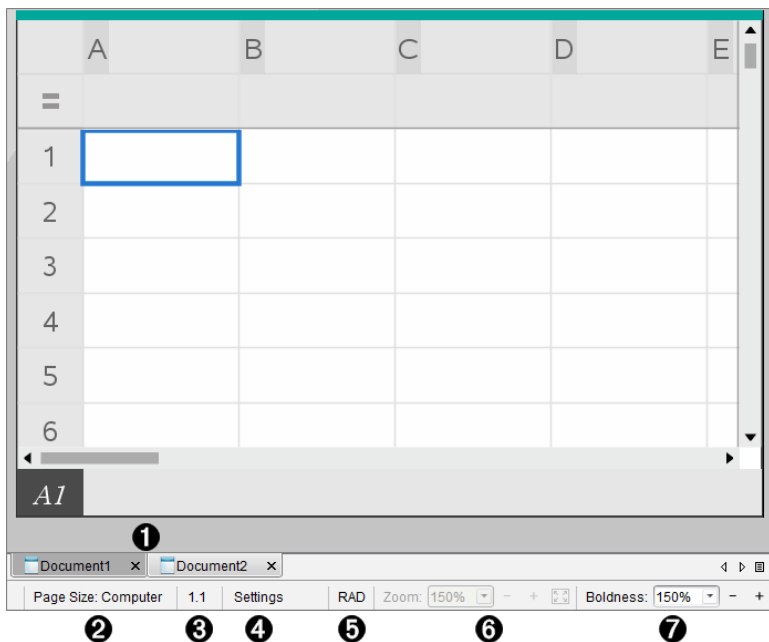
The following illustration shows how a document containing the Lists & Spreadsheet application appears in the work area.



- 1 **Document name.** Tabs show the names of open documents. Click a name to make it the active document.
- 2 **Page Size.** Shows the document's page size as Handheld or Computer. You can use the TI-Nspire™ **File** menu to convert a document from one page size to the other.
- 3 **Problem/Page counter.** Labels the problem number and page number of the active page. For example, a label of **1.2** identifies Problem **1**, Page **2**.
- 4 **Settings.** Double-click to view or change the Document Settings for the active document or to change the default Document Settings.
- 5 **Angle Mode.** Shows an abbreviation of the angle mode (Degrees, Radians, or Gradians) in effect. Hover the pointer over the indicator to see the full name.
- 6 **Zoom.** Enabled in Handheld preview only (click **Document Preview** on the toolbar and select **Handheld**). Click ▼ and select a magnification value, or click the zoom-to-fit button  to make the preview adapt automatically to window size.
- 7 **Boldness.** Enabled in Computer preview only (click **Document Preview** on the toolbar and select **Computer**). Click ▼ and select a value to increase or decrease the boldness of text and other items.

### Working with Multiple Applications on a Page

You can add up to four applications to a page. When you have multiple applications on a page, the menu for the active application is displayed in the Documents Toolbox. Using multiple applications involves two steps:

- Changing the page layout to accommodate multiple applications.

- Adding the applications.

You can add multiple applications to a page even if an application is already active.

### Adding Multiple Applications to a Page

By default, each page contains space to add one application. To add additional applications to the page, complete the following steps.

1. Click **Edit > Page Layout > Select Layout**.

—or—

Click  .

The page layout menu opens.



There are eight page layout options available. If an option is already selected, it is dimmed.

2. Highlight the layout you want to add to the problem or page, and then click to select it.

The new layout is displayed with the first application active.

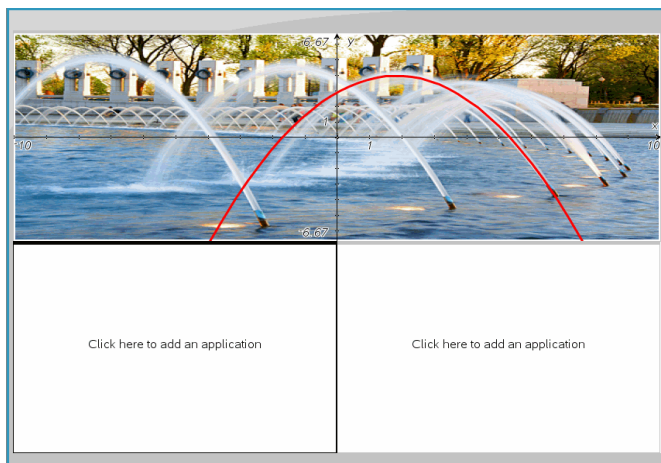

3. In Handheld preview, click **Press menu** to select an application for each new section in the problem or page. In Computer view, select **Click here to add an application**.

### Swapping Applications

To change the position of applications on a page with multiple applications, “swap” the positions of two applications.

1. Click **Edit > Page Layout > Swap Application**.

**Note:** The last active application you worked on is automatically selected as the first application to be swapped.

2. Click the second application to swap.

This action performs the swap.

**Note:** When there are only two work areas, the selected application automatically swaps position with the other application in the work area.

To cancel a swap, press **Esc**.

### Selecting and Moving Pages

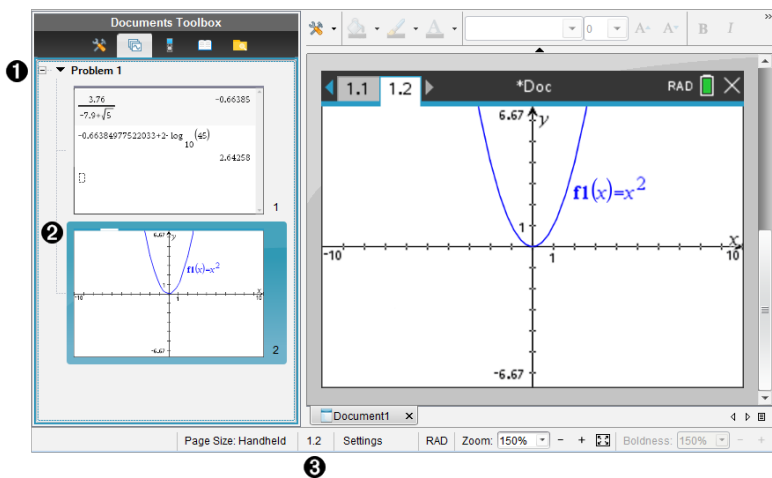

As you add problems and pages to a document, you can take advantage of features for managing the parts.



- 1 **Page Sorter.** Lists the problems you have inserted in your document and shows thumbnail images of the pages in each problem. The Page Sorter lets you rearrange, copy, and move both problems and pages. It also lets you rename problems.
- 2 **Active page.** Indicates the current page by highlighting its thumbnail image. Thumbnails let you easily scan the pages in a document and select a specific page to work with.
- 3 **Problem/Page counter.** Displays the problem number and page number of the currently selected page.

## Selecting Pages

Use any of these methods to move from page to page.

- ▶ On the **View** menu, select **Previous Page** or **Next Page**.
- ▶ On the keyboard, press **Ctrl+PgUp** or **Ctrl+PgDn**.  
(Mac®: Press **Fn+Up Arrow** or **Fn+Down Arrow**).
- ▶ Click the Previous Page  or Next Page  button on the main toolbar.
- ▶ Click the Page Sorter tool  in the Documents Toolbox, and then click the thumbnail of the page you want to work with.

**Tip:** To expand or collapse the list of thumbnails for a problem, double-click the name of the problem.

## Rearranging Pages with the Page Sorter

The Page Sorter makes it easy to reorder pages within a problem.

1. If necessary, click the Page Sorter tool  in the Documents Toolbox.
2. In the Page Sorter, drag the thumbnail image of the page to the desired position.

### Copying a Page

You can copy a page within the same problem or copy it to a different problem or document.

1. If necessary, click the Page Sorter tool  in the Documents Toolbox.
2. Select the thumbnail of the page to be copied.
3. On the **Edit** menu, click **Copy**.
4. Click the location at which you want to insert the copy.
5. On the **Edit** menu, click **Paste**.

### Moving a Page

You can move a page within the same problem or move it to a different problem or document.

1. If necessary, click the Page Sorter tool  in the Documents Toolbox.
2. Select the thumbnail of the page to be moved.
3. On the **Edit** menu, click **Cut**.
4. Click the new location of the page.
5. On the **Edit** menu, click **Paste**.

### Deleting a Page

1. Select the page in the work area or in the Page Sorter.
2. Click **Edit > Delete**.

### Grouping Applications on a Page

You can combine as many as four consecutive application pages into a single page.

1. Select the first page in the series.
2. Click **Edit > Page Layout > Group**.

The next page is grouped with the first page. The page layout automatically adjusts to display all the pages in the group.

## Ungrouping Applications into Separate Pages

1. Select the grouped page.
2. Click **Edit > Page Layout > Ungroup**.

The applications are divided into individual pages.

## Deleting an Application from a Page

1. Click the application to be deleted.
2. Click **Edit > Page Layout > Delete Application**.

**Tip:** To undo the delete, press **Ctrl + Z** (Mac®: **⌘ + Z**).

## Working with Problems and Pages

When you create a new document, it consists of a single problem with a single page. You can insert new problems and add pages to each problem.

### Adding a Problem to a Document

A document can contain up to 30 problems. Each problem's variables are unaffected by the variables in other problems.

- ▶ On the **Insert** menu, select **Problem**.

—or—

Click the Insert tool  on the main toolbar, and select **Problem**.

A new problem with an empty page is added to your document.

### Adding a Page to the Current Problem

Each problem can contain up to 50 pages. Each page has a work area, where you can perform calculations, create graphs, collect and plot data, or add notes and instructions.

1. Click **Insert > Page**.

—or—

Click the Insert tool  on the main toolbar, and select **Page**.

An empty page is added to the current problem, and you are prompted to choose an application for the page.

2. Select an application to add to the page.



## Renaming a Problem

New problems are named automatically as Problem 1, Problem 2, and so on. To rename a problem:

1. If necessary, click the Page Sorter tool  in the Documents Toolbox.
2. Click the problem name to select it.
3. On the **Edit** menu, click **Rename**.
4. Type the new name.

## Rearranging Problems with the Page Sorter

The Page Sorter lets you reorder problems within a document. If you move a problem that you have not renamed, the numeric part of the default name changes to reflect the new position.

1. If necessary, click the Page Sorter tool  in the Documents Toolbox.
2. In the Page Sorter, arrange the problems by dragging each problem name to its new position.

**Tip:** To collapse a problem's list of page thumbnails, double-click the name of the problem.

## Copying a Problem

You can copy a problem within the same document or copy it to a different document.

1. If necessary, click the Page Sorter tool  in the Documents Toolbox.
2. Click the problem name to select it.
3. On the **Edit** menu, click **Copy**.
4. Click the location at which you want to insert the copy.
5. On the **Edit** menu, click **Paste**.

## Moving a Problem

You can move a problem within the same document or move it to a different document.

1. If necessary, click the Page Sorter tool  in the Documents Toolbox.
2. Click the problem name to select it.
3. On the **Edit** menu, click **Cut**.

4. Click the new location of the problem.
5. On the **Edit** menu, click **Paste**.

### **Deleting a Problem**

To delete a problem and its pages from the document:

1. If necessary, click the Page Sorter tool  in the Documents Toolbox.
2. Click the problem name to select it.
3. On the **Edit** menu, click **Delete**.

### **Printing Documents**

1. Click **File > Print**.

The Print dialog box opens.

2. Set options for the print job.
  - **Printer** — Select from your list of available printers
  - **Print What:**
    - **Print All** — prints each page on a separate sheet
    - **Viewable Screen** — prints selected pages with additional layout options (see Layout, below)
  - **Print Range** — Click **All Pages**, or click **Page range** and set the starting and ending pages.
  - **Layout:**
    - **Orientation** (portrait or landscape)
    - The number of TI-Nspire™ pages (1, 2, 4, or 8) to be printed on each sheet (available in **Viewable Screen** option only). The default is 2 pages per sheet.
    - Whether to allow space below each printed TI-Nspire™ page for comments (available in **Viewable Screen** option only)
    - **Margins** (from .25 inches to 2 inches). The default margin is .5 inches on all edges.
  - **Documentation information to include:**
    - **Problem name**, including the option to group the pages physically by problem
    - **Page label** (such as 1.1 or 1.2) under each page
    - **Page header** (up to two lines)
    - **Document name** in the footer
3. Click **Print**, or click **Save As PDF**.

**Note:** To restore the Print defaults, click **Reset**.

## Using Print Preview

- Click the **Preview** check box to toggle the preview pane.
- Click the arrows at the bottom of the preview pane to page through the preview.

## Viewing Document Properties and Copyright Information

**Note:** Most of these instructions apply only to the Teacher Software.

### Checking Page Size

1. In the Teacher Software, go to the TI-Nspire™ **File** menu and select **Document Properties**.
2. Click the **Page Size** tab.
3. A checkmark indicates the document's current page size.

### Viewing Copyright Information

The Teacher Software and Student Software let you view copyright information that has been added to a document.

1. On the TI-Nspire™ **File** menu, select **View Copyright Information**.

The Copyright Information dialog box opens.

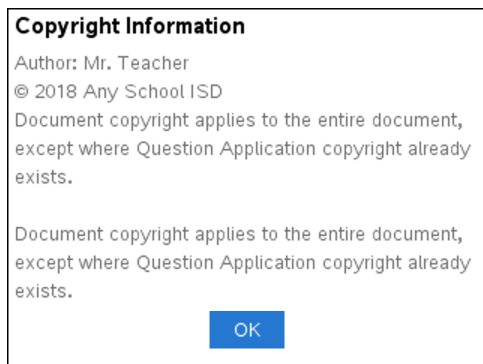

2. Click **OK** to close the dialog box.

### Adding Copyright Information to a Document

Using the Teacher Software, you can add copyright information to individual documents that you create, or you can apply the same copyright information to all new documents.

1. Open the document.

2. On the TI-Nspire™ **File** menu, select **Document Properties**.
3. Click the **Copyright** tab.
4. Edit the following fields to define the copyright details:
  - Author
  - Copyright (select Public Domain or Copyright).
  - Year (disabled if you selected Public Domain)
  - Owner (disabled if you selected Public Domain)
  - Comments
5. To add the supplied information to all new documents from this point forward, select **Apply this copyright to all new documents**.
6. Click **OK** to apply the copyright information to the document.

### **Protecting a Document (making a document read-only)**

Teachers can protect documents to create a document for distribution to your students or for other use. A student who receives a read-only document and makes changes to it will be prompted to save the document as a new file.

1. Open the document.
2. On the TI-Nspire™ **File** menu, select **Document Properties**.
3. Click the **Protection** tab.
4. Select the **Make this document Read Only** check box.
5. Click **OK**.

## Working with PublishView™ Documents

Use the PublishView™ feature to create and share interactive documents with teachers and students. You can create documents that include formatted text, TI-Nspire™ applications, images, hyperlinks, links to videos, and embedded videos in a format that is suitable for printing on a standard piece of paper, publishing to a website or blog, or for use as an interactive worksheet.

PublishView™ features provide layout and editing features for presenting math and science concepts in a document where TI-Nspire™ applications can be interactively and dynamically linked with supporting media, enabling you to bring the document to life. Using the PublishView™ feature:

- Teachers can create interactive activities and assessments used on screen.
- Teachers can create printed materials to complement documents used on TI-Nspire™ CX II handhelds.
- When working with lesson plans, teachers can:
  - Create lesson plans from existing handheld documents or convert lesson plans to handheld documents.
  - Link to related lesson plans or documents.
  - Embed explanatory text, images, video, and links to web resources.
  - Build or interact with TI-Nspire™ applications directly from the lesson plan.
- Students can create reports or projects such as lab reports containing data playback, curve fits, pictures, and video—all on the same sheet.
- Students can print and turn in assignments on a standard piece of paper.
- Students taking exams can use one tool to create a document that contains: all problems on the exam, text, images, hyperlinks, or videos, interactive TI-Nspire™ applications, screen shots, and layout options needed to print a document.

**Note:** PublishView™ documents can reside in the Portfolio Workspace, and TI-Nspire™ questions within a PublishView™ document can be automatically graded by the TI-Nspire™ Navigator™ system.

### Creating a New PublishView™ Document

1. From the Documents Workspace, click **File > New PublishView™ Document**.

—or—

Click , and then click **New PublishView™ Document**.

- A blank letter-size document opens in the Documents Workspace. The orientation is portrait, which cannot be changed.
- The default margin settings for the top and bottom margins are one-inch. There are no settings for side margins.
- By default, a problem is added to the document.

- By default, the document contains the page number in a # of # format at the bottom of the sheet.
  - The scroll bars on the right side of the screen and at the bottom of the screen are active.
2. Add TI-Nspire™ applications and PublishView™ objects as needed to complete the document.

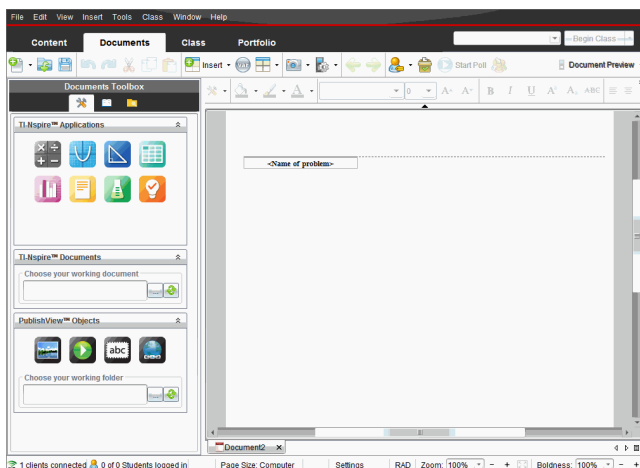

## About PublishView™ Documents

When working with PublishView™ documents, it is important to keep the following points in mind:

- PublishView™ documents are saved as .tnsp files, which distinguishes them from TI-Nspire™ documents (.tns files).
- When inserting PublishView™ objects into a document, the text, image, hyperlink, or embedded video are contained in boxes that can be moved and resized.
- When you insert TI-Nspire™ applications, they work the same way as pages in a TI-Nspire™ document.
- In a PublishView™ document, objects can overlap each other and you can control which object is on top or bottom.
- Objects can be placed and positioned in a PublishView™ document in a free-form fashion.
- You can convert an existing TI-Nspire™ document to a PublishView™ document (.tnsp file).

- When you convert a PublishView™ document to a TI-Nspire™ document (.tns file), TI-Nspire™ applications are converted. PublishView™ objects containing text, hyperlinks, videos, and images are not converted.
- You cannot create or open a PublishView™ document on a handheld. You must convert a PublishView™ document to a TI-Nspire™ document before sending it to a handheld.

## Exploring a PublishView™ Document

The following example shows how you might use TI-Nspire™ applications and PublishView™ objects to build a PublishView™ document. In this example, borders are turned on to show the boundaries around the objects. Showing borders enables you to work with objects easily while building a document. When you are ready to print or publish the document to the web, you can select to the hide borders.

If a Tree Falls... ①

---

Problem 1 ②

You have all heard the joke, "If a tree falls in a forest, will anyone hear it?" In this lesson, we explore the algebra to a falling tree and answer the question, "If a tree falls in your neighborhood, will it land on your car or house?"

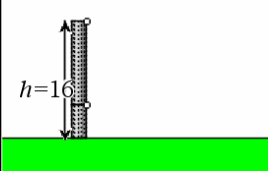
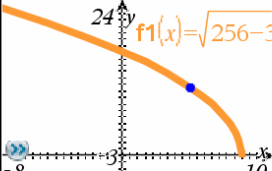
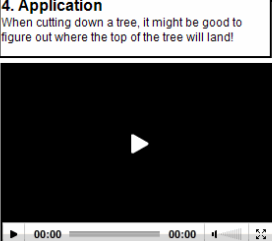
<p><b>1. Explore</b> Below, explore what happens if a 16 meter pole breaks by grabbing any of the two open circles. How far away from the base of the pole will the poll hit?</p> 	<p><b>3. Graph It</b> Graph your formula as a function. <i>Think: Do all values of the function apply to the situation above? Modify the function f to bound the range so that it makes sense.</i></p> 
<p><b>2. Solve It</b> Can you write a formula for the distance (d) in terms of height (h)?</p> <p><math>f1(x) := \sqrt{256 - 32 \cdot x}</math></p> <p><math>h^2 + d^2 = (16 - h)^2</math></p> <p><math>h^2 + d^2 = 256 - 32h + h^2</math></p>	<p><b>4. Application</b> When cutting down a tree, it might be good to figure out where the top of the tree will land!</p> 

⑤ ⑥

⑦

(c) Texas Instruments, Inc. 2010

1 of 1

- ① **Header.** In this example, the header contains the title of the document. When the header area is active, you can type and format text as needed.



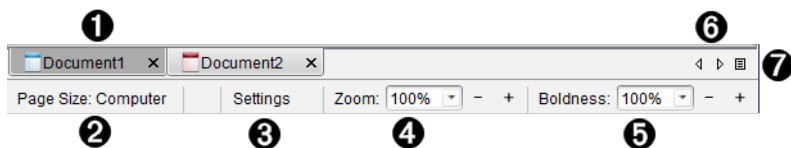

- 2 **Problem break and name.** In PublishView™ documents, use problem breaks to control the page layout. You can select to hide or show problem breaks. Deleting a problem removes the contents of the problem and removes the space between problems when there are multiple problems. Problem breaks also enable you to use variables in PublishView™ documents. Variables that have the same name are independent of one another if they are used in different problems.
- 3 **Text boxes.** In this example, the introduction text and the text in boxes 1, 2, 3, and 4 is contained in text boxes. You can insert text and hyperlinks into a PublishView™ document using a text box. Text boxes can be resized and positioned as needed. PublishView™ text boxes are not retained when you convert a PublishView™ document to a TI-Nspire™ document.
- 4 **TI-Nspire™ applications.** In this example, the author uses Graphs & Geometry to show the math functions. When a TI-Nspire™ application is active in a PublishView™ document, the appropriate application menu opens in the Documents Toolbox. You can work in a TI-Nspire™ application just as you would in a TI-Nspire™ document. When you convert a PublishView™ document to a TI-Nspire™ document, applications are retained.
- 5 **Notes application.** You can also use the TI-Nspire™ Notes application to add text to a PublishView™ document. Because Notes is a TI-Nspire™ application, it will be retained when you convert the PublishView™ document to a TI-Nspire™ document. Using the Notes application enables you to use an equation editor and can contain TI-Nspire™ math templates and symbols.
- 6 **Video.** This is an example of a video that is embedded in a PublishView™ document within a frame. Users can start and stop the video using the controls. Frames containing videos and images can be resized and positioned in the document as needed.
- 7 **Footer.** By default, the footer area contains the page number, which cannot be edited. You can add other text above the page number if needed. Like the header, you can format text as needed.

## Using the Status Bar in a PublishView™ Document

When a PublishView™ document is open, options on the status bar are different than when working in a TI-Nspire™ document.





- 1 Document names are displayed in tabs. If multiple documents are open, the document names are listed. You can have TI-Nspire™ and PublishView™ documents open at the same time. In this example, Document 1 is an inactive TI-Nspire™ document (). Document 2 is the active PublishView™ document (). Click the X to close a document.
- 2 **Page Size.** Shows the document's page size as Handheld or Computer. You can use the TI-Nspire™ **File** menu to convert a document from one page size to the other.
- 3 Click **Settings** to change Document Settings. You can specify settings that are specific to an active document or set default settings for all PublishView™ documents. When you convert a TI-Nspire™ document into a PublishView™ document, the settings in the TI-Nspire™ document convert to the settings defined for PublishView™ documents.
- 4 Use the **Zoom** scale to zoom the active document in or out from 10% to 500%. To set a zoom, type a specific number, use the + and - buttons to increase or decrease by increments of 10%, or use the drop-down box to choose preset percentages.
- 5 In TI-Nspire™ applications, use the **Boldness** scale to increase or decrease the boldness of text and line thickness within applications. To set the boldness, type a specific number, use the + and - buttons to increase or decrease by increments of 10%, or use the drop-down box to choose preset percentages.  
  
For PublishView™ objects, boldness is used to match text within TI-Nspire™ applications to other text on the PublishView™ sheet. It can also be used to increase the visibility of TI-Nspire™ applications when presenting a document to a class.
- 6 When there are too many open document names to show in the status bar, click the forward and backward arrows () to move through the documents.
- 7 Click  to see a list of all open documents.

## ***Saving PublishView™ Documents***

### **Saving a New Document**

1. Click **File > Save Document.**

—or—

Click .

The Save TI-Nspire™ Document dialog box opens.

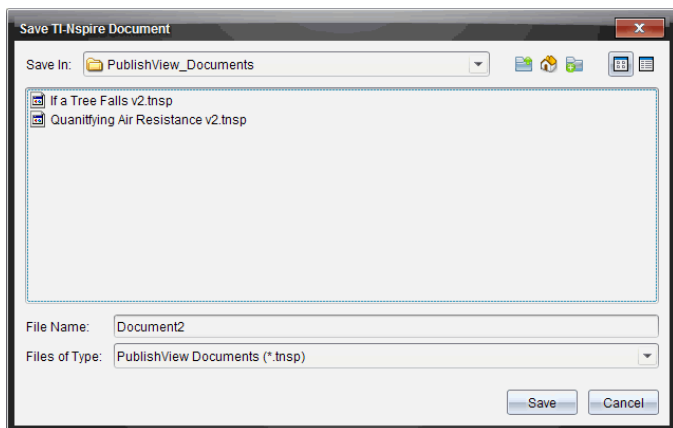

2. Navigate to the folder in which you want to save the document.

—or—

Create a folder in which to store the document.

3. Type a name for the new document.
4. Click **Save**.

The document closes and is saved with the extension .tnsp.

**Note:** When you save a file, the software first looks in the same folder the next time you open a file.

### **Saving a Document with a New Name**

To save a previously saved document in a new folder and/or with a new name:

1. Click **File > Save As** from the menu.

The Save TI-Nspire™ Document dialog box opens.

2. Navigate to the folder in which you want to save the document.

—or—

Create a folder in which to store the document.

3. Type a new name for the document.
4. Click **Save** to save the document with a new name.

**Note:** You can also use the **Save As** option to convert documents from TI-Nspire™ files to PublishView™ files or convert PublishView™ files to TI-Nspire™ files.

## ***Exploring the Documents Workspace***

When you create or open a PublishView™ document, it opens in the Documents Workspace. Use the menu options and the toolbar just as you would when working with a TI-Nspire™ document to:

- Navigate to existing folders and documents using Content Explorer
- Open existing documents
- Save documents
- Use the copy, paste, undo, and redo options
- Delete documents
- Access TI-Nspire™ application-specific menus
- Open the Variables menu in TI-Nspire™ applications that allow variables
- Access and insert math templates, symbols, catalog items, and library items into a PublishView™ document

**Note:** For more information, see *Using the Documents Workspace*.



## **Exploring the Documents Toolbox**

When a PublishView™ document is active, the Documents Toolbox contains tools needed for working with PublishView™ documents. You can add TI-Nspire™ applications to a problem, insert parts of existing TI-Nspire™ documents into a problem, and add PublishView™ objects.

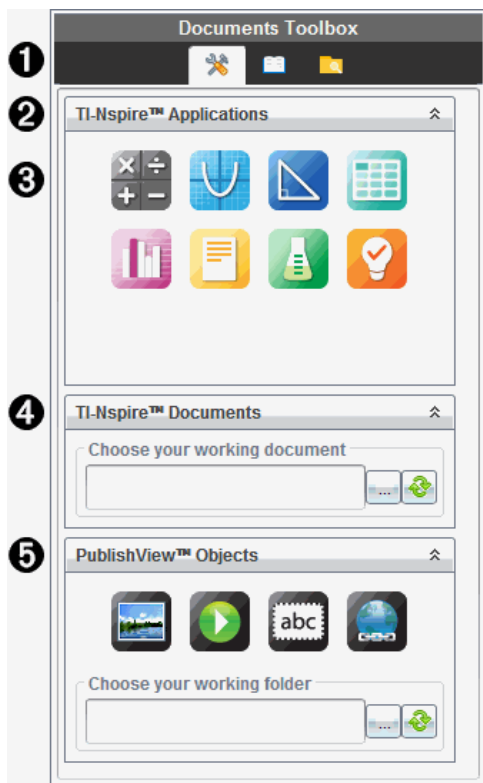

The Documents Toolbox opens when you create a new PublishView™ document or open an existing PublishView™ document. When working in a PublishView™ document, Page Sorter and TI-SmartView™ emulator are not available.



1 In a PublishView™ document:

- Click  to open the application menu and tools needed to work with TI-Nspire™ applications and PublishView™ objects.
- Click  to open the Utilities panel where you can access Math Templates, Symbols, the Catalog, Math Operators, and Libraries.
- Click  to open Content Explorer.

**Note:** For more information, see *Using the Documents Workspace*.

2 Click  to collapse a pane containing a menu. Click  to expand a pane.

3 TI-Nspire™ applications. Move an icon to a problem to insert an application:

 Calculator

 Graph

 Geometry

 Lists & Spreadsheet

 Data & Statistics

 Notes

 Vernier DataQuest™

 Question (Available in TI-Nspire™ CX Premium Teacher Software).

**4 TI-Nspire™ Documents.** Use this tool to locate and insert existing TI-Nspire™ documents (.tns files) into a problem.

**5 PublishView™ Objects.** Use this tool to move the following objects into a problem:

 Image

 Video

 Text box

 Hyperlink

## Using Menus and the Toolbar

When working in a PublishView™ document, select options from the menus or the toolbar in the Documents Workspace to work with content and objects. When you insert an object into a PublishView™ document, you can manipulate it using the same tools as you would when working with a TI-Nspire™ document. In PublishView™ documents, you can:

- Right-click on an object to open a context menu, which displays the actions that can be performed on that object.
- Use add, insert, and paste to add objects to a PublishView™ document.
- Use delete and cut to remove objects from a PublishView™ document.
- Move objects from one place to another within a PublishView™ document.

- Copy objects from one document and paste them into another PublishView™ document.
- Resize and scale objects such as text boxes and images.
- Change the font face and size and apply formatting such as italics, bold, underline, and color to text.

**Note:** For more information, see *Using the Documents Workspace*.

## **Using Context Menus**

In TI-Nspire™ applications and in PublishView™ documents, context menus provide a list of options specific to the task you are working on. For example, when you right-click a cell while working in the TI-Nspire™ Lists & Spreadsheet application, a context menu opens providing a list of actions that you can perform on that cell. When you right-click the border of a text box in a PublishView™ document, the context menu provides actions that can be performed on the text box.

### **Context Menus in TI-Nspire™ Applications**

When you insert a TI-Nspire™ application into a PublishView™ document, the application menu and the context menus associated with that application are available and work the same way they work in a TI-Nspire™ document.

### **Context Menus in PublishView™ Documents**

In PublishView™ documents, context menus provide shortcuts to frequently performed tasks. Context menus are specific to an object or area:

- The Sheet context menu provides options for working with the layout of the sheet and document.
- Object context menus provide options for manipulating the object.
- Content-sensitive context menus provide options for working with the content inside the object such as text or a video.

## **Working with PublishView™ Objects**

In a PublishView™ document, text, hyperlinks, images, and videos are contained in PublishView™ objects. You can move, resize, copy and paste, and delete an object within a PublishView™ document. Objects can also be positioned so that one overlaps the other.

Within a document, PublishView™ objects can exist in three states: unselected, selected, and interactive.

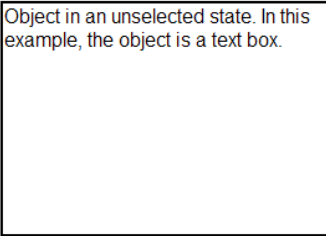
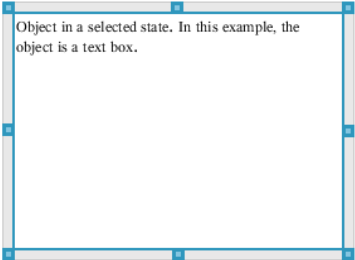
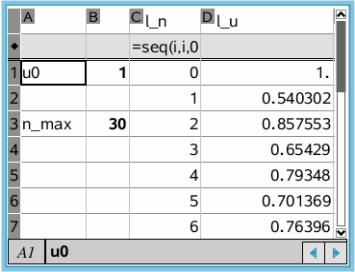
State	Description																																					
Unselected	<p>When unselected, an object does not have handles for repositioning and sizing. To deselect an object, left-click or right-click outside the object. In this example, borders around the object are showing.</p>	 <p>Object in an unselected state. In this example, the object is a text box.</p>																																				
Selected	<p>When selected, an object will have eight square handles framing the object. To select an object, click the object's border. When selected, objects can be moved and resized.</p> <ul style="list-style-type: none"> <li>• To move an object, click a border and drag the object to its new location.</li> <li>• To resize an object, grab a handle.</li> <li>• Right-click the border to open a context menu with options for manipulating the object.</li> </ul>	 <p>Object in a selected state. In this example, the object is a text box.</p>																																				
Interactive	<p>An interactive state is indicated by a blue frame around the object. To enter interactive state, left-click or right-click anywhere in the body of the object. When in an interactive state, you can work with the contents of the object. For example, you can add or edit text in a text box or complete math functions in a TI-Nspire™ application. When in an interactive state, context menus contain options specific to the contents of an object.</p>	 <table border="1"> <thead> <tr> <th>A</th> <th>B</th> <th>C</th> <th>D</th> </tr> </thead> <tbody> <tr> <td></td> <td></td> <td><math>=seq(i,i,0)</math></td> <td></td> </tr> <tr> <td>1</td> <td>u0</td> <td>1</td> <td>0</td> </tr> <tr> <td>2</td> <td></td> <td></td> <td>1</td> </tr> <tr> <td>3</td> <td>n_max</td> <td>30</td> <td>2</td> </tr> <tr> <td>4</td> <td></td> <td></td> <td>3</td> </tr> <tr> <td>5</td> <td></td> <td></td> <td>4</td> </tr> <tr> <td>6</td> <td></td> <td></td> <td>5</td> </tr> <tr> <td>7</td> <td></td> <td></td> <td>6</td> </tr> </tbody> </table>	A	B	C	D			$=seq(i,i,0)$		1	u0	1	0	2			1	3	n_max	30	2	4			3	5			4	6			5	7			6
A	B	C	D																																			
		$=seq(i,i,0)$																																				
1	u0	1	0																																			
2			1																																			
3	n_max	30	2																																			
4			3																																			
5			4																																			
6			5																																			
7			6																																			

## Inserting an Object

1. In the Documents Toolbox, ensure the PublishView™ Objects menu is open.

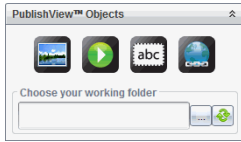

2. Use your mouse to click an icon and drag it to the document.
3. Release the mouse button to drop the object into the document.

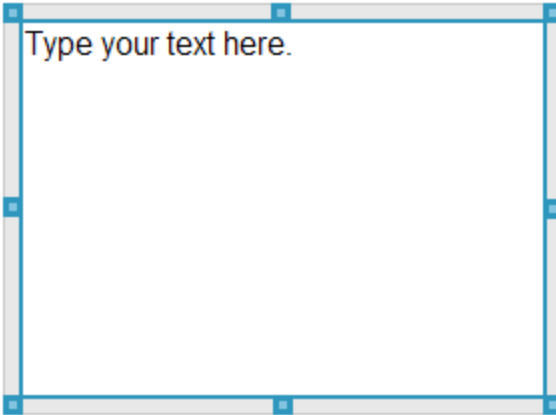

Selected text boxes and frames can be resized, moved, copied, pasted, and deleted.





- Using the mouse, grab the handles to resize the object and drag it to position the object in the document as needed.

### Opening Object Context Menus

- Right-click the border of any object in a PublishView™ document.

The context menu opens to provide access to delete, copy/paste, cut, and bring to front/send to back actions.

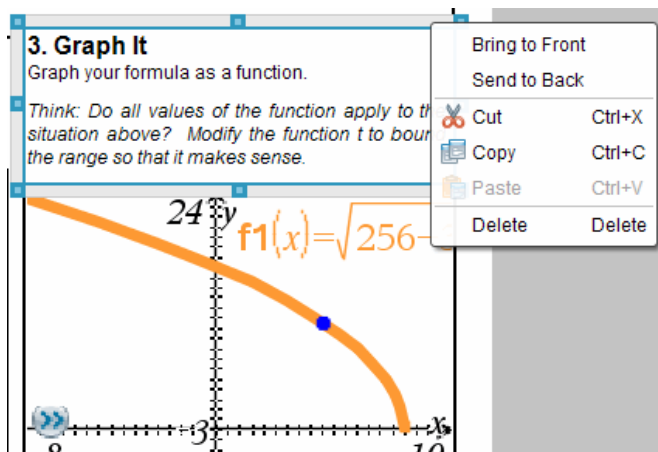

### Resizing an Object

- Click any border around the object to select it. The border becomes a bold blue line and the handles are active.
- Move your mouse over one of the handles to activate the resizing tool.



- Grab one of the handles and drag in the direction needed to make the object larger or smaller.
- Click outside the object to save the new size.

### Moving an Object

To move an object to another location on the page:

- Click any border around the object to select it. The border becomes a bold blue line and the handles are active.

2. Move your cursor over one of the borders to activate the positioning tool .
3. Click to grab the object. The horizontal and vertical alignment guides are activated at the top and bottom of the object. Use the grid lines to position the object on the page.

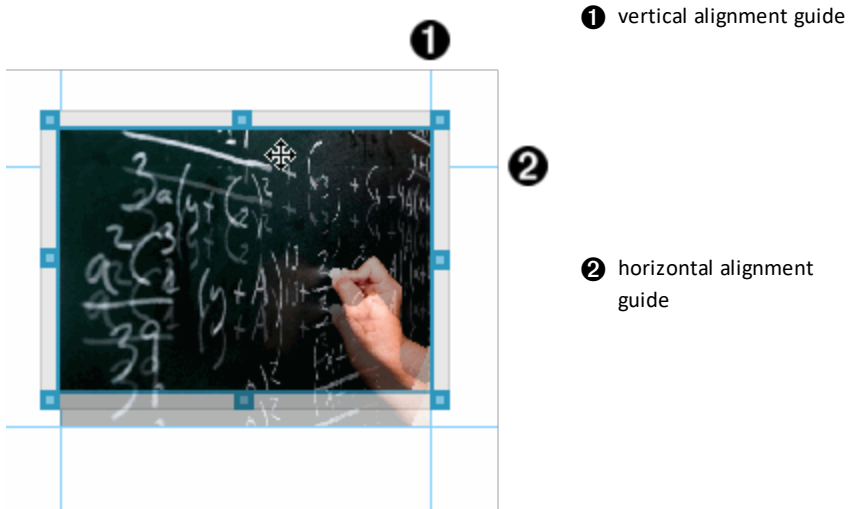

4. Drag the object to a new location on the page.
5. Release the mouse button to drop the object in its new location.

### Overlapping Objects

You can position objects so that one is on top of another. You can control the stacking order to specify which object is positioned in front or behind the other. Overlapping objects have many practical uses when presenting information in the classroom. For example, you can create a "curtain control" by placing an empty text box over other objects. Then, you can move the text box to reveal the items below it one at a time.

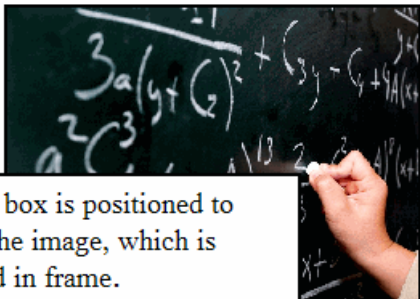

This text box is positioned to overlap the image, which is contained in frame.

To change the position of an object in the stacking order:

1. Click the border of the object you want to position to select it, and then right-click to open the context menu.

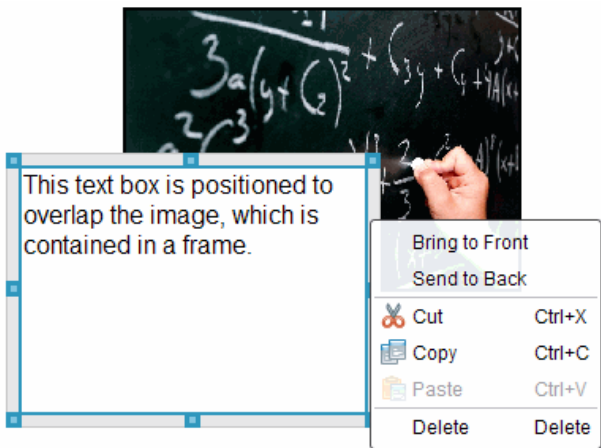

2. Click **Send to back** or **Bring to front** to move the selected object to the desired position.

### Deleting an Object

To delete an object from a sheet:

1. Click any border of the object to select it. When an object is selected, the border is blue and the handles are active.
2. Press the **Delete** key to delete the text box.

—or—

Right-click a border, and then click **Delete** from the context menu.

### Choosing a Working Folder for PublishView™ Objects

Use the Choose Your Working Folder field in the PublishView™ Objects pane to select a folder for storing PublishView™ documents and related files.

1. Ensure the PublishView™ Objects pane is open.

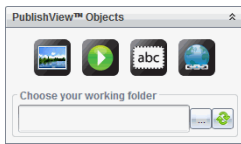

2. Click .

The Choose Your Working Folder dialog box opens.

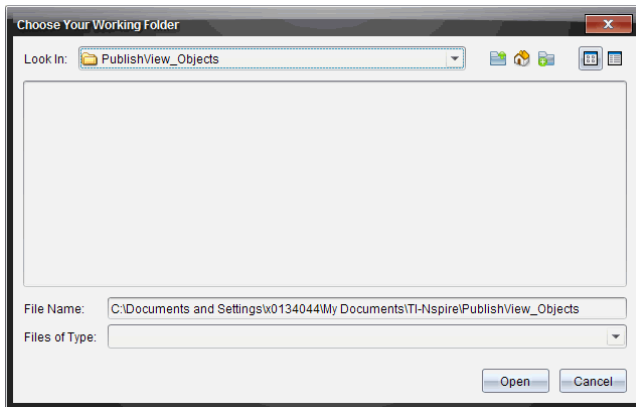

3. Navigate to the folder where you want to store video and image files.
4. Click **Open** to choose the working folder.

The selected folder becomes the working folder and the folder name is displayed in the **Choose your working folder** field. Previews of supported images and video files in the folder are shown in the PublishView™ objects pane.

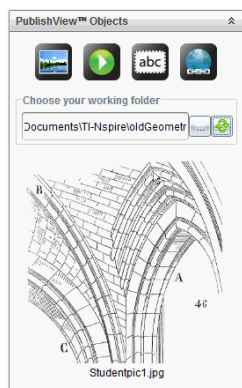

5. To add an image or video file to a PublishView™ document, select the file and move it onto the active sheet.

### ***Working with TI-Nspire™ Applications***

**Note:** For more information, see the appropriate chapter in this guidebook.

#### **Adding an Application to a Problem**

To add a TI-Nspire™ application to a problem in a PublishView™ document:

1. Choose one of the following actions to select an application:
  - From the TI-Nspire™ Applications pane in the Documents Toolbox, use the mouse pointer to point to the application and drag it to the problem.
  - From the menu bar, click **Insert** and choose an application from the drop-down menu.
  - Right-click inside the sheet to open the context menu, click **Insert** and choose an application from the menu.

The application is added to the sheet.

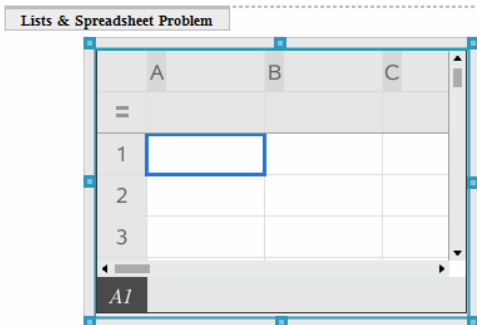

2. Using your mouse, grab the handles to resize or position the application object as needed.
3. Click outside the application frame to accept the dimensions.
4. To open the menu for the active TI-Nspire™ application, click inside the application.

The menu opens in the Documents Toolbox above the TI-Nspire™ Applications pane.

Right-click on an application element, such as a cell or function to open the context menu for that item.

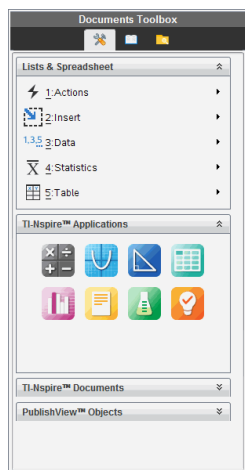

5. To work in the application, click an option from the application menu. Click  to collapse the application menu pane.

## Adding Existing TI-Nspire™ Documents

Use the TI-Nspire™ Documents pane to open an existing TI-Nspire™ document to add to a PublishView™ document. When you open an existing TI-Nspire™ document, all pages of the document appear in the preview pane. You can move complete problems or individual pages onto the PublishView™ sheet.

### Choosing a Working TI-Nspire™ Document

To choose a working document:

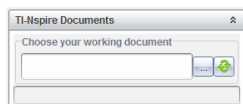

1. In the Documents Toolbox, ensure the TI-Nspire™ Documents pane is open.



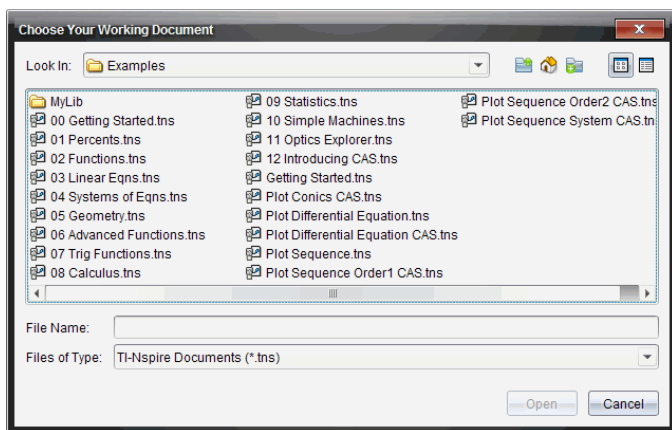

2. Click .

The **Choose Your Working Document** dialog box opens.



3. Navigate to the folder in which the TI-Nspire™ document is stored:
  - Click ▼ in the **Look in:** field to use a file browser to locate a folder.
  - From an open folder, click  to move up a level in the folder hierarchy.
  - Click  to return to the default home folder.
  - Click  to add a new folder to open folder on your computer.

- Click  to list folders and files. To show details, click .

4. Select the file, and then click **Open**.

The TI-Nspire™ document opens in the TI-Nspire™ Documents pane.

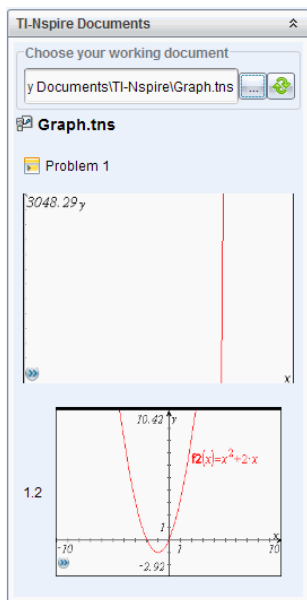

5. To add the TI-Nspire™ document to the PublishView™ document, move one page at a time or one problem at a time to the PublishView™ sheet.

If you are adding a problem with multiple pages, the pages are stacked on top of each other on the PublishView™ sheet. Move the top page to see the other pages.

### **Working with Problems**

Like a TI-Nspire™ document, a PublishView™ document consists of one or more problems.

Problems are used to control the layout of a PublishView™ document so that you can isolate variables. When variables with the same name are used in multiple problems, variables can have different values. To add problems to PublishView™ documents, open the Sheet context menu or use the options on the Insert menu in the Documents Workspace. When adding problems, keep the following guidelines in mind:

- By default, a new PublishView™ document contains one problem.
- You can insert a problem after any existing problem.
- You cannot insert a problem in the middle of an existing problem.



- A new problem break is always inserted after the selected problem.
- Inserting a problem break adds empty space below the break.
- Any object between two problem breaks is part of the problem above the break.
- The last problem includes all sheets and objects below the last problem break.
- Problem breaks are not relative to any object, which lets you move objects within a problem without affecting the problem break location.

## Adding a Problem

To add a problem to an open PublishView™ document:

1. Right-click anywhere on the sheet, and then click **Insert > Problem**.

The problem is added to the document below any existing problems. The problem break provides a visible divider between problems.



2. To name the problem, highlight the default text, type a name, and then click outside the text box to save the name.

The problem break is saved.



If a document has multiple problems, use the scroll bar on the right side of the document to move up and down through the problems.

## Managing Problem Breaks

Problem breaks are used to separate problems and variable sets.

- Every problem has a problem break.
- A problem break becomes visible when a problem is added to a document.
- A problem break is represented by a dashed line with the name of the problem positioned on the left side of the sheet.
- By default, the problem name is shown as **<Name of problem>**. Highlight the default text to type a new name for the problem.
- Problem names do not have to be unique. Two problems can have the same name.

## Hiding and Showing Problem Breaks

You can select to hide or show problem breaks in a PublishView™ document. By default, problem breaks are shown.

1. Right-click in any blank area of the document (outside of any object) to open the sheet context menu.
2. Click **Layout Options**.

The Show/Hide Options dialog box opens.

**Note:** You can also click **View > PublishView™ Layout Options**.

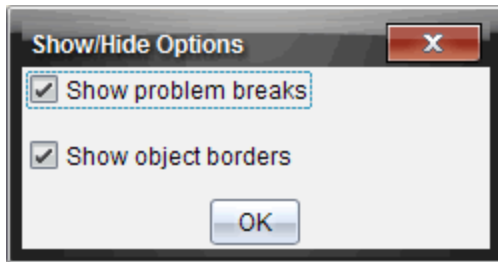

3. Clear the **Show problem breaks** option to hide problem breaks in the document. Select the option to return to the default setting and show the problem breaks.
4. Click **OK** to close the dialog box.

## Renaming a Problem

1. Click the existing problem name on the problem break line.
2. Type a new name for the problem.
3. Click outside the text box to save the new name.

## Deleting a Problem

To delete a problem, complete one of the following actions:

- ▶ Select the problem break and click  on the right side of the break.
- ▶ Click **Edit > Delete**.
- ▶ Right-click the problem break and click **Delete**.
- ▶ Select the problem break and press the **Delete** or **Backspace** key.

When you delete a problem, all objects contained in the problem are removed and the space between the selected problem break and the next problem break is removed.

## **Organizing PublishView™ Sheets**

A PublishView™ document can have multiple sheets. A single sheet is displayed in the workspace on your screen. All work occurs in the PublishView™ objects and TI-Nspire™ applications within sheets.

### **Adding Sheets to a Document**

To add a sheet to a document:

- ▶ Click **Insert > Sheet**.

The sheet is added to the document and the numbering increments by one.

### **Opening the Sheet Context Menu**

- ▶ Right-click in any blank area (outside of any object) in a PublishView™ sheet.

A context menu opens with options for inserting problems, pages, applications, and PublishView™ objects, edit options for removing space or deleting a page, and options for hiding and showing problem breaks and object borders.

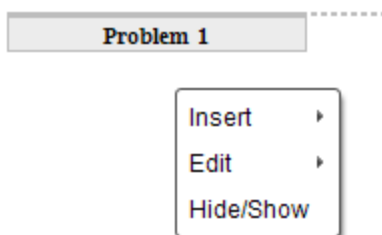

### **Page Numbering**

In a PublishView™ document, page numbering is displayed in the bottom margin (footer). By default, numbering is placed in the center of the PublishView™ sheet in a # of # format. You cannot edit or delete page numbering.

### **Working with Headers and Footers**

PublishView™ documents contain space at the top and bottom of a sheet to add a header or a footer. Headers and footers can contain the date, the document name, the lesson plan name, the class name, your school's name, or any other information needed to identify a document.

By default, headers and footers do not contain content and boundaries for the header and footer are hidden. To activate a header or footer for editing, click inside the top or bottom margin. When activated, a text box with a light gray border is displayed.

### **Inserting and Editing Text in Headers and Footers**

1. Click inside the top or bottom margin.

The text box borders in the margin become visible and the object space is disabled. The cursor is placed in the header or footer space and the formatting toolbar becomes active.

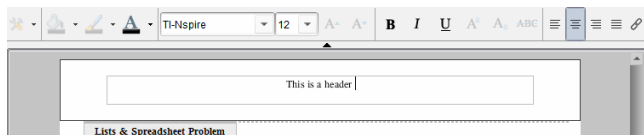

2. Type the text.

- The default font is TI-Nspire™ true type, 12 pt, normal.
- By default, text is centered horizontally and vertically.
- Text can be aligned: left, center, right, or justified.
- Text that does not fit within the text box horizontally will wrap to the next line.
- Text that does not fit within the text box vertically will not be shown, but text is retained. (If you delete text, the hidden text will appear.)

3. Complete one of the following actions to save the text:

- Single-click anywhere outside the header or footer text box to save the text.
- Press **Esc** to save the text.

The PublishView™ sheet becomes active and the formatting menu closes.

### **Showing and Hiding Borders**

By default, borders are displayed when you insert an object into a problem. When you select to hide borders, the selection applies to all objects in the document and to objects that you add to the document. To hide the border:

1. Right-click in any blank area of the sheet (outside of any object) to open the context menu.
2. Click **Layout Options**.

The Layout Options dialog box opens.

**Note:** You can also click **View > PublishView™ Layout Options**.

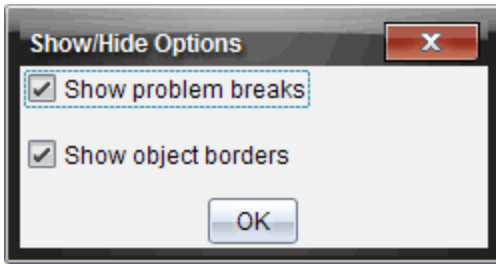

3. Clear the **Show object borders** option to hide the borders around the objects in the problem. Select the option to return to the default setting and show borders.
4. Click **OK** to close the dialog box.

### **Adding and Removing Space**

To manage how PublishView™ objects appear on a sheet, you may need to add or delete space between objects.

**Note:** You can add and remove vertical space between objects using this method. To add or remove horizontal space between objects, move the object.

#### ***Adding Space***

1. Right-click in the area outside of any object where you want to add space. The context menu opens.
2. Click **Edit > Add/Remove Space**. The Add/Remove Space tool becomes active.



Drag up and press enter to remove space

Add/Remove Space  
tool

Drag down and press enter to add space



3. Use your mouse to position the tool to the exact place where you want to add space.
4. Click the tool, and then drag **down** to select the amount of space you want to add. As you select the amount of space to be added, it is indicated in green.

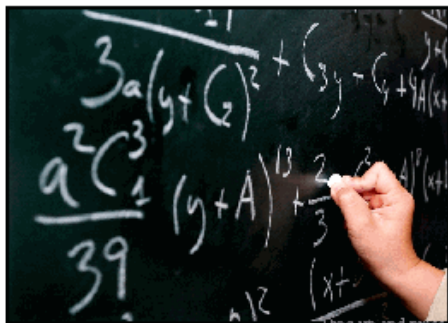

Drag up and press enter to remove space

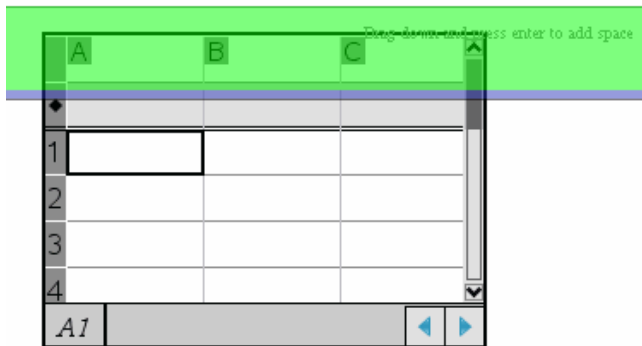

Drag down and press enter to add space

5. Press the **Enter** key to add the space in between the objects. You can adjust the amount of space by dragging up and down before you press **Enter**.

### **Removing Space**

1. Right-click in the area outside of any object where you want to remove space.

The context menu opens.

2. Click **Edit > Add/Remove Space**.

The Add/Remove Space tool becomes active.



Drag up and press enter to remove space

Drag down and press enter to add space



Add/Remove Space  
tool

3. Use your mouse to position the tool to the exact place where you want to remove space.
4. Click the tool, and then drag **up** to select the amount of space you want to remove. As you select the amount of space to be removed, it is indicated in red.

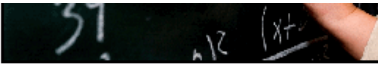

Drag up and press enter to

Drag down and press enter

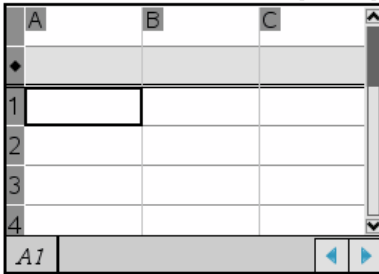

5. Press the **Enter** key to remove the space in between the objects. You can adjust the amount of space by dragging up and down before you press **Enter**.



**Note:** If there is not enough space on the sheet to accommodate the objects, the objects won't be moved when space is removed.

## Deleting Blank Sheets from Problems

You can delete a sheet that does not contain any TI-Nspire™ applications or PublishView™ objects from a problem. To delete a blank sheet from a problem:

1. Delete any TI-Nspire™ applications, PublishView™ objects, move or delete any problem breaks from the sheet.
2. Place your cursor inside the sheet you want to delete.
3. Right-click inside the blank sheet to open the context menu.
4. Click **Edit > Delete Sheet**.

The blank sheet is removed from the problem.

## Using Zoom

The zoom feature lets you zoom in on any object or area on the PublishView™ document for discussion, and zoom out to see an overview of the lesson. The zoom uses the center point of the viewable area to zoom in.

The default zoom setting is 100%.

- ▶ To change the zoom percentage, do one of the following:
  - Type the number in the box and press **Enter**.
  - Use the - and + buttons to decrease or increase the percentage in 10% increments.
  - Use the drop-down arrow to choose a preset percentage.

The zoom settings are retained when you save the document.

## Adding Text to a PublishView™ Document

In a PublishView™ document, there are three ways to add text:

- Insert a PublishView™ text box to enter free-form text or copy text from other sources into the document. For example, you can place a PublishView™ text box next to an image and type a description in a text box. You can also copy and paste text from .doc, .txt, and .rtf files. Use PublishView™ text boxes when you need options for emphasizing and formatting text. PublishView™ text boxes are not converted when you convert a PublishView™ document to a TI-Nspire™ document. You may want to use a PublishView™ text box to add text that you don't want handheld users to see.
- Use the TI-Nspire™ Notes application. You should use the Notes application when you need an advanced equation editor and when you need to use TI-Nspire™ math templates and symbols. Superscript and subscript are also easier to use in the

Notes application. You should also use Notes when you are planning to convert the PublishView™ document to a TI-Nspire™ document for use on a handheld and you want handheld users to see the text.

- Add text in TI-Nspire™ applications that allow text just as you would in a TI-Nspire™ document.

### Inserting Text into a Text Box

1. Ensure the PublishView™ Objects pane is open.

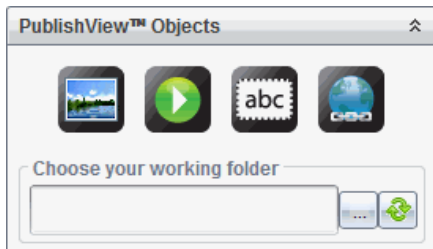

2. Use your mouse to click  and drag it to the problem.
3. Release the mouse button to drop the text box into the problem.

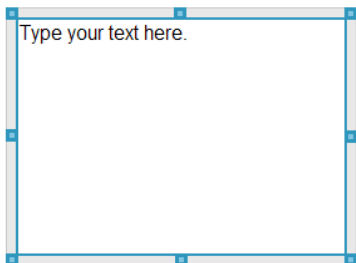

4. Using the mouse, grab the handles to resize the text box or position in the problem as needed.
5. Click outside the text box to save the size and position.
6. Click "Type your text here."

The formatting toolbar becomes active. The text box is in an interactive state for adding or editing text.

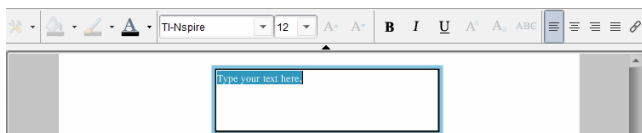

7. Type the new text.  
—or—  
Copy and paste text from another file.
8. Apply formatting as needed.
9. Click outside the text box to save the text.

### Formatting and Editing Text

The options for editing and formatting text are located on a formatting toolbar at the top of the active document. Formatting options for editing text include:

- Changing the font, font size, and font color.
- Applying bold, italics, and underline formatting.
- Applying the following text horizontal alignment options: left, right, centered, and justified.
- Inserting hyperlinks.

### Launching Edit Mode

- ▶ Click inside a text box to launch edit mode.
  - The formatting menu opens.
  - The text is selectable for editing.

### Opening the Content Context Menu

- ▶ Right-click inside a text box containing text or a hyperlink.

The formatting menu and context menu open providing shortcuts to cut, copy, and paste.

### Using Hyperlinks in PublishView™ Documents

In PublishView™ documents, use hyperlinks to:

- Link to a file
- Link to a website on the Internet

You can add a hyperlink to an open document or you can convert any text within a text box to a hyperlink. When a hyperlink is added, the formatting of the text is underlined and the font color is blue. You can change the formatting of the hyperlinked text without losing the hyperlink.

If a link is broken, an error message is displayed when you click the link:

- Cannot open the specified file
- Cannot open the specified web page

PublishView™ text boxes support both absolute and relative links.

Absolute links contain the complete location of the linked file and do not depend on the location of the main document.

Relative links contain the location of the linked file relative to the main document. If you have multiple lessons in a single folder and they are all linked using relative addressing, you can move the folder to any other location (another local folder, datashare, flash drive, online) without breaking the links. The links also stay intact if you bundle the documents into a lesson bundle or zip them into a zip file and share them.

**Note:** The PublishView™ document must be saved before you can insert a relative hyperlink.

### Linking to a File

You can link to any file on your computer. If the file type is associated with an application on your computer, it will launch when you click the link. There are two ways to link to a file; by typing or pasting a file address into the Address field, or by browsing to a file.

#### *Linking to a File by Using an Address*

1. Ensure the PublishView™ Objects pane is open.

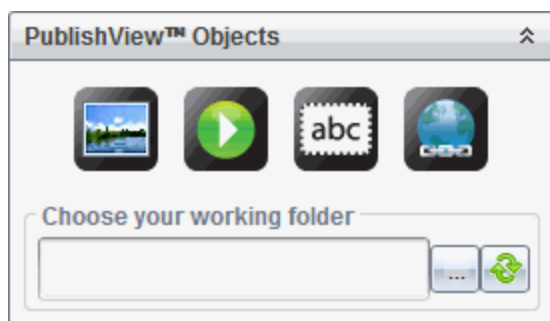

2. Drag the hyperlink icon  onto the document.

The Hyperlink dialog box opens.

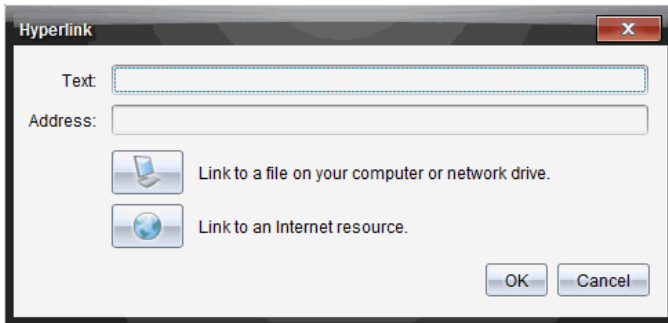

3. Type the name of the link in the Text field. For example, this can be the name of the document.
4. Copy the location of the file path you want to link to, and paste it in the Address field.

—or—

Type the location of the file in the Address field.

**Note:** Type ../ to designate parent directories. For example:

../../lessons/mathlesson2.tns

5. Click **OK** to insert the link.

A text box containing the hyperlink is added to the PublishView™ document.

### ***Linking to a File by Browsing***

1. Ensure the PublishView™ Objects pane is open.

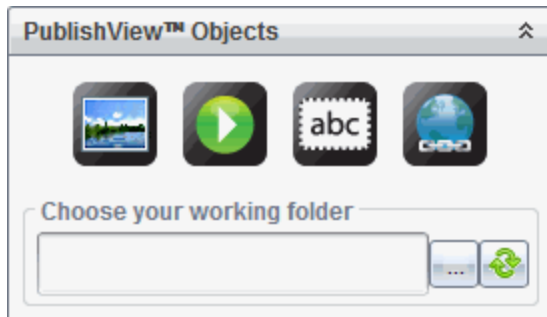



2. Drag the hyperlink icon onto the document.

The Hyperlink dialog box opens.

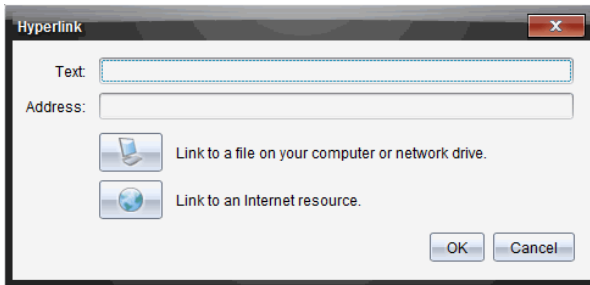

3. Type the name of the link in the Text field. For example, this can be the name of the document.

4. Click  to select **Link to a file on your computer or network drive**.

The **Select file to insert as hyperlink** dialog box opens.

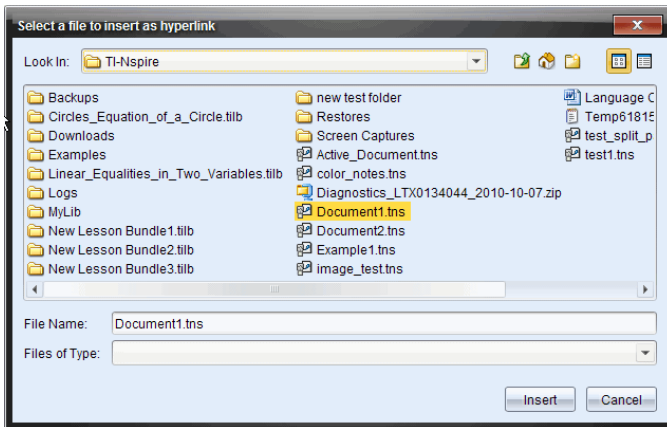

5. Navigate to and select the file you want to link to, and then click **Insert**.

The path name is inserted into the Address field in the Hyperlink dialog box.

If the software is unable to determine if the link is a relative or absolute address, the Hyperlink dialog box opens with an option to change the type of link.

To change the link, click the appropriate option:

- **Change to absolute address.**
- **Change to relative address.**

6. Click **OK** to insert the link.

—or—

Click **Start Over** to go back to the Hyperlink dialog box and choose a different file to link, or to edit the Text or Address fields.

A text box containing the hyperlink is added to the PublishView™ document.



7. Using the mouse, grab the handles to resize the text box.

—or—

Grab any border to position the text box in the document as needed.

### **Linking to a Website**

There are two ways to link to a website; by typing or pasting the URL into the Address field, or by browsing to a file.

#### ***Linking to a Website by Using an Address***

1. Ensure the PublishView™ Objects menu is open.



2. Drag the hyperlink icon onto the document to open the Hyperlink dialog box.
3. Type or paste the URL you want to link to in the Address field.
4. Click **OK**.

A text box containing the hyperlink is added to the PublishView™ document.

### ***Linking to a Website by Browsing***

1. Ensure the PublishView™ Objects menu is open.



2. Drag the hyperlink icon onto the document to open the Hyperlink dialog box.
3. Click  to select **Link to an Internet resource**.

The browser opens to your default website.

4. Navigate to the website or file on a website that you want to link to.
5. Copy the URL, and then paste it in the Address field in the Hyperlink dialog box.

—or—

Type the URL in the Address field.

6. Click **OK**.

A text box containing the hyperlink is added to the PublishView™ document.



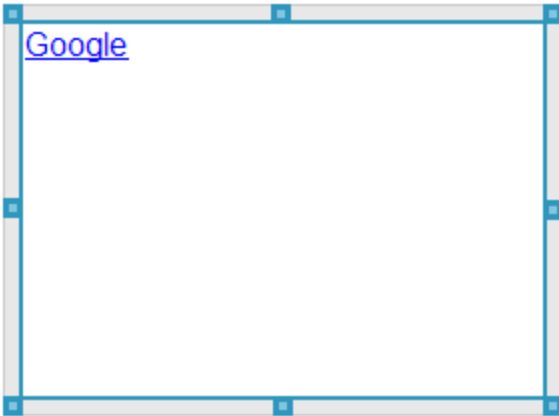

7. Using the mouse, grab the handles to resize the text box.

—or—

Grab any border to position the text box in the document as needed.

### Editing a Hyperlink

To change the name of a hyperlink, change the path, or change the URL, complete the following steps.

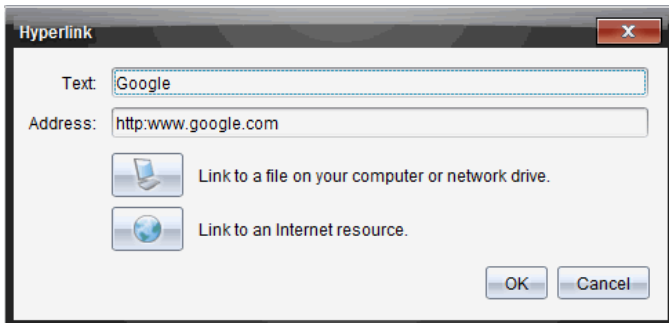

1. Using your mouse, right-click the hyperlink text, and then click **Edit hyperlink**.

The Hyperlink dialog box opens.



2. Make corrections as needed:

- Type corrections to the hyperlink name in the **Text** field.

- Click  to open the **Select a file to add as a hyperlink** dialog box and use the file browser to navigate to the folder where the file is located.
  - Click  to open a browser and navigate to a website to copy and paste the correct the URL in the **Address** field.
3. Click **OK** to save the changes.

### Converting Existing Text to a Hyperlink

1. Click inside the text box to activate edit mode and open the formatting menu.
2. Select the text you want to convert to a hyperlink.
3. Click .

The Hyperlink dialog box opens with the selected text in the Text field.

4. Click  to create a link to a file.

—or—

Click  to create a link to page on a website.

### Removing a Hyperlink

Use this process to remove a link from text inside a text box. The text remains in the document.

1. Using your mouse, right-click the hyperlink text.
2. Click **Remove hyperlink**.

The hyperlink formatting is removed from the text and the text is no longer clickable.

**Note:** To remove both the text and hyperlink, delete the text. If a text box contains only the linked text, delete the text box.

### Working with Images

Images can be added to PublishView™ documents as PublishView™ objects or can be added inside TI-Nspire™ applications that support images. Supported files types are .bmp, .jpg, and .png files.

**Note:** If a TI-Nspire™ application is active in the PublishView™ document, the image is added to the TI-Nspire™ page if you click **Insert > Image** from the menu bar or context menu. If there is no TI-Nspire™ document active, the image is added as a

PublishView™ object. Only images inside TI-Nspire™ applications convert to TI-Nspire™ documents (.tns files).

## Inserting an Image

1. Ensure the PublishView™ Objects pane is open.

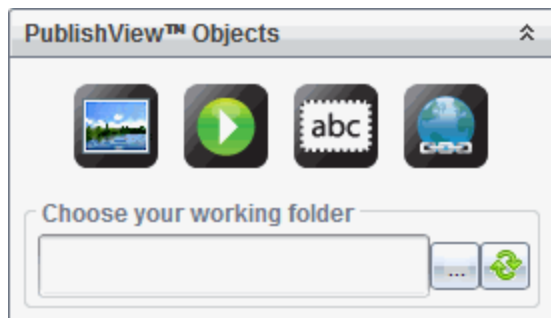

2. Click , and then drag the icon to the document.

The **Choose an image to insert into PublishView™** dialog box opens.

**Note:** By default, the Texas Instruments preloaded images folder is displayed.

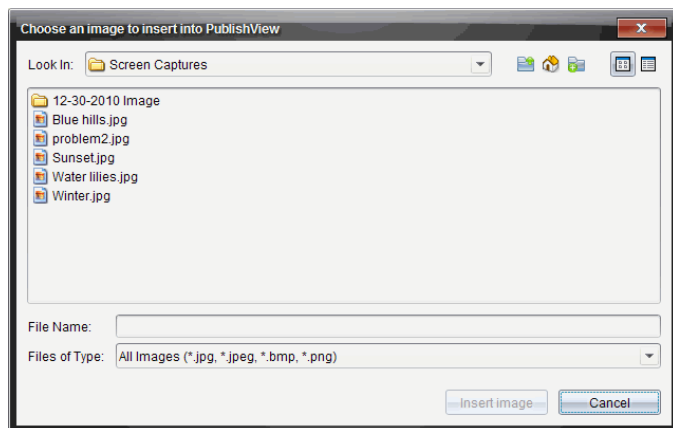

3. Navigate to the folder where the image file you want to insert is located, and then highlight the file name.
4. Click **Insert image**.

The image is added to the PublishView™ sheet.

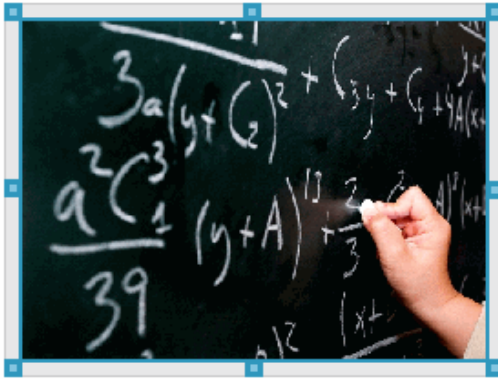

- Using the mouse, grab the handles to resize the text box,

—or—

Grab any border to position the text box in the document as needed.

### Moving Images

- Click the frame containing the image to select it.
- Move your cursor over the edge of the image to activate the positioning tool. 
- Move the image to its new location on the PublishView™ sheet.

**Note:** Objects can overlap each other on a PublishView™ sheet.

### Resizing Images

- Click the frame containing the image to select it.
- Move your cursor over one of the blue handles to activate the resizing tool. 
- Drag the handle to make the image smaller or bigger.

### Deleting Images

- Click the image to select it, and then press the **Delete** key.  
—or—
- Right-click a handle to open the context menu, and then click **Delete**.

## Working with Video Files

You can embed video files in a PublishView™ document and play the videos directly from the PublishView™ document. You can also insert a link to a video that will launch in a new browser window or media player window. For more information, see *Working with Hyperlinks*.

**Note:** PublishView™ supports the MP4 (MPEG-4 multimedia container) format with H264/AVC (Advanced Video Coding) video compression and AAC audio.

### Inserting a Video

1. Ensure the PublishView™ Objects pane is open.
2. Click , and then drag the icon to the document.

The **Choose a video to insert into PublishView™** dialog box opens.

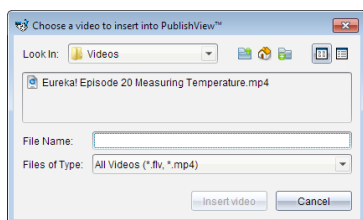

3. Navigate to the folder where the video file you want to insert is located, and select the file name.
4. Click **Insert video**.

An object containing the embedded video is added to the PublishView™ sheet. By default, the resizing and positioning handles are active.



- Using the mouse, grab the handles to resize the object or grab any border to position the object in the document as needed. For example, you may want to position the object containing the video above or below a text box that contains text introducing the video.
- To play the video, click the forward arrow, or click anywhere in the viewing window.

### Using the Video Console

The video console lets users control the video.



- Starts or stops the video.
- Shows the elapsed time as the video plays.
- Mutes or unmutes the audio.

## Converting Documents

You can convert PublishView™ documents (.tnsp files) to TI-Nspire™ documents (.tns files) for display on handhelds. You can also convert TI-Nspire™ documents to PublishView™ documents.

Converting a document creates a new document—the original document remains intact and is not linked to the new document. If you make changes to one document, the changes are not reflected in the other document.

### Converting PublishView™ Documents to TI-Nspire™ Documents

You cannot open a PublishView™ document (.tnsp file) on a handheld. However, you can convert the PublishView™ document to a TI-Nspire™ document that can be transferred to and opened on a handheld. When you convert a PublishView™ document to a TI-Nspire™ document:

- Only the TI-Nspire™ applications become part of the TI-Nspire™ document.
- PublishView™ objects such as text boxes, images, hyperlinks, and videos are not converted.
- Text contained in PublishView™ text boxes is not converted; however, text in a TI-Nspire™ Notes application is converted.

- If images are contained in a TI-Nspire™ application, they are converted; however, images contained in PublishView™ objects are not converted.

Complete the following steps to convert a PublishView™ document (.tnsp file) to a TI-Nspire™ document (.tns file).

1. Open the PublishView™ document to be converted.
2. Click **File > Convert to > TI-Nspire™ Document**.
  - The new TI-Nspire™ document opens in the Documents Workspace.
  - All supported TI-Nspire™ applications are part of the new TI-Nspire™ document.
  - Starting from top to bottom, and then left to right, the layout of the TI-Nspire™ document is based on the order of the TI-Nspire™ applications in the PublishView™ document.
    - Every TI-Nspire™ application in a PublishView™ document will appear as a page in the converted TI-Nspire™ document. The order of the pages in the TI-Nspire™ document is based on the layout of the TI-Nspire™ applications in the PublishView™ document.
    - If two or more problems are at the same level, the order is left to right.
  - Problem breaks are maintained.
  - The new TI-Nspire™ document is not linked to the PublishView™ document.
3. When work in the document is complete, click  to save the document in the current folder.

—or—

Click **File > Save As** to save the document in a different folder.

**Note:** If the document has never been saved, both the **Save** and **Save as** options allow saving in a different folder.

**Note:** You can also use the **Save as** option to convert a PublishView™ document to a TI-Nspire™ document.

**Note:** If you try to convert a PublishView™ document that does not contain TI-Nspire™ pages or applications, an error message is displayed.

## Converting TI-Nspire™ Documents to PublishView™ Documents

You can convert existing TI-Nspire™ documents to PublishView™ documents, which enables you to take advantage of the richer layout and editing features for printing, generating student reports, creating worksheets and assessments, and publishing documents to a website or blog.

Complete the following steps to convert a TI-Nspire™ document to a PublishView™ document:

1. Open the TI-Nspire™ document you want to convert.
2. Click **File > Convert to > PublishView™ Document**.
  - The new PublishView™ document opens in the Documents Workspace.
  - By default, there are six objects per page.
  - When converted, each problem from the TI-Nspire™ document will start a new sheet in the PublishView™ document.
  - Problem breaks are maintained.
3. When work in the document is complete, click  to save the document in the current folder.

—or—

Click **File > Save As** to save the document in a different folder.

**Note:** You can also use the **Save as** option to save a TI-Nspire™ document as a PublishView™ document.

## Printing PublishView™ Documents

You can print reports, worksheets, and assessments created using the PublishView™ feature. To print a document:

1. Click **File > Print**.

The Print dialog box opens. A preview of the document is shown on the right side of the dialog box.
2. Select a printer from the menu.

**Note:** The **Print what** field is disabled.
3. Select **Paper Size** from the menu. Options are:
  - Letter (8.5 x 11 inches)
  - Legal (8.5 x 14 inches)
  - A4 (210 x 297 mm)



4. Select or type the number of **Copies** you want to print.
5. In the **Print Range** area, select to print all sheets in the document, a range of sheets, or the current sheet only.

**Note:** By default, top and bottom margins are set to one-inch and are maintained when printing a PublishView™ document. There are no side margins. PublishView™ sheets print just as they appear in the workspace.

6. If needed, select or clear the boxes to:
  - Print problem breaks and names.
  - Print headers
  - Print footers
  - Print object borders
7. Click **Print**, or click **Save As PDF**.

## Working with Lesson Bundles

Many lessons or activities contain multiple files. For example, teachers usually have a teacher version of a file, a student version, assessments, and sometimes supporting files. A lesson bundle is a container that enables teachers to group all files needed for a lesson together. Lesson bundles are used to:



- Add any type of file (.tns, .tnsp, .doc, .pdf, .ppt) to a lesson bundle.
- Send lesson bundles to connected handhelds or laptops; however, only the .tns files are sent to the handheld.
- View all the files in a lesson bundle using the TI-Nspire™ software.
- Group all files associated with one lesson in one place.
- Email one lesson bundle file to teachers or students instead of looking for and attaching multiple files.

### ***Creating a New Lesson Bundle***

Teachers and students can create new lesson bundles in the Documents Workspace. Teachers can also create new lesson bundles in the Content Workspace.

#### **Creating a Lesson Bundle in the Documents Workspace**

Complete the following steps to create a new lesson bundle. By default, the new lesson bundle does not contain files.

1. Click  in the Documents Toolbox to open the Content Explorer.
2. Navigate to the folder where you want to save the lesson bundle file.
3. Click  to open the menu, and then click **New Lesson Bundle**.

The new lesson bundle file is created with a default name and placed in your list of files.

4. Type a name for your lesson bundle.
5. Press **Enter** to save the file.

#### **Creating Lesson Bundles in the Content Workspace**

In the Content Workspace, teachers have two options for creating lesson bundles:

- When files needed for a lesson bundle are located in different folders, create an empty lesson bundle, and then add files to the lesson bundle.
- If all needed files are located in the same folder, create a lesson bundle with selected files.

## Creating an Empty Lesson Bundle

Complete the following steps to create a lesson bundle that does not contain files.

1. Navigate to the folder on your computer where you want to save the lesson bundle.

**Note:** If you are using the software for the first time, you may need to create a folder on your computer before creating a lesson bundle.

2. Click  or click **File > New Lesson Bundle**.

The new lesson bundle file is created with a default name and placed in the list of files.

3. Type a name for the lesson bundle and press **Enter**.

The lesson bundle is saved with the new name and details are shown in the Preview pane.

## Creating a Lesson Bundle Containing Files

You can select multiple files within a folder, and then create the lesson bundle. You cannot add a folder to a lesson bundle.

1. Navigate to the folder that contains the files you want to bundle.
2. Select the files. To select multiple files, select the first file then hold down **Shift** and click the last file in the list. To select random files, select the first file, and then hold down **Ctrl** and click the other files to select them.
3. Click , and then click **Lesson Bundles > Create New Lesson Bundle from**

**selected.**

A new lesson bundle is created and placed in the open folder. The lesson bundle contains copies of the selected files.

4. Type a name for the lesson bundle and press **Enter**.

The lesson bundle is saved in the open folder and the details are shown in the Preview pane.

## Adding Files to a Lesson Bundle

Use any of the following methods to add files to a lesson bundle:

- Drag any file into a selected lesson bundle. This method moves the file to the lesson bundle. If you delete the lesson bundle, the file is deleted from your computer. You can recover the file from the Recycle Bin.

- Copy and paste any file into a selected lesson bundle.
- Use the "Add files to lesson bundle" option. This method copies the selected files into the lesson bundle. The file is not moved from its original location.

### Using the Add Files to Lesson Bundle Option

Use this option to add files to an empty lesson bundle or add more files to an existing lesson bundle.

1. Use one of the following options to select the lesson bundle file.
  - When working in the Documents Workspace, open the Content Explorer, and then double-click the lesson bundle file name.
  - When working in the Content Workspace, double-click the lesson bundle name.

**Note:** In the Content Workspace, you can also click the lesson bundle name to open the Files dialog box in the Preview pane. The Add Files to Lesson Bundle option is available from the Files dialog box. If the lesson bundle already contains files, the first file in bundle is shown in the Files dialog box.

The lesson bundle dialog box opens. The name reflects the name of the lesson bundle.

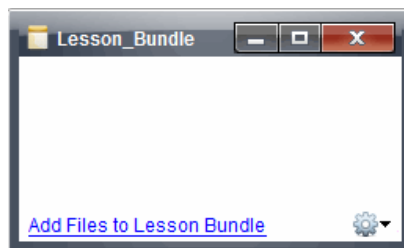

2. Click **Add Files to Lesson Bundle**.

The Add dialog box opens.

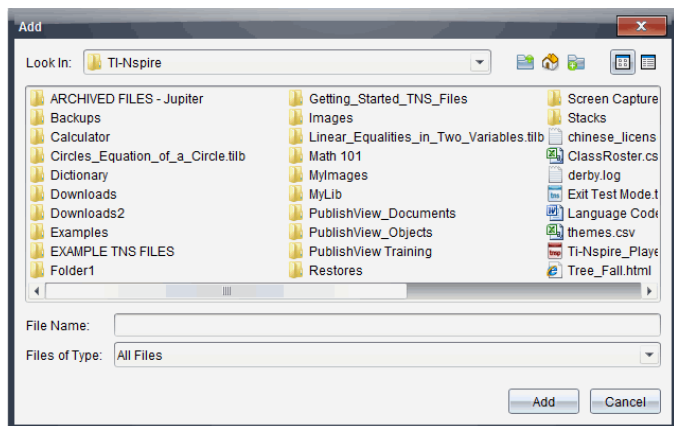

3. Navigate to and select the file you want to add to the lesson bundle.
  - You can select multiple files at one time if they are located in the same folder.
  - If files are located in different folders, you can add them one at a time.
  - You cannot create a folder within a lesson bundle or add a folder to a lesson bundle.
4. Click **Add** to add the file to the bundle.

The file is added to the bundle and is now listed in the lesson bundle dialog box.
5. Repeat this process until all needed files are added to the lesson bundle.

### ***Opening a Lesson Bundle***

To view and work with files within a lesson bundle, complete one of the following steps to open the lesson bundle file.

- ▶ Double-click the lesson bundle name.
- ▶ Select the lesson bundle, and then right-click and click **Open**.
- ▶ Select the lesson bundle, click , and then click **Open**.
- ▶ Select the lesson bundle, and then press Ctrl + O. (Mac®: ⌘ + O).

When you open a lesson bundle, the files in the bundle are displayed in a separate dialog box.

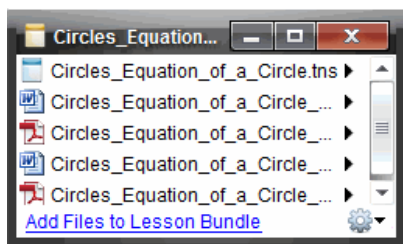

**Note:** You cannot open a lesson bundle outside of the TI-Nspire™ software. For example, if you open the folder using the file manager on your computer and double-click the lesson bundle name, it does not automatically launch the TI-Nspire™ software.

### Opening Files Within a Lesson Bundle

You can open any file within a lesson bundle on your computer if you have the program associated with the file type.

- When you open a .tns or .tnsp file, the file opens in the Documents Workspace in the TI-Nspire™ software.
- When you open another file type, it launches the application or program associated with that file. For example, if you open a .doc file, it opens in Microsoft® Word.

Use one of the following options to open a file within a lesson bundle:

- ▶ Double-click the lesson bundle, and then double-click a file within the lesson bundle.
- ▶ Within a lesson bundle, select the file, and then click ▶ or right-click the file name and select **Open**.

### Managing Files in a Lesson Bundle

You can open, copy/paste, delete, and rename files in an existing lesson bundle. To locate and work with files in an existing lesson bundle:

1. Choose one of the following options to locate an existing lesson bundle.
  - When working in the Documents Workspace, open the Content Explorer (click  in the Documents Toolbox), and then navigate to the folder where the lesson bundle is located.
  - When working in the Content Workspace, navigate to the folder where the lesson bundle is located in Content pane.

**Note:** When you click a lesson bundle name in the Content pane, the Files dialog box opens in the Preview pane. Select a file and right-click to open the context menu.

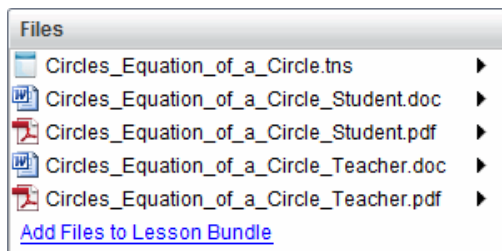

2. Double-click the lesson bundle name to open the Lesson Bundle dialog box.

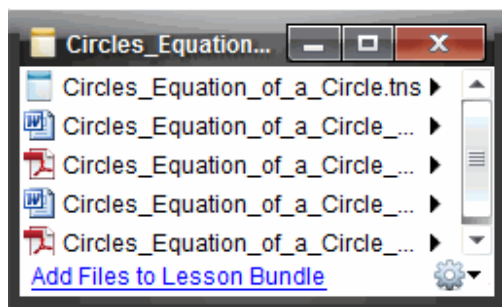

3. Select the file you want to work with and click ► to open the context menu.

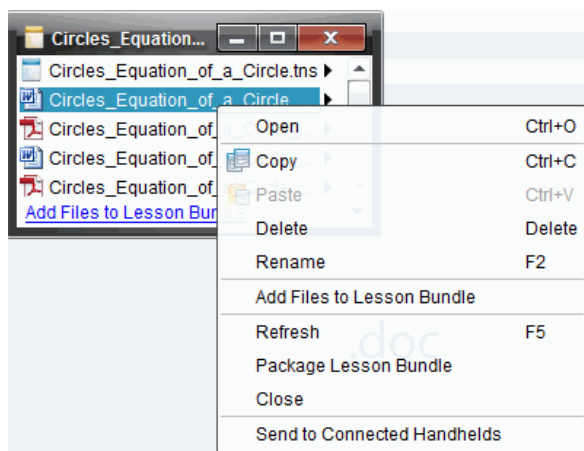

4. Click the action you want to perform:
  - Click **Open**. TI-Nspire™ and PublishView™ documents open in the Documents Workspace. When you open another file type, it launches the application or program associated with that file.
  - Click **Copy** to place the file in the Clipboard.

- Navigate to a folder on your computer or select a connected handheld or laptop, and then right-click and click **Paste** to place the copied file in a new location.
- Click **Delete** to delete a file from the lesson bundle. Use caution when deleting a file from a lesson bundle. You should ensure files contained in the bundle are backed up if you need the files for future use.
- Click **Rename** to give the file a new name. To cancel this action, press **Esc**.
- Click **Add Files to Lesson Bundle** to select and add files to the bundle.
- Click **Refresh** to update the list of files in the bundle.
- Click **Package Lesson Bundle** to create a .tilb file
- Click **Send to Connected Handhelds** to open the Transfer Tool and send the selected file to connected handhelds. You can send .tns files and OS files.

5. When finished, click **Close** to close the dialog box.

## Managing Lesson Bundles

Use the options menu or the context menu to copy, delete, rename, or send a lesson bundle to connected handhelds or laptops. You cannot add a folder to a lesson bundle.

### Managing Lesson Bundles in the Documents Workspace

1. Open the Content Explorer, and then right-click the lesson bundle name or click  to open the context menu.

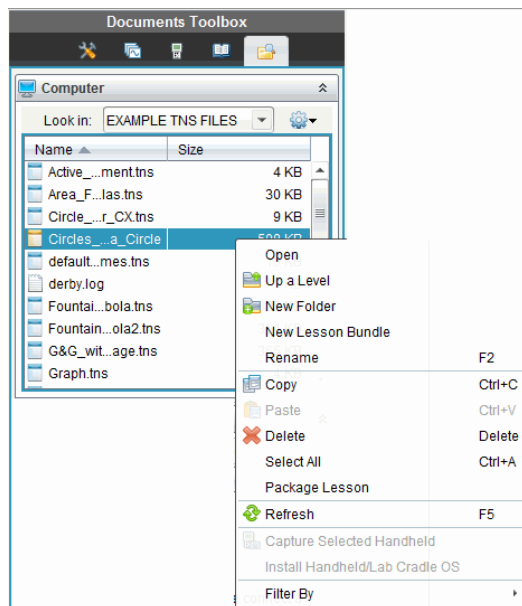







2. Click the action you want to perform. If an action is not available, it is dimmed.
  - Click **Open** to open the lesson bundle.
  - Click **Up One Level** to navigate up a level in the folder hierarchy.
  - You cannot add a folder to a lesson bundle. If you click **New Folder**, a new folder is added to the folder where the lesson bundle is stored.
  - Click **New Lesson Bundle** to create a new lesson bundle. The new lesson bundle is not added to the existing lesson bundle—it is created in the same folder as the existing lesson bundle.
  - Click **Rename** to change the name of the lesson bundle. Press **Esc** to cancel this action.
  - Click **Copy** to copy the lesson bundle to the Clipboard.
  - Navigate to another folder, and then click **Paste** to copy the lesson bundle in another location.
  - Click **Delete** to delete the lesson bundle. Use caution when deleting a lesson bundle. You should ensure files contained in the bundle are backed up if you need the files for future use.
  - **Select All** highlights all files in the open folder. This action does not apply to lesson bundles.
  - Click **Package Lesson** to create a .tilb file.
  - Click **Refresh** to update the list of files in the open folder.

### **Managing Lesson Bundles in the Content Workspace**

1. Click **Computer Content** in the Resources pane.
2. In the Content pane, navigate to the lesson bundle you want to work with, and then right-click to open the context menu or click  to open the menu of options.

Open	Ctrl+O
 Copy	Ctrl+C
 Paste	Ctrl+V
 Delete	Delete
Refresh	Ctrl+R
Rename	F2
 Up a Level	Alt+Up
 New Folder	Ctrl+Shift+N
Create Shortcut...	
Lesson Bundles	▶
Send to Connected Handhelds	
Filter by	▶

### 3. Select the action you want to perform:

- Click **Open** to open the lesson bundle.
- Click **Copy** to place the lesson bundle file in the Clipboard.
- Navigate to a folder on your computer or select a connected handheld, and then right-click and click **Paste** to place the copied file in a new location.
- Click **Delete** to delete the lesson bundle. Use caution when deleting a lesson bundle. You should ensure files contained in the bundle are backed up if you need the files for future use.
- Click **Refresh** to update the list of files in the bundle.
- Click **Rename** to give the lesson bundle a new name. To cancel this action, press **Esc**.
- To move up a level in the folder hierarchy, click **Up a Level**.
- To add the lesson bundle to the list of shortcuts in Local Content, click **Create Shortcut**.
- To add more files to the lesson bundle, click **Lesson Bundles > Add Files to Lesson Bundle**.
- Click **Lesson Bundles > Package Lesson Bundle** to create a .tilb file.
- Click **Send to Connected Handhelds** to open the Transfer Tool and send the lesson bundle to connected handhelds.

## Packaging Lesson Bundles

Packaging lesson bundles creates a "package" folder with a .tilb file. This file contains all files contained in the lesson bundle. You must package the lesson before you can email the lesson bundle (.tilb file) to colleagues or students. By default, the lesson

bundle is saved in the following folder:  
...\\TI-Nspire\\New Lesson Bundle1.tilb\\package\\...

### Packaging a Lesson in the Documents Workspace

1. Open the Content Explorer.
2. Navigate to the folder where the lesson bundle is saved.
3. Select the lesson bundle you want to package.
4. Right-click to open the context menu, and then click **Package Lesson**.

The Lesson Bundle dialog box opens confirming that the .tilb file was created and the lesson bundle was successfully packaged.

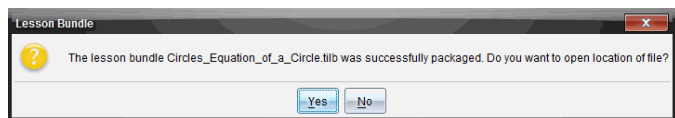

5. Click **Yes** to open the folder where the lesson package is stored. Click **No** to close the dialog box.

### Packaging a Lesson in the Contents Workspace

1. In **ComputerContent**, navigate to the folder that contains the lesson bundle you want to package.
2. Click the lesson bundle in the Content pane. The Lesson Bundle details are displayed in the Preview pane.
3. Use one of the following methods to create the package:
  - From the Preview pane, click ► in the Files dialog box, and then click **Package Lesson Bundle**.
  - From the Content pane, right-click the lesson bundle name, and then click **Lesson Bundles > Package Lesson Bundle**.

The Lesson Bundle dialog box opens confirming that the lesson bundle was created.

4. Click **Yes** to open the folder where the lesson package is stored. Click **No** to close the dialog box.

### Emailing a Lesson Bundle

After a lesson bundle is packaged, you can email the .tilb file to other teachers or students. To attach the lesson bundle to an email:

1. In your email client, select the option needed to attach a file, and then navigate to the .tilb folder.
2. Make sure you open the folder and select the .tilb file to attach to the email. You cannot email the .tilb folder.

### ***Sending Lesson Bundles to Connected Handhelds***

1. Complete one of the following actions to select a lesson bundle:
  - In the Documents Workspace, open the Content Explorer, and then select the lesson bundle you want to send.
  - In the Content Workspace, navigate to the lesson you want to send in the Content pane.
2. Drag the lesson bundle file to a connected handheld. You can also copy the lesson bundle, and then paste it to a connected handheld.

The lesson bundle is transferred to the handheld as a folder with the same name. Only .tns files are transferred to the handheld.

# Capturing Screens

Screen Capture enables you to:

- **Capture Page**
  - Capture the active page in a TI-Nspire™ document from the software or from the TI-SmartView™ emulator as an image.
  - Save captured images as .jpg, .gif, .png, or .tif files, which can be inserted into TI-Nspire™ applications that allow images.
  - Copy and paste images into another application such as Microsoft® Word.
- **Capture Selected Handheld**
  - Capture the current screen on a connected handheld as an image.
  - Save captured images as .jpg, .gif, .png, or .tif files, which can be inserted into TI-Nspire™ applications that allow images.
  - Copy and paste images into another application such as Microsoft® Word.
- **Capture Images in Handheld Mode**
  - In the Documents Workspace, use the DragScreen feature to capture the emulator screen or side screen when the TI-SmartView™ Emulator is active.
  - Teachers can use this feature to drag and paste an image to presentation tools such as SMART® Notebook, Promethean's Flipchart, and Microsoft® Office applications including Word and PowerPoint®.

For web-based connectivity using your TI-Nspire™ CX II with a Chromebook, Windows® computer, or Mac® computer, go to [TI-Nspire™ CX II Connect](#).

## Accessing Screen Capture

The Screen Capture tool is available from all workspaces. To access Screen Capture:

- ▶ From the menu bar, click **Tools > Screen Capture**.
- ▶ From the toolbar, click .

## Using Capture Page

Use the Capture Page option to capture an image of an active page in a TI-Nspire™ document. You can save images in the following file formats: .jpg, .gif, .png, and .tif. Saved images can be inserted into TI-Nspire™ applications that allow images. The image is also copied to the Clipboard and can be pasted into other applications such as Microsoft® Word or PowerPoint®.

### Capturing a Page

Complete the following steps to capture an image of an active page.

1. In the Documents Workspace, open a document and navigate to the page you want to capture to make it active.

2. Click , and then click **Capture Page**.

The image of the active page is copied to the Clipboard and to the Screen Capture window.

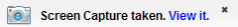
The  dialog box opens in the lower right corner of your desktop when the screen capture is complete.

3. Click **View it**.

The Screen Capture window opens.

You can also click **Window > Screen Capture Window** to open the Screen Capture window.

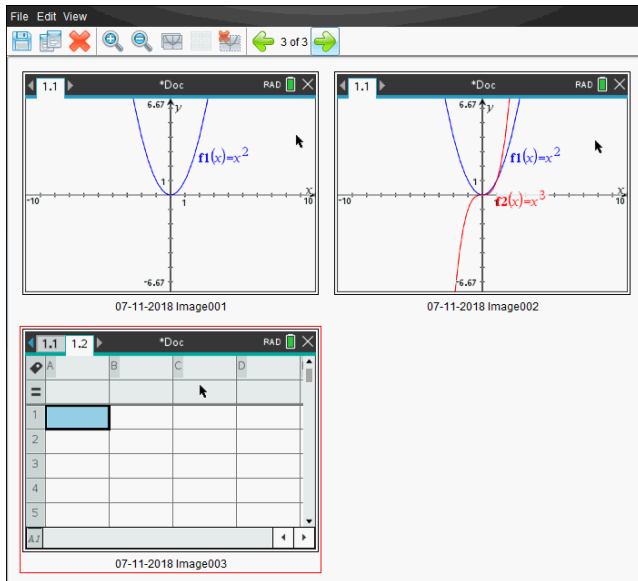

4. To capture additional pages, move to another page in the current document or open a new document to select a page.

As you capture additional pages, the images are copied to the Screen Capture window, which holds multiple images. The last page captured replaces the contents of the Clipboard.

## Using Capture Selected Handheld

Use the Capture Selected Handheld option to capture the active screen on a connected handheld.

1. On a connected handheld, navigate to the menu or to a page in a document you want to capture.
2. In the software, select the connected handheld:

- In the Content Workspace, select the handheld from the list of Connected Handhelds in the Resources pane.
  - In the Documents Workspace, open Content Explorer from the Documents Toolbox, and then select the handheld from the list of Connected Handhelds.
  - In the Class Workspace, select a logged in student.
3. Click , and then click **Capture Selected Handheld**.

—or—

Click , and then click **Capture Selected Handheld**.

The screen is copied to the Clipboard and to the TI-Nspire™ Screen Capture

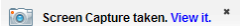
window. The  dialog box opens in the lower right corner of your desktop when the screen capture is complete.

4. Click **View it**.

The Screen Capture window opens.

You can capture additional screens from an open document on a connected handheld or open another document on a connected handheld to capture screens from that document.

As you capture additional screens, the images are copied to the Screen Capture window, which holds multiple images. The last screen captured replaces the contents of the Clipboard.

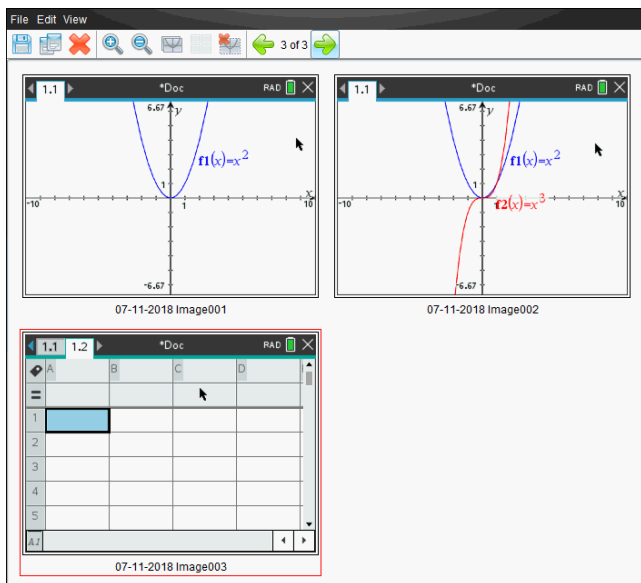

## ***Viewing Captured Screens***

When you capture a page or screen, it is copied to the Screen Capture window.



## Zooming the View of Captured Screens

In the Screen Capture window, use the zoom in and zoom out options to increase or decrease the size of the captured screens.

- ▶ From the toolbar, click  to increase the size of the screens in the view. You can also click **View > Zoom In** from the menu.
- ▶ From the toolbar, click  to decrease the size of the screens in the view. You can also click **View > Zoom Out** from the menu.

## Saving Captured Pages and Screens

You can save captured pages and screens captured as images for use in other TI-Nspire™ documents that allow images or for use in other applications such as Microsoft® Word. You can save one image at a time, select multiple images to save, or save all captured images.

### Saving Selected Screens

1. In the Screen Capture window, select the screen image you want to save.
2. Click **File > Save Selected Screen(s)**.

**Note:** From the Screen Capture window, you can also click .

The Save as dialog box opens.



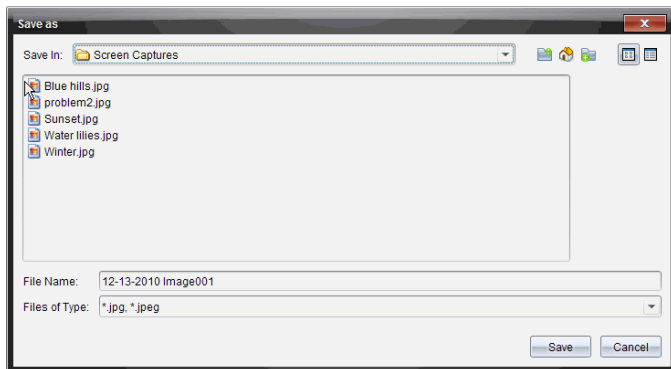

3. Navigate to the folder on your computer where you want to save the file.
4. Type a name for the file.  
**Note:** The default file name is *MM-DD-YYYY Image ###*.
5. Select the file type for the image file. The default format is .jpg. Click ▼ to select another format: .gif, .tif, or .png.
6. Click **Save**.

The file is saved in the designated folder.

### Saving Multiple Screens

1. In the Screen Capture window, select the screens you want to save.  
To select multiple consecutive screens, click the first image, and then hold down the **Shift** key and click the additional images. To select screens in random order, press **Ctrl** (Mac®: **⌘**) and click each image you want to save.
2. Click  or select **File > Save Selected Screen(s)**. To save all captured screens, select **File > Save All Screens**.

**Note:** The "Save All Screens" option is not available when using Capture Class.

The Save as dialog box opens.

3. In the Save In field, navigate to the folder where you want to save the images.
4. In the File Name field, type a new folder name. The default folder name is *MM-DD-YYYY Image*, where *MM-DD-YYYY* is the current date.

5. Select the file type for the image files. The default format is .jpg. Click ▼ to select another format: .gif, .tif, or .png.
6. Click **Save**.

The images are saved in the specified folder with system-assigned names reflecting the current date and a sequence number. For example, *MM-DD-YYYY Image 001.jpg*, *MM-DD-YYYY Image 002.jpg* and so on.

## ***Copying and Pasting a Screen***

You can select a captured screen and copy it to the Clipboard for inclusion into other documents or applications. You can also print copied screens. Copied screens are captured at 100% zoom level, and they are copied in the order of selection.

### **Copying a Screen**

1. Select the screen to copy.
2. Click  or **Edit > Copy**.

The selected screen is copied to the Clipboard.

### **Pasting a Screen**

Depending on the application you are pasting to, click **Edit > Paste**.

**Note:** You can also drag a screen capture to another application. This functions as a copy and paste.

## ***Capturing Images in Handheld Mode***

In the Documents Workspace, use the DragScreen feature to capture the emulator screen or side screen when the TI-SmartView™ Emulator is active.

Teachers can use this feature to drag and paste an image to presentation tools such as SMART® Notebook, Promethean's Flipchart, and Microsoft® Office applications including Word and PowerPoint®.

### **Capturing Images Using the DragScreen Feature**

Complete the following steps to capture an image and copy it to a third-party application.

1. From the Documents Workspace, click , which is located in the Documents Toolbox.

The TI-SmartView™ Emulator opens.

- If the display selected is **Handheld + SideScreen**, the current document is shown in the emulator and in the side screen.
- If the display selected is **Keypad + SideScreen**, the current document is shown in the side screen.

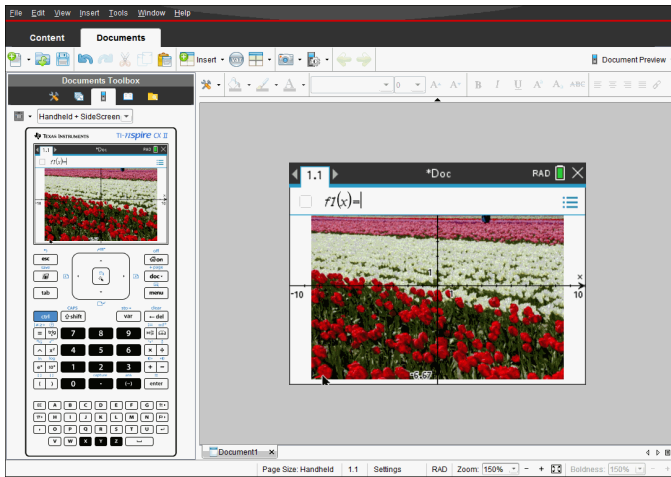

- To start the screen capture, click the area above the emulator screen or above the keypad. In the **Handheld + SideScreen** display, you can also click the area around the emulator screen.

Do not release the mouse button. If the cursor is active or if you click inside the emulator window, the screen capture is not started.

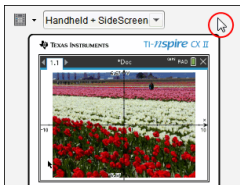

In **Handheld + SideScreen** view, click the area above the emulator, click the area around the emulator, or click the border of the emulator screen to start the screen capture.

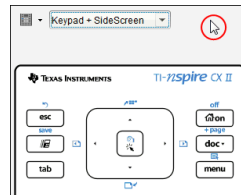

In **Keypad + SideScreen** view, click the area above the keypad to start the screen capture.

- Without releasing the mouse, drag the image.

A ghost image of the captured screen opens. The ghost image remains visible until you release the mouse button.

The  in the corner of the ghost image indicates you cannot paste the image in that location.

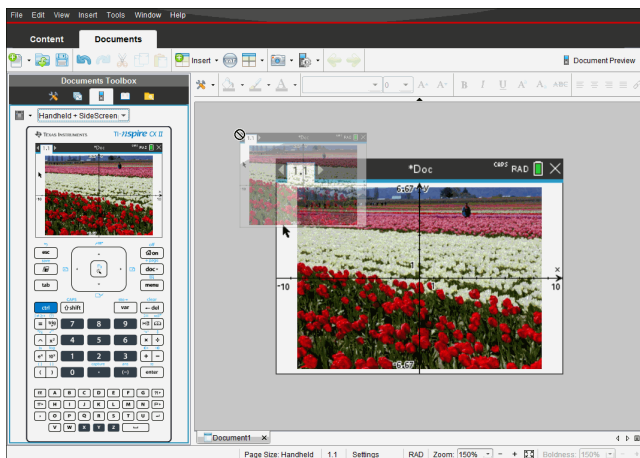

4. Drag the image to an open third-party application. When the image is on top of the third-party application, the **+** indicates you can drop the image.
5. Release the mouse button to drop the image into the selected application.

The image is also copied to the Clipboard and to the TI-Nspire™ Screen Capture window.

To view captured images in the Screen Capture window, click **Window > Screen Capture Window**.

You can capture additional screens as needed. As you capture additional screens, the images are copied to the Screen Capture window, which holds multiple images. The last screen captured replaces the contents of the Clipboard.

## Working with Images

Images can be used in TI-Nspire™ applications for reference, assessment, and instructional purposes. You can add images to the following TI-Nspire™ applications:

- Graphs & Geometry
- Data & Statistics
- Notes
- Question, including Quick Poll

In the Graphs & Geometry and Data & Statistics applications, images are set in the background behind the axis and other objects. In the Notes and Question applications, the image is set at the cursor location inline with the text (in the foreground).

You can insert the following image file types: .jpg, .png, or .bmp.

**Note:** The transparency feature of a .png file type is not supported. Transparent backgrounds are displayed as white.

### *Working with Images in the Software*

When working in the TI-Nspire™ software, you can insert, copy, move, and delete images.

#### **Inserting Images**

In the Notes and Question applications, and in Quick Poll, you can insert more than one image on a page. You can only insert one image on a page in the Graphs & Geometry and Data & Statistics applications.

1. Open the document where you want to add an image.
2. Click **Insert > Image**.

The Insert Image dialog box opens.

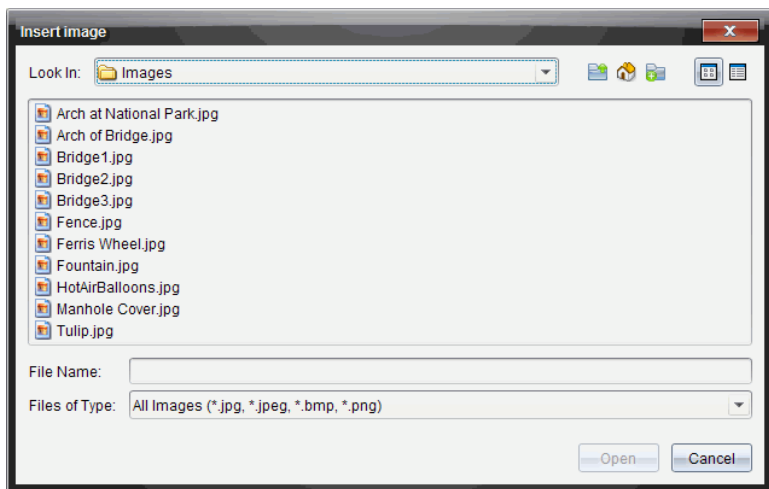



3. Navigate to the folder where the image is located and select the image.
4. Click **Open**.
  - In the Graphs & Geometry and Data & Statistics applications, the image is inserted in the background behind the axis.
  - In Notes, Question, and Quick Poll, the image is inserted at the cursor location. You can type text above or below the image, and you can move the image up or down on the page.

**Note:** You can also insert images by copying an image to the Clipboard and pasting it into the application.

### Moving Images

In applications such as Notes and Question where the image is set at the cursor location, you can reposition the image by moving the image to a new line or blank space, or by placing the image within a line of text. In the Graphs & Geometry and Data & Statistics applications, images can be moved to any position on the page.

1. Select the image.
  - In the Notes and Question applications, click the image to select it.
  - In the Graphs & Geometry and Data & Statistics applications, right-click the image, and then click **Select > Image**.
2. Click the selected image and hold the mouse button.

- If an image is in the foreground, the cursor changes to .
  - If an image is in the background, the cursor changes to .
3. Drag the image to the new location and release the mouse button to place the image.

If an image is in the foreground, the cursor changes to  when you hover your mouse pointer over a location where there is a new line or space. Images in the background can be moved and placed anywhere on the page.

## Resizing Images

To retain the aspect ratio of an image, resize by grabbing the image at one of the four corners.

1. Select the image.
  - In the Notes and Question applications, click the image to select it.
  - In the Graphs & Geometry and Data & Statistics applications, right-click the image, and then click **Select > Image**.
2. Move the cursor to one of the corners of the image.

The cursor changes to  (a four-sided directional arrow).

**Note:** If you drag the cursor to an edge of the image, the cursor changes to  (a two-sided directional arrow). If you drag an image from one of its edges to resize it, the image becomes distorted.

3. Click the corner or edge of the image.

The  tool is enabled.

4. Drag in to make the image smaller or drag out to make the image larger.
5. Release the mouse when the image size is correct.

## Deleting Images

To delete an image from an open document, complete the following steps.

1. Select the image.
  - If an image is in the foreground, click the image to select it.
  - If an image is in the background, right-click the image, and then click **Select > Image**.

2. Press **Delete**.

The image is removed.







## Responding to Questions

The teacher may send you several different question types. This section shows you how to answer the different question types.

### ***Understanding the Question Toolbar***

When you open a document with a question, a toolbar is available with four options. Access the toolbar using the following method.

- ▶ In the Documents Toolbox, click  .  
Handheld: press .

Tool name	Tool function
 Clear Answers	Lets you clear the answers in the current question or in the document.
 Check Answer	If the teacher enabled Self-Check mode for the question, click here to view the correct answer.
 Insert	Lets you insert a math expression box or chemical equation box in your answer.
 Format	Click this tool to format the selected text in your answer as subscript or superscript. (The chemical equation box uses its own formatting tool, so this Format tool does not work in the chemical equation box.)

### ***Types of Questions***

There are several types of questions you may be asked. There may be variations in a type, but how you answer the question is basically the same for each type.

- Multiple Choice
  - Custom
  - ABCD
  - True/False
  - Yes/No
  - Always/Sometimes/Never
  - Agree/Disagree
  - Strongly Agree...Strongly Disagree
- Open response
  - Explanation (not auto-graded)
  - Text Match (auto-graded)

- Equations and Expressions
  - $y=$
  - $f(x)=$
  - Expression
- Coordinate Points and Lists
  - $(x,y)$  numerical input
  - Drop Point(s)
  - List(s)
- Image
  - Label
  - Point on
- Chemistry

### ***Responding to Quick Poll Questions***

When teachers send quick polls during class, the question opens as a new document on top of any document you may currently have open. You can access other applications to perform calculations, and check or clear answers before submitting your answer to the question or quick poll.

**Note:** On TI-Nspire™ CX or TI-Nspire™ CX CAS handhelds, questions appear in color if the teacher applied color when writing the question. Although you can see color in the questions you receive, you cannot add color to the responses you submit.

### **Accessing Other Applications**

If the teacher gives permission, the Quick Poll tool allows you to temporarily exit the question to perform calculations or access other documents to determine the answer to the question. For example, you can access the Scratchpad to perform a calculation, or you can access the Lists & Spreadsheet application and copy data from there to a List question type. In a List question, you can link to variables from the Vernier DataQuest™ or Lists & Spreadsheet applications.

To access other applications while in the Quick Poll screen:

1. Open a new document.

Handheld: Press  to open the **Home** screen.

2. Choose an application.

Handheld: To return to the Quick Poll without accessing any documents, choose **C: Quick Poll**.

3. When you are finished, click the Quick Poll icon.

When you respond to a poll, your response is immediately sent to the teacher's computer and teachers can track student responses in real time.

## Showing Your Work

The teacher may request you to show work for your response. If so, the response area has sections for you to write your starting point, your steps, and the final answer.

### Responding to Different Question Types

- ▶ For Multiple Choice questions, press **Tab** to navigate to a response. Press **Enter** to mark a response.
- ▶ For Open Response questions, type a response.
- ▶ For Equation questions, type a response. If a graph is included in a question, the graph updates when you press **Enter**. Any functions entered show up on the graph, and the cursor remains in the answer box. You cannot manipulate the graph itself.
- ▶ For Expression questions, type a response. If the response type is Number, your response must be in the form of a number. If the response type is Expression, your response must be in the form of an expression. For example,  $x+1$ .
- ▶ For Coordinate Points: (x,y) questions, type an answer in the x-field box, and press **Tab** to move to the y-field box. Type an answer.

If a graph is included with the question, the graph is updated when you enter a function and press **Enter**.

You can access the Window and Zoom functions while you are working on the graph.

- ▶ For Coordinate Points: Drop Points questions, press **Tab** to move the cursor to a point on the graph. Press **Enter** to drop a point at that location.

To delete a point, press **Ctrl + Z** to undo the action.

- ▶ For Lists questions, press **Tab** if necessary to move the cursor to the first cell of the list. Type an answer, and press **Tab** to move to the next cell. Type an answer.

To link a column to an existing variable, select the column and then click **var**. Click **Link To**, and then click the variable you want to link to.

The behavior in a Lists question closely matches the behavior of the Lists & Spreadsheet application, with the following exceptions. In a Lists question, you cannot:

- Add, insert, or delete columns.
  - Change the header row.
  - Enter formulas.
  - Switch to Table.
  - Create plots.
- ▶ For Chemistry questions, type a response.
  - ▶ For Image: Label questions, press **Tab** to move the cursor to a label on the image. Type a response in the label field.

- ▶ For Image: Point on questions, press **Tab** to move the cursor to a point on the image. Press **Enter** to mark a response.

### Checking Answers

If the teacher enables self-check on the question, the Check Answer option is available.

1. Click .

Handheld: Press **menu**.

2. Click **Check Answer**.

### Clearing Answers

After you answer a quick poll, you may decide you want to change the answer before you submit it.

- ▶ Click **Menu > Clear Answers > Current Question** or **Document**.
  - **Current Question** clears answers for the active question.
  - **Document** clears answers for all questions contained in the active document.

—or—

If you answered the question, you still have time to clear the answer before you submit it to your teacher.

- ▶ Click **Clear Answer** to clear your answer and try again.

Handheld: Press **doc v** and choose **Clear Answer**.

### Submitting Responses

To send a final answer to the teacher:

- ▶ Click **Submit Response**.

Handheld: Press **doc v** and choose **Submit**.

The response is sent to the teacher and the last screen you used is displayed.

Your response appears on the teacher's computer. Your teacher may have set the poll to allow you to submit more than one answer. If so, you can continue to respond to the poll and submit answers until the teacher stops the poll.

# Calculator Application

The Calculator application lets you:

- Enter and evaluate math expressions
- Define variables, functions, and programs that become available to any TI-Nspire™ application—such as the Graphs application—residing in the same problem.
- Define library objects, such as variables, functions, and programs, which are accessible from any problem of any document. For information on creating library objects, see *Libraries*.

## Adding a Calculator Page

- ▶ To start a new document with a blank Calculator page:

From the main **File** menu, click **New Document**, and then click **Add Calculator**.

Handheld: Press **[on]**, and select **Calculator** **[x=]**.

- ▶ To add a Calculator page in the current problem of an existing document:

From the toolbar, click **Insert > Calculator**.

Handheld: Press **[doc v]** and select **Insert > Calculator**.

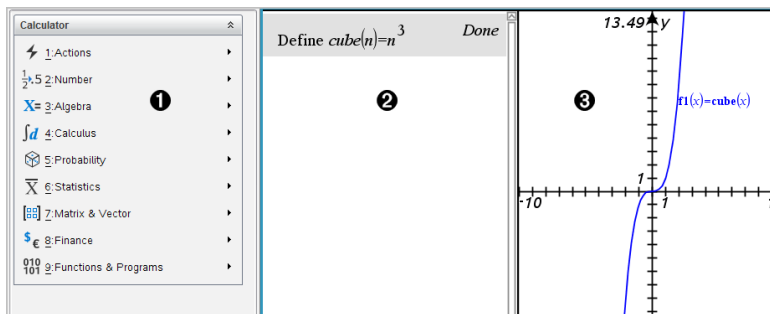

- 1 Calculator menu.** This menu is available anytime you are in the Calculator work area using the Normal view mode. The menu in this screen snapshot may not exactly match the menu on your screen.
- 2 Calculator work area**
  - Enter a math expression on the entry line, and then press **Enter** to evaluate the expression.
  - Expressions are displayed in standard mathematical notation as you enter them.
  - Entered expressions and results show in the Calculator history.
- 3 Example of Calculator variables used in another application.**

## Entering and Evaluating Math Expressions

### Entering Simple Math Expressions

**Note:** To enter a negative number on the handheld, press  $\boxed{(-)}$ . To enter a negative number on a computer keyboard, press the hyphen key (-).

$$\frac{2^8 \cdot 43}{12}$$

Suppose you want to evaluate  $\frac{2^8 \cdot 43}{12}$

1. Select the entry line in the Calculator work area.
2. Type  $2^8$  to begin the expression.



A horizontal line representing a calculator display with the text "2^8" on the left side.

3. Press  $\blacktriangleright$  to return the cursor to the baseline.
4. Complete the expression:

Type  $*43/12$ .

Handheld: Type  $\boxed{\times}$   $43$   $\boxed{\div}$   $12$ .



A horizontal line representing a calculator display with the text "2^8 \* 43 / 12" on the left side.

5. Press **Enter** to evaluate the expression.

The expression is displayed in standard mathematical notation, and the result is displayed on the right side of the Calculator.



A horizontal line representing a calculator display. On the left side, the fraction  $\frac{2^8 \cdot 43}{12}$  is shown. On the right side, the fraction  $\frac{2752}{3}$  is shown.

**Note:** If a result does not fit on the same line with the expression, it is displayed on the next line.

### Controlling the Form of a Result

You might expect to see a decimal result instead of  $2752/3$  in the preceding example. A close decimal equivalent is  $917.33333\dots$ , but that's only an approximation.



By default, Calculator retains the more precise form:  $2752/3$ . Any result that is not a whole number is shown in a fractional or exact (Exact Arithmetic and CAS) form, or symbolic form (CAS). This reduces rounding errors that could be introduced by intermediate results in chained calculations.

You can force a decimal approximation in a result:

- By pressing shortcut keys.

Windows®: Press **Ctrl+Enter** to evaluate the expression.

Mac®: Press **⌘+Enter** to evaluate the expression.

Handheld: Press   instead of  to evaluate the expression.

$$\frac{2^{8.43}}{12} \qquad 917.333$$

Pressing   forces the approximate result.

- By including a decimal in the expression (for example, **43.** instead of **43**).



$$\frac{2^{8.43.}}{12} \qquad 917.333$$

- By wrapping the expression in the **approx()** function.

$$\text{approx}\left(\frac{2^{8.43}}{12}\right) \qquad 917.333$$

- By changing the document's **Auto or Approximate** mode setting to Approximate.

From the **File** menu, click **Settings > Document Settings**.

Handheld: Press  to display the **File** menu.

Note that this method forces all results in all of the document's problems to approximate.

## Inserting Items from the Catalog

You can use the Catalog to insert system functions and commands, symbols, and expression templates into the Calculator entry line.

1. Click the **Utilities** tab, and then click  to open the Catalog.

Handheld: Press  **1**.

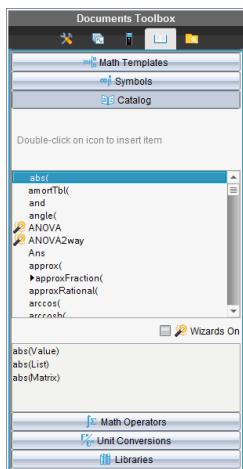

**Note:** Some functions have a wizard that prompts you for each argument. Those functions are shown with an indicator. To receive the prompts, select **Wizards On**.

2. If the item you are inserting is visible in the list, select it and press **Enter** to insert it.
3. If the item is not visible:
  - a) Click inside the list of functions, and then press a letter key to jump to the entries that begin with that letter.
  - b) Press **▲** or **▼** as necessary to highlight the item you are inserting.  
 Help, such as syntax information or a short description of the selected item, appears at the bottom of the Catalog.
  - c) Press **Enter** to insert the item into the entry line.

### Using an Expression Template

The Calculator has templates for entering matrices, piecewise functions, systems of equations, integrals, derivatives, products, and other math expressions.

$$\sum_{n=1}^7 (n)$$

For example, suppose you want to evaluate  $n=3$

1. On the **Utilities** tab, click  to open the templates.



Handheld: Press  $\left[ \frac{\square}{\square} \right]$ .

2. Double-click  $\sum_{\square}^{\square} (\square)$  to insert the algebraic sum template.

The template appears on the entry line with small blocks representing elements that you can enter. A cursor appears next to one of the elements to show that you can type a value for that element.

---

$$\sum_{\square}^{\square} (\square)$$

---

3. Use the arrow keys to move the cursor to each element's position, and type a value or expression for each element.

---

$$\sum_{n=3}^7 (n)$$

---

4. Press **Enter** to evaluate the expression.

---

$$\sum_{n=3}^7 (n) \quad 25$$

---

### Creating Matrices

1. On the **Utilities** tab, click  $\left[ \begin{smallmatrix} \square & \square \\ \square & \square \end{smallmatrix} \right]$  to open the templates.

Handheld: Press  $\left[ \frac{\square}{\square} \right]$ .

2. Double-click  $\left[ \begin{smallmatrix} \square & \square \\ \square & \square \end{smallmatrix} \right]$ .

The Create a Matrix dialog box opens.

**Create a Matrix**

Number of rows:   $\left[ \begin{smallmatrix} \uparrow \\ \downarrow \end{smallmatrix} \right]$

Number of columns:   $\left[ \begin{smallmatrix} \uparrow \\ \downarrow \end{smallmatrix} \right]$

3. Type the **Number of rows**.

4. Type the **Number of columns**, and then click **OK**.

Calculator opens a template with spaces for the rows and columns.

**Note:** If you create a matrix with a large number of rows and columns, it may take a few moments to appear.

5. Type the matrix values into the template, and then press **Enter** to define the matrix.

### Inserting a Row or Column into a Matrix

- ▶ To insert a new row, hold down **Alt** and press **Enter**.
- ▶ To insert a new column, hold down **Shift** and press **Enter**.

Handheld:

- ▶ To insert a new row, press .
- ▶ To insert a new column, press **Shift+Enter**.

### Inserting Expressions Using a Wizard

You can use a wizard to simplify entering some expressions. The wizard contains labeled boxes to help you enter the arguments in the expression.

For example, suppose you want to fit a  $y = mx + b$  linear regression model to the following two lists:

{1,2,3,4,5}

{5,8,11,14,17}

1. On the **Utilities** tab, click  to open the Catalog.

Handheld: Press  **1**.

2. Click an entry in the Catalog, and then press **L** to jump to the entries that begin with “L.”
3. Press **▼** as necessary to highlight **LinRegMx**.
4. Select the **Wizards On** option, if it is not already selected:

Handheld: Press **Tab Tab** to highlight **Wizards On**, press **Enter** to change the setting, and then press **Tab Tab** to highlight **LinRegMx** again.

5. Press **Enter**.

A wizard opens, giving you a labeled box to type each argument.

**Linear Regression (mx+b)**

X List:  ▶

Y List:  ▶

Save RegEqn to:  ▶

Frequency List:  ▶

Category List:  ▶

Include Categories:  ▶

6. Type {1, 2, 3, 4, 5} as X List.
7. Press **Tab** to move to the Y List box.
8. Type {5, 8, 11, 14, 17} as Y List.
9. If you want to store the regression equation in a specific variable, press **Tab**, and then replace **Save RegEqn To** with the name of the variable.
10. Click **OK** to close the wizard and insert the expression into the entry line.

Calculator inserts the expression and adds statements to copy the regression equation and show the variable *stat.results*, which will contain the results.

```
LinRegMx {1,2,3,4,5},{5,8,11,14,17},1: CopyVar stat.RegEqn,f2: stat.results
```

Calculator then shows the *stat.results* variables.

```
LinRegMx {1,2,3,4,5},{5,8,11,14,17},1: stat.results
```

"Title"	"Linear Regression (mx+b)"
"RegEqn"	"m*x+b"
"m"	3.
"b"	2.
"r <sup>2</sup> "	1.
"r"	1.
"Resid"	" {... }"

**Note:** You can copy values from the *stat.results* variables and paste them into the entry line.

## Creating a Piecewise Function

1. Begin the function definition. For example, type the following expression:

**Define**  $f(x, y) =$

2. On the **Utilities** tab, click  $\left\{ \begin{array}{l} \square \\ \square \\ \square \end{array} \right\}$  to open the templates.

Handheld: Press  $\left[ \left\{ \begin{array}{l} \square \\ \square \\ \square \end{array} \right\} \right]$ .

3. Double-click  $\left\{ \begin{array}{l} \square \\ \square \\ \square \end{array} \right\}$ .

The Create Piecewise Function dialog box opens.

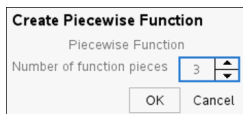

4. Type the **Number of Function Pieces**, and click **OK**.

Calculator opens a template with spaces for the pieces.

5. Type the expressions into the template, and press **Enter** to define the function.
6. Enter an expression to evaluate or graph the function. For example, type the expression  $f(1, 2)$  on the Calculator entry line.

## Creating a System of Equations

1. On the **Utilities** tab, click  $\left\{ \begin{array}{l} \square \\ \square \\ \square \end{array} \right\}$  to open the templates.

Handheld: Press  $\left[ \left\{ \begin{array}{l} \square \\ \square \\ \square \end{array} \right\} \right]$ .

2. Double-click  $\left\{ \begin{array}{l} \square \\ \square \\ \square \end{array} \right\}$ .

The Create a System of Equations dialog box opens.

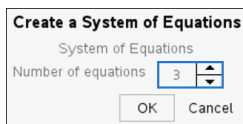

3. Type the **Number of Equations**, and click **OK**.

Calculator opens a template with spaces for the equations.

4. Type the equations into the template, and press **Enter** to define the system of equations.

## Entering Multiple Statements on the Entry Line

To enter several statements on a single line, separate them with a colon (":"). Only the result of the last expression is shown.

---

$$a:=5: b:=2: \frac{a}{b} \cdot 1. \qquad 2.5$$

---

## CAS: Working with Measurement Units

A list of pre-defined constants and measurement units is available in the Catalog. You can also create your own units.

**Note:** If you know a unit's name, you can type the unit directly. For example, you can type `_qt` to specify quarts. To type the underscore symbol on the handheld, press

 .

### CAS: Converting Between Measurement Units

You can convert a value between any two units within the same category (such as length).

Example: Using the Catalog, convert 12 meters to feet. The desired expression is `12*_m ►_ft`.

1. Type **12** on the entry line.
2. On the **Utilities** tab, click  to show the unit conversions.

Handheld: Press  **3**.

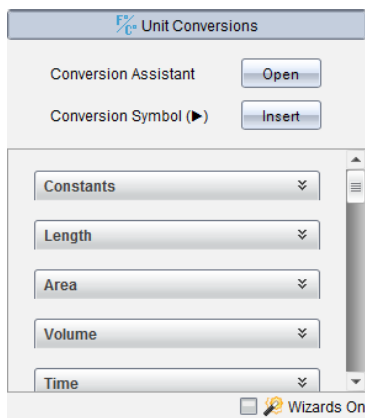

- Click the **Length** category to expand the list of pre-defined length units.

Handheld: Scroll to the **Length** category, and press **Enter**.

- Scroll to **meter**.

Handheld: Scroll to **\_m** (noting the **meter** hint in the Help window).

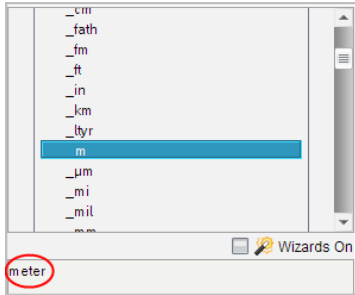

- Press **Enter** to paste **\_m** to the entry line.

12\_m

- Click the Conversion Operator (**▶**) at the top of the Units list, and press **Enter** to paste it to the entry line.

12\_m▶

- Select **\_ft** from the Length category, and press **Enter**.

12\_m▶\_ft

- Press **Enter** to evaluate the expression.

12·\_m▶\_ft 39.3701·\_ft

### CAS: Creating a User-defined Unit

As with the pre-defined units, user-defined unit names must begin with an underscore symbol.

Example: Using the pre-defined units *\_ft* and *\_min*, define a unit named *\_fpm* that lets you enter velocity values in feet per minute and convert velocity results to feet per minute.

Define  $\_fpm = \frac{\_ft}{\_min}$  Done

Now you can use the new velocity unit  $\text{fpm}$ .

$15 \cdot \text{knot} \blacktriangleright \text{fpm}$	$1519.03 \cdot \text{fpm}$
$160 \cdot \text{mph} \blacktriangleright \text{fpm}$	$14080 \cdot \text{fpm}$
$500 \cdot \text{fpm} \blacktriangleright \text{knot}$	$4.93737 \cdot \text{knot}$

## Using the Unit Conversion Assistant

In any application where math input is allowed, you can generate unit conversions using the Unit Conversion Assistant. This can help reduce syntax errors by automatically entering the units for you.

Example: Convert 528 minutes to hours. The desired expression is  $528 \cdot \text{min} \blacktriangleright \text{hr}$ .

1. Type **528** on the entry line.
2. On the **Utilities** tab, click the **Unit Conversions** bar.

Handheld: Press  **3**.

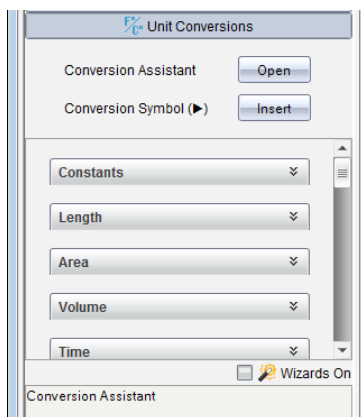

3. Click the **Open** button next to **Conversion Assistant**.

Handheld: Press .

The **Unit Conversion Assistant** dialog box displays:

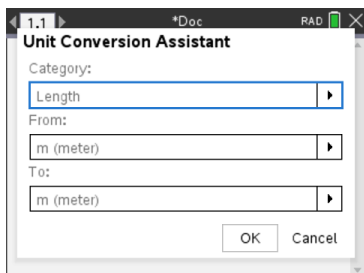

4. Click the **Category** list and select **Time**.

Handheld: Scroll to the **Time** category and press **enter**.

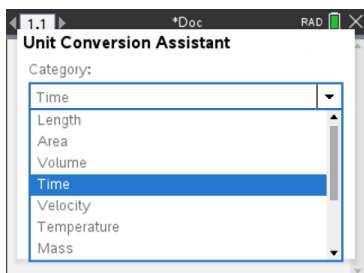

5. Click the **From** list and select **min (minute)**.

Handheld: Scroll to **min (minute)** and press **enter**.

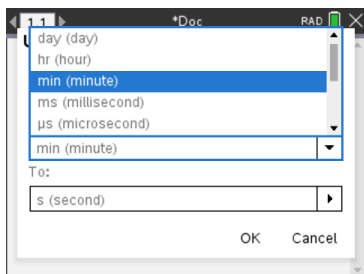

**Note:** You can select **Use existing unit** at the bottom of the list if you have already entered a unit. In this example, you might have already entered 528\*\_min.

6. Click the **To** list and select **hr (hour)**.

Handheld: Scroll to **hr (hour)** and press **enter**.



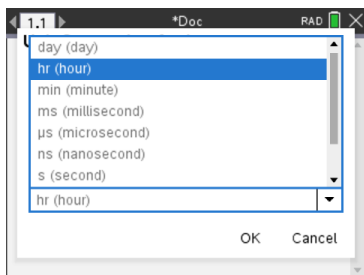

7. Click **OK** to paste `_min ► _hr` to the entry line.
8. Press **Enter** to evaluate the expression.

Handheld: Press `enter`.

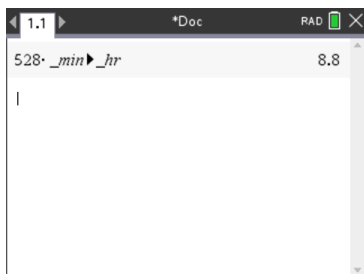

**Note:**

- The last Category, From, and To selections will be retained until:
  - the software is closed and re-opened (Desktop)
  - the device is reset (Handheld)
  - the language is changed, or the app is uninstalled or upgraded (iPad)
- Inserting a conversion into a Notes text field will automatically create a Math Box.
- Inserting a conversion into an empty line in the Calculator will automatically insert **Ans** before the conversion.

### ***Working with Variables***

When you first store a value in a variable, you give the variable a name.

- If the variable does not already exist, Calculator creates it.
- If the variable already exists, Calculator updates it.

Variables within a problem are shared by TI-Nspire™ applications. For example, you can create a variable in Calculator and then use or modify it in Graphs & Geometry or Lists & Spreadsheet within the same problem.

For more information, see *Using Variables*.

## Creating User-defined Functions and Programs

You can use the **Define** command to create your own functions and programs. You can create them in the Calculator application or in the Program Editor and then use them in other TI-Nspire™ applications.

For more information, see *Overview of the Program Editor and Libraries*.

### Defining a Single-line Function

Suppose you want to define a function named **cube()** that calculates the cube of a number or variable.

1. On the Calculator entry line, type **Define cube(x)=x^3** and press **Enter**.

Define  $cube(x)=x^3$  Done

The message “Done” confirms that the function has been defined.

2. Type **cube(2)** and press **Enter** to test the function.

$cube(2)$  8

### Defining a Multiple-line Function Using Templates

You can define a function consisting of multiple statements entered on separate lines. A multiple-line function may be easier to read than one with multiple statements separated by colons.

**Note:** You can create multiple-line functions only by using the **Define** command. You cannot use the  $:=$  or  $\rightarrow$  operators to create multiple-line definitions. The **Func...EndFunc** template serves as a container for the statements.

As an example, define a function named **g(x,y)** that compares two arguments  $x$  and  $y$ . If argument  $x >$  argument  $y$ , the function should return the value of  $x$ . Otherwise, it should return the value of  $y$ .

1. On the Calculator entry line, type **Define g(x,y)=**. Do not press **Enter** yet.

define  $g(x,y)=$

2. Insert the **Func...EndFunc** template.

From the **Functions & Programs** menu, select **Func...EndFunc**.

Calculator inserts the template.

---

```
define g(x,y)=Func
  |
  EndFunc
```

---

3. Insert the **If...Then...Else...EndIf** template.

From the **Functions & Programs** menu, select **Control**, and then select **If...Then...Else...EndIf**.

Calculator inserts the template.

---

```
define g(x,y)=Func
  If|Then
  Else
  EndIf
  EndFunc
```

---

4. Type the remaining parts of the function, using the arrow keys to move the cursor from line to line.

---

```
define g(x,y)=Func
  If x>y Then
    return x
  Else
    return y|
  EndIf
  EndFunc
```

---

5. Press **Enter** to complete the definition.
6. Evaluate **g(3, -7)** to test the function.

---

```
g(3,-7) 3
```

---

### Defining a Multiple-line Function Manually

Within a multi-line template such as **Func...EndFunc** or **If...EndIf**, you can start a new line without completing the definition.

- **Handheld:** Press **↵** instead of **enter**.
- **Windows®:** Hold **Alt** and press **Enter**.
- **Macintosh®:** Hold **Option** and press **Enter**.

As an example, define a function **sumIntegers(x)** that calculates the cumulative sum of integers from 1 through  $x$ .

1. On the Calculator entry line, type **Define sumIntegers(x)=**. Do not press **Enter** yet.

---

```
Define sumIntegers(x)=|
```

---

2. Insert the **Func...EndFunc** template.

From the **Functions & Programs** menu, select **Func...EndFunc**.

Calculator inserts the template.

---

```
Define sumIntegers(x)=Func
                        |
                        EndFunc
```

---

3. Type the following lines, pressing  $\boxed{\rightarrow}$  or **Alt+Enter** at the end of each line.

---

```
Define sumIntegers(x)=Func
    Local i,tmpsum
    tmpsum:=0
    For i,1,x
        tmpsum:=tmpsum+i
    EndFor
    Return tmpsum
EndFunc
```

---

4. After typing **Return tmpsum**, press **Enter** to complete the definition.
5. Evaluate **sumIntegers(5)** to test the function.

---

```
sumIntegers(5) 15
```

---

## Defining a Program

Defining a program is similar to defining a multiple-line function. The **Prgm...EndPrgm** template serves as a container for the program statements.

As an example, create a program named **g(x,y)** that compares two arguments. Based on the comparison, the program should show the text " $x>y$ " or " $x\leq y$ " (showing the values of  $x$  and  $y$  in the text).

1. On the Calculator entry line, type **Define prog1(x,y)=**. Do not press **Enter** yet.

---

```
Define prog1(x,y)=|
```

---

2. Insert the **Prgm...EndPrgm** template.

From the **Functions & Programs** menu, select **Prgm...EndPrgm**.

---

```
Define prog1(x,y)=Prgm
  |
  EndPrgm
```

---

3. Insert the **If...Then...Else...EndIf** template.

From the **Functions & Programs** menu, select **Control**, and then select **If...Then...Else...EndIf**.

---

```
Define prog1(x,y)=Prgm
  If | Then
  Else
  EndIf
  EndPrgm
```

---

4. Type the remaining parts of the function, using the arrow keys to move the cursor from line to line. Use the Symbol Palette to select the " $\leq$ " symbol.

---

```
Define prog1(x,y)=Prgm
  If x>y Then
    Disp x, "> ",y
  Else
    Disp x, " $\leq$  ",y
  EndIf
  EndPrgm
```

---

5. Press **Enter** to complete the definition.
6. Execute **prog1(3,-7)** to test the program.

---

```
prog1(3,-7)
3 > -7
Done
```

---

### Recalling a Function or Program Definition

You might want to reuse or modify a function or program that you have defined.

1. Show the list of defined functions.

From the **Actions** menu, select **Recall Definition**.

2. Select the name from the list.

The definition (for example, **Define f(x)=1/x+3**) is pasted into the entry line for editing.

## Editing Calculator Expressions

Although you cannot edit an expression in the Calculator history, you can copy all or part of an expression from the history and paste it to the entry line. You can then edit the entry line.

### Positioning the Cursor in an Expression

- ▶ Press **Tab**, **◀**, **▶**, **▲**, or **▼** to move the cursor through the expression. The cursor moves to the closest valid position in the direction that you press.

**Note:** An expression template may force the cursor to move through its parameters, even though some parameters may not be exactly in the path of the cursor movement. For example, moving upward from the main argument of an integral always moves the cursor to the top limit.

### Inserting into an Expression in the Entry Line

1. Position the cursor at the point where you want to insert additional elements.
2. Type the elements that you want to insert.

**Note:** When you insert an open parenthesis, Calculator adds a temporary close parenthesis, displayed in gray. You can override the temporary parenthesis by typing the same parenthesis manually or by entering something past the temporary parenthesis (thereby implicitly validating its position in the expression). After you override the temporary gray parenthesis, it is replaced with a black parenthesis.

### Selecting Part of an Expression

1. Position the cursor at the starting point in the expression.  
Handheld: Press **◀**, **▶**, **▲**, or **▼** to move the cursor.
2. Press and hold **Shift**, and then press **◀**, **▶**, **▲**, or **▼** to select.

### Deleting all or part of an expression on the entry line

1. Select the part of the expression to delete.
2. Press **Del**.

## Financial Calculations

Several TI-Nspire™ functions provide financial calculations, such as time value of money, amortization calculations, and return on investment calculations.

The Calculator application also includes a Finance Solver. It lets you dynamically solve several types of problems, such as loans and investments.

## Using the Finance Solver

1. Open the Finance Solver.

From the **Finance** menu, click **Finance Solver**.

The Finance Solver displays its default values (or previous values, if you have already used the solver in the current problem).

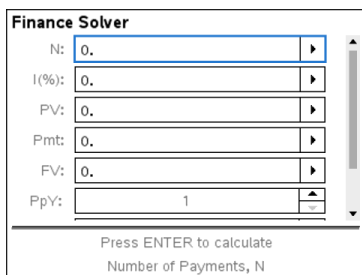

The screenshot shows the Finance Solver interface with the following values:

N:	0.
I(%):	0.
PV:	0.
Pmt:	0.
FV:	0.
PpY:	1

Press ENTER to calculate  
Number of Payments, N

2. Enter each known value, using **Tab** to cycle through the items.
  - The help information at the bottom of the Finance Solver describes each item.
  - You might need to temporarily skip the value that you want to calculate.
  - Make sure to set **PpY**, **CpY**, and **PmtAt** to the correct settings (12, 12, and END in this example).
3. Press **Tab** as necessary to select the item that you want to calculate, and then press **Enter**.

The Finance Solver calculates the value and stores all the values in “tvm.” variables, such as *tvm.n* and *tvm.pmt*. These variables are accessible to all TI-Nspire™ applications within the same problem.

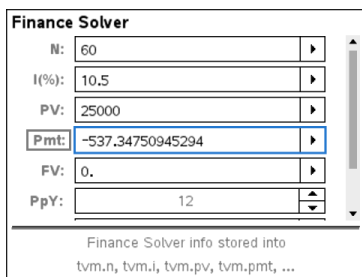

The screenshot shows the Finance Solver interface with the following values:

N:	60
I(%):	10.5
PV:	25000
Pmt:	-537.34750945294
FV:	0.
PpY:	12

Finance Solver info stored into  
tvm.n, tvm.i, tvm.pv, tvm.pmt, ...

## Finance Functions Included

In addition to the Finance Solver, TI-Nspire™ built-in finance functions include:

- TVM functions for calculating future value, present value, number of payments, interest rate, and payment amount.

- Amortization information such as amortization tables, balance, sum of interest payments, and sum of principal payments.
- Net present value, internal rate of return, and modified rate of return.
- Conversions between nominal and effective interest rates, and calculation of days between dates.

#### Notes:

- Finance functions do not automatically store their argument values or results to the TVM variables.
- For a complete list of TI-Nspire™ functions, see the *Reference Guide*.

### Working with the Calculator History

As you enter and evaluate expressions in the Calculator application, each entry/result pair is saved in the Calculator history. The history gives you a way to review your calculations, repeat a set of calculations, and copy expressions for reuse in other pages or documents.

#### Viewing the Calculator History

**Note:** You may notice a processing slowdown when the history contains a large number of entries.

- ▶ Press  $\blacktriangle$  or  $\blacktriangledown$  to scroll through the history.

$\frac{3.76}{-7.9+\sqrt{5}}$	-0.66385
$-0.66384977522033+2\cdot\log_{10}(45)$	2.64258
$a:=5:b:=2\cdot\frac{a}{b}\cdot 1$	2.5
Define $cube(x)=x^3$	Done

#### Copying a Calculator History Item to the Entry Line

You can quickly copy an expression, subexpression, or result from the history into the entry line.

1. Press  $\blacktriangle$  or  $\blacktriangledown$  to move through the history and select the item that you want to copy.

—or—

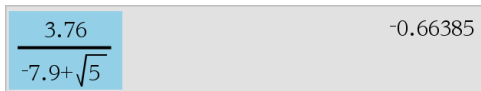

Select part of the expression or result by using **Shift** in combination with the arrow keys.

$$\frac{3.76}{-7.9+\sqrt{5}} \quad -0.66385$$

**Note:** The float setting for the current document may limit the number of decimal places displayed in a result. To capture the result in its full precision, select it either by scrolling with the up and down arrow keys or by triple-clicking it.

2. Press **Enter** to copy the selection and insert it into the entry line.

$$\frac{3.76}{-7.9+\sqrt{5}}$$

### Copying a History Item to Another Application

1. Press **▲** or **▼** to move through the history and select the item that you want to copy.
2. Optionally, select part of the expression or result by pressing **Shift** in combination with the arrow keys.
3. Use the standard key shortcut for copying a selection.

Windows®: Press **Ctrl+C**.

Mac®: Press **⌘+C**.

Handheld: Press **ctrl** **C**.

4. Place the cursor at the location where you want the copy.
5. Paste the copy.

Windows®: Press **Ctrl+V**.

Mac®: Press **⌘+V**.

Handheld: Press **ctrl** **V**.

**Note:** If you copy an expression that uses variables into a different problem, the values of those variables are not copied. You must define the variables in the problem where you paste the expression.

## Deleting an Expression from the History

When you delete an expression, all variables and functions defined in the expression retain their current values.

1. Drag or use the arrow keys to select the expression.

Handheld: Use the arrow keys.

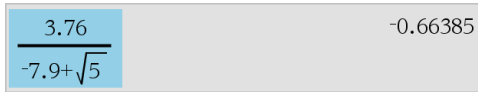

The image shows a calculator display with a light gray background. On the left, a fraction  $\frac{3.76}{-7.9+\sqrt{5}}$  is displayed. The numerator '3.76' is in a light blue box, and the denominator '-7.9+\sqrt{5}' is in a light gray box. On the right, the decimal result '-0.66385' is displayed.

2. Press **Del**.

The expression and its result are removed.

## Clearing the Calculator History

When you clear the history, all variables and functions defined in the history retain their current values. If you clear the history by mistake, use the undo feature.

- From the **Actions** menu, select **Clear History**.

All expressions and results are removed from the history.

## Using Variables

A variable is a defined value that can be used multiple times in a problem. You can define a value or function as a variable within each application. Within a problem, variables are shared by TI-Nspire™ applications. For example, you can create a variable in Calculator, and then use or modify it in Graphs & Geometry or Lists & Spreadsheet within the same problem.

Each variable has a name and a definition and the definition can be changed. When you change the definition, all occurrences of the variable in the problem are updated to use the new definition. In the TI-Nspire™ software, a variable has four attributes:

- Name - User-defined name assigned when the variable is created.
- Location - Variables are stored in memory.
- Value - Number, text, mathematical expression, or function.
- Type - Type of data that can be stored as a variable.

**Note:** Variables created with the **Local** command within a user-defined function or program are not accessible outside that function or program.

### *Linking Values on Pages*

Values and functions created or defined in one application can interact with other applications (within the same problem) to share data.

When using linked items, keep in mind:

- Values can be linked between applications on one page or between different pages of the same problem.
- All applications are linked to the same data.
- If the linked value is changed in the original application, the change is reflected in all linked usages.

Defining a variable is the first step in linking values.



### *Creating Variables*

Any portion or attribute of an object or function created within an application can be stored as a variable. Examples of attributes that can become variables are the area of a rectangle, the radius of a circle, the value contained in a spreadsheet cell or the contents of a row or column, or a function expression. When you create a variable, it is stored in memory.

#### **Types of Variables**

You can store the following data types as variables:

Data type	Examples
Expression $0_{1z}$	$2.54$ $1.25E6$ $2\pi$ $x_{\min}/10$ $2+3i$ $(x-2)^2$ $\frac{\sqrt{2}}{2}$
List {...}	{2, 4, 6, 8} {1, 1, 2} {"red", "blue", "green"}
Matrix $0_{2z}$	$\begin{bmatrix} 1 & 2 & 3 \\ 3 & 6 & 9 \end{bmatrix}$ This can be entered as: $[1, 2, 3; 3, 6, 9]$
Character string ...	"Hello" "xmin/10" "The answer is:"
Function, program $f(x)$	myfunc( arg ) ellipse( x, y, r1, r2 )
Measurement $0_{1z}$	area, perimeter, length, slope, angle

When you click  or press  on a handheld to open the list of stored variables, a symbol indicates the type.

### Creating a Variable from a Calculator Value



This example shows how to create a variable using a handheld. Complete the following steps to create a variable named *num* and store the result of the expression  $5+8^3$  in that variable.

1. On the Calculator entry line, type the expression  $5+8^3$ .

5+8<sup>3</sup>

2. Press  to expand the cursor to the baseline.

5+8<sup>3</sup>

3. Press   and then type the variable name **num**.

---

$$5+8^3 \rightarrow \mathbf{num}$$

This means: Calculate  $5+8^3$  and store the result as a variable named *num*.

4. Press .

Calculator creates the variable *num* and stores the result there.

---

$$5+8^3 \rightarrow \mathbf{num} \qquad 517$$

---

### Creating a Variable in the Computer Software

When creating a variable in the computer software, use the following conventions. As alternatives to using  $\rightarrow$  (store), you can use “:=” or the **Define** command. All of the following statements are equivalent.

$5+8^3 \rightarrow \mathbf{num}$   
 $\mathbf{num} := 5+8^3$   
Define  $\mathbf{num}=5+8^3$

### Checking a Variable's Value

You can check the value of an existing variable by entering its name on the Calculator entry line. When you type the name of a stored variable, it appears in bold type.

- On the Calculator entry line, type the variable name **num** and press .

The value most recently stored in *num* is displayed as the result.

---

num	517
-----	-----

---

### Automatically Creating Variables in Graphs & Geometry

In the Graphs and Geometry applications, functions defined on the entry line are automatically stored as variables.



$f1(x)=x^3$  

In this example,  $f1(x)=x^3$  is a variable definition, which allows it to be displayed in other applications including a table in the Lists & Spreadsheet application.

### Creating a Variable from a Graphs & Geometry Value

1. Click the value to store as a variable.

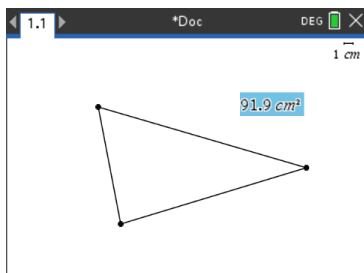

2. Click **Var**.

Handheld: Press **var**.

The Variables options are displayed with **Store Var** highlighted.

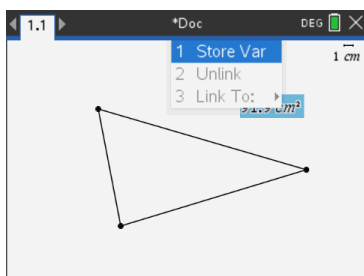

3. Press **enter**. VAR := appears before the selected value. This is the default name.

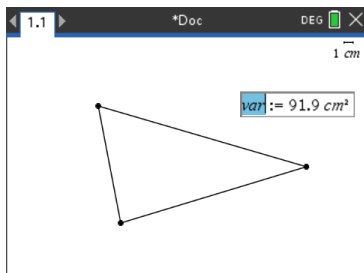

4. Replace the default name VAR with the variable name you want to give the value.

5. When the variable name is typed, press **enter**.

The value is saved to that variable name, and the stored value or its name appears in bold text to indicate it is a stored value.

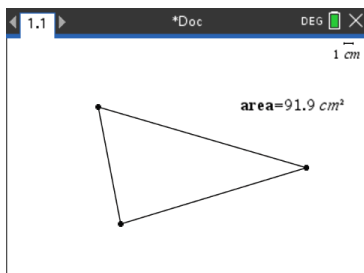

**Note:** You can also share a Graphs & Geometry axis end value with other applications. If necessary, click **Actions**, **Show/Hide Axes End Values** to display the end values on the horizontal and vertical axes. Click the number for an end value to highlight it in the entry field. Name the variable and store it for use with other applications by using any method described in Step 2.

### Automatically Creating Variables in Lists & Spreadsheet

Naming a list at the top of a Lists & Spreadsheet column automatically stores that value as a list variable. This variable can be used in other applications including Data & Statistics.

### Creating a Variable from a Lists & Spreadsheet Cell Value

You can share a cell value with other applications. When defining or referring to a shared cell in Lists & Spreadsheet, precede the name with an apostrophe (').

1. Click the cell that you want to share.
2. Click  to open the Variables menu.

Handheld: Press .

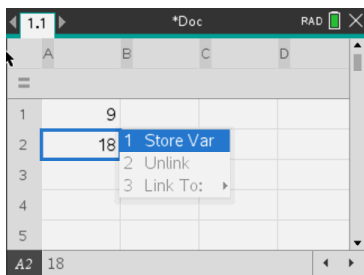

3. Click **Store Var**.

A formula is inserted into the cell with *var* as a placeholder for a variable name.

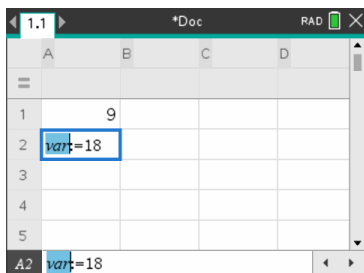

4. Replace the letters “var” with a name for the variable, and press .

The value is now available as a variable to other applications within the same problem.

**Note:** If a variable with the name you specified already exists in the current problem space, Lists & Spreadsheet displays an error message.

### **Using (Linking) Variables**

Sharing, or linking, the variables you create is a powerful tool for math exploration. The display of linked variables is automatically updated when the variable’s value changes.

#### **Linking to Shared Variables**

To use a stored variable:

1. Display the page and select the location or object to which you want to link a variable.
2. Select the Variables tool .

The Variables options are displayed. The software knows which types of variables will work in the location or with the object selected and will only display those variables.

3. Use ▲ and ▼ to scroll the list.

—or—

Type part of the variable name.

As you type, the system displays a list of variables that begin with the letters you typed. Typing part of the name enables you to locate a variable more quickly if the list is long.



- When you locate and highlight the name of the variable you want to use, click the name.

—or—

Press **enter**.

The selected variable value is linked.

### Linking a Lists & Spreadsheet Cell to a Variable

When you link a cell to a variable, Lists & Spreadsheet keeps the cell value updated to reflect the current value of the variable. The variable can be any variable in the current problem and can be defined in Graphs & Geometry, Calculator, or any instance of Lists & Spreadsheet.

**Note:** Do not link to a system variable. Doing so could prevent the variable from being updated by the system. System variables include *ans*, *StatMatrix*, and statistics results (such as *RegEqn*, *dfError*, and *Resid*).

- Click the cell that you want to link to the variable.

- Open the VarLink menu:

- Click **var**, and then click **Cell**.
- Handheld: Press **var**.

The VarLink menu is displayed.

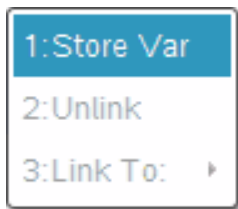

- Under **Link To**, scroll to the name of the variable and click it.

The cell shows the value of the variable.

### Using a Variable in a Calculation

After storing a value in a variable, you can use the variable name in an expression as a substitute for the stored value.

- Enter the expression:

- Type  $4 * 25 * \text{num}^2$  on the entry line, and press **Enter**.
- Handheld: Type  $4$   $\times$   $25$   $\times$   $\text{num}$   $\times^2$  on the entry line, and press **enter**.

Calculator substitutes 517, the value currently assigned to *num*, and evaluates the expression.

---

$$4 \cdot 25 \cdot \text{num}^2 \qquad 26728900$$

---

2. Enter the expression:

- Type  $4 * 25 * \text{nonum}^2$ , and press **Enter**.
- Handheld: Type  $4$   $\times$   $25$   $\times$   $\text{nonum}$   $\times^2$  on the entry line, and press **enter**.

---

$$4 \cdot 25 \cdot \text{nonum}^2 \qquad 100 \cdot \text{nonum}^2$$

---

CAS: Because the variable *nonum* has not been defined, it is treated algebraically in the result.

---

$$4 \cdot 25 \cdot \text{nonum}^2$$

---

"Error: Variable is not defined"

---

Because the variable *nonum* has not been defined, the expression returns an error message.

## Naming Variables

Variable and function names that you create must meet the following naming rules.

**Note:** In the unlikely event that you create a variable with the same name as one used for statistical analysis or by the Finance Solver, an error condition could occur. If you begin entering a variable name that is already in use in the current problem, the software shows the entry in **bold** to let you know.

- Variable names must be in one of the forms *xxx* or *xxx.yyy*. The *xxx* part can have 1 to 16 characters. The *yyy* part, if used, can have 1 to 15 characters. If you use the *xxx.yyy* form, both *xxx* and *yyy* are required; you cannot start or end a variable name with a period ".".
- Characters can consist of letters, digits, and the underscore character (  ). Letters can be U.S. or Greek letters (but not  $\Pi$  or  $\pi$ ), accented letters, and international letters.
- Do not use **c** or **n** from the symbol palette to construct a variable name such as **c1** or **n12**. These may appear to be letters, but they are treated internally as special symbols.

- You can use uppercase or lowercase letters. The names  $AB22$ ,  $Ab22$ ,  $aB22$ , and  $ab22$  all refer to the same variable.
- You cannot use a digit as the first character of  $xxx$  or  $yyy$ .
- You can use digits 0 through 9, U.S. letters, a - z, Latin and Greek letters (but not  $\pi$ ) as subscripts (for example,  $a_2$ ,  $q_a$ , or  $h_2o$ ). To enter a subscript while typing a variable name, select  $\square$  in the Math Templates or on the formatting toolbar.
- Do not use spaces.
- If you want a variable to be treated as a complex number, use an underscore as the last character of the name.
- CAS: If you want a variable to be treated as a type of unit (such as  $_m$  or  $_ft$ ), use an underscore as the first character of the name. You cannot use subsequent underscores in the name.
- You cannot use an underscore as the first character of the name.
- You cannot use a preassigned variable, function, or command name, such as **Ans**, **min**, or **tan**.

**Note:** For more information about TI-Nspire™ functions, see the *Reference Guide*.

- Library documents and library objects are subject to additional naming restrictions. For more information, see *Libraries*.

Here are some examples:

Variable names	Valid?
$Myvar$ , $my.var$	Yes
$My var$ , $list 1$	No. Contains a space.
$a$ , $b$ , $b12$ , $b_{12}$ , $c$ , $d$	Yes. Note that variables $b12$ and $b_{12}$ are distinct.
$Log$ , $Ans$	No. Preassigned to a system function or variable.
$Log1$ , $list1.a$ , $list1.b$	Yes
$3rdTotal$ , $list1.1$	No. $xxx$ or $yyy$ starts with a digit.

## Adjusting Variable Values with a Slider

A slider control lets you interactively adjust or animate the value of a numeric variable. You can insert sliders in the Graphs, Geometry, Notes, and Data & Statistics applications.

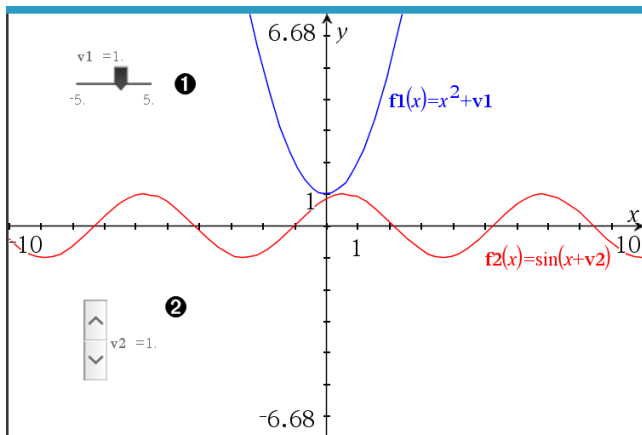

- ❶ Horizontal slider for adjusting variable  $v1$ .
- ❷ Minimized vertical slider for adjusting variable  $v2$ .

**Note:** TI-Nspire™ version 4.2 or higher is required for opening .tns files containing sliders on Notes pages.

### Inserting a Slider Manually

1. From a Graphs, Geometry, or Data & Statistics page, select **Actions > Insert Slider**.  
—Or—  
From a Notes page, make sure the cursor is not in a math box or chem box, and then select **Insert > Insert Slider**.

The Slider Settings screen opens.

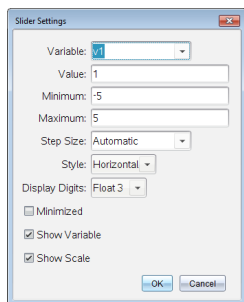

2. Enter the desired values, and click **OK**.

The slider is displayed. On a Graphs, Geometry, or Data & Statistics page, handles are displayed to let you move or stretch the slider.

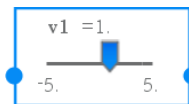

To remove the handles and use the slider, click an empty space in the work area. You can show the handles anytime by selecting **Move** from the slider's context menu.

3. To adjust the variable, slide the pointer (or click the arrows on a minimized slider).
  - You can use the **Tab** key to move the focus to a slider or to move from one slider to the next. The color of the slider changes to show you when it has the focus.
  - When a slider has the focus, you can use the arrow keys to change the value of the variable.

### Working with the Slider

Use the options on the context menu to move or delete the slider, and to start or stop its animation. You can also change the slider's settings.

1. Display the slider's context menu.

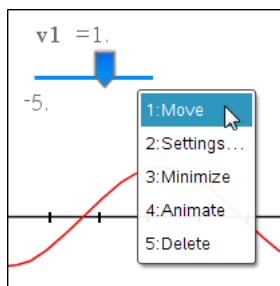

2. Click an option to select it.

### Automatic Sliders in Graphs

Sliders can be created for you automatically in the Graphs application and in the analytic window of the Geometry application. You are offered automatic sliders when you define certain functions, equations, or sequences that refer to undefined variables.

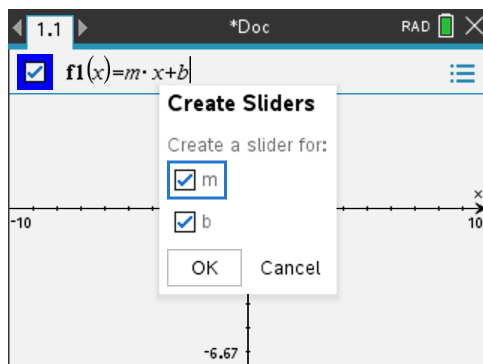

## Locking and Unlocking Variables

Locking lets you protect variables from modification or deletion. Locking prevents unintended changes to a variable.

	A time	B altitude
1	seconds	meters
2	10	64
3	20	59
4	70	49
5	90	44

*Time and altitude lists can be locked to ensure problem fidelity.*

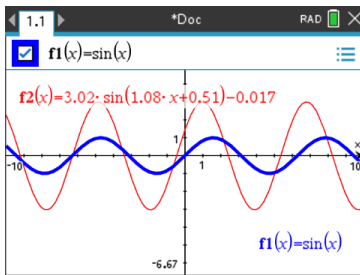

*Reference function **f1** can be locked to prevent unintended change.*

### Variables you Cannot Lock

- System variable *Ans*
- *stat.* and *tvm.* variable groups

### Important Information About Locked Variables

- To lock variables, use the Lock command.
- To modify or delete a locked variable, you must first unlock the item.
- Locked variables display a lock icon on the variable menu list.
- The Lock command clears the Redo/Undo history when applied to unlocked variables.

### Examples of Locking

<b>Lock a, b, c</b>	Locks variables <i>a</i> , <i>b</i> , and <i>c</i> from the Calculator application.
<b>Lock mystats.</b>	Locks all members of variable group <i>mystats</i> .
<b>UnLock func2</b>	Unlocks variable <i>func2</i> .
<b>lm:=getLockInf (var2)</b>	Retrieves the current lock status of <i>var2</i> and assigns that value to <i>lm</i> in the Calculator application.

For more information, see the *Reference Guide*.

## Updating a Variable

If you want to update a variable with the result of a calculation, you must store the result explicitly.

Entry	Result	Comment
$a := 2$	2	
$a^3$	8	Result not stored in variable $a$ .
$a$	2	
$a := a^3$	8	Variable $a$ updated with result.
$a$	8	
$a^2 \rightarrow a$	64	Variable $a$ updated with result.
$a$	64	

## Reusing the Last Answer

Each instance of Calculator automatically stores the last calculated result as a variable named Ans. You can use Ans to create a chain of calculations.

**Note:** Do not link to Ans or any system variable. Doing so could prevent the variable from being updated by the system. System variables include statistics results (such as *Stat.RegEqn*, *Stat.dfError*, and *Stat.Resid*) and Finance Solver variables (such as *tvm.n*, *tvm.pmt*, and *tvm.fv*).

### Example 1

As an example of using Ans, calculate the area of a garden plot that is 1.7 meters by 4.2 meters. Then use the area to calculate the yield per square meter if the plot produces a total of 147 tomatoes.

1. Calculate the area:

- On the Calculator entry line, type  $1.7 * 4.2$ , and press **Enter**.
- Handheld: On the Calculator entry line, type  $1.7$   $\times$   $4.2$ , and press **enter**.

$$\begin{array}{r} 1.7 \cdot 4.2 \\ \hline 7.14 \end{array}$$

2. Reuse the last answer to calculate the yield per square meter:

- Type  $147 / \text{ans}$  and press **Enter** to find the yield.
- Handheld: Type  $147$   $\div$  **ans**, and press **enter** to find the yield.

147	20.5882
7.14	

### Example 2

$$\frac{3.76}{-7.9 + \sqrt{5}}$$

As a second example, calculate  $3.76 / (-7.9 + \sqrt{5})$  and then add  $2 \cdot \log(45)$ .

1. Type  $3.76 / (-7.9 + \text{sqrt}(5))$ , and press **Enter**.

Handheld: Type  $3.76 \div ((-)\text{7.9} + \text{sqrt}(5))$ , and press **enter**.

3.76	-0.66385
$-7.9 + \sqrt{5}$	

2. Type  $\text{ans} + 2 \cdot \log(45)$ , and press **Enter**.

Handheld: Type  $\text{ans} + 2 \times \log(45)$ , and press **enter**.

$-0.66384977522033 + 2 \cdot \log_{10}(45)$	2.64258
---	---------

### Temporarily Substituting a Value for a Variable

Use the “|” (such that) operator to assign a value to a variable for just a single execution of the expression.

$a := 200.12$	200.12
$a^2   a = 100$	10000
$a$	200.12

### Removing a Linked Variable

1. Select the linked variable.
2. Press **var**.

The Variables options are displayed.

3. Select **Unlink**.

The link is removed from the value, and the value is displayed without any bold formatting.



# Graphs Application



The Graphs application lets you:

- Graph and explore functions and other relations, such as inequalities, parametrics, polars, sequences, differential equation solutions, and conics.
- Animate points on objects or graphs and explore their behavior.
- Link to data created by other applications.

## Adding a Graphs Page

- ▶ To start a new document with a blank Graphs page:

From the main **File** menu, click **New Document**, and then click **Add Graphs**.

Handheld: Press  **on**, and select **Graphs** .

- ▶ To add a Graphs page in the current problem of an existing document:

From the toolbar, click **Insert > Graphs**.

Handheld: Press  and select **Insert > Graphs**.

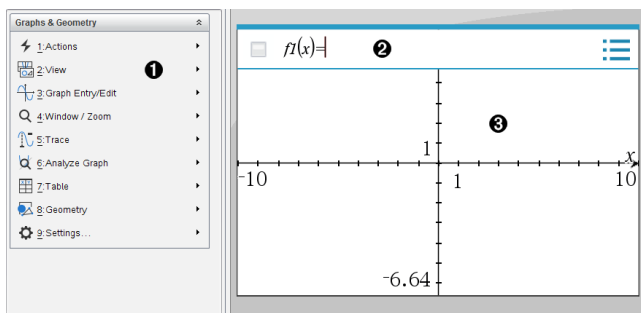

**1 Graphs & Geometry menu.** Contains tools for defining, viewing, and investigating relations.

**2 Entry line.** Lets you define the relations that you want to graph. The default graph type is Function, so the form  $f1(x)=$  is displayed initially. You can define multiple relations for each of several graph types.

**3 Graphs Work Area**

- Shows graphs of relations that you define on the entry line.
- Shows points, lines, and shapes that you create with geometry tools.
- Drag the area to pan (affects only those objects created in the Graphs application).

## What You Must Know

### Changing the Graphs and Geometry Settings

1. From the **Settings** menu in the Documents Toolbox, select **Settings**.
2. Select the settings that you want to use.
  - **Display Digits.** Sets the display format for numbers as Floating or Fixed decimal.
  - **Graphing Angle.** Sets the angle unit for all Graphs and 3D Graphing applications in the current document. The default setting is Radian. Set this to Auto if you want graphing angles to follow the Angle setting in the main **File > Settings** menu. An angle mode indicator shows the resulting mode in Graphs and 3D Graphing applications.
  - **Geometry Angle.** Sets the angle unit for all Geometry applications in the current document. The default setting is Degree. Set this to Auto if you want geometry angles to follow the Angle setting in the main **File > Settings** menu. An angle mode indicator shows the resulting mode in Geometry applications.
  - **Grid.** Sets the grid display in the Graphs application. The default setting is No Grid. Dot Grid and Lined Grid are also available.
  - **Automatically hide plot labels.** In the Graphs application, hides the label that normally appears next to a graphed relation.
  - **Show axis end values.** Applies only in the Graphs application.
  - **Show tool tips for function manipulation.** Applies only in the Graphs application.
  - **Automatically find points of interest.** In the Graphs application, shows zeros, minima, and maxima while tracing function graphs.
  - **Force Geometric Triangle Angles to Integers.** Restricts the angles of a triangle to integer values as you create or edit the triangle. This setting applies only in the Geometry View with the Geometry Angle unit set to Degree or Gradian. It does not apply to analytic triangles in Graphing View or to analytic triangles in the Analytic Window of the Geometry View. This setting does not affect existing angles, and it does not apply when constructing a triangle based on previously inserted points. By default, this setting is deselected.
  - **Automatically Label Points.** Applies labels ( $A, B, \dots, Z, A_1, B_1$ , and so on) to points, lines, and vertices of geometric shapes as you draw them. The labeling sequence starts at  $A$  for each page in a document. By default, this setting is deselected.

**Note:** If you create a new object that uses existing unlabeled points, those point are not automatically labeled in the completed object.

- Click **Restore** to restore all settings to their factory defaults.
- Click **Make Default** to apply the current settings to the open document and save them as the default for new Graphs and Geometry documents.

### Using Context Menus

Context menus provide quick access to commonly used commands and tools that apply to a specific object. For example, you can use a context menu to change an object's line color or to group a set of selected objects.

- ▶ Display the context menu for an object in one of the following ways.
  - Windows®: Right-click the object.
  - Mac®: Hold **⌘** and click the object.
  - Handheld: Move the pointer to the object, and then press **ctrl** **menu**.

### Finding Hidden Objects in the Graphs or Geometry Application

You can hide and show individual graphs, geometric objects, text, labels, measurements, and axis end-values.

To temporarily view hidden graphs or objects or to restore them as shown objects:

1. From the **Actions** menu, select **Hide/Show**.

The Hide/Show tool  appears in the work area, and all hidden objects become visible in dimmed colors.

2. Click a graph or object to toggle its Hide/Show state.
3. To apply the changes and close the Hide/Show tool, press **ESC**.

### Inserting a Background Image

You can insert an image as a background for a Graphs or Geometry page. The file format of the image can be .bmp, .jpg, or .png.

1. From the **Insert** menu, click **Image**.
2. Navigate to the image you want to insert, select it, and then click **Open**.

For information on moving, resizing, and deleting a background image, see [Working with Images in the Software](#).

## Adding Text to the Graphs or Geometry Work Area

1. From the **Actions** menu, select **Text**.

The Text tool  appears in the work area.

2. Click the location for the text.
3. Type the text in the box that appears, and then press **Enter**.

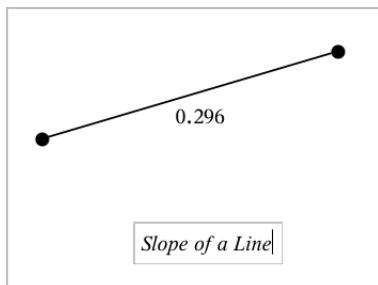

4. To close the Text tool, press **ESC**.
5. To edit the text, double-click it.

## Deleting a Relation and its Graph

1. Select the relation by clicking its graph.
2. Press **Backspace** or **DEL**.

The graph is removed from both the work area and the graph history.

## Graphing Functions

1. From the **Graph Entry/Edit** menu, select **Function**.

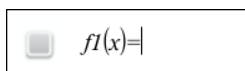

$f1(x)=|$

2. Type an expression for the function.

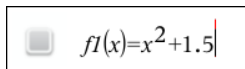

$f1(x)=x^2+1.5|$

3. Press **Enter** to graph the function.

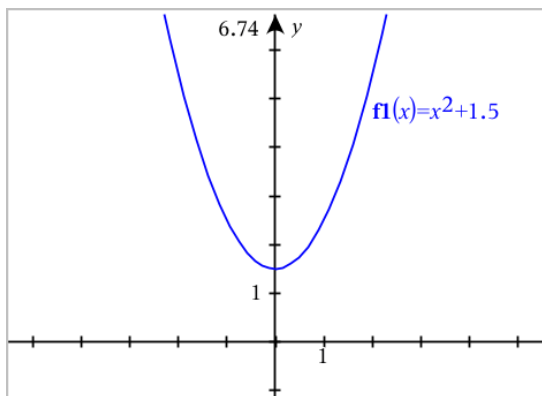

**Note:** For information about path plots, see [Exploring Graphs with Path Plot](#).

## Exploring Graphs with Path Plot

Path Plot lets you animate function, parametric, and polar equation plots in real time to analyze how they are plotted and not just the final plot.

### Changing the Path Plot Settings

1. From the **Trace** menu, select **Path Plot > Path Setup**.

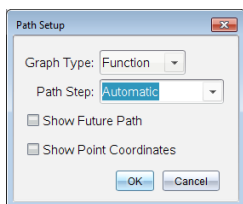

2. Select the settings you want to use.
  - **Graph Type:** Selects Function, Parametric, or Polar as the graph type.
  - **Path Step:** Sets the increment of the independent variable at which values are plotted.
  - **Show Future Path:** Toggles the display of all future points for each function past the starting or current point of the graph. You can also toggle this when viewing the graph with the Up/Down arrow keys.
  - **Show Point Coordinates:** Toggles the display of the coordinates for recorded trace points.

### Enabling Path Plot

1. Enter your equation(s).
2. From the **Trace** menu, select **Path Plot > Function/Parametric/Polar**.
3. Navigate through the animation by:

- using the Play/Pause/Reset Animation icons
- using the Left/Right arrow keys
- entering a number to jump to that point

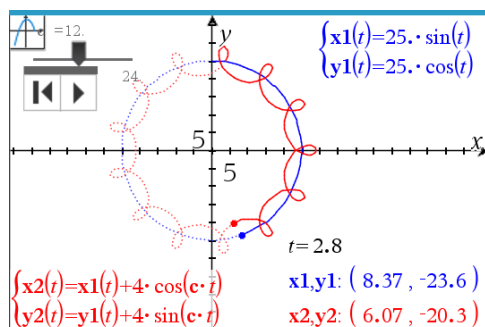

4. Press the Esc key to exit the animation.

### **Manipulating Functions by Dragging**

Some types of functions can be translated, stretched, and/or rotated by dragging parts of the graph. As you drag, the expression for the graph updates to reflect the change.

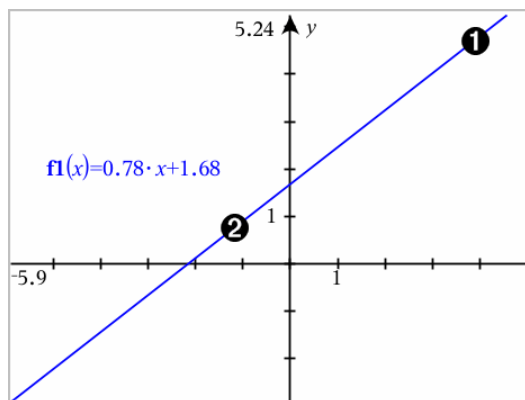

- 1 Drag graph from the ends to rotate.
- 2 Drag graph near the middle to translate.

### **Manipulating a Linear Function**

- To translate, grab near the middle of the graph, and then drag.

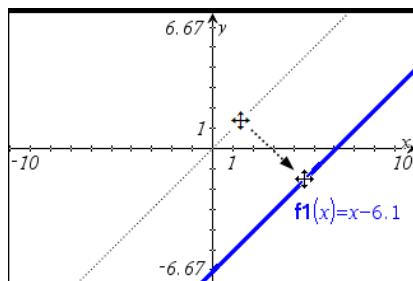

- ▶ To rotate, grab near the ends of the graph, and then drag.

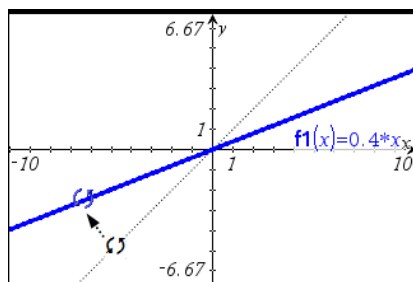

### Manipulating a Quadratic Function

- ▶ To translate, grab near the vertex of the graph, and then drag.

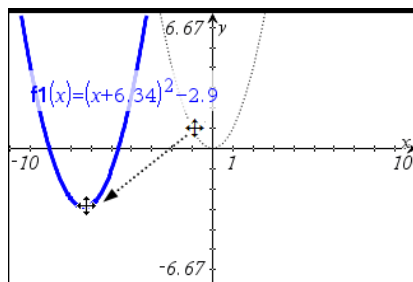

- ▶ To stretch, grab away from the vertex of the graph, and then drag.

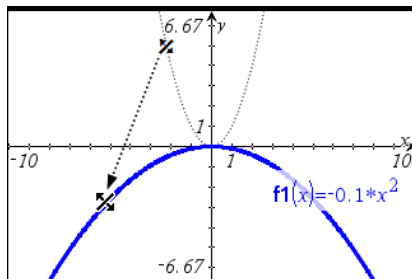

### Manipulating a Sine or Cosine Function

- ▶ To translate, grab near the axis of vertical symmetry of the graph, and then drag.

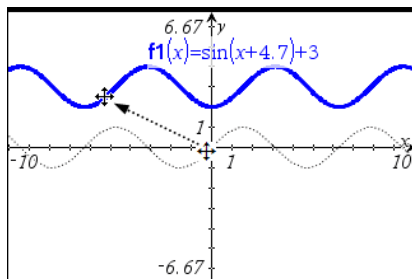

- ▶ To stretch, grab away from the axis of vertical symmetry of the graph, and then drag.

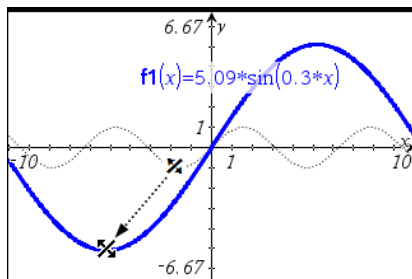

### Specifying a Function with Domain Restrictions

You can use the entry line or the Calculator application to specify a function with domain restrictions. For multiple domain restrictions on a function, use the **piecewise()** function.

In the following example, a function with a domain that is less than 2 and greater than -2 is specified on the entry line:

1. From the **Graph Entry/Edit** menu, select **Function**.



2. Type the following on the entry line, using spaces to separate the "and" operator:

`piecewise(3,x>-2 and x<2)`

3. Tap **Enter** to graph the function.

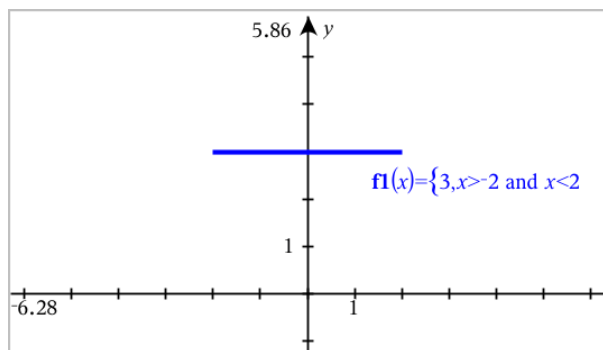

### ***Finding Points of Interest on a Function Graph***

The Graphs application helps you find zeros, minimums, maximums, intersections, derivatives ( $dy/dx$ ), or integrals. For Graphs defined as conic sections, you can also find foci, directrix, and other points.

**(CAS):** You can also find the point of inflection.

### **Identifying Points of Interest by Dragging a Point**

- ▶ To quickly identify maximums, minimums, and zeros, create a point on the graph and then drag the point.

Temporary signposts appear as you drag through points of interest.

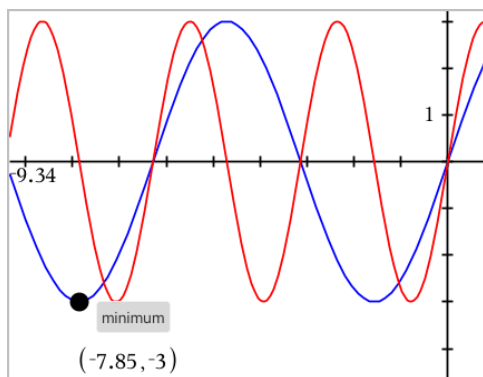

## Identifying Points of Interest with Analysis Tools

This example illustrates using the Minimum tool. Other analysis tools operate similarly.

1. From the **Analyze Graph** menu, select **Minimum**.

The Minimum icon is displayed at the top left on the work area, and a **graph?** prompt appears in the work area.

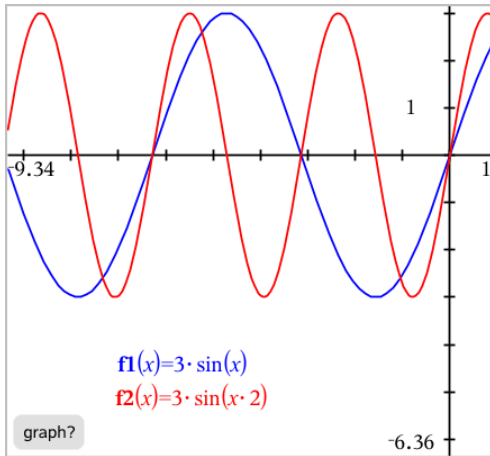

2. Click the graph on which you want to find the minimum.

A dotted line appears, representing the lower bound of the range to search.

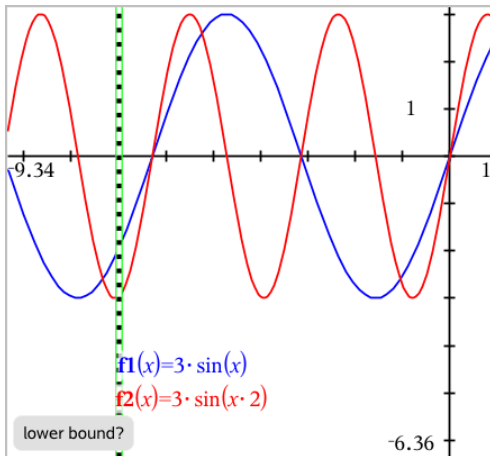

3. Drag the line or click a location to set the lower bound and display a proposed upper bound.

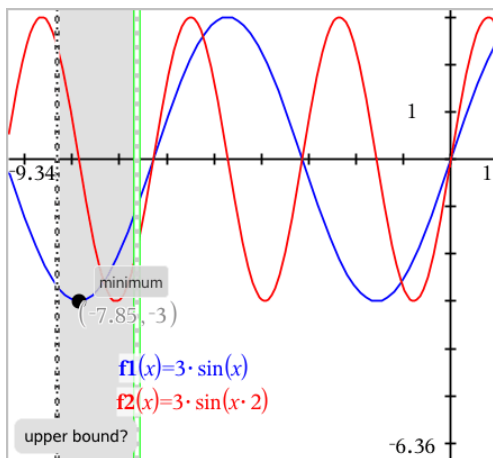

4. Drag the line representing the upper bound, or click a location to set it.  
 The minimum is displayed, along with a text object showing its coordinates.

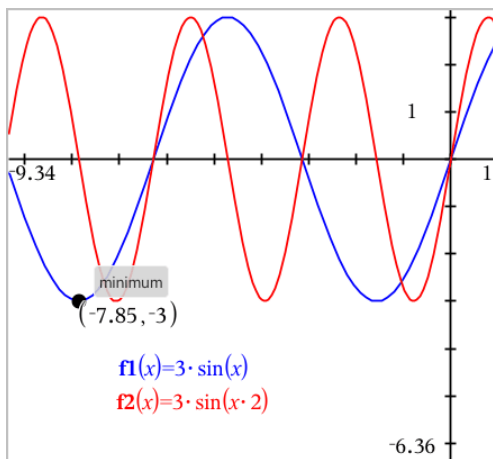

### Graphing a Family of Functions

In a family of functions, each member has its own value for one or more of the parameters. By entering the parameters as lists, you can use a single expression to graph a family of up to 16 functions.

For example, the expression  $f_1(x) = \{-1, 0, 1, 2\} \cdot x + \{2, 4, 6, 8\}$  denotes the following four functions:

$$f1\_1(x) = -1 \cdot x + 2$$

$$f1\_2(x) = 0 \cdot x + 4$$

$$f1\_3(x) = 1 \cdot x + 6$$

$$f1\_4(x) = 2 \cdot x + 8$$

### To Graph a Family of Functions

1. From the **Graph Entry/Edit** menu, select **Function**.
2. Type the expression, using lists to represent the members of the family.

$$f1(x) = \{-1, 0, 1, 2\} \cdot x + \{2, 4, 6, 8\}$$

3. Press **Enter** to graph the functions.

Each member is labeled separately ( $f1\_1$ ,  $f1\_2$ , and so on) to indicate its sequence in the expression.

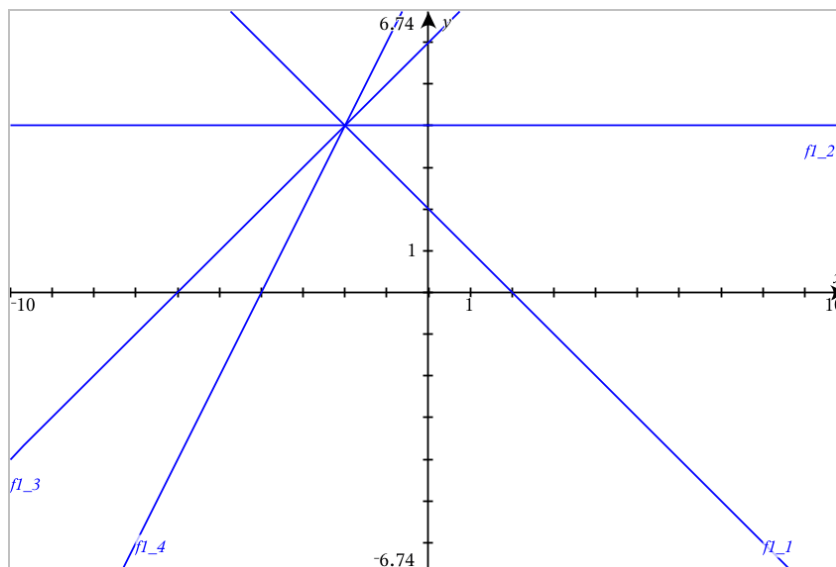

**Note:** You cannot edit a single function graph to change it to a family of functions.

### Graphing Equations

1. From the **Graph Entry/Edit** menu, select **Equation**.
2. Click the type of equation (**Line**, **Parabola**, **Circle**, **Ellipse**, **Hyperbola**, or **Conic**).
3. Click the specific template for the equation. For example, tap  $y = a \cdot x^2 + b \cdot x + c$  to define a parabola.

The entry line includes a symbol to indicate the type of equation.

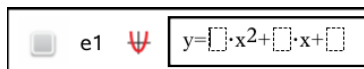

4. Type the coefficients into the equation template.

5. Press **Enter**.

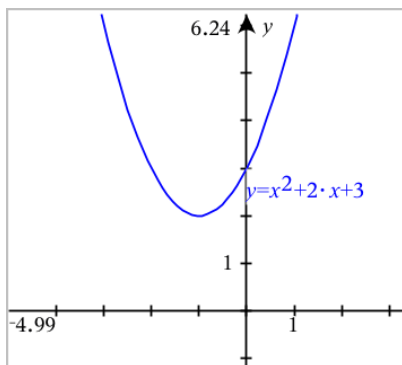

## Graphing Conic Sections

The Graphing view lets you graph and explore linear and conic equations analytically in a two-dimensional coordinate system. You can create and analyze lines, circles, ellipses, parabolas, hyperbolas, and general conic equations.

The entry line makes it easy to enter the equation by displaying a template for the type of equation you choose.

### Example: Creating a conic ellipse

1. From the **Graph Entry/Edit** menu, select **Equation > Ellipse**, and tap the  equation type.

2. Type initial values for the coefficients in the provided spaces. Use the arrow keys to move among the coefficients.

3. Press **Enter** to graph the equation.

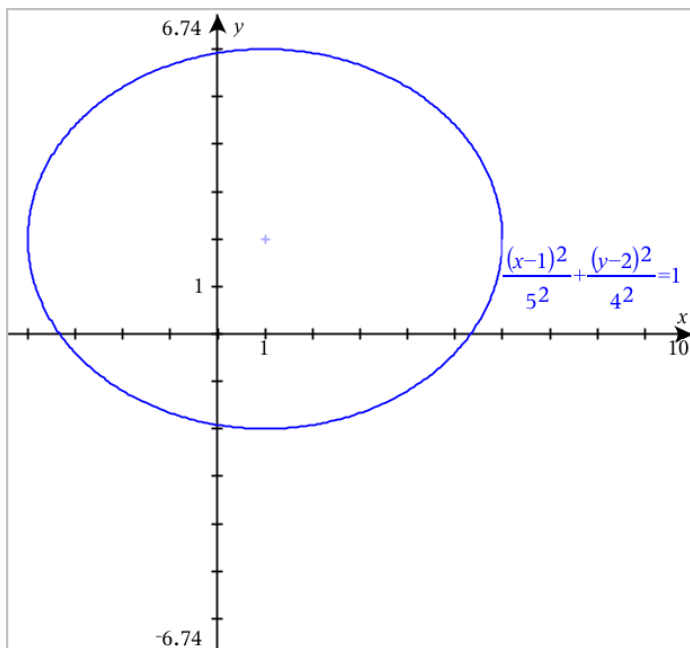

### Exploring the sample ellipse

1. Drag the ellipse from its center to explore the effect of translation on the equation.

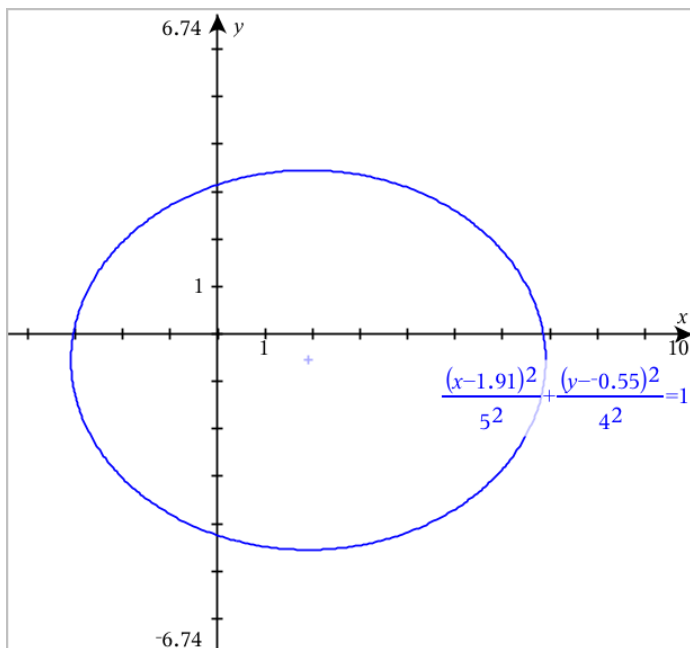

2. Use the analysis tools, such as **Analyze Graph > Analyze Conics > Foci** to further explore the graph.

**Note:** The type of conic determines which analysis tools you can use. In the case of the ellipse, you can obtain its center, vertices, foci, axes of symmetry, directrices, eccentricity, and latera recta.

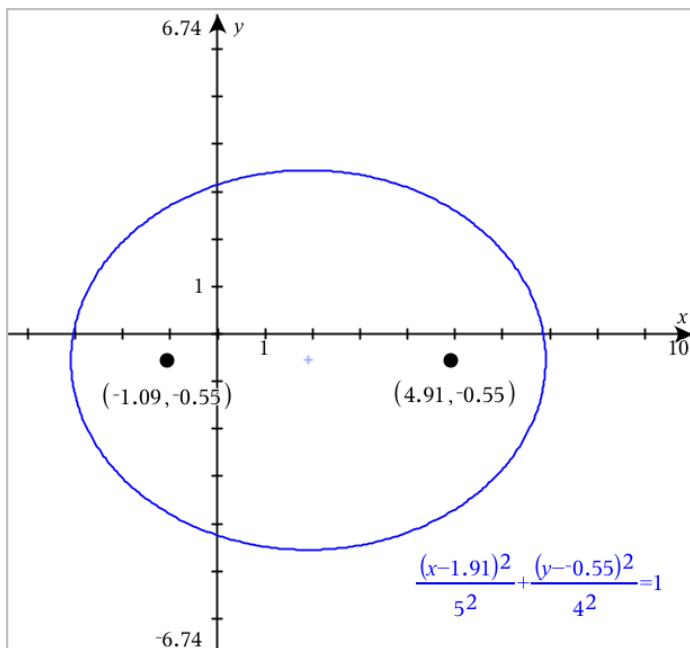

3. To explore translation and dilation interactively, define a conic ellipse that uses variables for the  $h$ ,  $k$ ,  $a$ , and  $b$  coefficients. Insert sliders to vary the parameters.

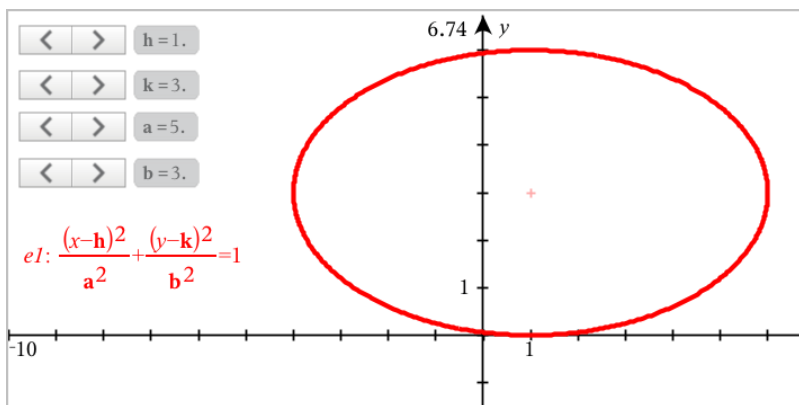

## Graphing Relations

Relation graphing is available on Graphs pages and in the Analytic Window of Geometry pages.



You can define relations using  $\leq$ ,  $<$ ,  $=$ ,  $>$ , or  $\geq$ . The inequality operator ( $\neq$ ) is not supported in relation graphing.

Relation type	Examples
Equations and inequalities equivalent to $y = f(x)$	<ul style="list-style-type: none"> <li><math>y = \sqrt{x}</math></li> <li><math>y - \sqrt{x} = 1/2</math></li> <li><math>-2 * y - \sqrt{x} = 1/2</math></li> <li><math>y - \sqrt{x} \geq 1/2</math></li> <li><math>-2 * y - \sqrt{x} \geq 1/2</math></li> </ul>
Equations and inequalities equivalent to $x = g(y)$	<ul style="list-style-type: none"> <li><math>x = \sin(y)</math></li> <li><math>x - \sin(y) = 1/2</math></li> <li><math>x - \sin(y) \geq 1/2</math></li> </ul>
Polynomial equations and inequalities	<ul style="list-style-type: none"> <li><math>x^2 + y^2 = 5</math></li> <li><math>x^2 - y^2 \geq 1/2 + y</math></li> <li><math>x^3 + y^3 - 6 * x * y = 0</math></li> </ul>
The above relations on domains restricted by rectangles	<ul style="list-style-type: none"> <li><math>y = \sin(x)</math> and <math>-2\pi &lt; x \leq 2\pi</math></li> <li><math>y \leq x^2 \mid y \geq -2</math> and <math>0 \leq x \leq 3</math></li> <li><math>\{x^2 + y^2 \leq 3, y \geq 0</math> and <math>x \leq 0</math></li> </ul>

**Note:** Restrictions imposed by an active Press-to-Test session may limit the types of relations you can graph.

**To Graph a Relation:**

1. From the **Graph Entry/Edit** menu, select **Relation**.



2. Type an expression for the relation.



3. Press **Enter** to graph the relation.

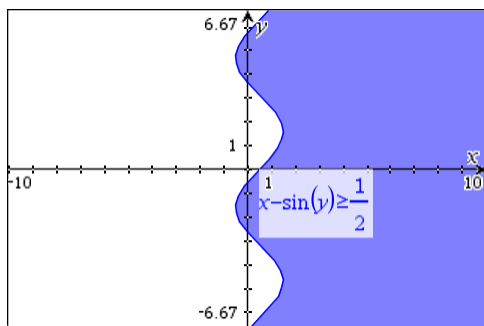

### Tips for Graphing Relations

- ▶ You can quickly define a relation from the Function entry line. Position the cursor to the immediate right of the = sign, and then press the **Backspace** key. A small menu appears with the relation operators and a **Relation** option. Choosing from the menu places the cursor in the Relation entry line.
- ▶ You can type a relation as text on a Graphs page and then drag the text object over either axis. The relation is graphed and added to the relation history.

### Warning and Error Message

Error Condition	Additional Information
Relation input not supported	<p><b>Relation input not supported</b></p> <p><b>Note:</b> The following relation inputs are supported:</p> <ul style="list-style-type: none"> <li>• Relations using <math>\leq</math>, <math>&lt;</math>, <math>=</math>, <math>&gt;</math>, or <math>\geq</math>.</li> <li>• Polynomial relations in <math>x</math> and <math>y</math></li> <li>• Relations equivalent to <math>y=f(x)</math> or <math>x=g(y)</math> or corresponding inequalities</li> <li>• The above relations on domains restricted by rectangles</li> </ul>
Domain Restrictions not supported for certain classes of relations equivalent to $y=f(x)$ or $x=g(y)$ or corresponding inequalities.	<ul style="list-style-type: none"> <li>• Relations equivalent to <math>y=f(x)</math> and corresponding inequalities can only have constraints on <math>x</math></li> <li>• For example: <math>y=\sqrt{x}</math> and <math>0\leq x\leq 1</math> will work but <math>y=\sqrt{x}</math> and <math>0\leq y\leq 1</math> will not</li> <li>• Relations equivalent to <math>x=g(y)</math> and corresponding inequalities can only have constraints on <math>y</math></li> <li>• For example: <math>x=\sin(y)</math> and <math>-1\leq y\leq 1</math> will work but <math>x=\sin(y)</math> and <math>-1\leq x\leq 1</math> will not</li> </ul>

## Graphing Parametric Equations

1. From the **Graph Entry/Edit** menu, select **Parametric**.

Use the up and down arrow keys to move among the fields in the Parametric entry line.

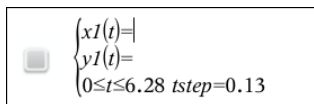
$$\begin{cases} x1(t)=| \\ y1(t)= \\ 0 \leq t \leq 6.28 \quad tstep=0.13 \end{cases}$$

2. Type expressions for  $xn(t)$  and  $yn(t)$ .

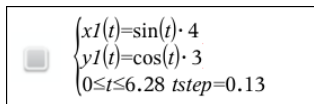
$$\begin{cases} x1(t)=\sin(t) \cdot 4 \\ y1(t)=\cos(t) \cdot 3 \\ 0 \leq t \leq 6.28 \quad tstep=0.13 \end{cases}$$

3. (Optional) Edit the default values for  $tmin$ ,  $tmax$ , and  $tstep$ .
4. Press **Enter**.

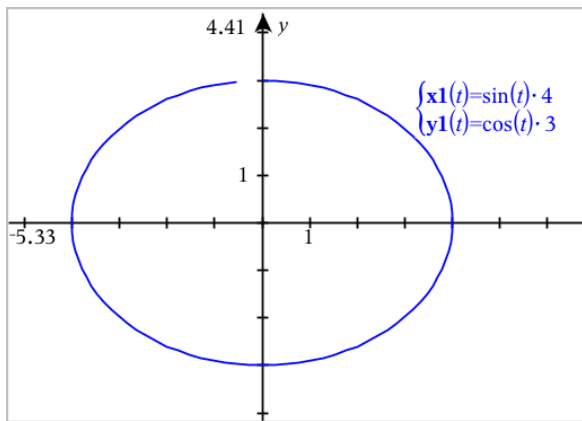

**Note:** For information about path plots, see [Exploring Graphs with Path Plot](#).

## Graphing Polar Equations

1. From the **Graph Entry/Edit** menu, select **Polar**.

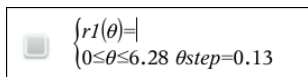

$$\begin{cases} r1(\theta)=| \\ 0 \leq \theta \leq 6.28 \quad \thetastep=0.13 \end{cases}$$

2. Type an expression for  $rn(\theta)$ .
3. (Optional) Edit the default values for  $\theta min$ ,  $\theta max$ , and  $\theta step$ .

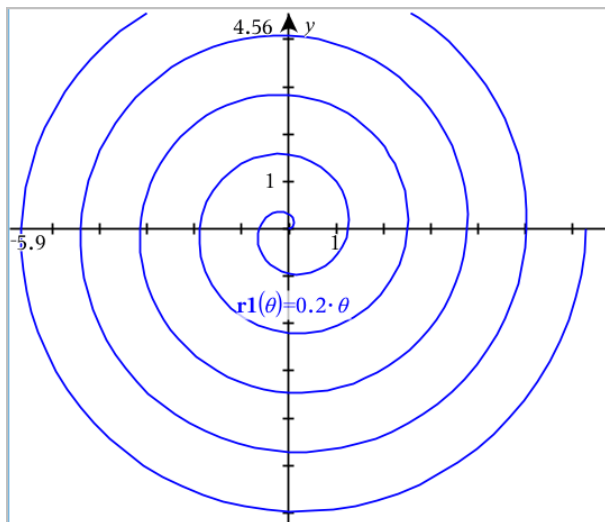

$$\begin{cases} r1(\theta) = .2 \cdot \theta \\ 0 \leq \theta \leq (\pi \cdot 10) \end{cases} \theta \text{step} = 0.13$$

4. Press **Enter**.



**Note:** For information about path plots, see [Exploring Graphs with Path Plot](#).

### Graphing Scatter Plots

- (Optional) Create two predefined list variables containing the x and y values to plot. You can use the Lists & Spreadsheet, Calculator, or Notes application to create the lists.

A v1	B v2	C	D
1	2		
2	4		
3	8		
4	16		
5	32		

- From the **Graph Entry/Edit** menu, select **Scatter Plot**.

Use the up and down arrow keys to move between the x and y fields.

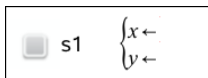

- Use one of the following methods to specify lists to plot as x and y.
  - Click  to select names of the predefined list variables.
  - Type the names of the variables, such as  $v1$ .
  - Type lists as comma-separated elements enclosed within brackets, for example:  $\{1,2,3\}$ .

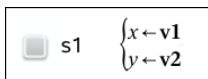

- Press **Enter** to plot the data, and then [zoom the work area](#) to view the plotted data.

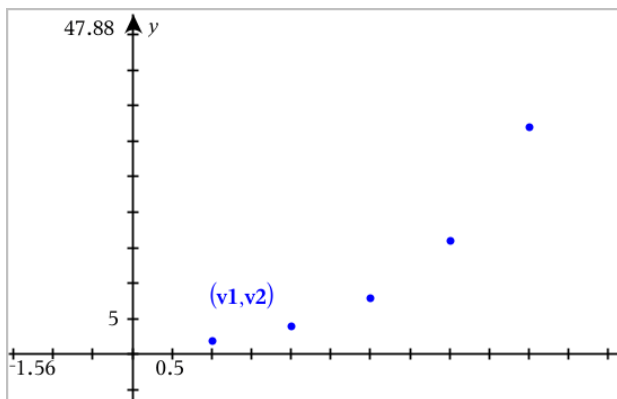

## Plotting Sequences

The Graphs application lets you plot two types of sequences. Each type has a separate template for defining the sequence.

### Defining a Sequence

- From the **Graph Entry/Edit** menu, select **Sequence > Sequence**.

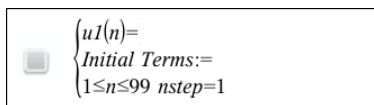

- Type the expression to define the sequence. Update the independent variable field to  $m+1$ ,  $m+2$ , etc., if necessary.
- Type an initial term. If the sequence expression references more than one prior term, such as  $u1(n-1)$  and  $u1(n-2)$ , (or  $u1(n)$  and  $u1(n+1)$ ), separate the terms with commas.



$$\begin{cases} u1(n)=1.1 \cdot u1(n-1)+1 \\ \text{Initial Terms}:=1 \\ 1 \leq n \leq 99 \quad n\text{step}=1 \end{cases}$$

4. Press **Enter**.

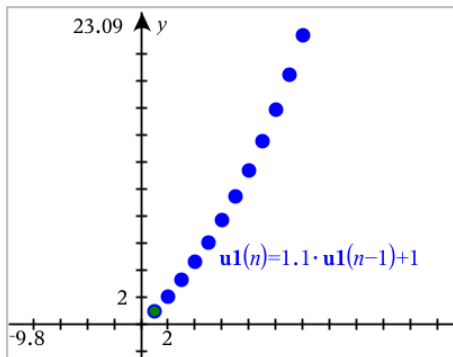

### Defining a Custom Sequence

A custom sequence plot shows the relationship between two sequences by plotting one on the x axis and the other on the y axis.

This example simulates the Predator-Prey model from biology.

1. Use the relations shown here to [define two sequences](#): one for a rabbit population, and another for a fox population. [Replace the default sequence names](#) with **rabbit** and **fox**.



$$\begin{cases} \mathbf{rabbit}(n)=\mathbf{rabbit}(n-1) \cdot (1+0.05-0.001 \cdot \mathbf{fox}(n-1)) \\ \text{Initial Terms}:=200 \\ 1 \leq n \leq 400 \quad n\text{step}=1 \end{cases}$$



$$\begin{cases} \mathbf{fox}(n)=\mathbf{fox}(n-1) \cdot (1+2 \cdot E-4 \cdot \mathbf{rabbit}(n-1)-0.03) \\ \text{Initial Terms}:=50 \\ 1 \leq n \leq 400 \quad n\text{step}=1 \end{cases}$$

.05 = the growth rate of rabbits if there are no foxes

.001 = the rate at which foxes can kill rabbits

.0002 = the growth rate of foxes if there are rabbits

.03 = the death rate of foxes if there are no rabbits

**Note:** If you want to see the plots of the two sequences, [zoom the window](#) to the **Zoom - Fit** setting.

2. From the **Graph Entry/Edit** menu, select **Sequence > Custom**.
3. Specify the **rabbit** and **fox** sequences to plot on the x and y axes, respectively.

p1
 
$$\begin{cases} x \leftarrow \text{rabbit}(n) \\ y \leftarrow \text{fox}(n) \\ 1 \leq n \leq 400 \text{ nstep}=1 \end{cases}$$

4. Press **Enter** to create the custom plot.
5. [Zoom the window](#) to the **Zoom - Fit** setting.

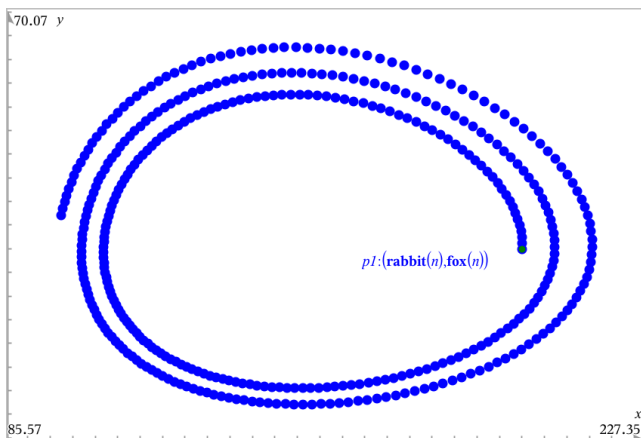

6. Explore the custom plot by dragging the point that represents the initial term.

### Graphing Differential Equations

You can study linear and non-linear differential equations and systems of ordinary differential equations (ODEs), including logistic models and Lotka-Volterra equations (predator-prey models). You can also plot slope and direction fields with interactive implementations of Euler and Runge-Kutta methods.

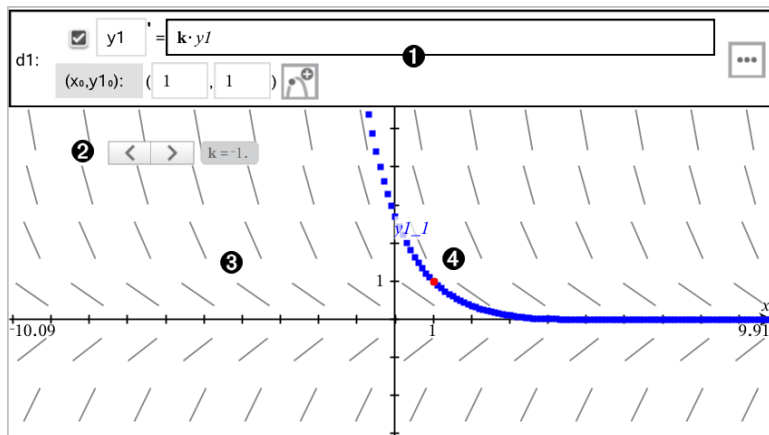

- 1 ODE entry line:
  - **y1** ODE identifier
  - Expression **k·y1** defines the relation
  - Fields **(1,1)** for specifying initial condition
  - Buttons for adding initial conditions and setting plot parameters
- 2 Slider to vary coefficient **k** of the ODE
- 3 Slope field
- 4 A solution curve passing through the initial condition

### To Graph a Differential Equation:

1. From the **Graph Entry/Edit** menu, select **Diff Eq.**

The ODE is automatically assigned an identifier, such as “y1.”

2. Move to the relation field and enter the expression that defines the relation. For example, you might enter  $-y1+0.1*y1*y2$ .

3. Enter the initial condition for the independent value  $x_0$  and for  $y_{10}$ .

**Note:** The  $x_0$  value(s) are common to all the ODEs in a problem but can be entered or modified only in the first ODE.

4. (Optional) To study multiple initial conditions for the current ODE, click Add Initial Conditions  and enter the conditions.



5. Tap Edit Parameters  to set the plot parameters. Select a numerical Solution Method, and then set any additional parameters. You can change these parameters anytime.

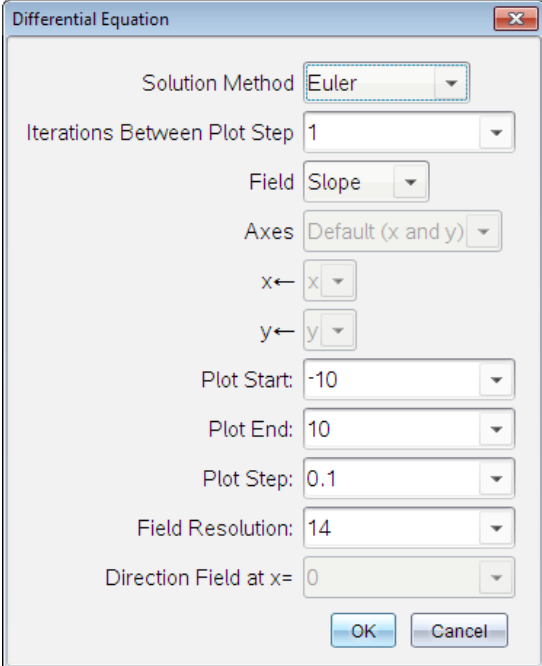

6. Click **OK**.
7. To enter additional ODEs, press the down arrow to display the next ODE edit field.

As you move among defined ODEs, the graph is updated to reflect any changes. One solution to the ODE is graphed for each IC specified for each shown ODE (selected by check box).

### Summary of Differential Equation Settings

<b>Solution Method</b>	Selects Euler or Runge-Kutta as the numerical solution method.
<b>Iterations Between Plot Step</b>	Computational accuracy for Euler solution method only. Must be an integer value >0. To restore the default, select the down-arrow and select <b>Default</b> .
<b>Error Tolerance</b>	Computational accuracy for Runge-Kutta solution method only. Must be a floating-point value $\geq 1 \times 10^{-14}$ . To restore the default, select the down-arrow and select <b>Default</b> .

<b>Field</b>	<p><b>None</b> - No field is plotted. Available for any number of ODEs, but required if three or more 1st-order ODEs are active. Graphs a combination of the solution and/or values of one or more ODEs (according to user-configured <b>Axes</b> settings).</p> <p><b>Slope</b> - Plots a field representing the family of solutions to a single 1st-order ODE. Exactly one ODE must be active. Sets <b>Axes</b> to <b>Default (x and y)</b>. Sets Horizontal axis to x (the independent variable). Sets Vertical axis to y (the solution to the ODE).</p> <p><b>Direction</b> - Graphs a field in the phase plane representing the relationship between a solution and/or values of a system of two 1st-order ODEs (as specified by the <b>CustomAxes</b> setting). Exactly two ODEs must be active.</p>
<b>Axes</b>	<p><b>Default (x and y)</b> - Plots x on the x axis and y (the solutions to the active differential equations) on the y axis.</p> <p><b>Custom</b> - Lets you select the values to be plotted on the x and y axes respectively. Valid entries include:</p> <ul style="list-style-type: none"> <li>• x (the independent variable)</li> <li>• y1, y2, and any identifiers defined in the ODE editor</li> <li>• y1', y2', and any derivatives defined in the ODE editor</li> </ul>
<b>Plot Start</b>	Sets the independent variable value at which the solution plot starts.
<b>Plot End</b>	Sets the independent variable value at which the solution plot stops.
<b>Plot Step</b>	Sets the increment of the independent variable at which values are plotted.
<b>Field Resolution</b>	Sets the number of columns of field rendering elements (line segments) used to draw a slope or direction field. You can change this parameter only if <b>Field = Direction</b> or <b>Slope</b> .
<b>Direction Field at x=</b>	Sets the independent variable value at which a direction field is drawn when plotting non-autonomous equations (those that refer to x). Ignored when plotting autonomous equations. You can change this parameter only if <b>Field = Direction</b> .

## Viewing Tables from the Graphs Application

You can show a table of values for any relation defined in the current problem.

**Note:** For details about using tables and instructions for accessing tables from the Lists & Spreadsheet application, see [Working with Tables](#).

### Showing a Table

- ▶ From the **Table** menu, select **Split-screen Table**.

The table is displayed with columns of values for the currently defined relations.

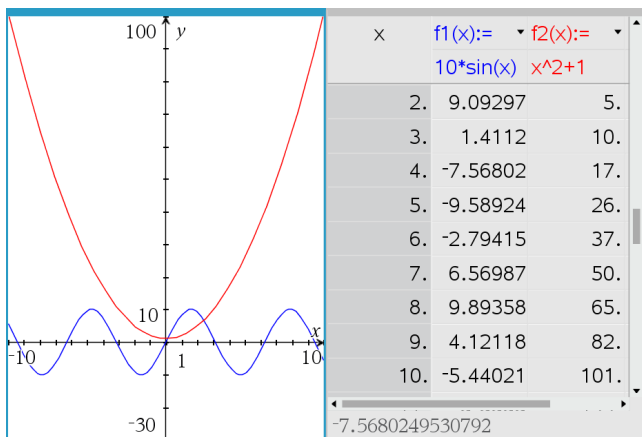

To change which relation is displayed in a column, click the arrow in the top cell of the column, and then select the relation name.

### Hiding the Table

- ▶ From the **Table** menu, select **Remove Table**.

### Editing Relations

1. Double-click the graph to show its expression in the entry line.  
—or—  
Display the graph's context menu, and then click **Edit Relation**.

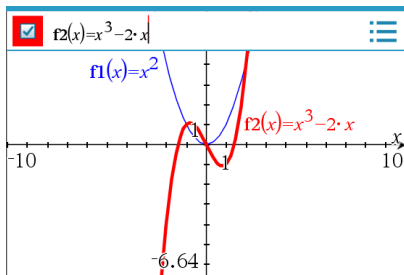

2. Modify the expression as needed.



3. Press **enter** to graph the revised function.

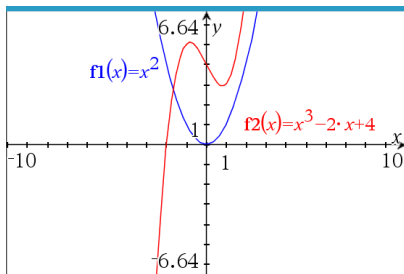

### Renaming a Relation

Each relation type has a default naming convention. For example, the default name for functions is  $f_n(x)$ . (The number represented by  $n$  increases as you create more functions.) You can replace the default name with a name of your choice.

**Note:** If you want to use a custom name as a convention, you must enter it manually for each function.

1. In the entry line, delete the existing name. For example, delete the "f1" from "f1(x)". You can use the right and left arrow keys to position the cursor.

2. Type the replacement name.

3. If you are defining a new relation, position the cursor after the = sign and type the expression.

4. Press **Enter** to graph the relation with its new name.

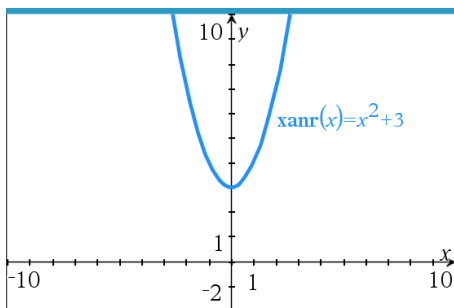

### Accessing the Graph History

For each problem, the software stores a history of relations defined in the Graphs application and 3D Graphing view, such as function graphs **f1** through **f99** and 3D

function graphs **z1** through **z99**. You can view and edit these items using a button on the entry line.

### Viewing the History

1. Press **Ctrl+G** to show the entry line.
2. Click the **History Menu** button  on the entry line.

The menu is displayed. As you point to the name of each item, its expression appears in the entry line.

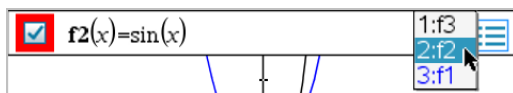

3. Select the name of the relation you want to view or edit.
4. (Optional) From the entry line, use the up and down arrow keys to scroll through the defined relations of the same type.

### Viewing the History of Specific Relation Types

Use this method if you want to view or edit a defined relation that does not appear in the History menu.

1. On the **Graph Entry/Edit** menu, click the relation type. For example, click **Polar** to show the entry line for the next available Polar relation.
2. Click the **History Menu** button , or use the up and down arrow keys to scroll through the defined relations of the same type.

## Zooming/Rescaling the Graphs Work Area

Rescaling in the Graphs application affects only the graphs, plots, and objects that reside in the Graphing view. It has no effect on objects in the underlying Plane Geometry view.

### Rescaling by Dragging Along an Axis

- ▶ To rescale the x and y axes proportionally, drag a tic mark on either axis.
- ▶ To rescale only one axis, hold down **Shift** and drag a tic mark on the axis.

### Zooming Using a Zoom Tool

- ▶ From the **Window / Zoom** menu, select one of the tools.
  - **Zoom - Box** (Click two corners of a box to define the area to show.)
  - **Zoom - In**
  - **Zoom - Out**

### Zooming to Predefined Settings

- ▶ From the **Window / Zoom** menu, select one of the predefined Zoom settings.

- Zoom - Standard
- Zoom - Quadrant 1
- Zoom - Standard User
- Zoom - Standard Trig
- Zoom - Standard Data
- Zoom - Fit

### Entering Custom Window Settings

1. From the **Window / Zoom** menu, select **Window Settings**.
2. Enter a value for each setting. You can use expressions for exact input, as shown below.

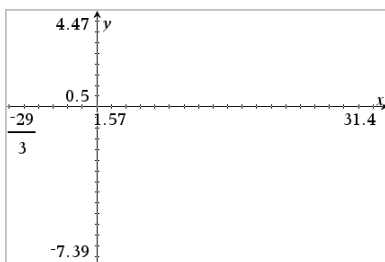

*On TI-Nspire™ products, fractional input is preserved as-is. Other exact inputs are replaced with the evaluated result.*

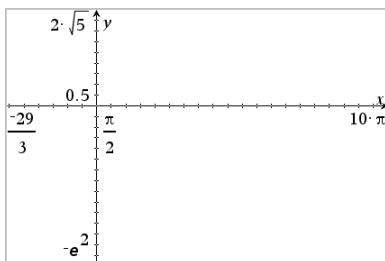

*On TI-Nspire™ Exact Arithmetic and CAS products, fractional and other exact inputs are preserved.*

## Customizing the Graphs Work Area

### Inserting a Background Image

You can [insert an image](#) as a background for any Graphs or Geometry page.

1. From the **Insert** menu, click **Image**.
2. Navigate to the image you want to insert, select it, and then click **Open**.

### Adding a Text Object to the Work Area

Use the Text tool to add numeric values, formulas, observations, or other explanatory information to the Graphs work area. You can graph an equation entered as text (such as " $x=3$ ").

1. From the **Actions** menu, select **Text**.
2. Click the location for the text.
3. Type the text in the box that appears, and then press **Enter**.

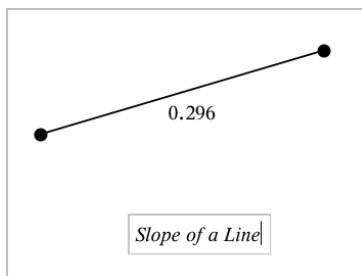

To move a text object, drag it. To edit the text, double-click it. To delete a text object, display its context menu, and select **Delete**.

### Changing the Attributes of Numeric Text

If you enter a numeric value as text, you can lock it or set its format and displayed precision.

1. From the **Actions** menu, select **Attributes**.
2. Click the numeric text to display its list of attributes.
3. Press **▲** and **▼** to move through the list.
4. At each attribute icon, press **◀** or **▶** to move through the options. For example, select **0** through **9** as the precision.
5. Press **Enter** to apply the changes.
6. Press **Esc** to close the Attributes tool.

### Displaying the Grid

By default, the grid is not displayed. You can choose to display it as dots or lines.

- ▶ From the **View** menu, select **Grid**, and then select **Dot Grid**, **Lined Grid**, or **No Grid**.

## Changing the Grid Color

1. From the **Actions** menu, choose **Select > Grid** (available only when the grid is displayed).

The grid flashes to show it is selected.

2. Click the down arrow next to the Color button, and select a color for the grid.



## Changing the Appearance of the Graph Axes

1. From the **Actions** menu, click **Attributes**.
2. Click either axis.
3. Press **▲** and **▼** to move to the desired attribute, and then press **◀** and **▶** to choose the option to apply.

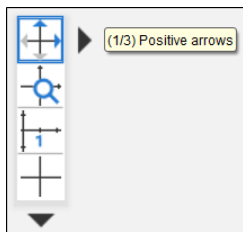

**Note:** To hide the axes or selectively hide or show an individual axis end-value, use the [Hide/Show tool](#).

To display multiple tick mark labels, select the **Multiple Labels** option.

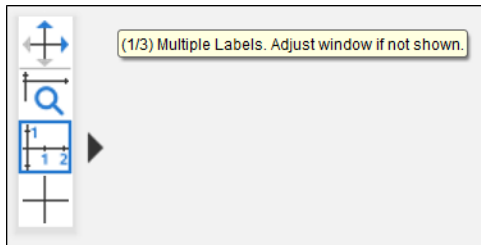



Multiple labels are only displayed if they fit both horizontally and vertically on the axes. If necessary, adjust the values in the **Window / Zoom > Window Settings** dialog.

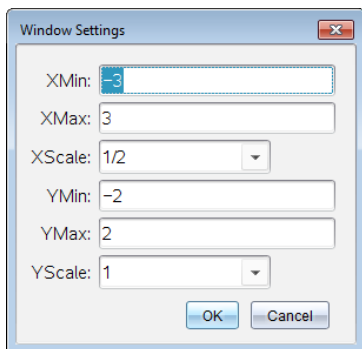

Window Settings

XMin: -3

XMax: 3

XScale: 1/2

YMin: -2

YMax: 2

YScale: 1

OK Cancel

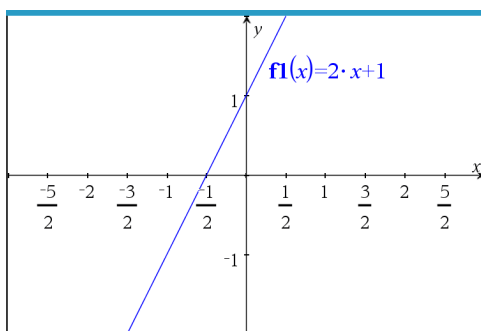

**Exact Arithmetic and CAS Only:** You can change the tick mark labels to display multiples of Pi, radical numbers, and other exact values by editing the **XScale** or **YScale** values in the **Window / Zoom > Window Settings** dialog. See the following example.

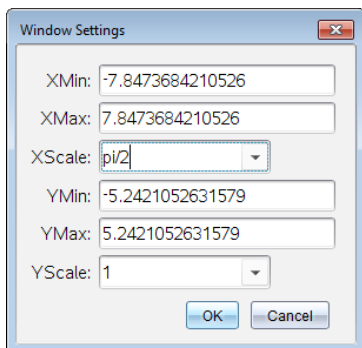

Window Settings

XMin: -7.8473684210526

XMax: 7.8473684210526

XScale: pi/2

YMin: -5.2421052631579

YMax: 5.2421052631579

YScale: 1

OK Cancel

**Note:** pi/2 will be converted to  $\pi/2$  after clicking **OK**.

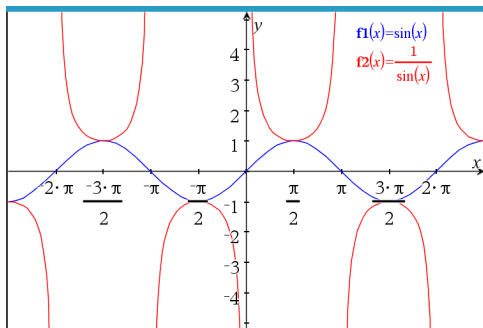

**Note:** For information about path plots, see [Exploring Graphs with Path Plot](#).

### ***Hiding and Showing Items in the Graphs Application***

The Hide/Show tool reveals objects you have previously selected as hidden and lets you select which objects to show or hide.

**Note:** If you hide a graph, its expression is automatically marked as hidden in the [graph history](#).

1. From the **Actions** menu, select **Hide/Show**.

The Hide/Show tool appears at the top of the work area, and currently hidden items (if any) are shown dimmed.

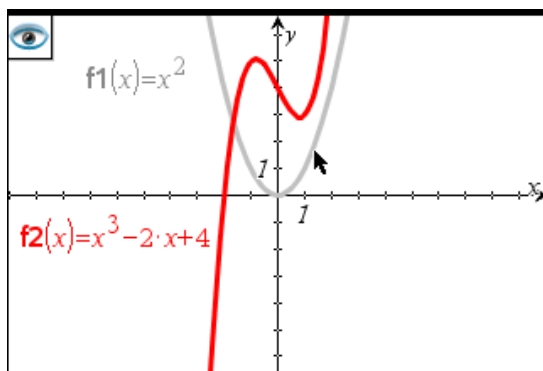

2. Click objects to toggle their hide/show status. You can hide graphs, geometric objects, text, labels, measurements, and individual axis end-values.
3. Press **Esc** to complete your selections and close the tool.

All objects you selected as hidden objects disappear.

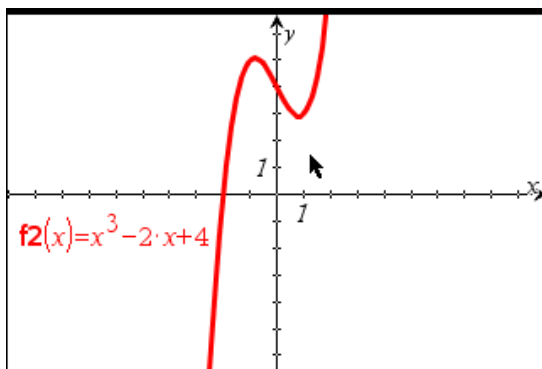

- To view the hidden objects temporarily or restore them as shown objects, open the Hide/Show tool.

### Conditional Attributes

You can cause objects to hide, show, and change color dynamically, based on specified conditions such as " $r1 < r2$ " or " $\sin(a1) \geq \cos(a2)$ ."

For example, you might want to hide an object based on a changing measurement that you have assigned to a variable, or you might want an object's color to change based on a "Calculate" result assigned to a variable.

Conditional behaviors can be assigned to objects or groups in the Graphing, Plane Geometry, and 3D Graphing views.

#### Setting Conditional Attributes of an Object

You can set conditions of a selected object either by using its context menu or by activating the Set Conditions tool from the **Actions** menu and then selecting the object. These instructions describe using the context menu.

- Select the object or group.
- Display the object's context menu, and click **Conditions**.

The conditional attributes are displayed.

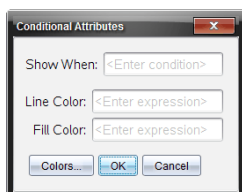

For 2D objects

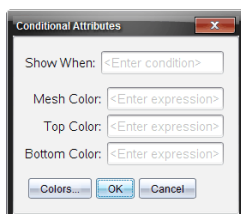

For 3D objects

- (Optional) In the **Show When** field, enter an expression specifying the conditions during which the object will be shown. Anytime the condition is not satisfied, the object will be hidden.

You can specify tolerance by using compound conditionals in the **Show When** input field. For example, `area>=4 and area<=6`.

**Note:** If you need to see conditionally hidden objects temporarily, click **Actions > Hide/Show**. To return to normal viewing, press **ESC**.

- (Optional) Enter numbers or expressions that evaluate to numbers in the applicable color fields, such as **Line Color** or **Mesh Color**. To see a map of color values, click the **Colors** button.

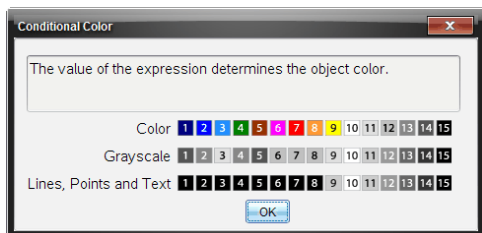

*Map of conditional color values*

- Click **OK** in the Conditional Attributes dialog box to apply the conditions.

## **Calculating a Bounded Area**

**Note:** To avoid unexpected results when using this feature, make sure the document setting for "Real or Complex Format" is set to **Real**.

When you calculate the area between curves, each curve must be:

- A function with respect to  $x$ .
- or -
- An equation in the form  $y=$ , including  $y=$  equations defined through a text box or a conic equation template.

### **Defining and Shading the Area**

- From the **Analyze Graph** menu, select **Bounded Area**.

If exactly two appropriate curves are available, they are selected automatically, and you can skip to step 3. Otherwise, you are prompted to select two curves.

- Click two curves to select them.  
– or –  
Click one curve and the  $x$  axis.

You are prompted to set the lower and upper bounds.

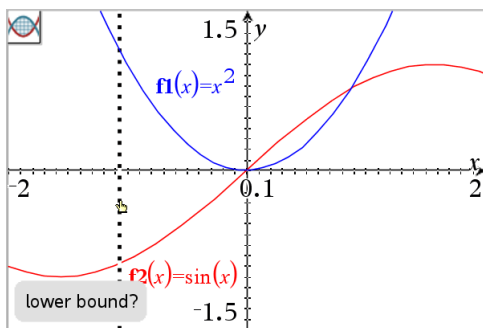

- Click two points to define the bounds. Optionally, you can type numeric values.

The area becomes shaded, and the area value is displayed. The value is always non-negative, regardless of the interval direction.

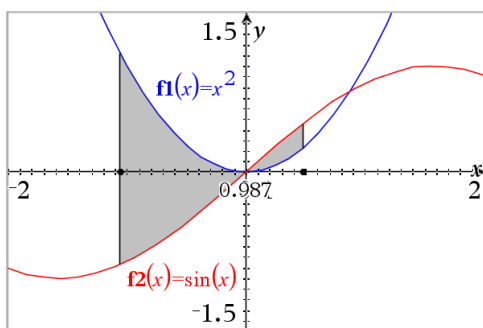

### Working with Shaded Areas

As you change the bounds or redefine the curves, the shading and the area value are updated .

- To change the lower or upper bound, drag it or type new coordinates for it. You cannot move a bound that resides on an intersection. However, the point moves automatically as you edit or manipulate the curves.
- To redefine a curve, either manipulate it by dragging or edit its expression in the entry line.

If an endpoint resided originally on an intersection, and the redefined functions no longer intersect, the shading and area value disappear. If you redefine the function (s) so that there is an intersection point, the shading and area value reappear.

- To delete or hide the shaded area, or to change its color and other attributes, display its context menu.
  - Windows®: Right-click the shaded area.
  - Mac®: Hold  $\mathcal{C}$  and click the shaded area.

- Handheld: Move the pointer to the shaded area and press **ctrl** .

## Tracing Graphs or Plots

Graph Trace lets you move a trace cursor over the points of a graph or plot and displays value information.

### Tracing Specific Graphs

1. From the **Trace** menu, select **Graph Trace**.

The Graph Trace tool appears at the top of the work area, the trace cursor appears, and the cursor coordinates are displayed in the lower right corner.

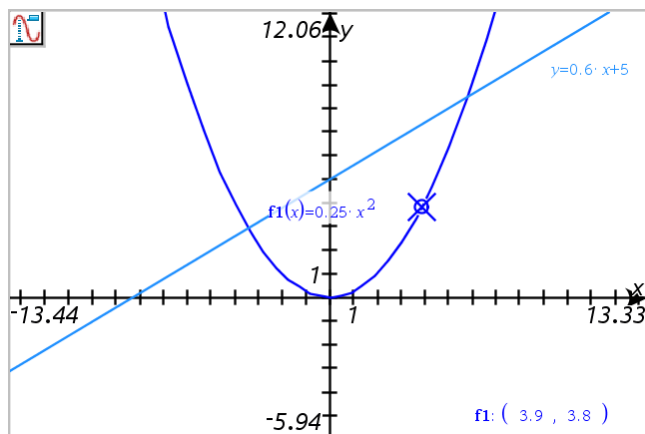

2. Explore a graph or plot:

- Point to a position on a graph or plot to move the trace cursor to that point.
- Press **◀** or **▶** to step the cursor along the current graph or plot. The screen pans automatically to keep the cursor in view.
- Press **▲** or **▼** to cycle among the displayed graphs.
- Click the trace cursor to create a persistent point. Optionally, enter a specific independent value to move the trace cursor to that value.

3. To stop tracing, press **Esc**.

### Tracing All Graphs

The Trace All tool allows tracing multiple functions simultaneously. With several functions graphed on the work area, perform the following steps:

**Note:** The Trace All tool traces only function graphs, not plots of other relations (polar, parametric, scatter, sequence).

1. From the **Trace** menu, select **Trace All**.

The Trace All tool appears in the work area, a vertical line indicates the x value of the trace, and the coordinates for each traced point are displayed in the lower right corner.

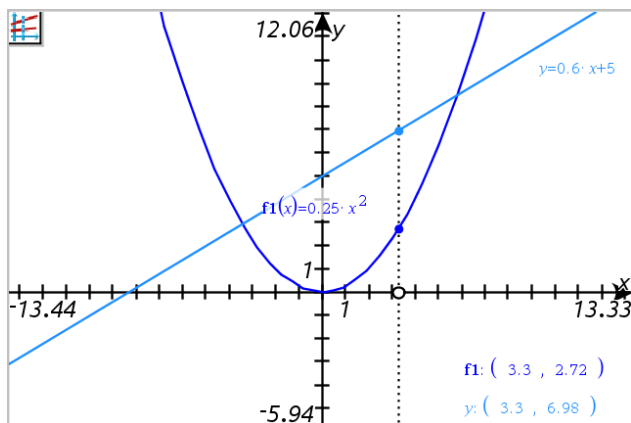

2. Explore the graphs:
  - Click a point on the x axis to move all the trace points to that x value.
  - Press  $\blacktriangleleft$  or  $\blacktriangleright$  to step the trace points along all the graphs.
3. To stop tracing, press **Esc**.

### Changing the Trace Step

1. From the **Trace** menu, select **Trace Step**.

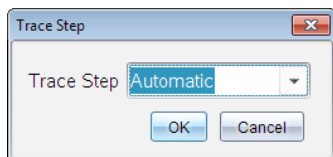

2. Choose Automatic or enter a specific step size for tracing.

## Introduction to Geometric Objects

Geometry tools are accessible in both the Graphs and Geometry applications. You can use these tools to draw and investigate objects such as points, lines, and shapes.

- The Graphing view shows the Graphs work area superimposed on the Geometry work area. You can select, measure, and alter objects in both work areas.
- The Plane Geometry view shows only the objects created in the Geometry application.

### Objects Created in the Graphs Application

Points, lines, and shapes created in the Graphs application are analytic objects.

- All points that define these objects reside on the x,y graph plane. Objects created here are visible only in the Graphs application. Changing the axes scale affects the appearance of the objects.
- You can display and edit the coordinates of any point on an object.
- You can display the equation of a line, tangent line, circle shape, or geometric conic created in the Graphs application.

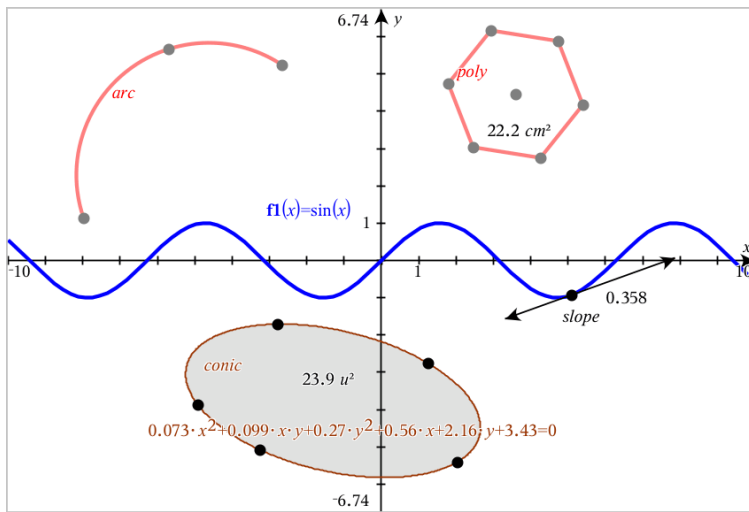

The circle arc and polygon were created in the Geometry application. The sine wave and conic were created in the Graphs application.



## Objects Created in the Geometry Application

Points, lines, and shapes created in the Geometry application are not analytic objects.

- Points that define these objects do not reside on the graph plane. Objects created here are visible in both the Graphs and Geometry applications, but they are unaffected by changes to the Graphs  $x,y$  axes.
- You cannot obtain the coordinates of an object's points.
- You cannot display the equation of a geometric object created in the Geometry application

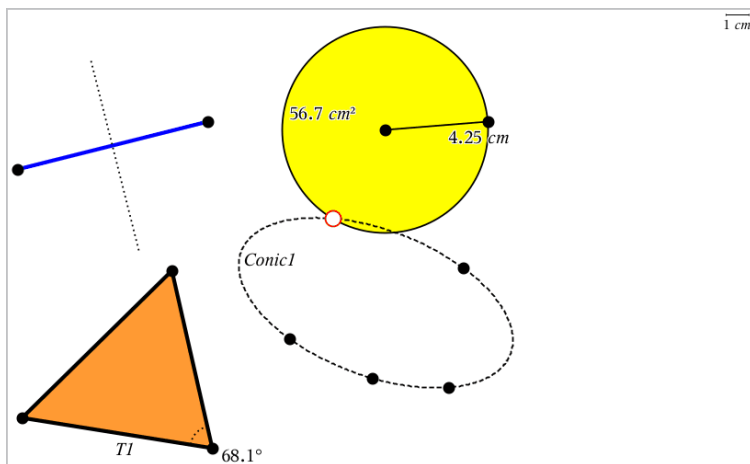

## Creating Points and Lines

As you create an object, a tool appears in the work area (for example, **Segment** ). To cancel, press **ESC**. To enable automatic labeling of certain objects, see *What You Must Know* in this chapter.

### Creating a Point on the Work Area

1. From the **Points and Lines** menu, select **Point**. (In the Graphs application, click **Geometry > Points and Lines > Point**.)
2. Click a location to create the point.
3. (Optional) Label the point.
4. To move a point, drag it.

## Creating a Point on a Graph or Object

You can create a point on a line, segment, ray, axis, vector, circle, graph, or axis.

1. From the **Points and Lines** menu, select **Point On**. (In the Graphs application, click **Geometry > Points and Lines > Point On**.)
2. Click the graph or object on which you want to create the point.
3. Click a location on the object to place the point.

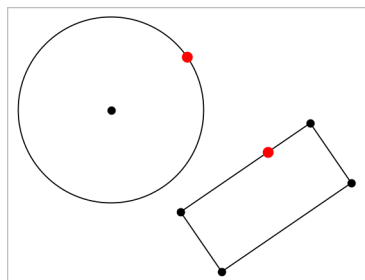

## Creating a Dynamic Point on a Graph

You can create a dynamic point on a graph with Point by Coordinates.

1. From the **Points and Lines** menu, select **Point by Coordinates**. (In the Graphs application, click **Geometry > Points and Lines > Point by Coordinates** or press **P** and select **Point by Coordinates**).

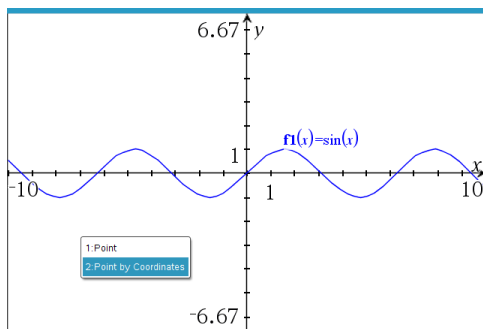

2. Enter the variables or expressions for one or both of the coordinates.

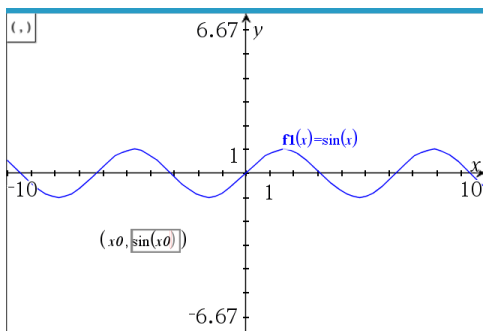

3. Use the slider that is created to move the point on the graph.

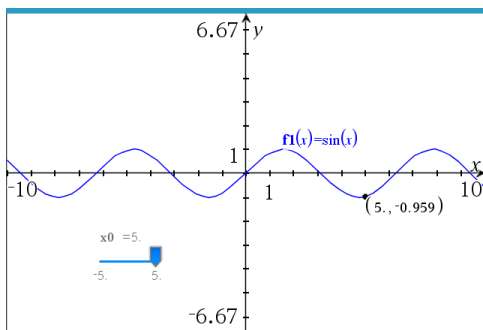

The point will display the actual coordinates. If you hover the cursor over a coordinate, it will display the variable or expression.

To edit the point, double-click the coordinate on the label. Any variable or expression that was entered before is retained.

### Identifying Points of Intersection

1. From the **Points and Lines** menu, select **Intersection Points**. (In the Graphs application, click **Geometry > Points and Lines > Intersection Points**.)
2. Click two intersecting objects to add points at their intersections.

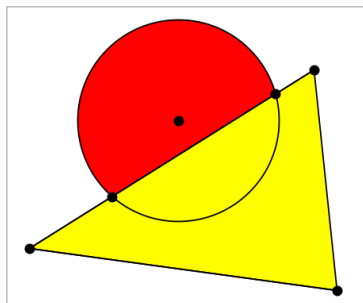

### Creating a Line

1. From the **Points and Lines** menu, select **Line**. (In the Graphs application, click **Geometry > Points and Lines > Line**.)
2. Click a location to define one point on the line.
3. Click a second location to define the direction of the line and the length of its visible portion.

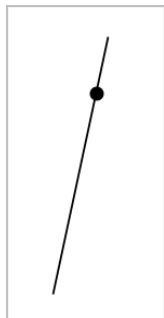

4. To move a line, drag its identifying point. To rotate it, drag any point except the identifying point or ends. To extend its visible portion, drag from either end.

### Creating a Segment

1. From the **Points and Lines** menu, select **Segment**. (In the Graphs application, click **Geometry > Points and Lines > Segment**.)
2. Click two locations to define the endpoints of the segment.

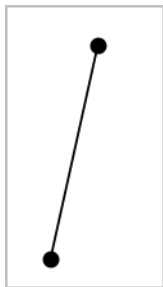

3. To move a segment, drag any point other than an endpoint. To manipulate the direction or length, drag either endpoint.

### Creating a Ray

1. From the **Points and Lines** menu, select **Ray**. (In the Graphs application, click **Geometry > Points and Lines > Ray**.)
2. Click a location to define the endpoint of the ray.
3. Click a second location to define the direction.



To move a ray, drag its identifying point. To rotate it, drag any point except the identifying point or end. To extend its visible portion, drag from the end.

### Creating a Tangent

You can create a tangent line at a specific point on a geometric object or function graph.

1. From the **Points and Lines** menu, select **Tangent**. (In the Graphs application, click **Geometry > Points and Lines > Tangent**.)
2. Click the object to select it.

- Click a location on the object to create the tangent.

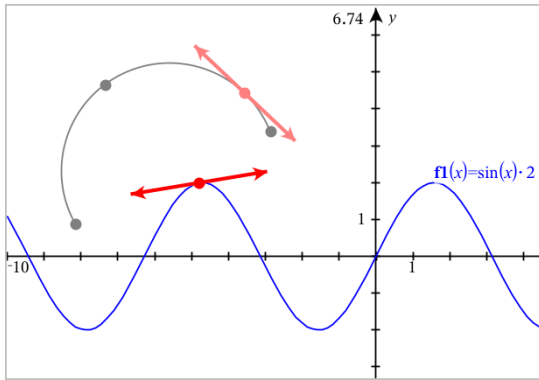

- To move a tangent, drag it. It remains attached to the object or graph.

### Creating a Vector

- From the **Points and Lines** menu, select **Vector**. (In the Graphs application, click **Geometry > Points and Lines > Vector**.)
- Click a location to establish the vector's initial point.
- Click a second location to specify direction and magnitude and complete the vector.

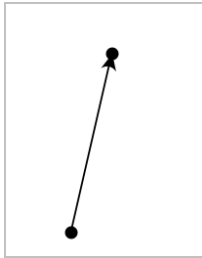

- To move a vector, drag any point other than the endpoints. To manipulate the magnitude and/or direction, drag either end point.

**Note:** If you create an endpoint on an axis or another object, you can move the endpoint only along that object.

### Creating a Circle Arc

- From the **Points and Lines** menu, select **Circle Arc**. (In the Graphs application, click **Geometry > Points and Lines > Circle Arc**.)

2. Click a location or point to establish the starting point of the arc.
3. Click a second point to establish an intermediate point through which the arc will pass.
4. Click a third point to set the ending point and complete the arc.

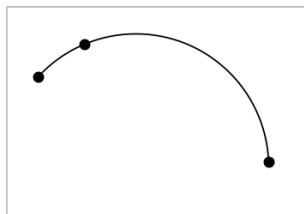

5. To move an arc, drag its perimeter. To manipulate it, drag any of its three defining points.

## ***Creating Geometric Shapes***

The Shape tools let you explore circles, polygons, conics, and other geometric objects.

As you create a shape, a tool appears in the work area (for example, **Circle** ). To cancel the shape, press **ESC**. To enable automatic labeling of certain objects, see *What You Must Know*, in this chapter.

### **Creating a Circle**

1. From the **Shapes** menu, select **Circle**. (In the Graphs application, click **Geometry > Shapes > Circle**.)
2. Click a location or point to position the circle's center point.
3. Click a location or point to establish the radius and complete the circle.

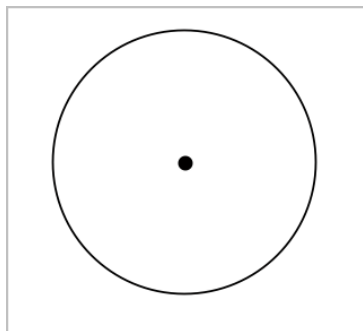

4. To resize a circle, drag its perimeter. To move it, drag its center point.

## Creating a Triangle

**Note:** To ensure that the sum of the angles of a triangle equals  $180^\circ$  or 200 gradians, you can force integer angles in the Geometry view. Refer to *What You Must Know*, in this chapter.

1. From the **Shapes** menu, select **Triangle**. (In the Graphs application, click **Geometry > Shapes > Triangle**.)
2. Click three locations to establish the vertices of the triangle.

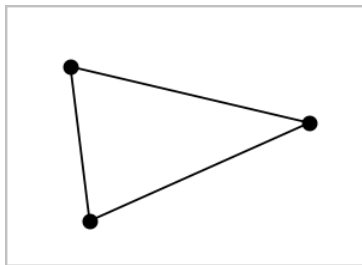

3. To manipulate a triangle, drag any point. To move it, drag any side.

## Creating a Rectangle

1. From the **Shapes** menu, select **Rectangle**. (In the Graphs application, click **Geometry > Shapes > Rectangle**.)
2. Click a location or point to establish the first corner of the rectangle.
3. Click a location for the second corner.

One side of the rectangle is displayed.

4. Click to establish the distance to the opposite side and complete the rectangle.

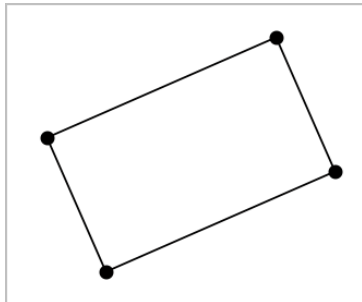



5. To rotate a rectangle, drag one of its first two points. To extend it, drag one of the last two points. To move it, drag any side.

### Creating a Polygon

1. From the **Shapes** menu, select **Polygon**. (In the Graphs application, click **Geometry > Shapes > Polygon**.)
2. Click a location or point to establish the first vertex of the polygon.
3. Click to establish each additional vertex.
4. To complete the polygon, click the first vertex.

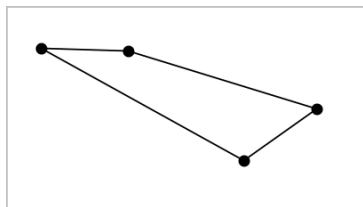

5. To manipulate a polygon, drag any vertex. To move it, drag any side.

### Creating a Regular Polygon

1. From the **Shapes** menu, select **Regular Polygon**. (In the Graphs application, click **Geometry > Shapes > Regular Polygon**.)
2. Click once on the work area to establish the center point.
3. Click a second location to establish the first vertex and radius.

A 16-sided regular polygon is formed. The number of sides is displayed in brackets; for example, {16}.

4. Drag any vertex in a circular motion to set the number of sides.
  - Drag clockwise to reduce the number of sides.
  - Drag counterclockwise to add diagonals.

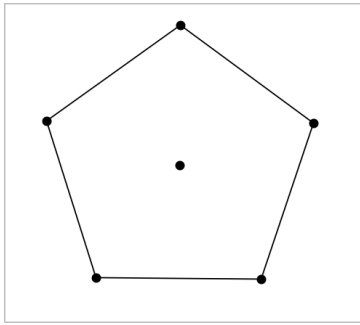

5. To resize or rotate a regular polygon, drag any of its points. To move it, drag any side.

### Creating an Ellipse

1. From the **Shapes** menu, select **Ellipse**. (In the Graphs application, click **Geometry > Shapes > Ellipse**.)
2. Click two locations or points to establish the foci.
3. Click to establish a point on the ellipse and complete the shape.

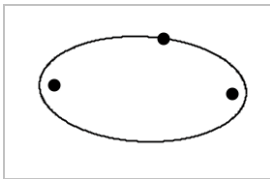

4. To manipulate an ellipse, drag any of its three defining points. To move it, drag its perimeter.

### Creating a Parabola (from focus and vertex)

1. From the **Shapes** menu, select **Parabola**. (In the Graphs application, click **Geometry > Shapes > Parabola**.)
2. Click a location to establish the focus.
3. Click a location to establish the vertex and complete the parabola.

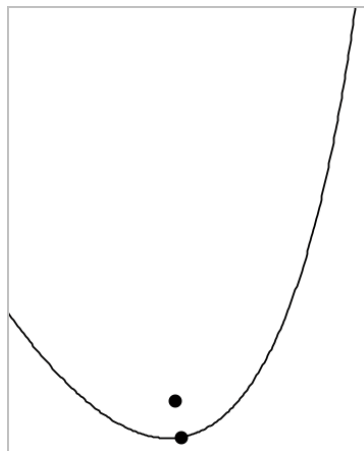

4. To manipulate a parabola, drag its focus or its vertex. To move it, drag it from any other point.

#### Creating a Parabola (from focus and directrix)

1. Create a line to serve as the directrix.
2. From the **Shapes** menu, select **Parabola**. (In the Graphs application, click **Geometry > Shapes > Parabola**.)
3. Click a location to establish the focus.
4. Click the line to establish it as the directrix.

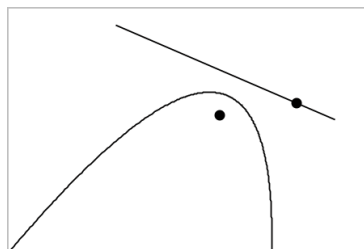

5. To manipulate a parabola, rotate or move its directrix or drag its focus. To move it, select both the directrix and the focus, and then drag either object.

#### Creating a Hyperbola

1. From the **Shapes** menu, select **Hyperbola**. (In the Graphs application, click **Geometry > Shapes > Hyperbola**.)

- Click two locations to establish the foci.
- Click a third location to complete the hyperbola.

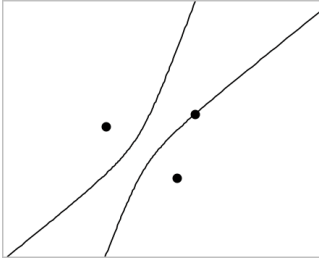

- To manipulate a hyperbola, drag any of its three defining points. To move it, drag it from any other place on the shape.

### Creating a Conic by Five Points

- From the **Shapes** menu, select **Conic by Five Points**. (In the Graphs application, click **Geometry > Shapes > Conic by Five Points**.)
- Click five locations to establish the five points on the shape.

Depending on the pattern of the points, the conic can be a hyperbola or an ellipse.

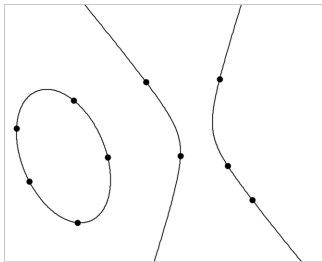

- To manipulate a conic, drag any of its five defining points. To move it, drag it from any other place on the shape.

### Creating Shapes Using Gestures (MathDraw)

The MathDraw tool lets you use touchscreen or mouse gestures to create points, lines, circles, and other shapes.

MathDraw is available in:

- Geometry view without the analytic window displayed.

- Graphing view when the x scale and y scale are identical. This avoids non-circular ellipses and non-square rectangles appearing as circles and squares.

MathDraw is not available in the 3D Graphing view or in the Geometry view with the analytic window displayed.

### Activating MathDraw

1. If using the Geometry view with the analytic window visible, use the **View** menu to hide the window.
2. On the **Actions** menu, select **MathDraw**.

The MathDraw icon  appears. You can begin using the tool.

### Canceling MathDraw

- ▶ When you have finished using the MathDraw tool, press **Esc**.

The tool also closes if you select a different tool or change views.

### Creating Points

To create a labeled point, tap or click in an open area.

- If the point is close to an existing line, segment, ray, geometric conic (including circles), or polygon, the point snaps to that object. You can also place a point on the intersection of any two of those types of objects.
- If the point is close to a visible grid location in a Graphs view or the analytic window of a Geometry view, it snaps to the grid.

### Drawing Lines and Segments

To create a line or segment, touch or click the initial position, and then drag to the end position.

- If the drawn line passes near an existing point, the line snaps to the point.
- If the drawn line starts close to an existing point and ends next to another existing point, it becomes a segment defined by those points.
- If the drawn line is nearly parallel or perpendicular to an existing line, segment, or side of a polygon, it aligns to that object.

**Note:** The default tolerance for detecting parallel/perpendicular lines is 12.5 degrees. This tolerance can be redefined using a variable named `ti_gg_fd.angle_tol`. You can change the tolerance in the current problem by setting this variable in the calculator app to a value in the range 0 through 45 (0=no parallel/perpendicular detection).

## Drawing Circles and Ellipses

To create a circle or ellipse, use the touchscreen or mouse to draw the approximate shape.

- If the drawn shape is sufficiently circular, a circle is created.
- If the shape is elongated, an ellipse is created.
- If the virtual center of the drawn shape is near an existing point, the circle or ellipse is centered on that point.

## Drawing Triangles

To create a triangle, draw a triangle-like shape.

- If a drawn vertex is close to an existing point, the vertex snaps to the point.

## Drawing Rectangles and Squares

To create a rectangle or square, use the touchscreen or mouse to draw the perimeter.

- If the drawn shape is nearly square, a square is created.
- If the drawn shape is elongated, a rectangle is created.
- If the center of a square is close to an existing point, the square snaps to that point.

## Drawing Polygons

To create a polygon, tap or click a succession of existing points, ending on the first point you tapped.

## Using MathDraw to Create Equations

In the Graphs view, MathDraw attempts to recognize certain gestures as functions for analytic parabolas.

**Note:** The default step value for quantization of the parabola coefficients is  $1/32$ . The denominator of this fraction can be redefined using a variable named `ti_gg_fd.par_quant`. You can change the step value in the current problem by setting this variable to a value greater or equal to 2. A value of 2, for example, produces a step value of 0.5.

## Using MathDraw to Measure an Angle

To measure the angle between two existing lines, use the touchscreen or mouse to draw a circle arc from one of the lines to the other.

- If the intersection point between the two lines does not exist, it is created and labeled.
- The angle is not a directed angle.

### **Using MathDraw to Find a Mid-point**

To create a point midway between two points, tap or click point 1, point 2, and then point 1 again.

### **Using MathDraw to Erase**

To erase objects, use the touchscreen or mouse to drag left and right, similar to the motion of erasing a whiteboard.

- The erasure area is the bounding rectangle of the erasure gesture.
- All point objects and their dependents inside the erasure area are removed.

## ***Basics of Working with Objects***

### **Selecting and Deselecting Objects**

You can select an individual object or multiple objects. Select multiple objects when you want to quickly move, color, or delete them together.

1. Click an object or graph to select it.

The object flashes to indicate selection.

2. Click any additional objects to add them to the selection.
3. Perform the operation (such as moving or setting color).
4. To deselect all objects, click an empty space in the work area.

### **Grouping and Ungrouping Geometric Objects**

Grouping objects gives you a way to reselect them as a set, even after you have deselected them to work with other objects.

1. Click each object to add it to the current selection.

The selected objects flash.

2. Display a context menu of the selected object or objects.
3. Click **Group**. You can now select all the items in the group by clicking any of its members.

- To split a group into individual objects, display a context menu of any of its member objects, and click **Ungroup**.

### Deleting Objects

- Display the context menu of the object or objects.
- Click **Delete**.

You cannot delete the origin, the axes, or points representing locked variables, even if those items are included in the selection.

### Moving Objects

You can move an object, group, or combination of selected objects and groups.

**Note:** If an immovable object (such as the graph axes or a point with locked coordinates) is included in a selection or group, you cannot move any of the objects. You must cancel the selection and then select only movable items.

To move this...	Drag this
A multiple-object selection or group	Any of its objects
A point	The point
A segment or vector	Any point other than an endpoint
A line or ray	The identifying point
A circle	The center point
Other geometric shapes	Any position on the object except one of its defining points. For example, move a polygon by dragging any of its sides.

### Constraining Object Movement

Holding down the **SHIFT** key before dragging lets you constrain how certain objects are drawn, moved, or manipulated.

Use the constraint feature to:

- Rescale only a single axis in the Graphs application.



- Pan the work area horizontally or vertically, depending on which direction you drag initially.
- Limit object movement to horizontal or vertical.
- Limit point placement to  $15^\circ$  increments as you draw a triangle, rectangle, or polygon.
- Limit angle manipulations to  $15^\circ$  increments.
- Limit the radius of a resized circle to integer values.

### Pinning Objects

Pinning objects prevents accidental changes as you move or manipulate other objects.

You can pin graphed functions, geometric objects, text objects, the graph axes, and the background.

1. Select the object or objects to pin, or click an empty area if you are pinning the background.
2. Display the context menu, and select **Pin**.

A pinned object displays a pin icon  when you point to it.

3. To unpin an object, display its context menu, and select **Unpin**.

#### Notes:

- Although you cannot drag a pinned point, you can reposition it by editing its x and y coordinates.
- You cannot pan the work area while the background is pinned.

### Changing the Line or Fill Color of an Object

Color changes made in the software are displayed in shades of gray when you work on documents using a TI-Nspire™ CX handheld that does not support color. Color is preserved when you move documents back to the software.

1. Select the object or objects.
2. Display the object's context menu, click **Color**, and then click **Line Color** or **Fill Color**.
3. Select the color to apply to the objects.

### Changing the Appearance of an Object

1. From the **Actions** menu, select **Attributes**.

2. Click the object that you want to change. You can change shapes, lines, graphs, or graph axes.

The list of the attributes for the selected object are displayed.

3. Press ▲ and ▼ to move through the list of attributes.
4. At each attribute icon, press ◀ or ▶ to move through the options. For example, select Thick, Thin, or Medium for the Line Weight attribute.
5. Press Enter to apply the changes.
6. Press ESC to close the Attributes tool.

### Labeling Points, Geometric Lines, and Shapes

1. Display the context menu of the object.
2. Click **Label**.
3. Type the text of the label, and then press **Enter**.

The label attaches itself to the object and follows the object as you move it. The label's color matches the object's color.

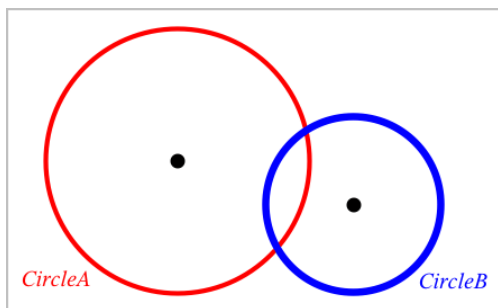

### Measuring Objects

Measurement values update automatically as you manipulate the measured object.

**Note:** Measurements of objects created in the Graphs application are displayed in generic units named *u*. Measurements of objects created in the Geometry application are displayed in centimeters (*cm*).

#### Measuring Length of a Segment, Circle Arc, or Vector

1. From the **Measurement** menu, select **Length**. (In the Graphs application, click **Geometry > Measurement > Length**.)

- Click the object to display its length.

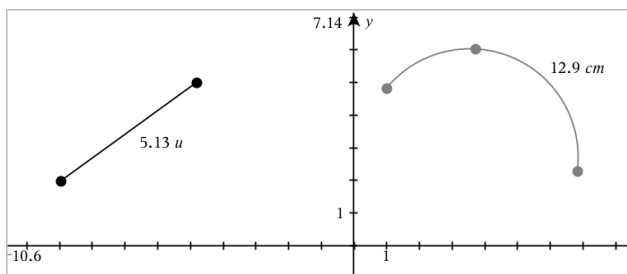

### Measuring Distance Between Two Points, a Point and a Line, or a Point and a Circle

- From the **Measurement** menu, select **Length**. (In the Graphs application, click **Geometry > Measurement > Length**.)
- Click the first point.
- Click the second point or a point on the line or circle.

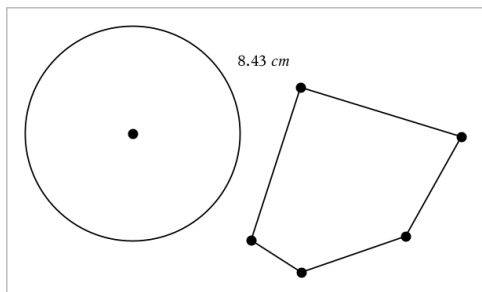

In this example, length is measured from the center of the circle to the upper left vertex of the polygon.

### Measuring Circumference of a Circle or Ellipse or the Perimeter of a Polygon, Rectangle, or Triangle

- From the **Measurement** menu, select **Length**. (In the Graphs application, click **Geometry > Measurement > Length**.)
- Click the object to display its circumference or perimeter.

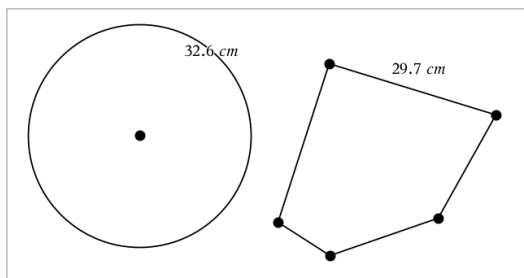

### Measuring a Side of a Triangle, Rectangle, or Polygon

1. From the **Measurement** menu, select **Length**. (In the Graphs application, click **Geometry > Measurement > Length**.)
2. Click two points on the object that form the side you want to measure.

**Note:** You must click *two points* to measure a side. Clicking the side measures the entire length of the object's perimeter.

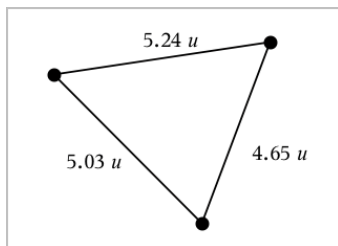

### Measuring Area of a Circle, Ellipse, Polygon, Rectangle, or Triangle

**Note:** You cannot measure the area of a polygon constructed using the Segment tool.

1. From the **Measurement** menu, select **Area**. (In the Graphs application, click **Geometry > Measurement > Area**.)
2. Click the object to display its area.

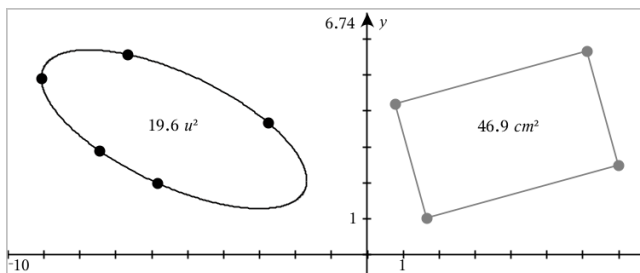

### Measuring Slope of a Line, Ray, Segment, or Vector

1. From the **Measurement** menu, select **Slope**. (In the Graphs application, click **Geometry > Measurement > Slope**.)
2. Click the object to display its slope.

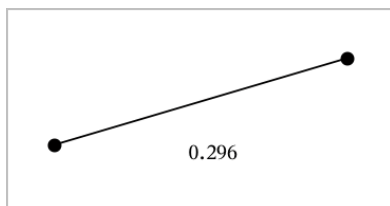

The value is updated automatically when you manipulate the object.

### Measuring Angles

Measured angles in the Geometry application range from  $0^\circ$  to  $180^\circ$ . Measured angles in the Graphs application range from 0 radians to  $\pi$  radians. To change the angle unit, use the **Settings** menu.

1. From the **Measurement** menu, select **Angle**. (In the Graphs application, click **Geometry > Measurement > Angle**.)
2. Click three locations or points to define the angle. The second click defines the vertex.

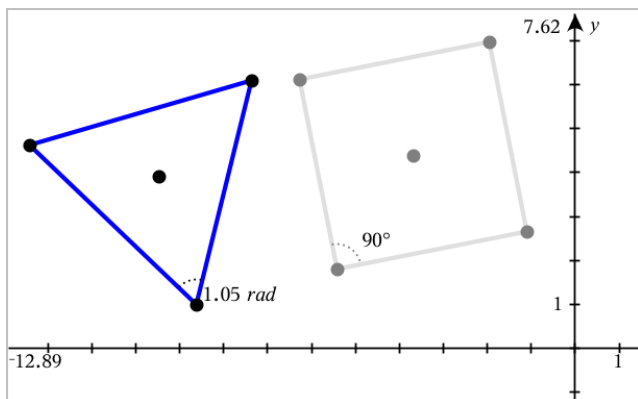

### Measuring Angles using the Directed Angle Tool

1. From the **Measurement** menu, select **Directed Angle**. (In the Graphs application, click **Geometry > Measurement > Directed Angle**.)
2. Click three locations or existing points to define the angle. The second click defines the vertex.

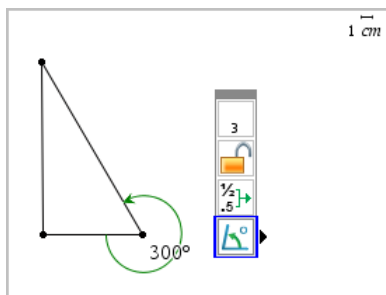

3. To reverse the measurement orientation,
  - a) On the **Actions** menu, select **Attributes**.
  - b) Click the angle text. For example, click **300°**.
  - c) Select the orientation attribute, and use the right or left arrow key to change it.
  - d) Press **Esc** to close the Attributes tool.

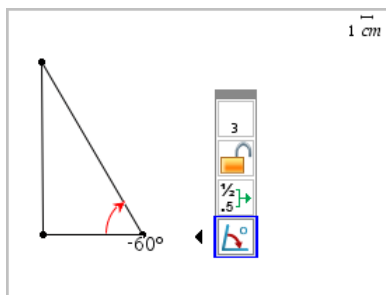

### Moving a Measured Value

- ▶ Drag the measurement to the desired location.

**Note:** If you move a measurement too far from its object, it stops following the object. However, its value continues to be updated as you manipulate the object.

### Editing a Measured Length

You can set the length of a side of a Triangle, Rectangle, or Polygon by editing its measured value.

- ▶ Double-click the measurement, and then enter the new value.

### Storing a Measured Value as a Variable

Use this method to create a variable and assign a measured value to it.

1. Display the item's context menu, and select **Store**.
2. Type a variable name for the stored measurement.

### Linking a Measured Length to an Existing Variable

Use this method to assign a measured length value to an existing variable.

1. Display the measurement's context menu, and select **Variables > Link to**.  
The menu shows the list of currently defined variables.
2. Click the name of the variable you want to link to.

### Deleting a Measurement

- ▶ Display the measurement's context menu, and select **Delete**.

## Locking or Unlocking a Measurement

1. Display the measurement's context menu, and select **Attributes**.
2. Use the up/down arrow keys to highlight the Lock attribute.
3. Use the left/right arrow keys to close or open the lock.

As long as the value remains locked, manipulations are not allowed that would require the measurement to change.

## Transforming Objects

You can apply transformations to drawn objects in both the Graphs and Geometry applications. If the object's points are labeled, the corresponding points in the transformed object are labeled using prime notation ( $A \rightarrow A'$ ). To enable automatic labeling of certain objects, see *What You Must Know* in this chapter.

### Exploring Symmetry

1. From the **Transformation** menu, select **Symmetry**. (In the Graphs application, click **Geometry > Transformation > Symmetry**.)
2. Click the object whose symmetry you want to explore.
3. Click a location or existing point to establish the point of symmetry.

A symmetrical image of the object is displayed.

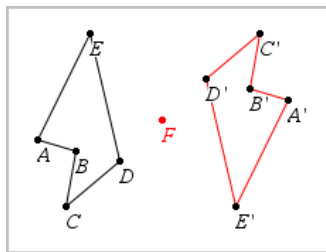

4. Manipulate the original object or the point of symmetry to explore the symmetry.

### Exploring Reflection

1. Create a line or segment to predefine the line about which the object will be reflected.
2. From the **Transformation** menu, select **Reflection**. (In the Graphs application, click **Geometry > Transformation > Reflection**.)
3. Click the object whose reflection you want to explore.



- Click the predefined reflection line or segment.

A reflected image of the object is displayed.

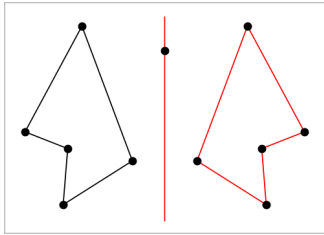

- Manipulate the original object or the line of symmetry to explore the reflection.

### Exploring Translation

- (Optional) Create a vector to predefine the distance and direction of translation.
- From the **Transformation** menu, select **Translation**. (In the Graphs application, click **Geometry > Transformation > Translation**.)
- Click the object whose translation you want to explore.
- Click the predefined vector.

—or—

Click two locations on the work area to indicate the direction and distance of translation.

A translated image of the object is displayed.

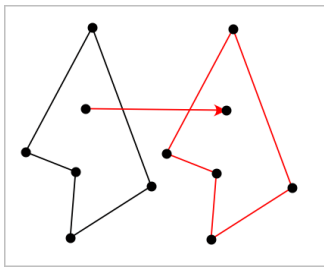

- Manipulate the original object or the vector to explore the translation.

### Exploring Rotation

- (Optional) Create an angle measurement to serve as a predefined angle of rotation.

- From the **Transformation** menu, select **Rotation**. (In the Graphs application, click **Geometry > Transformation > Rotation**.)
- Click the object whose rotation you want to explore.
- Click a location or point to define the point of rotation.
- Click the points of the predefined angle.  
—or—  
Click three locations to define an angle of rotation.

A rotated image of the object is displayed.

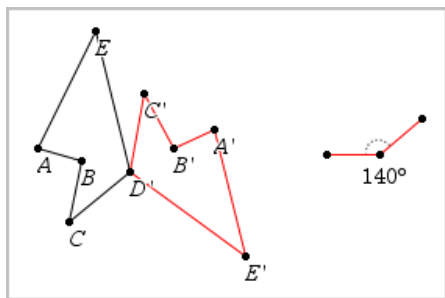

- Manipulate the original object or the point of rotation to explore the rotation.

### Exploring Dilation

- Create a Text object containing a numeric value to serve as a predefined dilation factor.

**Note:** You can also use a measured length value as the dilation factor. Keep in mind that if you use a large value, you may have to pan the display to view the dilated object.

- From the **Transformation** menu, select **Dilation**. (In the Graphs application, click **Geometry > Transformation > Dilation**.)
- Click the object whose dilation you want to explore.
- Click a location or existing point to define the center point of dilation.
- Click the Text object or measurement that defines the dilation factor.

A dilated image of the object is displayed.

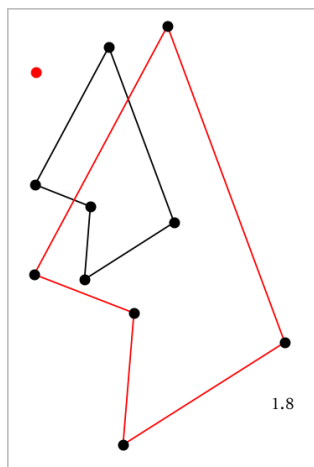

6. Manipulate the original object or the center point of dilation to explore the dilation. You can also edit the dilation factor.

### ***Exploring with Geometric Construction Tools***

While a construction is in progress, a tool appears in the work area (for example, **Parallel** ) . To cancel, press **ESC**.

#### **Creating a Midpoint**

This tool lets you bisect a segment or define a midpoint between any two points. The points can be on a single object, on separate objects, or on the work area.

1. From the **Construction** menu, select **Midpoint**. (In the Graphs application, click **Geometry > Construction > Midpoint**.)
2. Click a point or location to define the first point.
3. Click a second point or location to complete the midpoint.

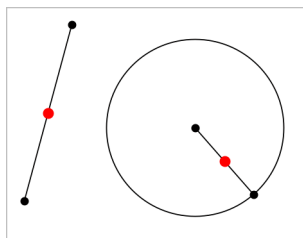

## Creating a Parallel Line

This tool creates a parallel line with respect to any existing line. The existing line can be a Graphs axis or any side of a triangle, square, rectangle, or polygon.

1. From the **Construction** menu, select **Parallel**. (In the Graphs application, click **Geometry > Construction > Parallel**.)
2. Click the object that will serve as the reference line.
3. Click a location to create the parallel line.

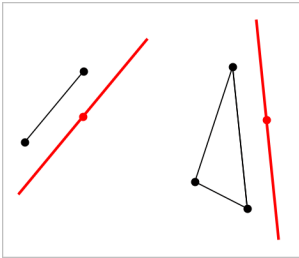

You can drag the parallel line to move it. If you manipulate the reference object, the line remains parallel.

## Creating a Perpendicular Line

You can create a line that is perpendicular to a reference line. The reference can be an axis, an existing line, a segment, or one side of a triangle, rectangle, or polygon.

1. From the **Construction** menu, select **Perpendicular**. (In the Graphs application, click **Geometry > Construction > Perpendicular**.)
2. Click a location or existing point through which the perpendicular line should pass.
3. Click the item that will serve as the reference line.

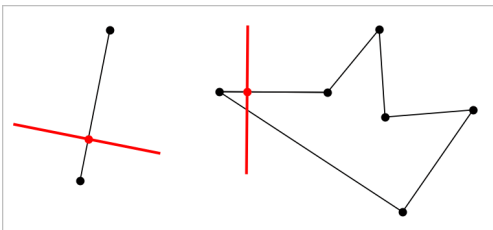

You can drag the intersection point to move the perpendicular. If you manipulate the reference object, the line remains perpendicular.

## Creating a Perpendicular Bisector

You can create a perpendicular bisector on a segment, on one side of a triangle, rectangle, or polygon, or between any two points.

1. From the **Construction** menu, select **Perpendicular Bisector**. (In the Graphs application, click **Geometry > Construction > Perpendicular Bisector**.)
2. Click the item that will serve as the reference line.  
—or—  
Click two points to create a perpendicular bisector between them.

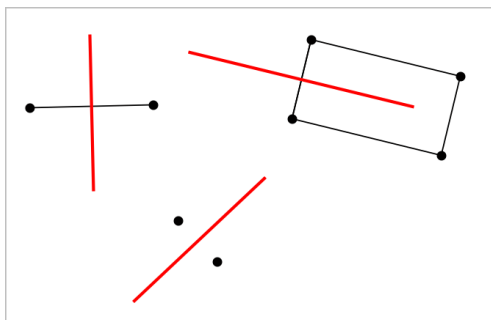

## Bisecting an Angle

This tool creates an angle bisector. The points of the angle can be on existing objects, or they can be locations on the work area.

1. From the **Construction** menu, select **Angle Bisector**. (In the Graphs application, click **Geometry > Construction > Angle Bisector**.)
2. Click three locations or points to define the angle. The second click defines the vertex of the angle.

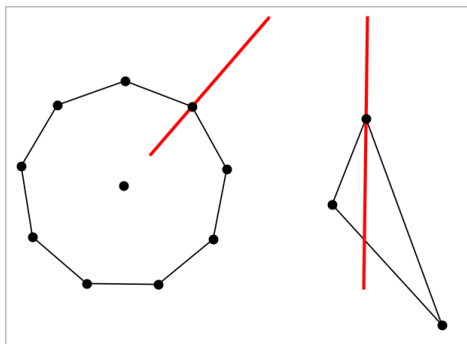

The angle bisector adjusts automatically as you manipulate its defining points.

### Creating a Locus

The Locus tool enables you to explore the range of motion of one object with respect to another object as constrained by a shared point.

1. Create a segment, line, or circle.
2. Create a point on the segment, line, or circle.

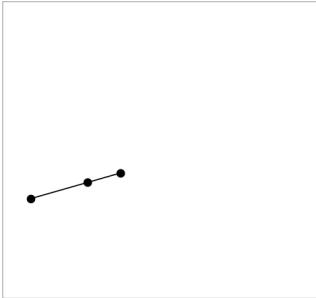

3. Create another object that uses the point created in the previous step.

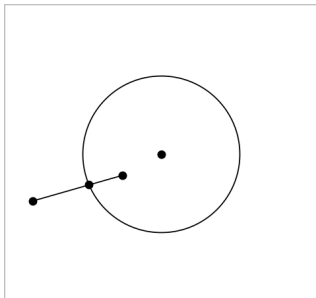

*Circle created to use the defined point on the segment.*

4. From the **Construction** menu, select **Locus**. (In the Graphs application, click **Geometry > Construction > Locus**.)
5. Click the point shared by the objects.
6. Click the object defined to share the point (this is the object to vary).

The continuous locus is displayed.

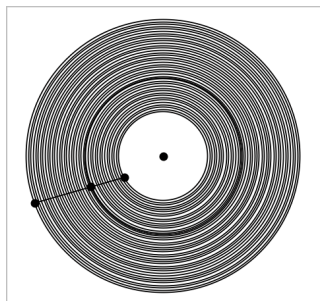

### Creating a Compass

This tool operates similarly to a geometric compass used for drawing circles on paper.

1. From the **Construction** menu, select **Compass**. (In the Graphs application, click **Geometry > Construction > Compass**.)
2. To set the width (radius) of the compass:

Click a segment.

—or—

Click any side of a triangle, rectangle, polygon, or regular polygon.

—or—

Click any two existing points or locations on the work area.

3. Click a location to establish the center of the circle and complete the construction.

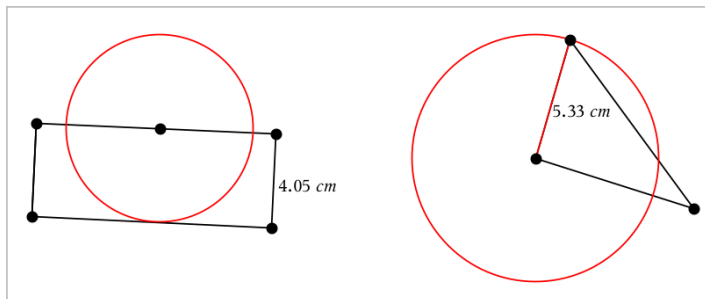



The radius adjusts automatically as you manipulate the original segment, side, or points used to define the radius.



### Animating Points on Objects

You can animate any point created as a point on an object or graph. Multiple points can be animated simultaneously.

## Animating a Point

1. From the **Actions** menu, select **Attributes**.
2. Click the point to display its attributes.
3. Press ▼ to select the animation attributes.
4. Press ◀ or ▶ to choose either unidirectional or alternating animation.
5. Type a value to set the animation speed. Any nonzero speed begins the animation. To reverse the direction, enter a negative value.
6. Press **Enter** to display the animation controls  .
7. Press **ESC** to close the Attributes tool.

## Pausing and Resuming All Animations

- ▶ To pause all animations on a page, click **Pause** .
- ▶ To resume all animations, click **Play** .

## Resetting All Animations

Resetting pauses all animations and returns all animated points to the positions they occupied when they were first animated.

- ▶ To reset animation, click **Reset** .

## Changing or Stopping the Animation of a Point

1. Click **Reset**  to stop all animation.
2. From the **Actions** menu, select **Attributes**.
3. Click the point to display its attributes.
4. Select the animation attribute, and type a new animation speed. To stop the point's animation, enter zero.

**Note:** If other animated points exist, the animation controls remain in the work area.

## Adjusting Variable Values with a Slider

A slider control lets you interactively adjust or animate the value of a numeric variable. You can insert sliders in the Graphs, Geometry, Notes, and Data & Statistics applications.



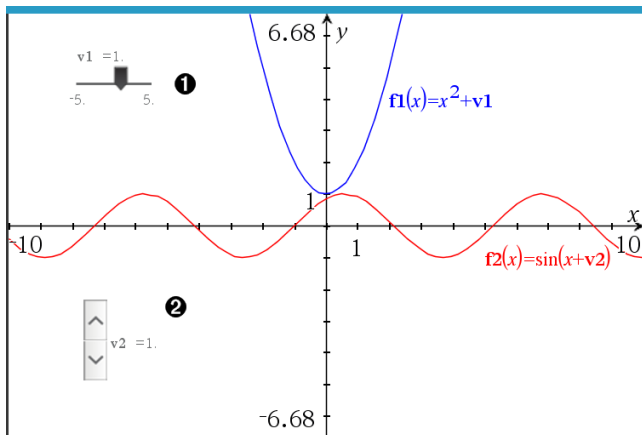

- ❶ Horizontal slider for adjusting variable  $v1$ .
- ❷ Minimized vertical slider for adjusting variable  $v2$ .

**Note:** TI-Nspire™ version 4.2 or higher is required for opening .tns files containing sliders on Notes pages.

### Inserting a Slider Manually

1. From a Graphs, Geometry, or Data & Statistics page, select **Actions > Insert Slider**.  
—Or—  
From a Notes page, make sure the cursor is not in a math box or chem box, and then select **Insert > Insert Slider**.

The Slider Settings screen opens.

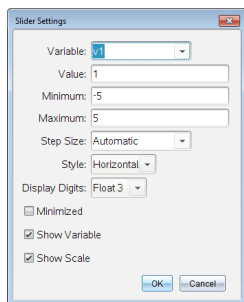

2. Enter the desired values, and click **OK**.

The slider is displayed. On a Graphs, Geometry, or Data & Statistics page, handles are displayed to let you move or stretch the slider.

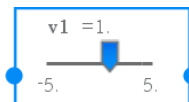

To remove the handles and use the slider, click an empty space in the work area. You can show the handles anytime by selecting **Move** from the slider's context menu.

- To adjust the variable, slide the pointer (or click the arrows on a minimized slider).
  - You can use the **Tab** key to move the focus to a slider or to move from one slider to the next. The color of the slider changes to show you when it has the focus.
  - When a slider has the focus, you can use the arrow keys to change the value of the variable.

### Working with the Slider

Use the options on the context menu to move or delete the slider, and to start or stop its animation. You can also change the slider's settings.

- Display the slider's context menu.

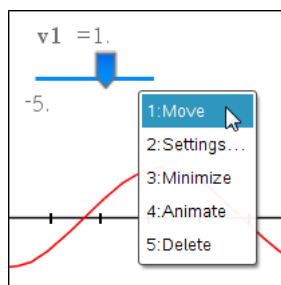

- Click an option to select it.

### Automatic Sliders in Graphs

Sliders can be created for you automatically in the Graphs application and in the analytic window of the Geometry application. You are offered automatic sliders when you define certain functions, equations, or sequences that refer to undefined variables.

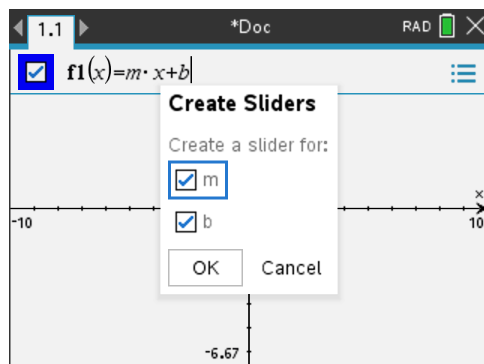

## Labeling (Identifying) the Coordinates of a Point

The Graphs application can identify and label the coordinates of any existing point, provided the point was created in the Graphs application.

1. From the **Actions** menu, select **Coordinates and Equations**.

The tool appears at the top of the work area

2. Tap the point whose coordinates you want to show.

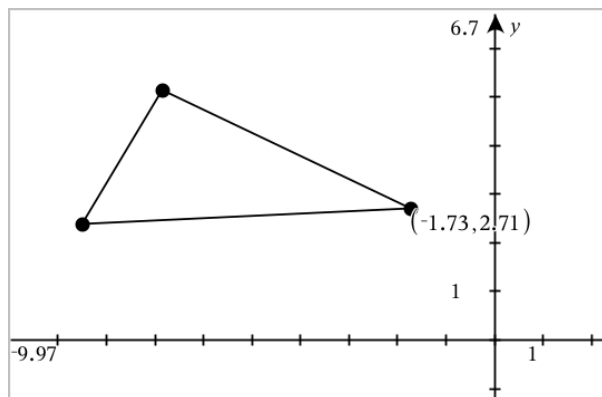

3. Press **Esc** to close the tool.

If you later move the point to a different location, the coordinates follow the point and update automatically.

## Displaying the Equation of a Geometric Object

You can display the equation of a line, tangent line, circle shape, or geometric conic, provided the object was constructed in the Graphing View or within the Analytic Window of the Plane Geometry View.

**Note:** Due to differences in the numerical representations of analytic and geometric conics, the capability to convert a geometric conic to an analytic template may sometimes be unavailable. This is done in order to avoid a situation where the template-based conic would be different from the geometric one.

1. From the **Actions** menu, click **Coordinates and Equations**.
2. Move the pointer to the object.

The equation for the object appears.

**Note:** If you approach a defined point on the line or the center point of a circle, the coordinates of that point are displayed instead of the equation. Move the pointer away from the defined point to obtain the equation of the object.

3. Click to attach the equation to the pointer.

- Move the equation to the desired location, and click to anchor it.

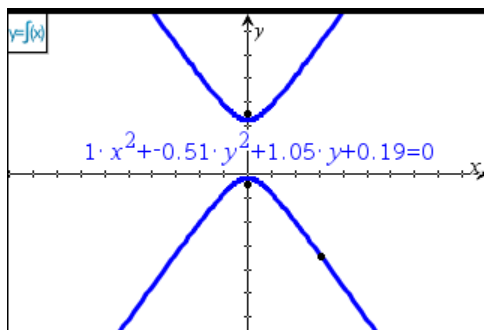

- Press **Esc** to exit the tool.

### ***Using the Calculate Tool***

The Calculate tool is available in the Graphs and Geometry applications. It lets you evaluate a math expression you have entered as a text object.

The following example uses the Calculate tool to sum the measured angles of a triangle.

- Using the **Shapes** menu, create a triangle, and then measure its angles.

**Tip:** You can enable options to automatically label points and to force geometric triangle angles to integers. For more information, see *What You Must Know*, in this chapter.

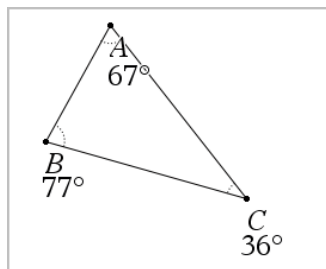

- From the **Actions** menu, click **Text**.
- Click a location for the text, and type the formula for the calculation.

In this example, the formula sums three terms.

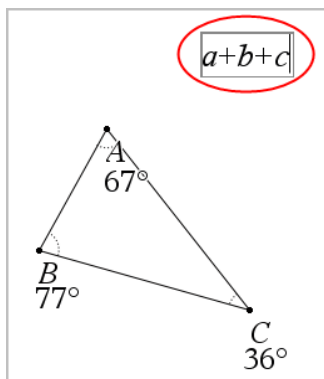

4. From the **Actions** menu, click **Calculate**.
5. Click the formula you created.

You are prompted to select a value for each term in the formula.

6. Click each angle measurement when prompted.

**Note:** If you have stored a measurement as a variable, you can select it when prompted by clicking . If the name of a stored measurement matches a term in the formula, you can press "L" when prompted for that term.

After you have selected the third term, the calculation result attaches itself to the pointer.

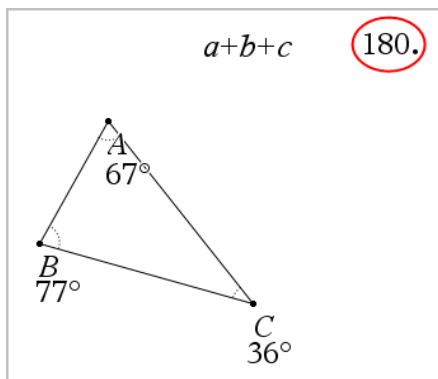



7. Position the result, and press **Enter** to anchor it as a new text object.

## 3D Graphs

The 3D Graphing view lets you create and explore three-dimensional graphs of:

- 3D functions of the form  $z(x,y)$
- 3D parametric plots

### Selecting the 3D Graphing View

The 3D Graphing View is available on any Graphs page  or Geometry page .

- From the **View** menu, select **3D Graphing**.

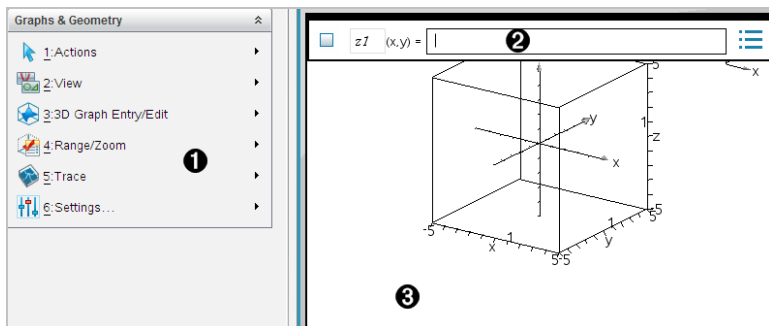

- 1 3D Graphs Menu**
- 2 Entry line.** Lets you define 3D graphs. The default graph type is 3D Function, indicated by  $z1(x,y)=$ .
- 3 3D Graphs Work Area.** Shows a 3D box containing graphs that you define. Drag to rotate the box.

### Graphing 3D Functions

1. In the 3D Graphing view, select **3D Graph Entry/Edit > Function**.

The entry line appears.

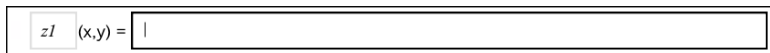

2. Enter the expression that defines the graph. You can type the expression or build it using expression templates.

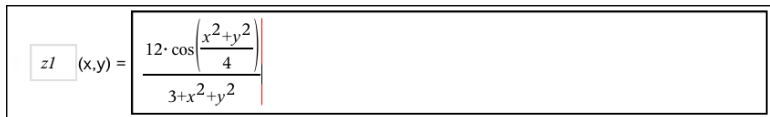

- Press **Enter** to create the graph and hide the entry line. You can show or hide the entry line anytime by pressing **Ctrl+G**.

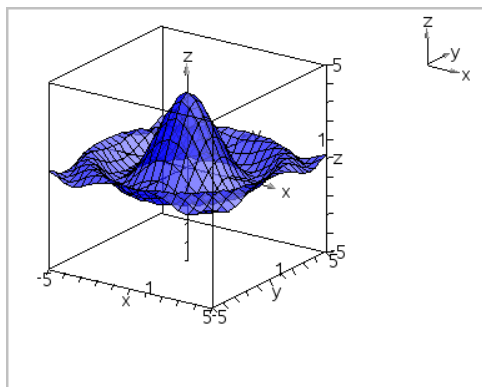

### Graphing 3D Parametric Equations

- In the 3D Graphing view, select **3D Graph Entry/Edit > Parametric**.

The entry line appears.

$xp1$	(t,u) =		
$yp1$	(t,u) =	<Enter expression>	...
$zp1$	(t,u) =	<Enter expression>	

- Type the equations that define the graph.

$xp1$	(t,u) =	$4 \cdot \cos(t) - \sin(u) \cdot \cos(t)$	
$yp1$	(t,u) =	$4 \cdot \sin(t) - \sin(u) \cdot \sin(t)$	...
$zp1$	(t,u) =	$\cos(u)$	

- Press **Enter** to draw the graph and hide the entry line and keyboard. You can show or hide the entry line anytime by pressing **Ctrl+G**.

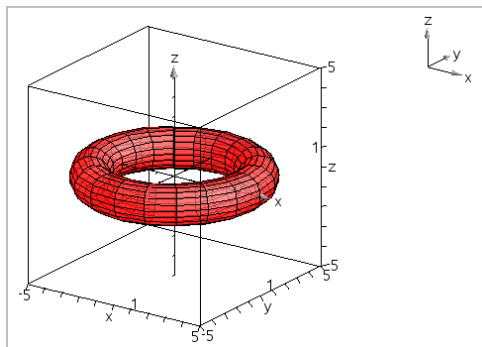

- To set the graphing parameters  $tmin$ ,  $tmax$ ,  $umin$ , and  $umax$ , display the graph's context menu, and select **Edit Parameters**.

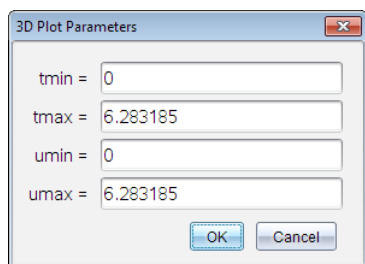

## Rotating the 3D View

### Rotating Manually

- Press **R** to activate the Rotation tool.
- Press any of the four arrow keys to rotate the graph.

### Rotating Automatically

Auto rotation is equivalent to holding down the right arrow key.

- Press **A**.

The Auto Rotation icon  appears, and the graph rotates.

- (Optional) Use the up and down arrow keys to explore the rotating graph.
- To stop the rotation and return to the Pointer tool, press **Esc**.

### Viewing from Specific Orientations

- If necessary, press **Esc** to return to the Pointer tool.
- Use letter keys to select the orientation:
  - Press **Z**, **Y**, or **X** to view along the z, y, or x axis.
  - Press letter **O** to view from the default orientation.



## Editing a 3D Graph

1. Double-click the graph to show its expression in the entry line.  
—or—  
Display the graph's context menu, and then click **Edit Relation**.

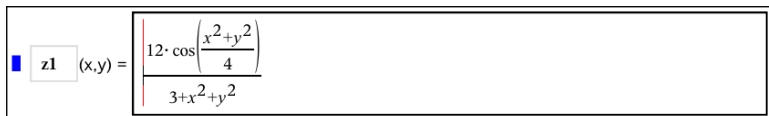

2. Modify the existing expression, or type a new expression in the entry line.
3. Press **Enter**.

## Accessing the Graph History

For each problem, the software stores a history of relations defined in the Graphs application and 3D Graphing view, such as function graphs **f1** through **f99** and 3D function graphs **z1** through **z99**. You can view and edit these items using a button on the entry line.

### Viewing the History

1. Press **Ctrl+G** to show the entry line.
2. Click the **History Menu** button  on the entry line.

The menu is displayed. As you point to the name of each item, its expression appears in the entry line.

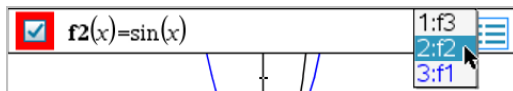

3. Select the name of the relation you want to view or edit.
4. (Optional) From the entry line, use the up and down arrow keys to scroll through the defined relations of the same type.

### Viewing the History of Specific Relation Types

Use this method if you want to view or edit a defined relation that does not appear in the History menu.

1. On the **Graph Entry/Edit** menu, click the relation type. For example, click **Polar** to show the entry line for the next available Polar relation.
2. Click the **History Menu** button , or use the up and down arrow keys to scroll through the defined relations of the same type.

## Changing the Appearance of a 3D Graph

### Setting Wire and Surface Color:

1. Display the graph's context menu, click **Color**, and then click **Line Color** or **Fill Color**.
2. Click a color swatch to apply it.

### Setting Custom Plot Colors:

You can assign different colors to a graph's top and bottom surfaces or choose to have the graph colored automatically, based on height or steepness. You can also set the wire color.

1. Display the graph's context menu, and then click **Color > Custom Plot Color**.

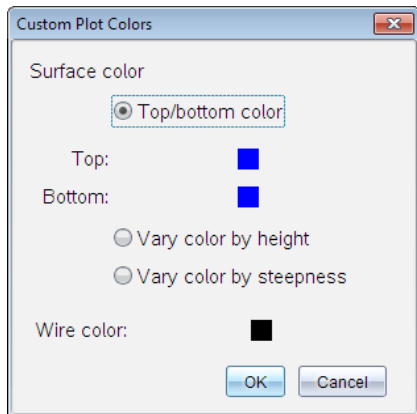

2. Select one of the three Surface color options: **Top/bottom color**, **Vary color by height**, or **Vary color by steepness**.
  - If you choose Top/bottom color, click the color swatches to select colors for the top and bottom surfaces.
  - If you choose to vary color by height or steepness, colors are determined automatically.
3. To set the Wire color, click the color swatch and select a color.

### Setting Other Attributes of a Graph:

1. Display the graph's context menu, and then click **Attributes**. You can set the following attributes for the selected graph.
  - format: surface+wire, surface only, or wire only

- x resolution (enter a value in range 2-200\*, default=21)
- y resolution (enter a value in range 2-200\*, default=21)
- transparency (enter a value in range 0-100, default=30)

\* Handhelds are limited to a maximum display resolution of 21, regardless of the value entered.

2. Set the attributes as you like, and then press **Enter** to accept the changes.

### **Showing or Hiding a Graph's Label**

- ▶ Display the graph's context menu, and then click **Hide Label** or **Show Label**.

### **Showing and Hiding 3D Graphs**

1. In the 3D Graphing view, select **Actions > Hide/Show**.

The Hide/Show tool  appears, and all hidden items are displayed in gray.

2. Tap a graph to change its hide/show state.
3. To apply the changes and dismiss the tool, press **Esc**.

**Note:** If you want to show or hide only the graph's label, see [Showing or Hiding a Graph's Label](#).

### **Customizing the 3D Viewing Environment**

#### **Setting the Background Color**

- ▶ Display the context menu for the work area, and then click **Background Color**.

#### **Showing or Hiding Specific View Elements**

- ▶ From the **View** menu, click the item to show or hide. You can choose items such as the 3D box, axes, box end values, and legend.

#### **Changing the 3D Projection**

- ▶ From the **View** menu, click **Orthographic Projection** or **Perspective View**.

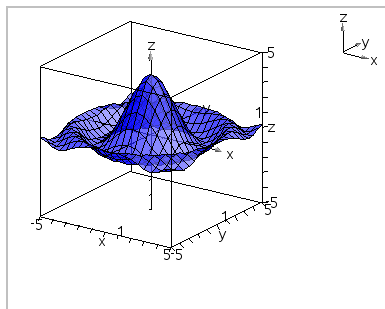

*Orthographic Projection  
(default)*

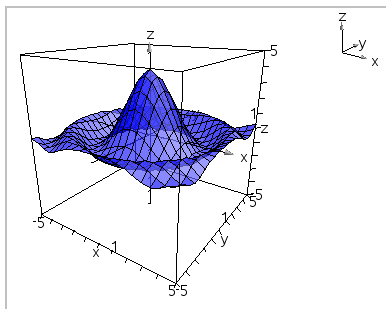

*Perspective View*

### Setting the Visual Attributes of the Box and Axes

1. Display the context menu for the box, and then click **Attributes**. You can set the following attributes.
  - Show or hide tic labels
  - Show or hide end values
  - Show or hide arrows on axes
  - Show 3D or 2D arrow heads
2. Set the attributes as you like, and then press **Enter** to accept the changes.

### Shrinking or Magnifying the 3D View

- From the **Range/Zoom** menu, click **Shrink Box** or **Magnify Box**.

### Changing the 3D Aspect Ratio

1. From the **Range/Zoom** menu, click **Aspect Ratio**.
2. Enter values for the x, y, and z axes. The default value for each axis is **1**.

### Changing the Range Settings

- On the **Range/Zoom** menu, click **Range Settings**. You can set the following parameters.
  - XMin (default=-5)
  - XMax (default=5)
  - XScale (default=Auto) You can enter a numeric value.

- YMin (default=-5)  
YMax (default=5)  
YScale (default=Auto) You can enter a numeric value.
- ZMin (default=-5)  
ZMax (default=5)  
ZScale (default=Auto) You can enter a numeric value.
- eye  $\theta^\circ$  (default=35)  
eye  $\phi^\circ$  (default=160)  
eye distance (default=11)

### Tracing in the 3D View

1. From the **Trace** menu, select **z Trace**.

The z Trace icon  and the trace plane appear, along with a text line showing the current "z=" trace value.

2. To move the trace, hold down **Shift** and press the up or down arrow key.

The "z=" text is updated as you move.

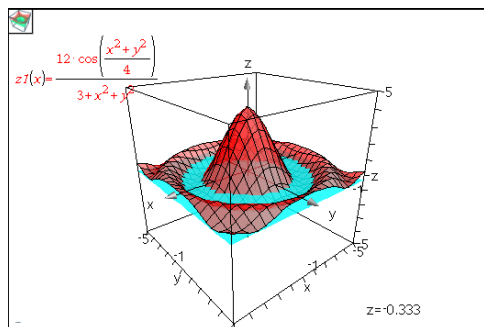

3. (Optional) Use the four arrow keys to rotate the view and see how the trace plane and the graph intersect.
4. To stop tracing and return to the Pointer tool, press **Esc**.

### Changing the Trace Settings

1. From the **Trace** menu, select **Trace Setup**.

The 3D Trace Setup dialog box opens.

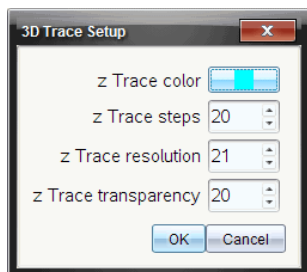

2. Enter or select the settings, and click **OK** to apply them.
3. If you are not already tracing, your new settings take effect the next time you trace.

### **Example: Creating an Animated 3D Graph**

1. Insert a new problem and select the 3D Graphing view.
2. From the **Actions** menu, select **Insert Slider**, click to position it, and type **time** as the variable name.
3. Display the slider's context menu, click **Settings**, and enter the following values.

Value: **3.8**

Minimum: **3.2**

Maximum: **4.4**

Step Size: **0.1**

4. In the entry line, define the function shown here:

A software interface showing a function definition. On the left is a red square icon. To its right is a text box containing "z1". Further right is the equation  $(x,y) = 3 + \frac{|\sin(\text{time})|}{x^2 + y^2}$ . A blue circular icon is visible to the right of the equation.

5. Drag the slider thumb to see the effect of varying *time*.

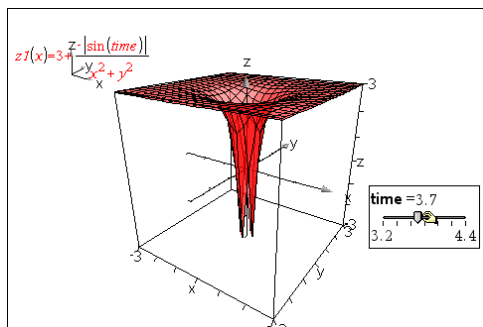

6. Add visual interest. For example:
  - [Change the background color](#) of the work area.

- [Hide the box, axes, or legend.](#)
- [Automatically rotate](#) the graph.
- [Change the graph's fill color and hide its lines.](#)
- Change the graph's [transparency and shading.](#)

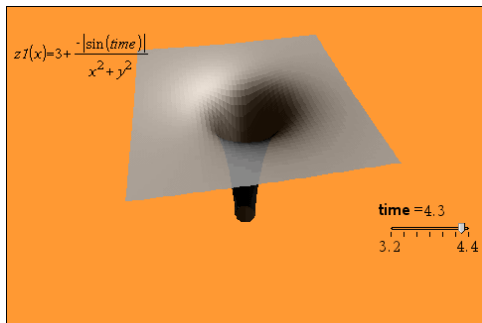

7. To animate the graph, display the slider's context menu, and click **Animate**. (To stop, click **Stop Animate** from the context menu.)

You can combine manual or auto rotation with the slider animation. Experiment with the x and y resolution to balance curve definition against animation smoothness.

# Geometry Application



The Geometry application lets you:

- Create and explore geometric objects and constructions.
- Manipulate and measure geometric objects.
- Animate points on objects and explore their behavior.
- Explore object transformations.

## Adding a Geometry Page

- ▶ To start a new document with a blank Geometry page:

From the main **File** menu, click **New Document**, and then click **Add Geometry**.

Handheld: Press , and select **Geometry** .

- ▶ To add a Geometry page in the current problem of an existing document:

From the toolbar, click **Insert > Geometry**.

Handheld: Press  and select **Insert > Geometry**.

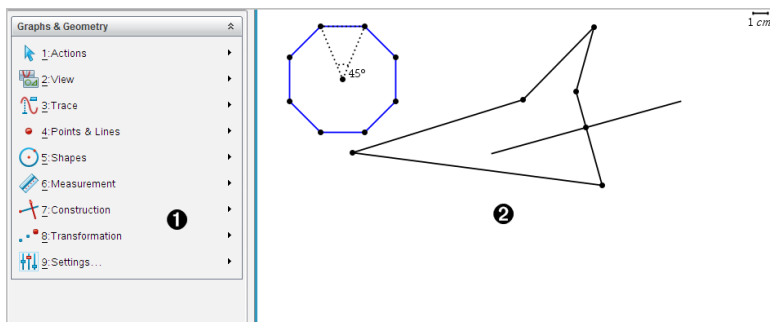

- 1 Geometry menu – Available anytime you are viewing a Geometry page.
- 2 Geometry work area – The drawing area where you create and explore geometric objects.

## What You Must Know

### Changing the Graphs and Geometry Settings

1. From the **Settings** menu in the Documents Toolbox, select **Settings**.
2. Select the settings that you want to use.
  - **Display Digits**. Sets the display format for numbers as Floating or Fixed decimal.





- **Graphing Angle.** Sets the angle unit for all Graphs and 3D Graphing applications in the current document. The default setting is Radian. Set this to Auto if you want graphing angles to follow the Angle setting in the main **File > Settings** menu. An angle mode indicator shows the resulting mode in Graphs and 3D Graphing applications.
- **Geometry Angle.** Sets the angle unit for all Geometry applications in the current document. The default setting is Degree. Set this to Auto if you want geometry angles to follow the Angle setting in the main **File > Settings** menu. An angle mode indicator shows the resulting mode in Geometry applications.
- **Grid.** Sets the grid display in the Graphs application. The default setting is No Grid. Dot Grid and Lined Grid are also available.
- **Automatically hide plot labels.** In the Graphs application, hides the label that normally appears next to a graphed relation.
- **Show axis end values.** Applies only in the Graphs application.
- **Show tool tips for function manipulation.** Applies only in the Graphs application.
- **Automatically find points of interest.** In the Graphs application, shows zeros, minima, and maxima while tracing function graphs.
- **Force Geometric Triangle Angles to Integers.** Restricts the angles of a triangle to integer values as you create or edit the triangle. This setting applies only in the Geometry View with the Geometry Angle unit set to Degree or Gradian. It does not apply to analytic triangles in Graphing View or to analytic triangles in the Analytic Window of the Geometry View. This setting does not affect existing angles, and it does not apply when constructing a triangle based on previously inserted points. By default, this setting is deselected.
- **Automatically Label Points.** Applies labels ( $A$ ,  $B$ , ...,  $Z$ ,  $A_1$ ,  $B_1$ , and so on) to points, lines, and vertices of geometric shapes as you draw them. The labeling sequence starts at  $A$  for each page in a document. By default, this setting is deselected.

**Note:** If you create a new object that uses existing unlabeled points, those point are not automatically labeled in the completed object.

- Click **Restore** to restore all settings to their factory defaults.
- Click **Make Default** to apply the current settings to the open document and save them as the default for new Graphs and Geometry documents.

## Using Context Menus

Context menus provide quick access to commonly used commands and tools that apply to a specific object. For example, you can use a context menu to change an object's line color or to group a set of selected objects.

- ▶ Display the context menu for an object in one of the following ways.
  - Windows®: Right-click the object.
  - Mac®: Hold  and click the object.
  - Handheld: Move the pointer to the object, and then press  .

## Finding Hidden Objects in the Graphs or Geometry Application

You can hide and show individual graphs, geometric objects, text, labels, measurements, and axis end-values.

To temporarily view hidden graphs or objects or to restore them as shown objects:

1. From the **Actions** menu, select **Hide/Show**.

The Hide/Show tool  appears in the work area, and all hidden objects become visible in dimmed colors.

2. Click a graph or object to toggle its Hide/Show state.
3. To apply the changes and close the Hide/Show tool, press **ESC**.

## Inserting a Background Image

You can insert an image as a background for a Graphs or Geometry page. The file format of the image can be .bmp, .jpg, or .png.

1. From the **Insert** menu, click **Image**.
2. Navigate to the image you want to insert, select it, and then click **Open**.

For information on moving, resizing, and deleting a background image, see [Working with Images in the Software](#).

## Adding Text to the Graphs or Geometry Work Area

1. From the **Actions** menu, select **Text**.

The Text tool  appears in the work area.

2. Click the location for the text.

3. Type the text in the box that appears, and then press **Enter**.

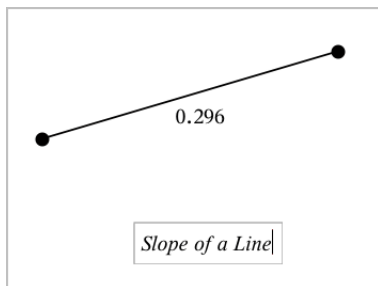

4. To close the Text tool, press **ESC**.
5. To edit the text, double-click it.

### **Deleting a Relation and its Graph**

1. Select the relation by clicking its graph.
2. Press **Backspace** or **DEL**.

The graph is removed from both the work area and the graph history.

## ***Introduction to Geometric Objects***

Geometry tools are accessible in both the Graphs and Geometry applications. You can use these tools to draw and investigate objects such as points, lines, and shapes.

- The Graphing view shows the Graphs work area superimposed on the Geometry work area. You can select, measure, and alter objects in both work areas.
- The Plane Geometry view shows only the objects created in the Geometry application.

### **Objects Created in the Graphs Application**

Points, lines, and shapes created in the Graphs application are analytic objects.

- All points that define these objects reside on the  $x,y$  graph plane. Objects created here are visible only in the Graphs application. Changing the axes scale affects the appearance of the objects.
- You can display and edit the coordinates of any point on an object.
- You can display the equation of a line, tangent line, circle shape, or geometric conic created in the Graphs application.

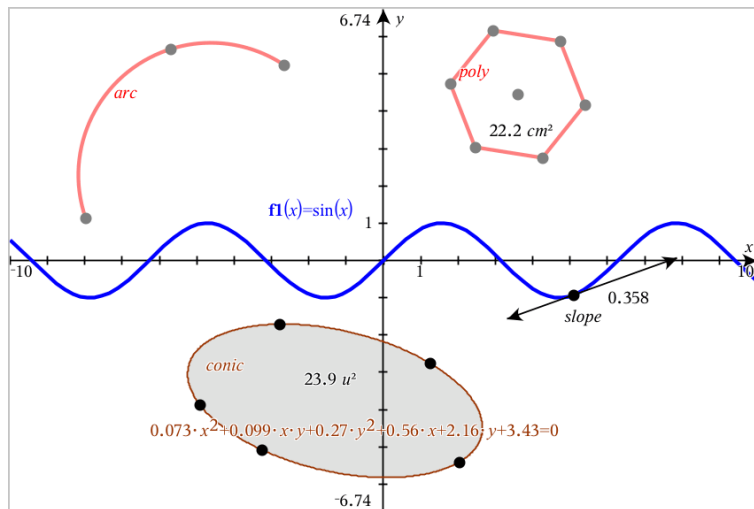

The circle arc and polygon were created in the Geometry application. The sine wave and conic were created in the Graphs application.

### Objects Created in the Geometry Application

Points, lines, and shapes created in the Geometry application are not analytic objects.

- Points that define these objects do not reside on the graph plane. Objects created here are visible in both the Graphs and Geometry applications, but they are unaffected by changes to the Graphs x,y axes.
- You cannot obtain the coordinates of an object's points.
- You cannot display the equation of a geometric object created in the Geometry application

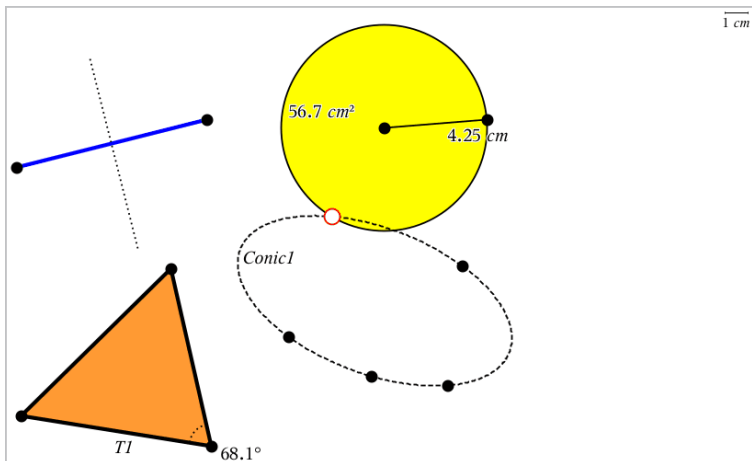

## Creating Points and Lines

As you create an object, a tool appears in the work area (for example, **Segment** ). To cancel, press **ESC**. To enable automatic labeling of certain objects, see *What You Must Know* in this chapter.

### Creating a Point on the Work Area

1. From the **Points and Lines** menu, select **Point**. (In the Graphs application, click **Geometry > Points and Lines > Point**.)
2. Click a location to create the point.
3. (Optional) Label the point.
4. To move a point, drag it.

### Creating a Point on a Graph or Object

You can create a point on a line, segment, ray, axis, vector, circle, graph, or axis.

1. From the **Points and Lines** menu, select **Point On**. (In the Graphs application, click **Geometry > Points and Lines > Point On**.)
2. Click the graph or object on which you want to create the point.
3. Click a location on the object to place the point.

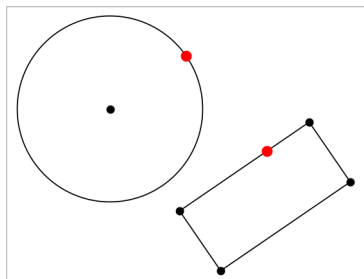

## Creating a Dynamic Point on a Graph

You can create a dynamic point on a graph with Point by Coordinates.

1. From the **Points and Lines** menu, select **Point by Coordinates**. (In the Graphs application, click **Geometry > Points and Lines > Point by Coordinates** or press **P** and select **Point by Coordinates**).

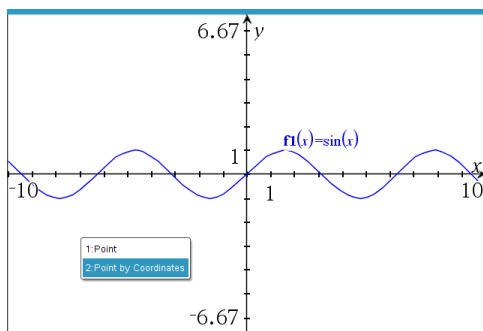

2. Enter the variables or expressions for one or both of the coordinates.

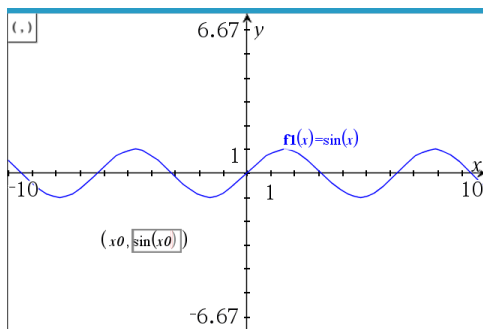

3. Use the slider that is created to move the point on the graph.

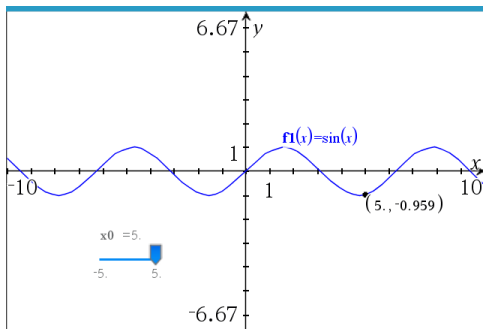

The point will display the actual coordinates. If you hover the cursor over a coordinate, it will display the variable or expression.

To edit the point, double-click the coordinate on the label. Any variable or expression that was entered before is retained.

### Identifying Points of Intersection

1. From the **Points and Lines** menu, select **Intersection Points**. (In the Graphs application, click **Geometry > Points and Lines > Intersection Points**.)
2. Click two intersecting objects to add points at their intersections.

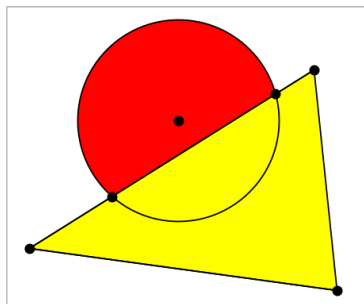

### Creating a Line

1. From the **Points and Lines** menu, select **Line**. (In the Graphs application, click **Geometry > Points and Lines > Line**.)
2. Click a location to define one point on the line.
3. Click a second location to define the direction of the line and the length of its visible portion.

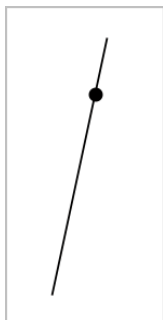

4. To move a line, drag its identifying point. To rotate it, drag any point except the identifying point or ends. To extend its visible portion, drag from either end.

### Creating a Segment

1. From the **Points and Lines** menu, select **Segment**. (In the Graphs application, click **Geometry > Points and Lines > Segment**.)
2. Click two locations to define the endpoints of the segment.

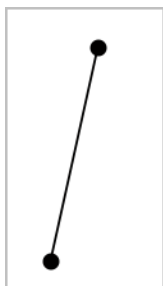

3. To move a segment, drag any point other than an endpoint. To manipulate the direction or length, drag either endpoint.

### Creating a Ray

1. From the **Points and Lines** menu, select **Ray**. (In the Graphs application, click **Geometry > Points and Lines > Ray**.)
2. Click a location to define the endpoint of the ray.
3. Click a second location to define the direction.



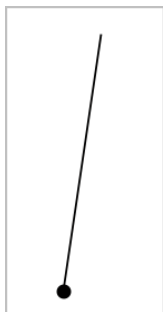

To move a ray, drag its identifying point. To rotate it, drag any point except the identifying point or end. To extend its visible portion, drag from the end.

### Creating a Tangent

You can create a tangent line at a specific point on a geometric object or function graph.

1. From the **Points and Lines** menu, select **Tangent**. (In the Graphs application, click **Geometry > Points and Lines > Tangent**.)
2. Click the object to select it.
3. Click a location on the object to create the tangent.

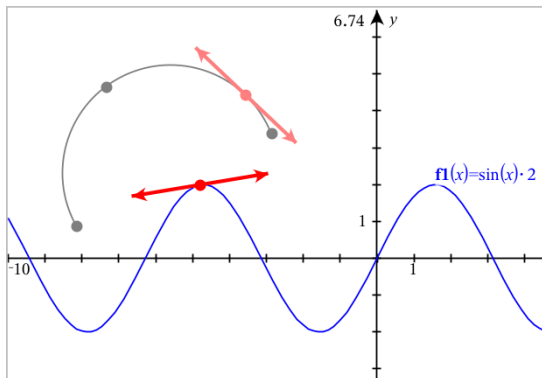

4. To move a tangent, drag it. It remains attached to the object or graph.

### Creating a Vector

1. From the **Points and Lines** menu, select **Vector**. (In the Graphs application, click **Geometry > Points and Lines > Vector**.)

- Click a location to establish the vector's initial point.
- Click a second location to specify direction and magnitude and complete the vector.

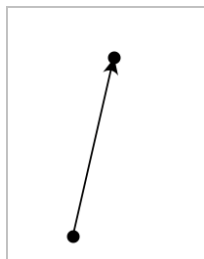

- To move a vector, drag any point other than the endpoints. To manipulate the magnitude and/or direction, drag either end point.

**Note:** If you create an endpoint on an axis or another object, you can move the endpoint only along that object.

### Creating a Circle Arc

- From the **Points and Lines** menu, select **Circle Arc**. (In the Graphs application, click **Geometry > Points and Lines > Circle Arc**.)
- Click a location or point to establish the starting point of the arc.
- Click a second point to establish an intermediate point through which the arc will pass.
- Click a third point to set the ending point and complete the arc.

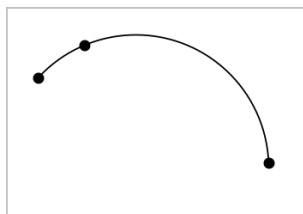

- To move an arc, drag its perimeter. To manipulate it, drag any of its three defining points.

### Creating Geometric Shapes

The Shape tools let you explore circles, polygons, conics, and other geometric objects.

As you create a shape, a tool appears in the work area (for example, **Circle** ). To cancel the shape, press **ESC**. To enable automatic labeling of certain objects, see *What You Must Know*, in this chapter.

### Creating a Circle

1. From the **Shapes** menu, select **Circle**. (In the Graphs application, click **Geometry > Shapes > Circle**.)
2. Click a location or point to position the circle's center point.
3. Click a location or point to establish the radius and complete the circle.

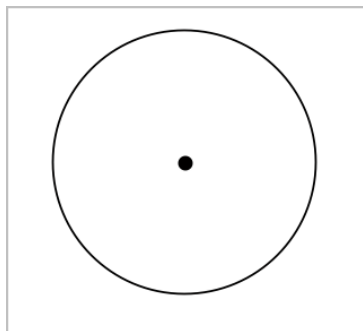

4. To resize a circle, drag its perimeter. To move it, drag its center point.

### Creating a Triangle

**Note:** To ensure that the sum of the angles of a triangle equals  $180^\circ$  or 200 gradians, you can force integer angles in the Geometry view. Refer to *What You Must Know*, in this chapter.

1. From the **Shapes** menu, select **Triangle**. (In the Graphs application, click **Geometry > Shapes > Triangle**.)
2. Click three locations to establish the vertices of the triangle.

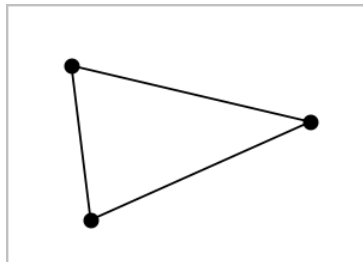

3. To manipulate a triangle, drag any point. To move it, drag any side.

### Creating a Rectangle

1. From the **Shapes** menu, select **Rectangle**. (In the Graphs application, click **Geometry > Shapes > Rectangle**.)
2. Click a location or point to establish the first corner of the rectangle.
3. Click a location for the second corner.

One side of the rectangle is displayed.

4. Click to establish the distance to the opposite side and complete the rectangle.

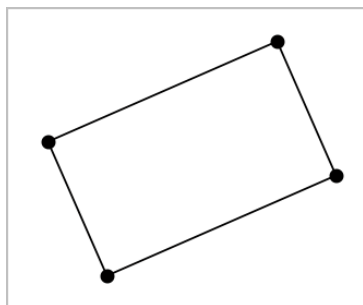

5. To rotate a rectangle, drag one of its first two points. To extend it, drag one of the last two points. To move it, drag any side.

### Creating a Polygon

1. From the **Shapes** menu, select **Polygon**. (In the Graphs application, click **Geometry > Shapes > Polygon**.)
2. Click a location or point to establish the first vertex of the polygon.
3. Click to establish each additional vertex.
4. To complete the polygon, click the first vertex.

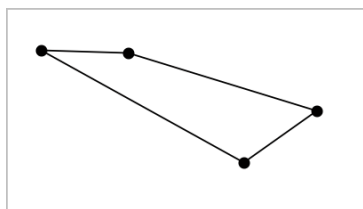

5. To manipulate a polygon, drag any vertex. To move it, drag any side.

## Creating a Regular Polygon

1. From the **Shapes** menu, select **Regular Polygon**. (In the Graphs application, click **Geometry > Shapes > Regular Polygon**.)
2. Click once on the work area to establish the center point.
3. Click a second location to establish the first vertex and radius.

A 16-sided regular polygon is formed. The number of sides is displayed in brackets; for example, {16}.

4. Drag any vertex in a circular motion to set the number of sides.
  - Drag clockwise to reduce the number of sides.
  - Drag counterclockwise to add diagonals.

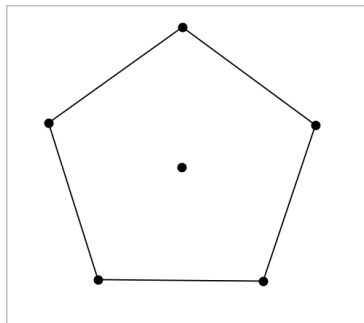

5. To resize or rotate a regular polygon, drag any of its points. To move it, drag any side.

## Creating an Ellipse

1. From the **Shapes** menu, select **Ellipse**. (In the Graphs application, click **Geometry > Shapes > Ellipse**.)
2. Click two locations or points to establish the foci.
3. Click to establish a point on the ellipse and complete the shape.

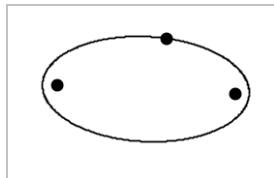

4. To manipulate an ellipse, drag any of its three defining points. To move it, drag its perimeter.

### Creating a Parabola (from focus and vertex)

1. From the **Shapes** menu, select **Parabola**. (In the Graphs application, click **Geometry > Shapes > Parabola**.)
2. Click a location to establish the focus.
3. Click a location to establish the vertex and complete the parabola.

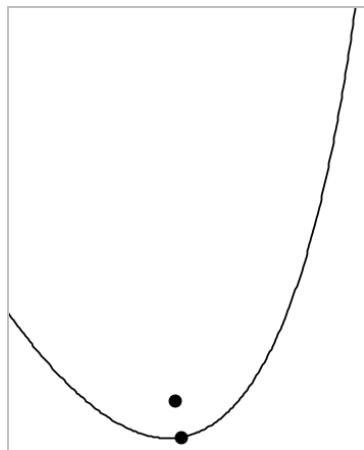

4. To manipulate a parabola, drag its focus or its vertex. To move it, drag it from any other point.

### Creating a Parabola (from focus and directrix)

1. Create a line to serve as the directrix.
2. From the **Shapes** menu, select **Parabola**. (In the Graphs application, click **Geometry > Shapes > Parabola**.)
3. Click a location to establish the focus.
4. Click the line to establish it as the directrix.

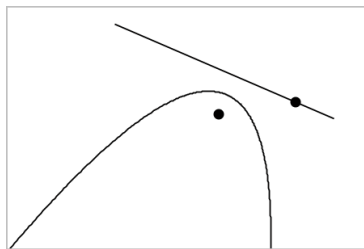

5. To manipulate a parabola, rotate or move its directrix or drag its focus. To move it, select both the directrix and the focus, and then drag either object.

### Creating a Hyperbola

1. From the **Shapes** menu, select **Hyperbola**. (In the Graphs application, click **Geometry > Shapes > Hyperbola**.)
2. Click two locations to establish the foci.
3. Click a third location to complete the hyperbola.

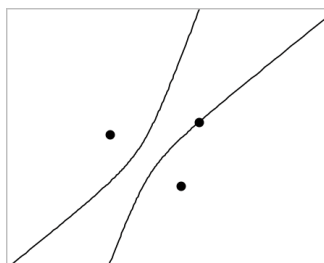

4. To manipulate a hyperbola, drag any of its three defining points. To move it, drag it from any other place on the shape.

### Creating a Conic by Five Points

1. From the **Shapes** menu, select **Conic by Five Points**. (In the Graphs application, click **Geometry > Shapes > Conic by Five Points**.)
2. Click five locations to establish the five points on the shape.

Depending on the pattern of the points, the conic can be a hyperbola or an ellipse.

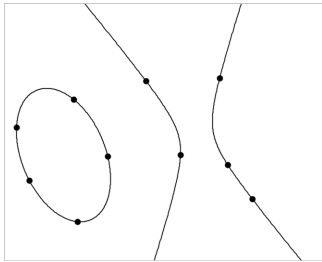

3. To manipulate a conic, drag any of its five defining points. To move it, drag it from any other place on the shape.

### ***Creating Shapes Using Gestures (MathDraw)***

The MathDraw tool lets you use touchscreen or mouse gestures to create points, lines, circles, and other shapes.

MathDraw is available in:

- Geometry view without the analytic window displayed.
- Graphing view when the x scale and y scale are identical. This avoids non-circular ellipses and non-square rectangles appearing as circles and squares.

MathDraw is not available in the 3D Graphing view or in the Geometry view with the analytic window displayed.

#### **Activating MathDraw**

1. If using the Geometry view with the analytic window visible, use the **View** menu to hide the window.
2. On the **Actions** menu, select **MathDraw**.

The MathDraw icon  appears. You can begin using the tool.

#### **Canceling MathDraw**

- ▶ When you have finished using the MathDraw tool, press **Esc**.

The tool also closes if you select a different tool or change views.

#### **Creating Points**

To create a labeled point, tap or click in an open area.

- If the point is close to an existing line, segment, ray, geometric conic (including circles), or polygon, the point snaps to that object. You can also place a point on the intersection of any two of those types of objects.



- If the point is close to a visible grid location in a Graphs view or the analytic window of a Geometry view, it snaps to the grid.

### Drawing Lines and Segments

To create a line or segment, touch or click the initial position, and then drag to the end position.

- If the drawn line passes near an existing point, the line snaps to the point.
- If the drawn line starts close to an existing point and ends next to another existing point, it becomes a segment defined by those points.
- If the drawn line is nearly parallel or perpendicular to an existing line, segment, or side of a polygon, it aligns to that object.

**Note:** The default tolerance for detecting parallel/perpendicular lines is 12.5 degrees. This tolerance can be redefined using a variable named `ti_gg_fd.angle_tol`. You can change the tolerance in the current problem by setting this variable in the calculator app to a value in the range 0 through 45 (0=no parallel/perpendicular detection).

### Drawing Circles and Ellipses

To create a circle or ellipse, use the touchscreen or mouse to draw the approximate shape.

- If the drawn shape is sufficiently circular, a circle is created.
- If the shape is elongated, an ellipse is created.
- If the virtual center of the drawn shape is near an existing point, the circle or ellipse is centered on that point.

### Drawing Triangles

To create a triangle, draw a triangle-like shape.

- If a drawn vertex is close to an existing point, the vertex snaps to the point.

### Drawing Rectangles and Squares

To create a rectangle or square, use the touchscreen or mouse to draw the perimeter.

- If the drawn shape is nearly square, a square is created.
- If the drawn shape is elongated, a rectangle is created.

- If the center of a square is close to an existing point, the square snaps to that point.

### Drawing Polygons

To create a polygon, tap or click a succession of existing points, ending on the first point you tapped.

### Using MathDraw to Create Equations

In the Graphs view, MathDraw attempts to recognize certain gestures as functions for analytic parabolas.

**Note:** The default step value for quantization of the parabola coefficients is  $1/32$ . The denominator of this fraction can be redefined using a variable named `ti_gg_fd.par_quant`. You can change the step value in the current problem by setting this variable to a value greater or equal to 2. A value of 2, for example, produces a step value of 0.5.

### Using MathDraw to Measure an Angle

To measure the angle between two existing lines, use the touchscreen or mouse to draw a circle arc from one of the lines to the other.

- If the intersection point between the two lines does not exist, it is created and labeled.
- The angle is not a directed angle.

### Using MathDraw to Find a Mid-point

To create a point midway between two points, tap or click point 1, point 2, and then point 1 again.

### Using MathDraw to Erase

To erase objects, use the touchscreen or mouse to drag left and right, similar to the motion of erasing a whiteboard.

- The erasure area is the bounding rectangle of the erasure gesture.
- All point objects and their dependents inside the erasure area are removed.

## ***Basics of Working with Objects***

### **Selecting and Deselecting Objects**

You can select an individual object or multiple objects. Select multiple objects when you want to quickly move, color, or delete them together.

1. Click an object or graph to select it.

The object flashes to indicate selection.

2. Click any additional objects to add them to the selection.
3. Perform the operation (such as moving or setting color).
4. To deselect all objects, click an empty space in the work area.

### **Grouping and Ungrouping Geometric Objects**

Grouping objects gives you a way to reselect them as a set, even after you have deselected them to work with other objects.

1. Click each object to add it to the current selection.

The selected objects flash.

2. Display a context menu of the selected object or objects.
3. Click **Group**. You can now select all the items in the group by clicking any of its members.
4. To split a group into individual objects, display a context menu of any of its member objects, and click **Ungroup**.

### **Deleting Objects**

1. Display the context menu of the object or objects.
2. Click **Delete**.

You cannot delete the origin, the axes, or points representing locked variables, even if those items are included in the selection.

### **Moving Objects**

You can move an object, group, or combination of selected objects and groups.

**Note:** If an immovable object (such as the graph axes or a point with locked coordinates) is included in a selection or group, you cannot move any of the objects. You must cancel the selection and then select only movable items.

To move this...	Drag this
A multiple-object selection or group	Any of its objects
A point	The point
A segment or vector	Any point other than an endpoint
A line or ray	The identifying point
A circle	The center point
Other geometric shapes	Any position on the object except one of its defining points. For example, move a polygon by dragging any of its sides.

### Constraining Object Movement

Holding down the **SHIFT** key before dragging lets you constrain how certain objects are drawn, moved, or manipulated.

Use the constraint feature to:

- Rescale only a single axis in the Graphs application.
- Pan the work area horizontally or vertically, depending on which direction you drag initially.
- Limit object movement to horizontal or vertical.
- Limit point placement to  $15^\circ$  increments as you draw a triangle, rectangle, or polygon.
- Limit angle manipulations to  $15^\circ$  increments.
- Limit the radius of a resized circle to integer values.

## Pinning Objects

Pinning objects prevents accidental changes as you move or manipulate other objects.

You can pin graphed functions, geometric objects, text objects, the graph axes, and the background.

1. Select the object or objects to pin, or click an empty area if you are pinning the background.
2. Display the context menu, and select **Pin**.

A pinned object displays a pin icon  when you point to it.

3. To unpin an object, display its context menu, and select **Unpin**.

### Notes:

- Although you cannot drag a pinned point, you can reposition it by editing its x and y coordinates.
- You cannot pan the work area while the background is pinned.

## Changing the Line or Fill Color of an Object

Color changes made in the software are displayed in shades of gray when you work on documents using a TI-Nspire™ CX handheld that does not support color. Color is preserved when you move documents back to the software.

1. Select the object or objects.
2. Display the object's context menu, click **Color**, and then click **Line Color** or **Fill Color**.
3. Select the color to apply to the objects.

## Changing the Appearance of an Object

1. From the **Actions** menu, select **Attributes**.
2. Click the object that you want to change. You can change shapes, lines, graphs, or graph axes.

The list of the attributes for the selected object are displayed.

3. Press **▲** and **▼** to move through the list of attributes.
4. At each attribute icon, press **◀** or **▶** to move through the options. For example, select **Thick**, **Thin**, or **Medium** for the **Line Weight** attribute.
5. Press **Enter** to apply the changes.

6. Press **ESC** to close the Attributes tool.

### Labeling Points, Geometric Lines, and Shapes

1. Display the context menu of the object.
2. Click **Label**.
3. Type the text of the label, and then press **Enter**.

The label attaches itself to the object and follows the object as you move it. The label's color matches the object's color.

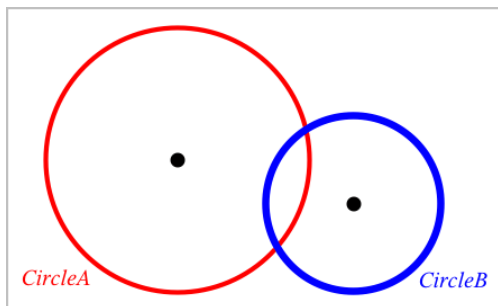

### Measuring Objects

Measurement values update automatically as you manipulate the measured object.

**Note:** Measurements of objects created in the Graphs application are displayed in generic units named  $u$ . Measurements of objects created in the Geometry application are displayed in centimeters ( $cm$ ).

#### Measuring Length of a Segment, Circle Arc, or Vector

1. From the **Measurement** menu, select **Length**. (In the Graphs application, click **Geometry > Measurement > Length**.)
2. Click the object to display its length.

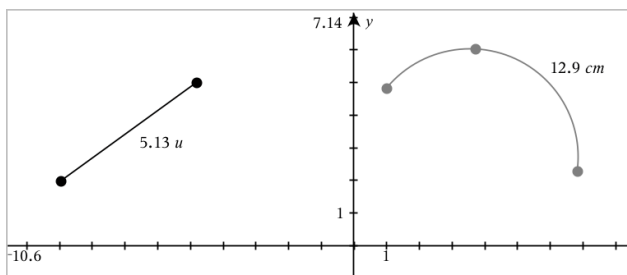

## Measuring Distance Between Two Points, a Point and a Line, or a Point and a Circle

1. From the **Measurement** menu, select **Length**. (In the Graphs application, click **Geometry > Measurement > Length**.)
2. Click the first point.
3. Click the second point or a point on the line or circle.

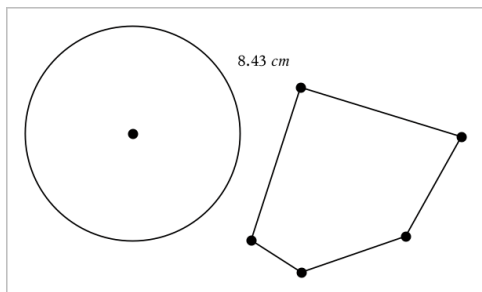

In this example, length is measured from the center of the circle to the upper left vertex of the polygon.

## Measuring Circumference of a Circle or Ellipse or the Perimeter of a Polygon, Rectangle, or Triangle

1. From the **Measurement** menu, select **Length**. (In the Graphs application, click **Geometry > Measurement > Length**.)
2. Click the object to display its circumference or perimeter.

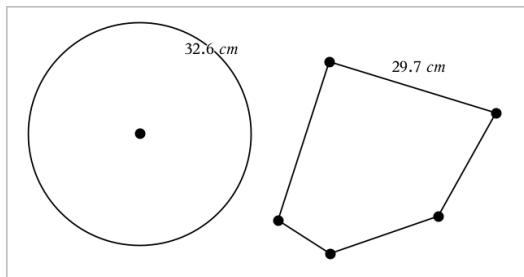

## Measuring a Side of a Triangle, Rectangle, or Polygon

1. From the **Measurement** menu, select **Length**. (In the Graphs application, click **Geometry > Measurement > Length**.)
2. Click two points on the object that form the side you want to measure.

**Note:** You must click *two points* to measure a side. Clicking the side measures the entire length of the object's perimeter.

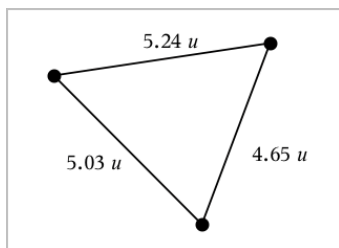

### Measuring Area of a Circle, Ellipse, Polygon, Rectangle, or Triangle

**Note:** You cannot measure the area of a polygon constructed using the Segment tool.

1. From the **Measurement** menu, select **Area**. (In the Graphs application, click **Geometry > Measurement > Area**.)
2. Click the object to display its area.

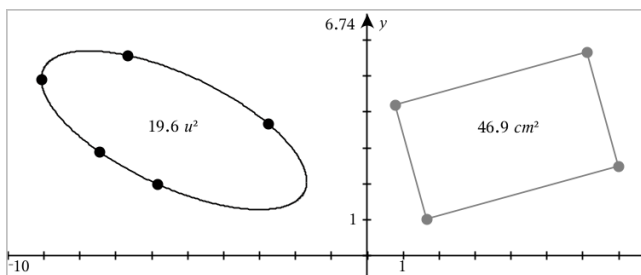

### Measuring Slope of a Line, Ray, Segment, or Vector

1. From the **Measurement** menu, select **Slope**. (In the Graphs application, click **Geometry > Measurement > Slope**.)
2. Click the object to display its slope.

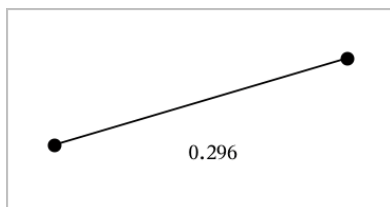

The value is updated automatically when you manipulate the object.



## Measuring Angles

Measured angles in the Geometry application range from  $0^\circ$  to  $180^\circ$ . Measured angles in the Graphs application range from 0 radians to  $\pi$  radians. To change the angle unit, use the **Settings** menu.

1. From the **Measurement** menu, select **Angle**. (In the Graphs application, click **Geometry > Measurement > Angle**.)
2. Click three locations or points to define the angle. The second click defines the vertex.

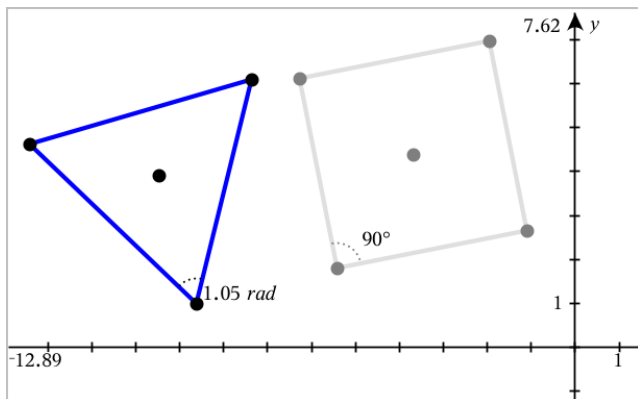

## Measuring Angles using the Directed Angle Tool

1. From the **Measurement** menu, select **Directed Angle**. (In the Graphs application, click **Geometry > Measurement > Directed Angle**.)
2. Click three locations or existing points to define the angle. The second click defines the vertex.

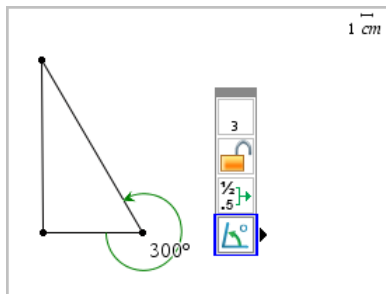

3. To reverse the measurement orientation,

- On the **Actions** menu, select **Attributes**.
- Click the angle text. For example, click  $300^\circ$ .
- Select the orientation attribute, and use the right or left arrow key to change it.
- Press **Esc** to close the Attributes tool.

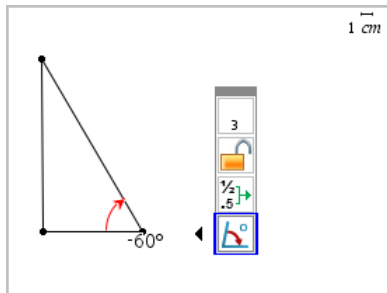

### Moving a Measured Value

- ▶ Drag the measurement to the desired location.

**Note:** If you move a measurement too far from its object, it stops following the object. However, its value continues to be updated as you manipulate the object.

### Editing a Measured Length

You can set the length of a side of a Triangle, Rectangle, or Polygon by editing its measured value.

- ▶ Double-click the measurement, and then enter the new value.

### Storing a Measured Value as a Variable

Use this method to create a variable and assign a measured value to it.

1. Display the item's context menu, and select **Store**.
2. Type a variable name for the stored measurement.

### Linking a Measured Length to an Existing Variable

Use this method to assign a measured length value to an existing variable.

1. Display the measurement's context menu, and select **Variables > Link to**.

The menu shows the list of currently defined variables.

2. Click the name of the variable you want to link to.

## Deleting a Measurement

- ▶ Display the measurement's context menu, and select **Delete**.

## Locking or Unlocking a Measurement

1. Display the measurement's context menu, and select **Attributes**.
2. Use the up/down arrow keys to highlight the Lock attribute.
3. Use the left/right arrow keys to close or open the lock.

As long as the value remains locked, manipulations are not allowed that would require the measurement to change.

## Transforming Objects

You can apply transformations to drawn objects in both the Graphs and Geometry applications. If the object's points are labeled, the corresponding points in the transformed object are labeled using prime notation ( $A \rightarrow A'$ ). To enable automatic labeling of certain objects, see *What You Must Know* in this chapter.

### Exploring Symmetry

1. From the **Transformation** menu, select **Symmetry**. (In the Graphs application, click **Geometry > Transformation > Symmetry**.)
2. Click the object whose symmetry you want to explore.
3. Click a location or existing point to establish the point of symmetry.

A symmetrical image of the object is displayed.

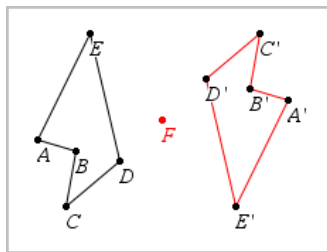

4. Manipulate the original object or the point of symmetry to explore the symmetry.

### Exploring Reflection

1. Create a line or segment to predefine the line about which the object will be reflected.

2. From the **Transformation** menu, select **Reflection**. (In the Graphs application, click **Geometry > Transformation > Reflection**.)
3. Click the object whose reflection you want to explore.
4. Click the predefined reflection line or segment.

A reflected image of the object is displayed.

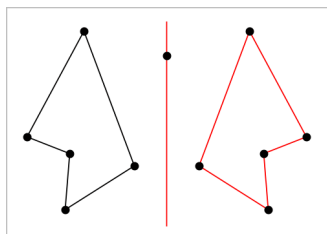

5. Manipulate the original object or the line of symmetry to explore the reflection.

### Exploring Translation

1. (Optional) Create a vector to predefine the distance and direction of translation.
2. From the **Transformation** menu, select **Translation**. (In the Graphs application, click **Geometry > Transformation > Translation**.)
3. Click the object whose translation you want to explore.
4. Click the predefined vector.

—or—

Click two locations on the work area to indicate the direction and distance of translation.

A translated image of the object is displayed.

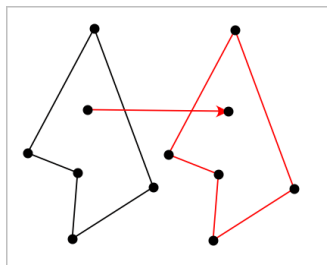

5. Manipulate the original object or the vector to explore the translation.

## Exploring Rotation

1. (Optional) Create an angle measurement to serve as a predefined angle of rotation.
2. From the **Transformation** menu, select **Rotation**. (In the Graphs application, click **Geometry > Transformation > Rotation**.)
3. Click the object whose rotation you want to explore.
4. Click a location or point to define the point of rotation.
5. Click the points of the predefined angle.  
—or—  
Click three locations to define an angle of rotation.

A rotated image of the object is displayed.

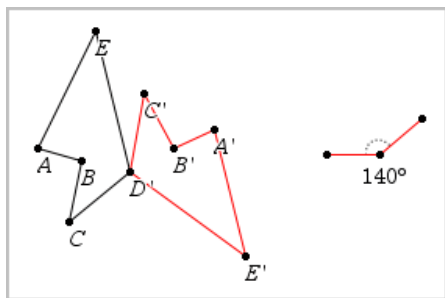

6. Manipulate the original object or the point of rotation to explore the rotation.

## Exploring Dilation

1. Create a Text object containing a numeric value to serve as a predefined dilation factor.

**Note:** You can also use a measured length value as the dilation factor. Keep in mind that if you use a large value, you may have to pan the display to view the dilated object.

2. From the **Transformation** menu, select **Dilation**. (In the Graphs application, click **Geometry > Transformation > Dilation**.)
3. Click the object whose dilation you want to explore.
4. Click a location or existing point to define the center point of dilation.
5. Click the Text object or measurement that defines the dilation factor.

A dilated image of the object is displayed.

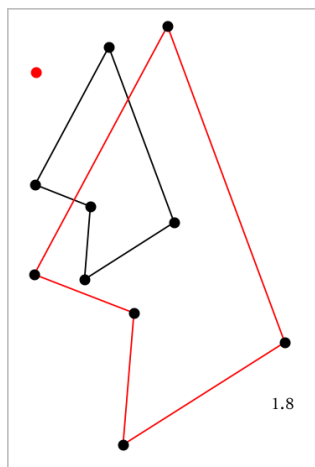

6. Manipulate the original object or the center point of dilation to explore the dilation. You can also edit the dilation factor.

### ***Exploring with Geometric Construction Tools***

While a construction is in progress, a tool appears in the work area (for example, **Parallel** ) . To cancel, press **ESC**.

#### **Creating a Midpoint**

This tool lets you bisect a segment or define a midpoint between any two points. The points can be on a single object, on separate objects, or on the work area.

1. From the **Construction** menu, select **Midpoint**. (In the Graphs application, click **Geometry > Construction > Midpoint**.)
2. Click a point or location to define the first point.
3. Click a second point or location to complete the midpoint.

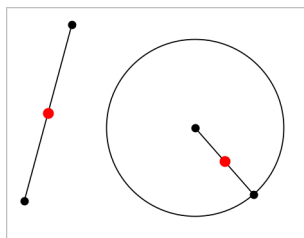

## Creating a Parallel Line

This tool creates a parallel line with respect to any existing line. The existing line can be a Graphs axis or any side of a triangle, square, rectangle, or polygon.

1. From the **Construction** menu, select **Parallel**. (In the Graphs application, click **Geometry > Construction > Parallel**.)
2. Click the object that will serve as the reference line.
3. Click a location to create the parallel line.

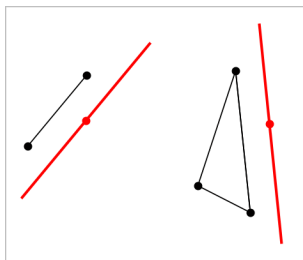

You can drag the parallel line to move it. If you manipulate the reference object, the line remains parallel.

## Creating a Perpendicular Line

You can create a line that is perpendicular to a reference line. The reference can be an axis, an existing line, a segment, or one side of a triangle, rectangle, or polygon.

1. From the **Construction** menu, select **Perpendicular**. (In the Graphs application, click **Geometry > Construction > Perpendicular**.)
2. Click a location or existing point through which the perpendicular line should pass.
3. Click the item that will serve as the reference line.

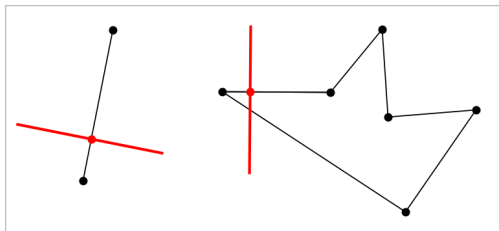

You can drag the intersection point to move the perpendicular. If you manipulate the reference object, the line remains perpendicular.

## Creating a Perpendicular Bisector

You can create a perpendicular bisector on a segment, on one side of a triangle, rectangle, or polygon, or between any two points.

1. From the **Construction** menu, select **Perpendicular Bisector**. (In the Graphs application, click **Geometry > Construction > Perpendicular Bisector**.)
2. Click the item that will serve as the reference line.  
—or—  
Click two points to create a perpendicular bisector between them.

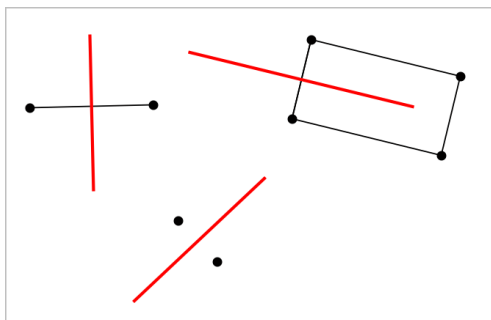

## Bisecting an Angle

This tool creates an angle bisector. The points of the angle can be on existing objects, or they can be locations on the work area.

1. From the **Construction** menu, select **Angle Bisector**. (In the Graphs application, click **Geometry > Construction > Angle Bisector**.)
2. Click three locations or points to define the angle. The second click defines the vertex of the angle.

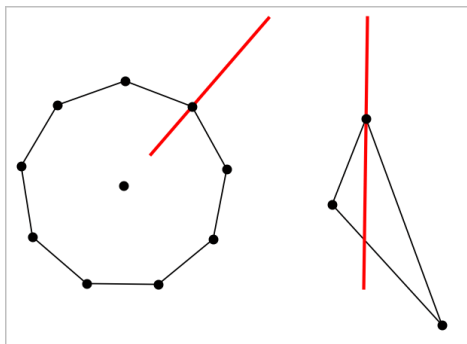



The angle bisector adjusts automatically as you manipulate its defining points.

### Creating a Locus

The Locus tool enables you to explore the range of motion of one object with respect to another object as constrained by a shared point.

1. Create a segment, line, or circle.
2. Create a point on the segment, line, or circle.

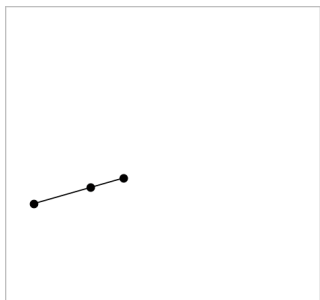

3. Create another object that uses the point created in the previous step.

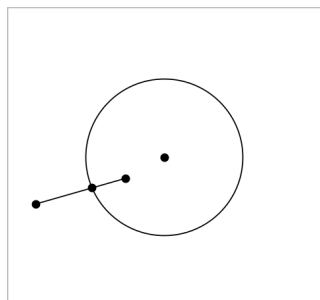

*Circle created to use the defined point on the segment.*

4. From the **Construction** menu, select **Locus**. (In the Graphs application, click **Geometry > Construction > Locus**.)
5. Click the point shared by the objects.
6. Click the object defined to share the point (this is the object to vary).

The continuous locus is displayed.

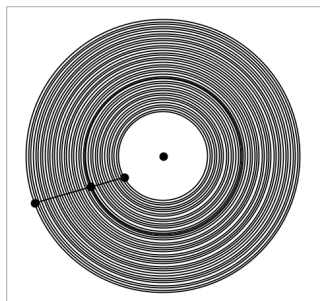

## Creating a Compass

This tool operates similarly to a geometric compass used for drawing circles on paper.

1. From the **Construction** menu, select **Compass**. (In the Graphs application, click **Geometry > Construction > Compass**.)
2. To set the width (radius) of the compass:

Click a segment.

—or—

Click any side of a triangle, rectangle, polygon, or regular polygon.

—or—

Click any two existing points or locations on the work area.

3. Click a location to establish the center of the circle and complete the construction.

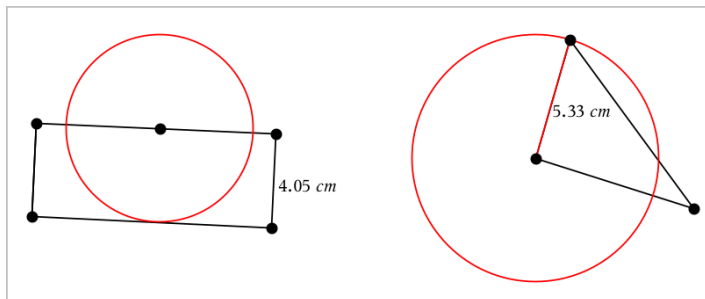

The radius adjusts automatically as you manipulate the original segment, side, or points used to define the radius.

## Using Geometry Trace

The Geometry Trace tool leaves a visible trail of a geometric object or function graph as it is moved or manipulated. The movement can be done manually or by [using animation](#). This tool is accessible in both the Graphs and Geometry applications.

1. From the **Trace** menu, select **Geometry Trace**.

The Geometry Trace tool appears.

2. Click the object or function that you want to trace to select it.
3. Drag the object, or play the animation.

This example shows traces of a graphed function manipulated by dragging and a triangle manipulated by animation.

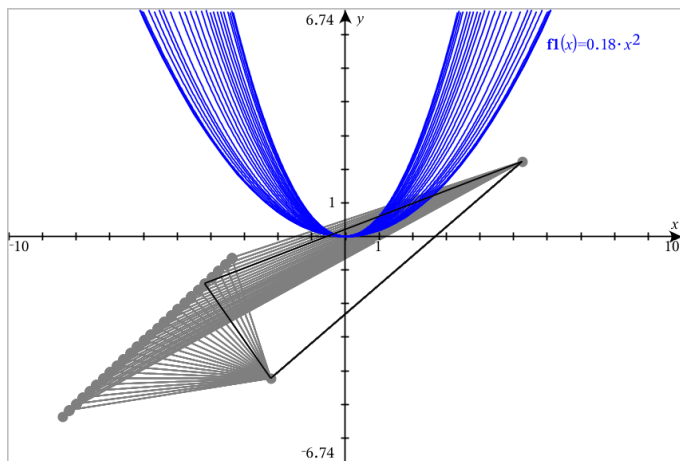

**Note:** You cannot select or manipulate the trace trail.

4. To erase all trails, select **Erase Geometry Trace** from the **Trace** menu.
5. To stop tracing, press **Esc**.

## Conditional Attributes

You can cause objects to hide, show, and change color dynamically, based on specified conditions such as " $r_1 < r_2$ " or " $\sin(a_1) \geq \cos(a_2)$ ."

For example, you might want to hide an object based on a changing measurement that you have assigned to a variable, or you might want an object's color to change based on a "Calculate" result assigned to a variable.

Conditional behaviors can be assigned to objects or groups in the Graphing, Plane Geometry, and 3D Graphing views.

## Setting Conditional Attributes of an Object

You can set conditions of a selected object either by using its context menu or by activating the Set Conditions tool from the **Actions** menu and then selecting the object. These instructions describe using the context menu.

1. Select the object or group.
2. Display the object's context menu, and click **Conditions**.

The conditional attributes are displayed.

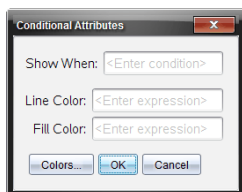

For 2D objects

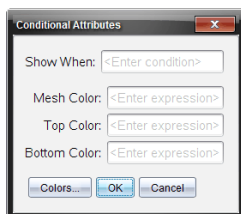

For 3D objects

3. (Optional) In the **Show When** field, enter an expression specifying the conditions during which the object will be shown. Anytime the condition is not satisfied, the object will be hidden.

You can specify tolerance by using compound conditionals in the **Show When** input field. For example, **area**>=4 and **area**<=6.

**Note:** If you need to see conditionally hidden objects temporarily, click **Actions > Hide/Show**. To return to normal viewing, press **ESC**.

4. (Optional) Enter numbers or expressions that evaluate to numbers in the applicable color fields, such as **Line Color** or **Mesh Color**. To see a map of color values, click the **Colors** button.

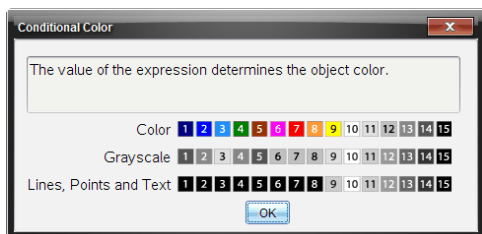

Map of conditional color values

5. Click **OK** in the Conditional Attributes dialog box to apply the conditions.

## Hiding Objects in the Geometry Application

The Hide/Show tool reveals objects you have previously selected as hidden and lets you select which objects to show or hide.

1. From the **Actions** menu, select **Hide/Show**.

The Hide/Show tool appears, and currently hidden items (if any) are shown dimmed.

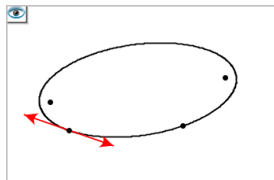

2. Click objects to toggle their hide/show status.

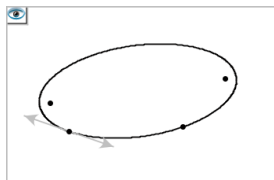

3. Press **Esc** to complete your selections and close the tool.

All objects you selected as hidden objects disappear.

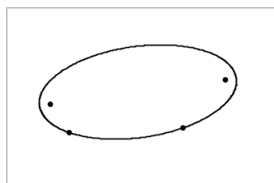

4. To view the hidden objects temporarily or restore them as shown objects, open the Hide/Show tool.

## Customizing the Geometry Work Area

### Inserting a Background Image

You can [insert an image](#) as a background for any Graphs or Geometry page.

1. From the **Insert** menu, click **Image**.
2. Navigate to the image you want to insert, select it, and then click **Open**.

## Adding a Text Object to the Work Area

Use the Text tool to add numeric values, formulas, observations, or other explanatory information to the Geometry work area.

1. From the **Actions** menu, select **Text**.
2. Click the location for the text.
3. Type the text in the box that appears, and then press **Enter**.

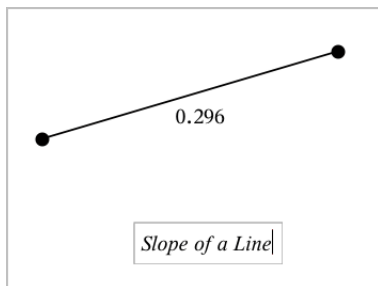

To move a text object, drag it. To edit the text, double-click it. To delete a text object, display its context menu, and select **Delete**.

## Changing the Attributes of Numeric Text

If you enter a numeric value as text, you can lock it or set its format and displayed precision.



1. From the **Actions** menu, select **Attributes**.
2. Click the numeric text to display its list of attributes.
3. Press **▲** and **▼** to move through the list.
4. At each attribute icon, press **◀** or **▶** to move through the options. For example, select **0** through **9** as the precision.
5. Press **Enter** to apply the changes.
6. Press **Esc** to close the Attributes tool.

## Animating Points on Objects



You can animate any point created as a point on an object or graph. Multiple points can be animated simultaneously.

### Animating a Point

1. From the **Actions** menu, select **Attributes**.
2. Click the point to display its attributes.
3. Press **▼** to select the animation attributes.
4. Press **◀** or **▶** to choose either unidirectional or alternating animation.

5. Type a value to set the animation speed. Any nonzero speed begins the animation. To reverse the direction, enter a negative value.
6. Press **Enter** to display the animation controls  .
7. Press **ESC** to close the Attributes tool.

### Pausing and Resuming All Animations

- ▶ To pause all animations on a page, click **Pause** .
- ▶ To resume all animations, click **Play** .

### Resetting All Animations

Resetting pauses all animations and returns all animated points to the positions they occupied when they were first animated.

- ▶ To reset animation, click **Reset** .

### Changing or Stopping the Animation of a Point

1. Click **Reset**  to stop all animation.
2. From the **Actions** menu, select **Attributes**.
3. Click the point to display its attributes.
4. Select the animation attribute, and type a new animation speed. To stop the point's animation, enter zero.

**Note:** If other animated points exist, the animation controls remain in the work area.

### *Adjusting Variable Values with a Slider*

A slider control lets you interactively adjust or animate the value of a numeric variable. You can insert sliders in the Graphs, Geometry, Notes, and Data & Statistics applications.

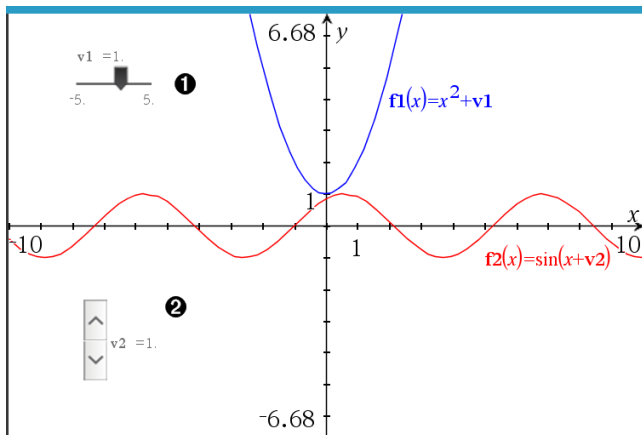

- ❶ Horizontal slider for adjusting variable  $v1$ .
- ❷ Minimized vertical slider for adjusting variable  $v2$ .

**Note:** TI-Nspire™ version 4.2 or higher is required for opening .tns files containing sliders on Notes pages.

### Inserting a Slider Manually

1. From a Graphs, Geometry, or Data & Statistics page, select **Actions > Insert Slider**.  
—Or—  
From a Notes page, make sure the cursor is not in a math box or chem box, and then select **Insert > Insert Slider**.

The Slider Settings screen opens.

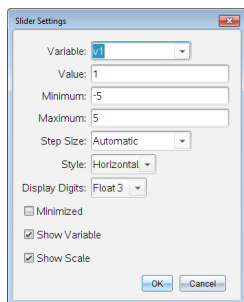

2. Enter the desired values, and click **OK**.

The slider is displayed. On a Graphs, Geometry, or Data & Statistics page, handles are displayed to let you move or stretch the slider.



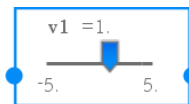

To remove the handles and use the slider, click an empty space in the work area. You can show the handles anytime by selecting **Move** from the slider's context menu.

3. To adjust the variable, slide the pointer (or click the arrows on a minimized slider).
  - You can use the **Tab** key to move the focus to a slider or to move from one slider to the next. The color of the slider changes to show you when it has the focus.
  - When a slider has the focus, you can use the arrow keys to change the value of the variable.

### Working with the Slider

Use the options on the context menu to move or delete the slider, and to start or stop its animation. You can also change the slider's settings.

1. Display the slider's context menu.

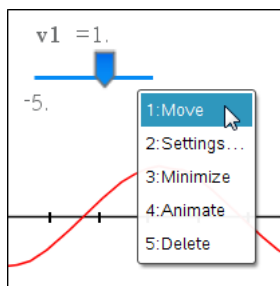

2. Click an option to select it.

### Automatic Sliders in Graphs

Sliders can be created for you automatically in the Graphs application and in the analytic window of the Geometry application. You are offered automatic sliders when you define certain functions, equations, or sequences that refer to undefined variables.

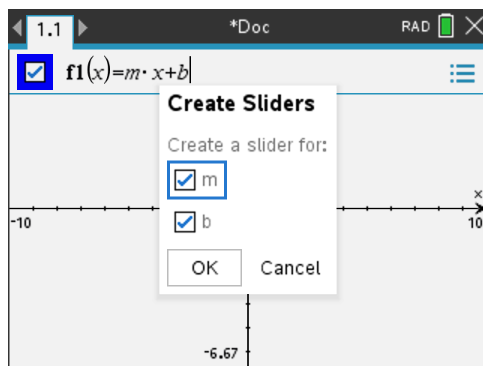

## Using the Calculate Tool

The Calculate tool is available in the Graphs and Geometry applications. It lets you evaluate a math expression you have entered as a text object.

The following example uses the Calculate tool to sum the measured angles of a triangle.

1. Using the **Shapes** menu, create a triangle, and then measure its angles.

**Tip:** You can enable options to automatically label points and to force geometric triangle angles to integers. For more information, see *What You Must Know*, in this chapter.

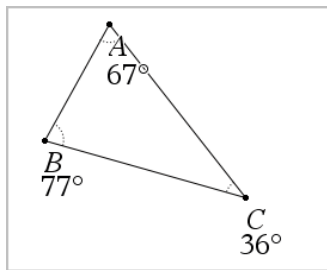

2. From the **Actions** menu, click **Text**.
3. Click a location for the text, and type the formula for the calculation.

In this example, the formula sums three terms.

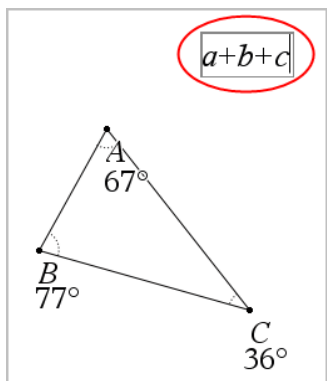

4. From the **Actions** menu, click **Calculate**.
5. Click the formula you created.

You are prompted to select a value for each term in the formula.

6. Click each angle measurement when prompted.

**Note:** If you have stored a measurement as a variable, you can select it when prompted by clicking . If the name of a stored measurement matches a term in the formula, you can press “L” when prompted for that term.

After you have selected the third term, the calculation result attaches itself to the pointer.

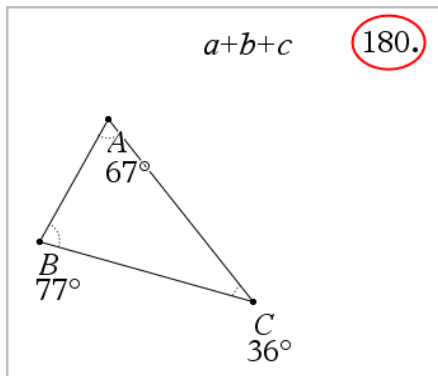

7. Position the result, and press **Enter** to anchor it as a new text object.

# Lists & Spreadsheet Application

The Lists & Spreadsheet application gives you a place to work with tabular data. It lets you:

- Store numeric data, text, or math expressions.
- Define a table cell in terms of the contents of other cells.
- Define an entire column based on the contents of another column.
- Share columns of data as list variables with other TI-Nspire™ applications. Also share individual cells as variables.
- Work with variables created in the Graphs & Geometry and Calculator applications.
- Collect tables of real-world data from sensors.
- Generate columns of data-based sequences that you define.
- Plot table data using the Data & Statistics application.
- Generate a table of values for a function.
- Copy and paste table data from the Lists & Spreadsheet application to other computer applications, such as TI Connect™ software and Excel® spreadsheet software.
- Perform statistical analysis on lists of data.

## Adding a Lists & Spreadsheet Page

- ▶ To start a new document with a blank Lists & Spreadsheet page:

From the main **File** menu, click **New Document**, and then click **Lists & Spreadsheet**.

Handheld: Press , and select **Lists & Spreadsheet** .

- ▶ To add a Lists & Spreadsheet page in the current problem of an existing document:

From the toolbar, click **Insert > Lists & Spreadsheet**.

Handheld: Press  and select **Insert > Lists & Spreadsheet**.

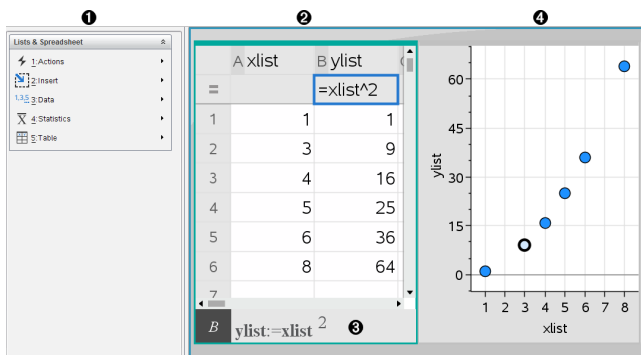

- 1 Lists & Spreadsheet tools (available when a Lists & Spreadsheet work area is active)
- 2 Sample Lists & Spreadsheet work area
- 3 Lists & Spreadsheet entry line
- 4 Lists & Spreadsheet data plotted in the Data & Statistics application

## ***Creating and Sharing Spreadsheet Data as Lists***

You can define a column as a named list of elements of the same type of data. After defining a list, you can link to it from the Graphs & Geometry, Calculator, or Data & Statistics applications, and from other instances of the Lists & Spreadsheet application within the current problem.

**Note:** Lists & Spreadsheet can display a maximum of 2500 elements in a list.

### **Sharing a Spreadsheet Column as a List Variable**

You share a column of data by naming it as a list variable.

**Note:** Avoid defining variables that use the same names as those used for statistical analysis. In some cases, an error condition could occur.

Variable names used for statistical analysis are listed in the *TI-Nspire™ Reference Guide*, under the **stat.results** entry.

1. Click the cell to move to the column's name cell (the top cell of the column).

—or—

Press **▲** as necessary.

2. Type a name for the list variable, and press **Enter**.

The column is now available as a list variable to other TI-Nspire™ applications.

3. Create elements in the list the same as you would create data in spreadsheet cells. For example, you can type the data into each cell or use a formula to generate a column of data.

### **Notes:**

- If a variable with the name you specified already exists in the current problem, Lists & Spreadsheet displays an error message.
- When you select the column formula cell of a list, it displays the list name in an expression similar to **width:=**.
- Lists can contain empty elements (denoted by “\_”).

- You can refer to a specific element in a named list from the Calculator application. Use the list name and the element's position within the list. In a list named Heights, for example, refer to the first element as Heights[1]. The expression Heights[2] refers to the second element, and so on.



### Linking to an Existing List Variable

Linking a column to an existing list variable lets you easily view and edit the values in the list. The list can be any shared list in the current problem and can be defined in Graphs & Geometry, Calculator, or any instance of Lists & Spreadsheet.

After you link a column to a list, Lists & Spreadsheet automatically shows any changes that you make to the list with other TI-Nspire™ applications.

1. Click the column formula cell (the second cell from the top) of the column that you want to link to the variable.
2. Type the name of the list variable you want to link to.

—or—

Click  on the toolbar (press  on the handheld), click **Link To**, and click the variable you want to link to.

3. Press **Enter**.

The column shows the list elements.

### Notes:

- You cannot link to the same variable multiple times on the same page.
- Use caution if you link to a system variable. Doing so could prevent the variable from being updated by the system. System variables include *ans* and statistics results (such as *stat.results*, *stat.RegEqn*, and *stat.Resid*).

### Inserting an Element in a List

When you insert an element in a list, the remaining elements shift downward to create space. No other columns are affected.

- ▶ Click **Insert > Insert Cell**.

### Deleting an Element from a List

When you delete an element, the remaining list elements shift upward to close the gap. The upward shift affects only the selected column.



1. Click the cell of the element to delete.
2. Open the context menu for the cell, and click **Delete Cell**.

**Note:** If you press **Del** or **Backspace** to clear the contents of the cell instead of deleting the list element, the element is assigned a value of 0 (zero). The remaining list elements do not shift.

## Creating Spreadsheet Data

You can type numeric values, text, or formulas into body cells. Column formula cells can contain formulas only. (For more information, see *Generating Columns of Data*.)

### Data Examples

Entry	Remarks
1.234	Simple numeric entry
"Green"	Text - Enclose categorical data (such as the names of colors used in a study) within quotes to distinguish them from variable names. Handheld: Press   to enter quoted data.
=a3*length	Formula - Consists of an "=" symbol followed by an expression. You can type the expression or use the Catalog and expression templates to build it. For more information, see the <i>Calculator</i> section. To ensure a decimal result instead of a fraction, type one of the integers in the expression as a decimal. For example, type <b>1.0</b> instead of <b>1</b> .

### Typing a Math Expression, Text, or Spreadsheet Formula

1. Double-click the cell to select it and put it in edit mode.

**Note:** If the cell is already selected, you can press **Enter** or click the entry line.

2. Type the expression, text, or formula. Be sure to enclose text entries in quotes and start formula entries with an "=" symbol.

As you type the data, it appears in the cell and on the entry line simultaneously.

3. Press **Enter** to complete the entry and move down to the next cell.

—or—

Press **Tab** to complete the entry and move right to the next cell.

The Lists & Spreadsheet application automatically recalculates any cells that are dependent on the cell you entered. If you have shared the cell, and other TI-Nspire™ applications are linked to the cell, the other applications are also updated.

**Note:** Empty cells in a spreadsheet display as a void represented by an underscore (\_). The underscore is automatically added to empty cells when a list is named or when an empty cell is referenced in a formula. When you plan to perform calculations on a range of cells, be sure to notice the location of void cells. Cells without a value can affect calculations. For example, if you include a void cell in the range for a sum such as “=b2+c2,” the result of the calculation is void (\_).

### Inserting a Cell Range into a Formula

The Select Range feature lets you insert a cell range (such as a1:b3) into a formula by selecting the range instead of typing cell addresses into an argument.

Suppose you want to calculate the mean of a range of cells.

1. Select the cell that will contain the result.
2. From the **Data** menu, click **List Math > Mean**.

An editable formula appears in the cell.

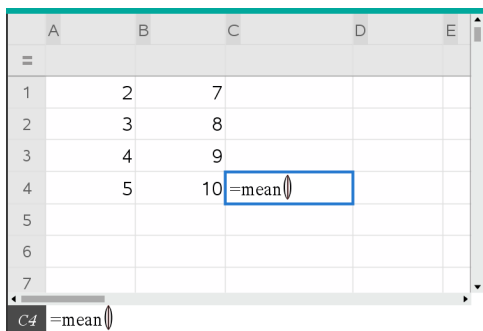

3. Click **Actions > Select > Select Formula Range**.
4. Drag a selection rectangle around the range of values for which you want to calculate the mean.

Handheld: Move to the first cell in the range, hold **⌘ shift**, and press the arrow keys.

The formula is updated as you select the cells.



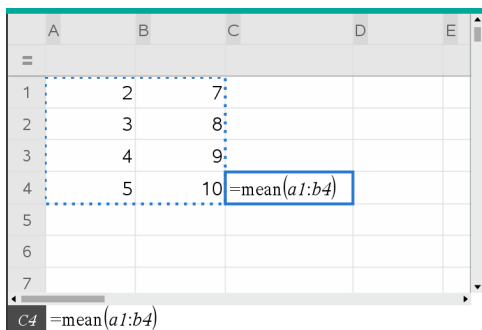

5. Press **Enter** to complete the formula and display the result.

## Navigating in a Spreadsheet

A spreadsheet includes a column letter at the top of each column and a row number on the left of each row. The top two rows and the row numbers remain in place as you scroll. You can name a column of data to make it available as a list variable in TI-Nspire™ applications.

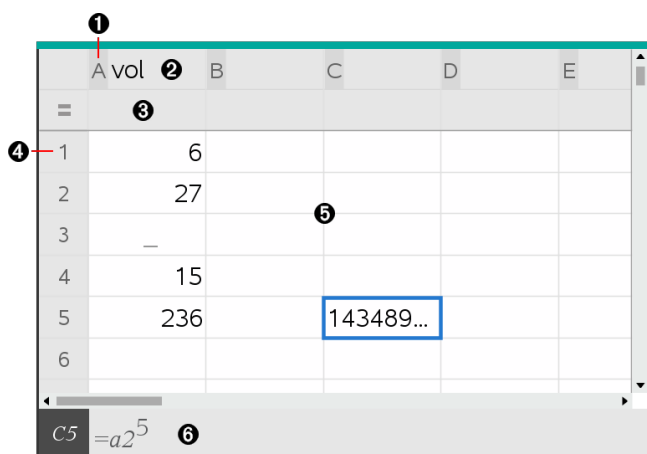

- 1 Column reference letter
- 2 Column name cell for defining a column as a list variable
- 3 Column formula cell for generating a column of data
- 4 Row reference number
- 5 Body Cells - Any empty (void) element in a list is displayed as an underscore ("\_"). Any value that cannot fit in a cell's width is truncated (**143489...**). Hover over the cell to display the complete value.

## 6 Entry line (includes cell reference for current cell)

You can select any cell to view or edit its contents. When a spreadsheet is larger than the Lists & Spreadsheet work area, you can move to different parts of the spreadsheet by using the **Tab** key and by pressing shortcut keys.

- ▶ Press **Tab** to move between the body of the spreadsheet (data zone) and the column names and formulas (naming zone).
- ▶ Press **◀**, **▶**, **▲**, and **▼** to move through the spreadsheet one cell at a time (move between cells within a zone). The arrow keys move the cursor from cell to cell and scroll as necessary to keep the selected cell in view.
- ▶ Move across several cells at a time by pressing **Page up**, **Page Dn**, **Home**, and **End**.

Handheld: Press **ctrl** **9** (**Page up**), **ctrl** **3** (**Page Dn**), **ctrl** **7** (**Home**), and **ctrl** **1** (**End**) keys.

- ▶ Use the **Go To** command on the **Actions** menu to select a specific cell. Type the cell's column letter and row number (such as **G16**).
- ▶ Press **Enter** to put the selected cell in Edit mode.
- ▶ Drag the scroll bar to move vertically without changing the cell or block of cells selected.

## Working with Cells

### Working with Color

The Lists & Spreadsheet application displays black text and cells with a white background by default. You can change the color of cells and text to emphasize or distinguish data. The colors and the order in which color is assigned is based on the TI-Nspire™ color palette.

### Changing the Fill Color of Cells

1. Select the cells to fill with color. You can choose one or more cells in any adjacent cells, columns, or rows.
2. Access the context menu and click **Color > Fill Color**.
3. Click the color to apply to the cells.

**Note:** If you combine color text and color cells, choose colors carefully to ensure visibility as you work with documents in the software and on the handheld.

## ***Changing the Color of Text***

1. Select the cells that contain the text to change. You can choose one or more cells in any adjacent cells, columns, or rows.
2. Access the context menu and click **Color > Text Color**.
3. Click the color to apply to the text. Empty cells in the selection area show the color change when text is added.

## **Understanding Cell References in Formulas**

Use a cell reference to use data from a cell or range of cells in a formula. The calculation results update automatically when values in cells change.

Relative references include only the cell's column letter and row number (for example, E7). A relative reference describes where a cell is in relation to other cells of the spreadsheet. The Lists & Spreadsheet application keeps track of relative cell references and adjusts the reference automatically when surrounding cells shift (because of actions you perform, such as column deletions or cell insertions).

Follow these guidelines to specify cell references:

- Include a column letter and row number in a relative reference.
- Include the \$ symbol before both the column letter and the row number to specify an absolute reference.
- Include a colon (:) between a two cell reference to specify a range of cells.

Absolute references include the \$ symbol before the column letter and before the row number (for example, \$B\$16). Absolute references always refer to the cell in a specific position in the spreadsheet. The application does not automatically adjust the cell reference when cell positions change.

## **Typing a Cell Reference in a Formula**

1. Double-click the cell and type the formula. For more information, see the *Calculator* section.
2. Move to the appropriate position in the formula and type the cell reference. Use the format for a relative reference (B3), absolute reference (\$B\$2), or range of cells (A1:A4).

**Note:** You can click **Recalculate** on the **Actions** menu to update all references and formula results in a spreadsheet.

## Deleting the Contents of Cells

1. Click a cell to select it.

—or—

Use the arrow keys to move to the cell.

**Note:** If you are deleting a range of cells, select a cell at one end or corner of the range, and then use **Shift** with the arrow keys to select the remaining cells in the range.

2. Press **Del**.

**Note:** Any cell that uses a formula with an absolute reference to deleted data shows an error. A cell that uses a formula with a relative reference to deleted data is updated to use the data currently in the referenced position.

## Copying Cells

When you copy cells, any formulas in the original cells are copied to the destination cells.

1. Click the cell to copy.

—or—

Use the arrow keys to move to the cell.

**Note:** If you are copying a range of cells, select a cell at one end or corner of the range, and then use **Shift** with the arrow keys to select the remaining cells in the range.

2. Use the standard key shortcut for copying a selection.

Windows®: Press **Ctrl+C**.

Mac®: Press **⌘+C**.

Handheld: Press  .

3. Click the cell where you want to duplicate the copied cell. If you are copying a block of data, click the cell that will become the upper left corner of the copied block.

4. Paste the selected cells:

Windows®: Press **Ctrl+V**.

Mac®: Press **⌘+V**.

Handheld: Press  .

**Important:** Paste copied data into a cell that is in the same mode as the cell from which the data was originally copied. Otherwise, a formula could paste as a string enclosed in quotes instead of a formula.

### Filling Adjacent Cells

You can repeat a cell's formula or value throughout adjacent cells within the row or column. You can also repeat a range of cells horizontally or vertically. If you fill from a range that contains a simple sequence (such as 2, 4, 6), the sequence continues in the filled cells.

1. Click the cell that contains the value or formula to repeat.

**Note:** If you are repeating a range of cells, drag to select the range, or select a cell at one end of the range, and then use **Shift** with the arrow keys to select the remaining cells.



2. Click **Data > Fill**.
3. Use the arrow keys, or drag to select the range that will hold the repetitions.
4. Press **Enter**.

The value, formula, or pattern that you selected for duplication is repeated over the selected range.

### Sharing a Cell Value as a Variable

You can share the value of a cell with other TI-Nspire™ applications by storing it as a variable. When you define or refer to a shared cell or variable in Lists & Spreadsheet, the name is preceded with an apostrophe (').

1. Click the cell that you want to share.
2. Click  on the toolbar, and click **Store Var** to store the cell's value.

Handheld: Press   or press  and select **Store Var**).

A formula is inserted into the cell with *var* as a placeholder for a variable name.



3. Type over the letters "*var*" with a name for the variable, and press **Enter**. Use a variable name that does not exist in the current problem.

The value is shown in bold to indicate that it is now available as a variable to other TI-Nspire™ applications.



## Linking a Cell to a Variable

When you link a cell to a variable, Lists & Spreadsheet keeps the cell value updated to reflect the current value of the variable. The variable can be any variable in the current problem and can be defined in Graphs & Geometry, Calculator, Data & Statistics, or any instance of Lists & Spreadsheet.

1. Click the cell that you want to link to a variable.
2. Click  on the toolbar, and click **Link to**.

Handheld: Press   or press  and select **Link to**.

The VarLink menu opens.

3. Under **Link To**, press , and  to scroll to the name of the variable.
4. Press **Enter**.



The cell shows the value of the variable.





**Note:** Use caution if you link to a system variable. Linking could prevent the variable from being updated by the system. System variables include statistics results (such as *Stat.RegEqn*, *Stat.dfError*, and *Stat.Resid*) and finance-solver variables (such as *tvm.n*, *tvm.pmt*, and *tvm.fv*).

## Working with Rows and Columns of Data

### Selecting a row or column

- ▶ To select a column, move to the top of the column and click the column reference letter. To select a row, move to the leftmost cell of the row and click the row reference number. Press **Esc** to cancel the selection.

**Handheld:** Hold down  to move past the top cell, or hold down  to move past the leftmost cell.

- ▶ To extend a selection to adjacent rows or columns, hold down **Shift** and press , , , or .

### Resizing a Row or Column

1. Click the row or column that you want to resize.
2. From the **Actions** menu, select **Resize**, and then select an option.
3. Choose a resizing option for a column or row.

- For a column, choose **Resize Column Width**, **Maximize Column Width**, or **Minimize Column Width**.
- For a row, you can choose **Resize Row Height**.

The tools that minimize and maximize the column width work automatically. You must manually adjust the size to use the **Resize Column Width** and **Resize Row Height** tools.

4. To resize manually, use ◀ and ▶ to resize the column, or use ▲ and ▼ to resize the row, and then press **Enter**.

### Inserting an Empty Row or Column

1. Click a column or row where you want to insert the new data.
2. From the **Insert** menu, select either **Row** or **Column**.
  - If you are inserting a row, the remaining rows shift down to create space for the new row.
  - If you are inserting a column, the remaining columns shift right to create space.

**Note:** If other cells contain formulas with relative references to a displaced row or column, those references adjust accordingly.

### Deleting Entire Rows or Columns

You can delete a row, column, group of rows, or group of columns. When you delete a row or column, the remaining rows or columns move up or left to fill the gap.

1. Click the column or row that you want to delete.
2. (Optional) To select adjacent rows or columns to delete, hold down **Shift** and press ◀, ▶, ▲, or ▼.
3. Display the context menu.
  - Windows®: Right-click the selected row.
  - Mac®: Hold the ⌘ key, and click the selected row.
  - Handheld: Press ctrl menu.
4. On the context menu, select **Delete Row**.

The selected rows or columns are deleted.

**Note:** If other cells contain formulas that refer to the deleted row or column, those cells show an error. Relative references to cells whose positions have changed because of a deletion adjust accordingly.

### Copying Rows or Columns

1. Click the row number to copy a row, or click the column letter to copy a column.
2. (Optional) To select adjacent rows or columns to copy, hold down **Shift** and press **◀**, **▶**, **▲**, or **▼**.
3. Copy the row or column:

Windows®: Press **Ctrl+C**.

Mac®: Press **⌘+C**.

Handheld: Press **ctrl** **C**.

4. Move to any cell in the row or column where you want to place the copied items.
5. Paste the row or column:

Windows®: Press **Ctrl+V**.

Mac®: Press **⌘+V**.

Handheld: Press **ctrl** **V**.

The copied row or column is pasted in place, replacing the previous contents.

**Note:** If you copy a named column, it is pasted with the name removed to prevent a variable conflict.

### Moving a Column

1. Click the column that you want to move.
2. From the **Actions** menu, select **Move Column**.  
An insertion bar appears.
3. Press **◀** and **▶** to place the insertion bar at the column's new position, and then press **Enter**.

**Note:** Relative references to any cell in a position is affected by the move adjust accordingly.



## Displaying Results as Exact or Approximate

You can choose to display a column's calculated results in Exact (fraction) or Approximate (decimal) form. This affects only the values calculated from a formula.

1. Select the column by clicking the reference letter at the top of the column.

Handheld: Hold down ▲ to move past the top cell.

2. Display the context menu for the column.
3. On the context menu, click either **Data > Exact** or **Data > Approximate**.

**Note:** To restore the column results to the document's default setting, select the column and click **Data > Restore Document Setting**.

## Clearing Column Data

The Clear Data command lets you remove the data from selected columns. Clear Data does not delete the column, and it does not clear a column's name or formula.

After clearing the data, Lists & Spreadsheet recalculates column formulas for the selected columns. This makes Clear Data useful for capturing a fresh set of data from another application or selectively generating a fresh column of random numbers.

1. Click the column or columns that you want to clear.
2. From the **Data** menu, select **Clear Data**.

**Note:** If a recalculated formula produces the same data as before, it may appear that the Clear Data command has failed.

## Sorting Data

You can sort a selected area of the spreadsheet in ascending or descending order. You select which column in the selected area will be used as the key for the sort. When the sort moves data up or down in the key column, the corresponding data in the other selected columns is also moved up or down. This preserves the integrity of each row.

**Note:** Sorting is based on numeric values. If you select a key column that contains text, you could get unexpected results.

1. Select the range of cells.

	A	B	C	D	E
=					
1		1 sue	345		1
2		2 bob	299		2
3		3 lori	601		3
4		4 burt	445		4
5		5 jean	563		5
6					
7					

- From the **Actions** menu, select **Sort**.

The **Sort** dialog box opens.

- Click the column letter to use for ordering.
- Click **Descending** or **Ascending** as the sort method, and then click **OK**.

	A	B	C	D	E
=					
1		5 jean	563		1
2		4 burt	445		2
3		3 lori	601		3
4		2 bob	299		4
5		1 sue	345		5
6					
7					

**Note:** Sorting a column that is defined by a formula will remove the formula, because it may not be valid after the sort.

## Generating Columns of Data

You can create a column of values based on the contents of another column. You can also create a column based on any of several types of sequential data.

Entering a formula in a column's formula cell tells the Lists & Spreadsheet application that you want to apply the formula to all cells in the column, not just to a single cell.

	A	B ①	C ②	D ③	E
=		=xbar*2	=a[]/2	=seqgen(u(n-1)+u(n	
1		1	25.	0.5	1
2		5	25.	2.5	5
3		15	25.	7.5	6
4		45	25.	22.5	11
5		7	25.	3.5	17
6			25.		28
7			25.		45

D =seqgen(u(n-1)+u(n-2),n,u,{1,255},{1,5},1)

- ❶ Column formula based on a variable
- ❷ Column formula based on another column (column A)
- ❸ Column formula that generates a sequence

**Notes:**

- If you generate data in a column that already contains one or more cell values, Lists & Spreadsheet asks for confirmation before replacing the existing values. Proceeding removes all of the existing values in the column.
- If you edit a cell manually in a column of generated data, Lists & Spreadsheet asks for confirmation before replacing the generated data. Proceeding removes the generated data for the entire column.

**Creating Column Values Based on Another Column**

1. Click the column formula cell (the second cell from the top) of the column where you want to use a formula.

Lists & Spreadsheet inserts the leading equal sign (=) for the formula. If the column is a named list, Lists & Spreadsheet inserts *listname*:= followed by the cursor.

2. Type the expression for the formula after the = and press **Enter** Use brackets ([]) after any column letter you include in the formula. For example, type =a[]^2 to create a column of values in which each cell is the square of the corresponding cell of column A.

Lists & Spreadsheet shows the formula in the formula cell and fills the column with the results.

	A	B	C	D	E
	=	=a[]^2			
1	12	144			
2	15	225			
3	18	324			
4	20	400			
5	21	441			
6					

**Generating a Column of Random Numbers**

This example generates a column of 20 random integers in the range 1 through 6.

1. Click the column formula cell (the second cell from the top) of the column.

Lists & Spreadsheet inserts the leading equal sign (=) for the formula. If the column is a named list, Lists & Spreadsheet inserts *listname:=* followed by the cursor.

2. After the equal sign, type **RandInt**( 1 , 6 , 20 ) .

**Note:** You can also use the Catalog or click **Data > Random > Integer** to insert the **RandInt()** function.

3. Press **Enter** to generate the numbers.

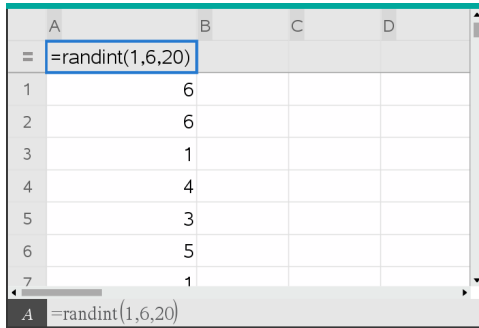

4. Generate (Recalculate) a new set of random numbers:

Windows®: Press **Ctrl+R**.

Mac®: Press **⌘+R**.

Handheld: Press **ctrl** **R**.

### Generating a Numerical Sequence

1. Click any cell in the column in which you want to generate the sequence.
2. From the **Data** menu, select **Generate Sequence**.

The Sequence dialog box opens.

3. Type the **Formula** that will be applied to the column values.
4. Type any **Initial Terms** required by the sequence. Separate them with commas.
5. Type a starting value for the independent variable (**n0**).
6. Type a maximum number of values to be generated (**nMax**).
7. Type the step value (**nStep**).
8. (Optional) Type a maximum value for the sequence in the **Ceiling Value** field.
9. Click **OK**.

Lists & Spreadsheet shows the formula in the formula cell and fills the column with the results.

A	B	C
=seqgen(n^2,n,u,{1,255},{2},1,50)		
1	2	
2	4	
3	9	
4	16	
5	25	
6	36	

## Graphing Spreadsheet Data

You can graph the data in a spreadsheet using Quick Graph or Summary Plot. Lists & Spreadsheet cells that contain no data are not represented by data points on graphs.

## Using Quick Graph

You can easily create a dot plot of the data in one column or a scatter plot of two adjacent columns by using the Quick Graph feature. This feature displays the graphed data using the Data & Statistics application.

To create a scatter plot:

1. Name both of the columns to declare them as lists.

	A xlist	B ylist	C	D	E
1	1	2			
2	2	4			
3	3	8			
4	4	16			
5	5	32			
6					
7					

2. Select both columns.

	A xlist	B ylist	C	D	E
1	1	2			
2	2	4			
3	3	8			
4	4	16			
5	5	32			
6					
7					

3. From the **Data** menu, select **Quick Graph**.

A Data & Statistics application is added to the page with the plotted data. The leftmost of the two lists is plotted on the x axis, and the other list is plotted on the y axis.

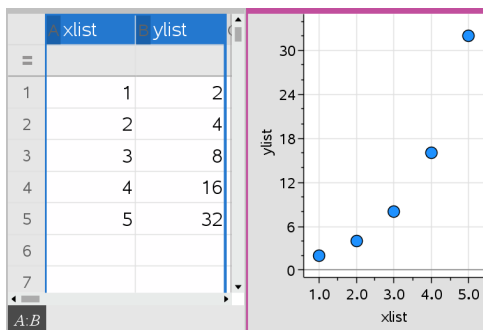

4. (Optional) Use the Data & Statistics features to analyze or visually enhance the graph.

**Note:** For more information, see *Using Data and Statistics*.

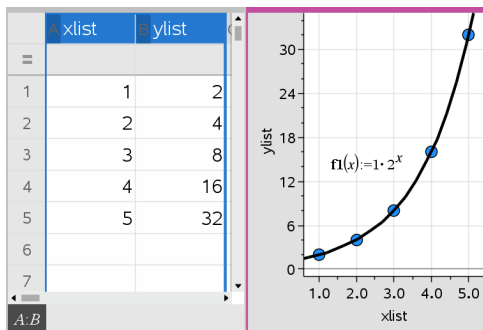

### Creating a Summary Plot from a Summary Table

In this example, you create a summary table from raw data, and then use the table to generate a summary plot. For more information, see *Using Data & Statistics*.

A	person	B	ht	C	wt	D	eyecolor	E	gender	F
1		1	56	130	blue	f				
2		2	55	150	blue	m				
3		3	60	200	green	f				
4		4	62	270	brown	m				
5		5	65	250	brown	f				
6		6	71	187	green	m				
7		7	62	176	brown	m				

Raw data

A	color	B	counts	C	D	E
1	blue		3			
2	green		3			
3	brown		4			
4						
5						
6						
7						

Summary table for eye color based on raw data

A summary table contains an X (or Y) List and a Summary List.

- The X (or Y) List contains numeric or string values (such as 1999 or “color”). Numeric values result in a histogram. String values identify the categories for a bar chart.
- The Summary List contains numeric values (such as count, frequency, or probability) for each element in the other list.

**To Create a Summary Plot:**

**Note:** For situations in which you already have a summary table, you can skip the first two steps.

1. Create a list that holds the category identifiers. For this example, name the list “color” and type strings for eye color. Enclose category names in quotes to prevent them from being interpreted as variables.

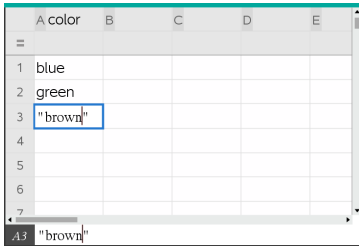

	A color	B	C	D	E
1	blue				
2	green				
3	"brown"				
4					
5					
6					
7					

2. Create the summary list. For this example, name the list “counts” and type the total count for each of the eye colors.

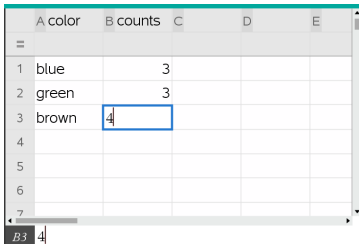

	A color	B counts	C	D	E
1	blue	3			
2	green	3			
3	brown	4			
4					
5					
6					
7					

3. Select either list by clicking the top cell of the column and pressing ▲.
4. From the **Data** menu, select **Summary Plot**.

The Summary Plot dialog box opens.



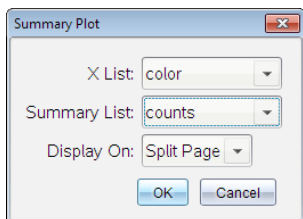

5. If necessary, use **Tab** and the arrow keys to select the correct lists for **X List** and **Summary List**.
6. In the **Display On** field, select how to display the summary plot in the Data & Statistics application.
  - Select **Split Page** to place the chart on half of the current page.
  - Select **New Page** to add the chart on a new page.

The summary plot is displayed with the list names along the axes and a summary plot symbol in the lower left corner of the chart window.

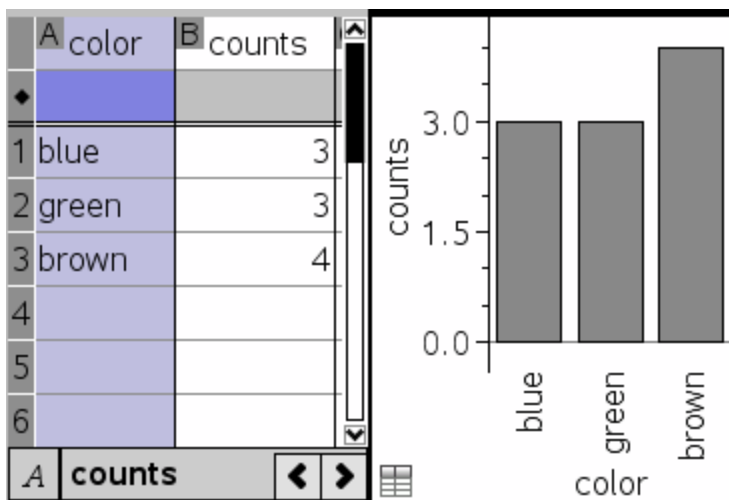

**Note:** In this example, the X List contains string data, so the summary plot displays as a bar chart. The category strings from the list display beneath the bars.

### **Exchanging Data with Other Computer Software**

You can use the TI-Nspire™ desktop software to copy table data to and from software outside the TI-Nspire™ applications, such as TI DataEditor (in the TI Connect™ software) and Excel® spreadsheet software.

For example, you can copy:

- The values of individual cells, a range of cells, or an entire list from TI DataEditor.
- The values (not the underlying formulas) of individual cells, a range of cells, or an entire column from an Excel® spreadsheet.
- A number from TI DataEditor.
- The value of a matrix from TI DataEditor.

#### Example - Copying Data from TI DataEditor

1. Open the TI Connect™ software.
2. Display the TI DataEditor.
3. If necessary, open the file containing the number, list, or matrix that you want to copy.

	L <sub>6</sub>
1	1.5567
2	2.2256
3	3.987
4	7.5326
5	13.33
6	

4. Drag to select the values that you want to copy. To copy an entire list, click the top cell in the list.

	L <sub>6</sub>
1	1.5567
2	2.2256
3	3.987
4	7.5326
5	13.33
6	

5. Click **Edit > Copy**.
6. In Lists & Spreadsheet, click the cell where you want the data to be pasted.

If you have copied a range of cells, they will be pasted so that the upper-left corner of the range is positioned at the selected cell. Any data in those cells will be overwritten.

7. Click **Edit > Paste**.

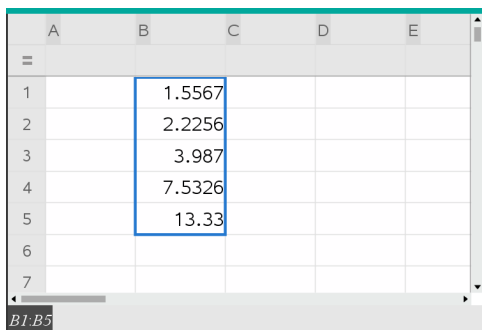

## Copying Cells from an Excel® Spreadsheet

You can copy up to 26 columns and 2500 rows from an Excel® spreadsheet to a Lists & Spreadsheet application.

1. Drag to select the values that you want to copy from the Excel® spreadsheet. To copy an entire column, click the column identifier at the top of the column.

**Note:** If you select non-contiguous columns in the Excel® spreadsheet, they will be pasted as contiguous columns in Lists & Spreadsheet.

2. Use the standard key shortcut for copying a selection.

Windows®: Press **Ctrl+C**.

Mac®: Press **⌘+C**.

3. In Lists & Spreadsheet, click the cells where you want the data to be pasted.

If you are copying a range of cells, they will be pasted so that the upper-left corner of the range is positioned at the selected cell. Any data in those cells in will be overwritten.

4. Paste the data.

Windows®: Press **Ctrl+V**.

Mac®: Press **⌘+V**.

Handheld: Press **ctrl** **V**.

**Note:** Categorical data must be enclosed in quotes (" ") after the data is pasted.

## Capturing Data from Graphs & Geometry

You can use Lists & Spreadsheet application to capture information about objects in the Graphs & Geometry application. For example, you could track changes in the area of a triangle as you change the length of a side in the Graphs & Geometry application.

Captured values replace values in the column. If you prefer, you can remove all data from a column before starting a new capture by clicking **Clear Data** on the **Data** menu.

### Capturing Data Manually

1. Make sure the data value that you want to capture is linked to a variable name.
2. Click the column formula cell (the second cell from the top) of the column in which you want to capture the values.

**Note:** Captured values replace values in the column.

3. Click **Data > Data Capture > Manual**.

A capture expression is inserted into the column formula cell with *var* as a placeholder for the name of the variable you are capturing.

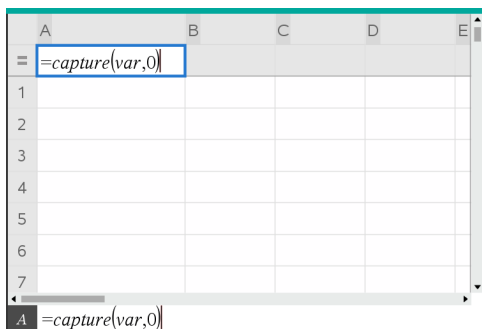

4. Replace the letters “*var*” with the name of the variable to capture from Graphs & Geometry. For example, type **area**.

The formula cell now contains an expression similar to `=capture(area,0)`.



**Note:** The argument “0” tells Lists & Spreadsheet that you want to trigger each capture manually.

5. Press **Enter**.

6. From the Graphs & Geometry application, change the object with a measured value stored as the variable (area, in this example) referenced in the data capture expression.
7. Each time you are ready to capture the current value of area, press the capture keys.

Windows®: Press **Ctrl**+. (the period key).

Mac®: Hold down **⌘** and press . (the period key).

Handheld: Press  .

The current *area* value is added to the end of the list as a list element.

### Capturing Data Automatically

When you capture data automatically, you can specify that you want the captures to be triggered by:

- Changes in the captured variable only.
- Changes in the captured variable or additional variables.

This lets you set up multiple columns of synchronized captures, such as the x and y coordinates of a moving object.

1. Clear all columns that you will be using for the captured data.
2. Make sure any data values that you want to capture are linked to variable names.
3. Click the column formula cell (the second cell from the top) of the column in which you want to capture the values.
4. Click **Data >Data Capture >Automatic**.

A capture expression is inserted into the column formula cell with *var* as a placeholder for the name of the variable you are capturing.

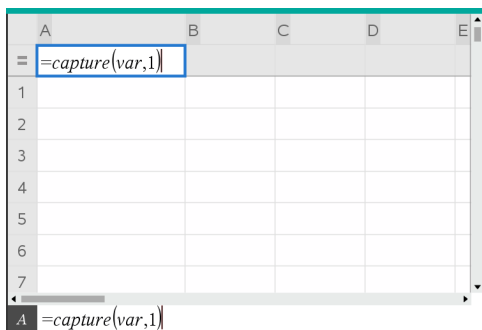

5. Replace the letters “var” with the name of the variable to capture. For example, type `objpathX`. Alternatively, you can select the variable name from the Variables menu.

The formula cell now contains an expression similar to `=capture(objpathX,1)`.



**Note:** The argument “1” tells Lists & Spreadsheet that you want the captures to be triggered by the variable change.

6. If you want the capture to also be triggered by changes in an additional variable or variables, type a comma after the 1, and then type the variable name or the name of a list that itemizes the variables.

The formula cell will contain an expression similar to `=capture(objpathX,1,objpathY)`.

7. Press **Enter** to complete the formula.
8. If you are capturing multiple columns of synchronized data, set up the additional columns. For example, you might set up a second capture variable using `=capture(objpathY,1,objpathX)`.
9. When you are ready to capture the values, begin moving the object or start the animation that affects it in Graphs & Geometry.

Each captured value is added to the end of the list.

## Synchronizing Captured Data for a Point

To ensure that both coordinate values for a point are captured even if only one coordinate changes, you can add `{ 'a', 'b' }` in the third argument of the capture expression.

1. In a Graphs & Geometry application, create a point with variables **(a,b)**.

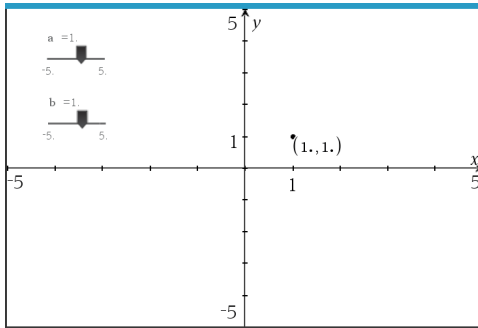

2. Add a Lists & Spreadsheets application to the problem.
3. Enter the capture expressions for both variables.

Column A: `=capture('a,1,{ 'a', 'b' })`

Column B: `=capture('b,1,{ 'a', 'b' })`

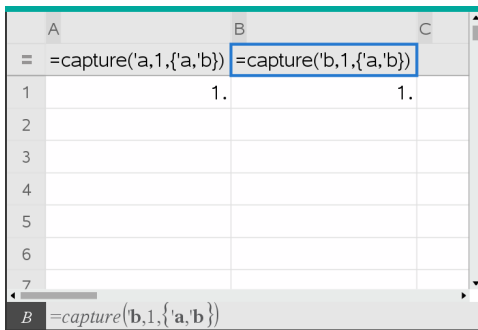

A screenshot of a spreadsheet application. The spreadsheet has columns A, B, and C, and rows 1 through 7. The formula bar at the bottom shows the expression `=capture('b,1,{ 'a', 'b' })`. The spreadsheet content is as follows:

	A	B	C
=	<code>=capture('a,1,{ 'a', 'b' })</code>	<code>=capture('b,1,{ 'a', 'b' })</code>	
1		1.	1.
2			
3			
4			
5			
6			
7			

4. Move the slider for variable **a**.

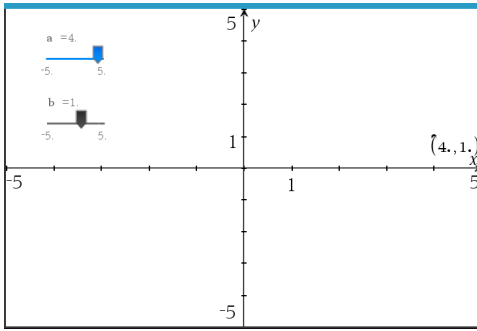

The data captured for **b** synchronizes accordingly.

A	B	C
=	=capture('a,1,{a,'b})	=capture('b,1,{a,'b})
1	1.	1.
2	2.	1.
3	3.	1.
4	4.	1.
5	4.	2.
6	4.	3.
7		

B1:B4

5. Move the slider for variable **b**.

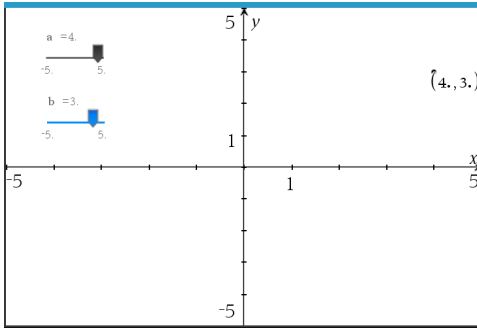

The data captured for **a** synchronizes accordingly.



A	B	C
=capture('a,1,{ 'a,'b})	=capture('b,1,{ 'a,'b})	
1	1.	1.
2	2.	1.
3	3.	1.
4	4.	1.
5	4.	2.
6	4.	3.
7		

## Using Table Data for Statistical Analysis

Tools on the Statistics menu provide access to wizards that help you perform statistical analyses on the data in table columns. You specify the location of the data, and Lists & Spreadsheet stores the results in two columns: one for the result names, and one for the corresponding values.

### Plotting Statistical Data

Some statistics wizards include a **Draw** check box. By default, the box is not selected. Selecting this box creates a Data & Statistics work area on the page, displays the calculated results in Lists & Spreadsheet, and draws the results of the statistical analysis in the Data & Statistics work area.

**Note:** For functions that support the **Draw** option, the option is available only if you type the function in a column formula cell.

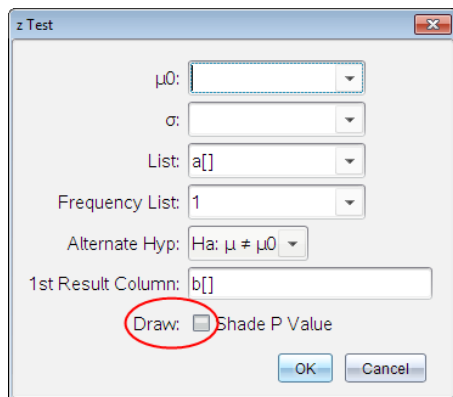

**Draw** check box (as shown in the **z Test** wizard).

## Statistics Input Descriptions

The following table describes the different inputs used in Lists & Spreadsheet wizards.

Input	Description
$\mu_0$	Hypothesized value of the population mean that you are testing.
$\sigma$	The known population standard deviation; must be a real number $> 0$ .
List	The name of the list containing the data you are testing.
Frequency List	The name of the list containing the frequency values for the data in <b>List</b> . Default=1. All elements must be integers $\geq 0$ . The frequency values can also be typed as a list, in the format {1, 1, 3, 2}.
$\bar{x}$ , Sx, n	Summary statistics (mean, standard deviation, and sample size) for the one-sample tests and intervals.
$\sigma_1$	The known population standard deviation from the first population for the two-sample tests and intervals. Must be a real number $> 0$ .
$\sigma_2$	The known population standard deviation from the second population for the two-sample tests and intervals. Must be a real number $> 0$ .
List 1, List 2	The names of the lists containing the data you are testing for the two-sample tests and intervals.
Frequency 1, Frequency 2	The names of the lists containing the frequencies for the data in <b>List 1</b> and <b>List 2</b> for the two-sample tests and intervals. Defaults=1. All elements must be integers $\geq 0$ .
$\bar{x}_1$ , Sx1, n1, $\bar{x}_2$ , Sx2, n2	Summary statistics (mean, standard deviation, and sample size) for sample one and sample two in two-sample tests and intervals.
Pooled	Specifies whether variances are to be pooled for <b>2-Sample t Test</b> and <b>2-Sample t Interval</b> .
$p_0$	The expected sample proportion for <b>1-Prop z Test</b> . Must be a real number, such that $0 < p_0 < 1$ .
x	The count of successes in the sample for the <b>1-Prop z Test</b> and <b>1-Prop z Interval</b> . Must be an integer $\geq 0$ .
n	The count of observations in the sample for the <b>1-Prop z Test</b> and <b>1-Prop z Interval</b> . Must be an integer $> 0$ .

Input	Description
x1	The count of successes from sample one for the <b>2-Prop z Test</b> and <b>2-Prop z Interval</b> . Must be an integer $\geq 0$ .
x2	The count of successes from sample two for the <b>2-Prop z Test</b> and <b>2-Prop z Interval</b> . Must be an integer $\geq 0$ .
n1	The count of observations in sample one for the <b>2-Prop z Test</b> and <b>2-Prop z Interval</b> . Must be an integer $> 0$ .
n2	The count of observations in sample two for the <b>2-Prop z Test</b> and <b>2-Prop z Interval</b> . Must be an integer $> 0$ .
C-Level	The confidence level for the interval instructions. Must be $\geq 0$ and $< 100$ . If it is $\geq 1$ , it is assumed to be given as a percent and is divided by 100. Default=0.95.
RegEQ	The prompt for the name of the function where the calculated regression equation is to be stored.

## Statistical Calculations

### Performing a Statistical Calculation

You can perform statistical calculations to analyze data. The following example fits a  $y=mx+b$  linear regression model to the two lists in columns A and B.

1. From the **Statistics** menu, select **Stat Calculation > LinearRegression (mx+b)** to choose the regression model.

The Linear Regression (mx+b) dialog box opens.

2. Type **a [ ]** as the column for the **X List**.
3. Type **b [ ]** as the column for the **Y List**.
4. To store the regression equation in a specified variable, replace **Save RegEqn To** with the name of the variable.
5. Type **c [ ]** as the column for the **1st Result**.

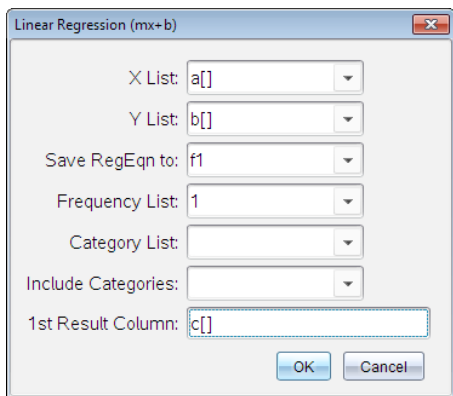

6. Click **OK**.

Lists & Spreadsheet inserts two columns: one containing the names of the results, and one containing the corresponding values.

	A	B	C	D
=				=LinRegMx(a[],b[],1): C
1	1	7	Title	Linear Regression (mx+..
2	2	12	RegEqn	m*x+b
3	3	17	m	5.
4	4	22	b	2.
5	5	27	r <sup>2</sup>	1.
6			r	1.
7			Resid	{0.,0.,0.,0.,0.}
D	=LinRegMx(a[[]],b[[]],1): CopyVar Stat.RegEqn./?			

**Note:** The results are linked to the source data. For example, if you change a value in column A, the regression equation is updated automatically.

### Storing Statistical Results

Lists & Spreadsheet stores statistical results using a variable-group name with the format `stat.nnn`, where `nnn` is the result name (for example, `stat.RegEqn` and `stat.Resid`). The use of standard names for variables makes it easier to identify and use the statistical variables later. If you want to use a custom variable group instead of the standard name, you can edit the formula in the column formula cell.

You could use the following formula to store the results in the variable group **MystatsB**.

**=LinRegMx(a[],b[],1): CopyVar Stat., MystatsB.**

Later, you could view the results by entering the following expression in the Calculator application or in another column of the Lists & Spreadsheet application:

**MystatsB.results**

## Supported Statistical Calculations

The **Stat Calculations** menu lets you select from the calculations described below. For more information, see the *TI-Nspire™ Reference Guide*.

### One-Variable Statistics (OneVar)

Analyzes data with one measured variable. You can specify an optional frequency list. The statistical data returned using this analysis technique are:

- Sample mean,  $\bar{x}$
- Sum of the data,  $\Sigma x$
- Sum of the squared data,  $\Sigma x^2$
- Sample standard deviation,  $s_x$
- Population standard deviation,  $\sigma_x$
- Sample size,  $n$
- X-min
- First quartile,  $Q_1$
- Median
- Third quartile,  $Q_3$
- X-max
- Sum of squared deviations,  $SS_x = \Sigma(x - \bar{x})^2$

### Two-Variable Statistics (TwoVar)

Analyzes paired data. *List 1* is the independent variable. *List 2* is the dependent variable. You can specify an optional frequency list. The statistical data returned using this analysis technique are:

For each list:

- Sample mean,  $\bar{x}$  or  $\bar{y}$
- Sum of the data,  $\Sigma x$  or  $\Sigma y$
- Sum of the squared data,  $\Sigma x^2$  or  $\Sigma y^2$

- Sample standard deviation,  $s_x = s_{n-1}X$  or  $s_y = s_{n-1}Y$
- Population standard deviation,  $\sigma_x = \sigma_n X$  or  $\sigma_y = \sigma_n Y$
- X-min or Y-min
- First quartile,  $Q_1X$  or  $Q_1Y$
- Median
- Third quartile,  $Q_3X$  or  $Q_3Y$
- X-max or Y-max
- Sum of squared deviations,  $SS_x = \sum(x - \bar{x})^2$  or  $SS_y = \sum(y - \bar{y})^2$

Additional data:

- Sample size for each data set,  $n$
- $\sum xy$
- Correlation coefficient,  $R$ .

### **Linear Regression ( $mx+b$ ) (LinRegMx)**

Fits the model equation  $y=mx+b$  to the data using a least-squares fit. It displays values for **m** (slope) and **b** (y-intercept).

### **Linear Regression ( $a+bx$ ) (LinRegBx)**

Fits the model equation  $y=a+bx$  to the data using a least-squares fit. It displays values for **a** (y-intercept), **b** (slope),  $r^2$ , and  $r$ .

### **Median-Median Line (MedMed)**

Fits the model equation  $y=mx+b$  to the data using the median-median line (resistant line) technique, calculating the summary points  $x_1, y_1, x_2, y_2, x_3,$  and  $y_3$ . **Median-Median Line** displays values for **m** (slope) and **b** (y-intercept).

### **Quadratic Regression (QuadReg)**

Fits the second-degree polynomial  $y=ax^2+bx+c$  to the data. It displays values for **a**, **b**, **c**, and  $R^2$ . For three data points, the equation is a polynomial fit; for four or more, it is a polynomial regression. At least three data points are required.

### **Cubic Regression (CubicReg)**

Fits the third-degree polynomial  $y=ax^3+bx^2+cx+d$  to the data. It displays values for **a**, **b**, **c**, **d**, and  $R^2$ . For four points, the equation is a polynomial fit; for five or more, it is a polynomial regression. At least four points are required.

### ***Quartic Regression (QuartReg)***

Fits the fourth-degree polynomial  $y=ax^4+bx^3+cx^2+dx+e$  to the data. It displays values for **a**, **b**, **c**, **d**, **e**, and **R<sup>2</sup>**. For five points, the equation is a polynomial fit; for six or more, it is a polynomial regression. At least five points are required.

### ***Power Regression (PowerReg)***

Fits the model equation  $y=axb$  to the data using a least-squares fit on transformed values  $\ln(x)$  and  $\ln(y)$ . It displays values for **a**, **b**, **r<sup>2</sup>**, and **r**.

### ***Exponential Regression (ExpReg)***

Fits the model equation  $y=ab^x$  to the data using a least-squares fit on transformed values  $x$  and  $\ln(y)$ . It displays values for **a**, **b**, **r<sup>2</sup>**, and **r**.

### ***Logarithmic Regression (LogReg)***

Fits the model equation  $y=a+b \ln(x)$  to the data using a least-squares fit on transformed values  $\ln(x)$  and  $y$ . It displays values for **a**, **b**, **r<sup>2</sup>**, and **r**.

### ***Sinusoidal Regression (SinReg)***

Fits the model equation  $y=a \sin(bx+c)+d$  to the data using an iterative least-squares fit. It displays values for **a**, **b**, **c**, and **d**. At least four data points are required. At least two data points per cycle are required to avoid aliased frequency estimates.

**Note:** The output of **SinReg** is always in radians, regardless of the Radian/Degree mode setting.

### ***Logistic Regression (d=0) (Logistic)***

Fits the model equation  $y=c/(1+a \cdot e^{-bx})$  to the data using an iterative least-squares fit. It displays values for **a**, **b**, and **c**.

### ***Logistic Regression (d≠0) (LogisticD)***

Fits the model equation  $y=c(1+a \cdot e^{-bx})+d$  to the data using an iterative least-squares fit. It displays values for **a**, **b**, **c** and **d**.

### ***Multiple Linear Regression (MultReg)***

Calculates multiple linear regression of list Y on lists X1, X2, ..., X10.

## ***Distributions***

### **Calculating a Distribution**

Example: Calculate a distribution to fit the Normal Pdf distribution model.

1. Click the column formula cell (second cell from the top) in column A.
2. Click **Statistics > Distributions > Normal Pdf** to choose the Distribution model.

The Normal Pdf dialog box opens and displays fields for typing or selecting the arguments for the calculation.

3. Press **Tab** as necessary to move from field to field and provide each argument. You can type values, or select them from the drop down list:
  - **X Value:** Click the drop-down arrow to choose any list in the problem to provide the x values for the calculation.
  - **Mean:** Type a value for the mean or click the drop-down arrow to choose a variable that contains the mean.
  - **Standard Deviation:** Type a value for the standard deviation or choose a variable that contains the standard deviation.
4. Click the **Draw** check box to see the distribution plotted in Data & Statistics.

**Note:** The Draw option is not available for all distributions.

5. Click **OK**.

Lists & Spreadsheet inserts two columns: one containing the names of the results, and one containing the corresponding values. The results are plotted in Data & Statistics.

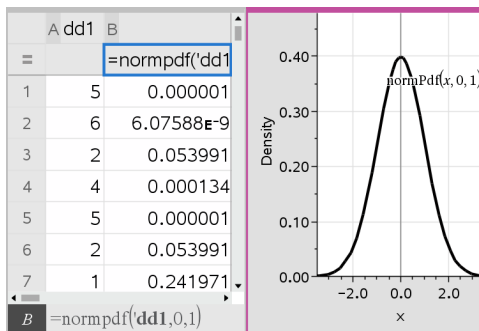

**Note:** The results are linked to the source data. For example, you can change a value in Column A, and the equation updates automatically.



## Supported Distribution Functions

The following distributions are available from the Lists & Spreadsheet application. For more information regarding these functions, see the *TI-Nspire™ Reference Guide*.

- To return a single distribution result based on a single value, type the function in a single cell.
- To return a list of distribution results based on a list of values, type the function in a column formula cell. In this case, you specify a list (column) that contains the values. For each value in the list, the distribution returns a corresponding result.

**Note:** For distribution functions that support the draw option (**normPDF**, **t PDF**,  **$\chi^2$  Pdf**, and **F Pdf**), the option is available only if you type the distribution function in a formula cell.

### Normal Pdf (**normPdf**)

Computes the probability density function (**pdf**) for the normal distribution at a specified  $x$  value. The defaults are mean  $\mu=0$  and standard deviation  $\sigma=1$ . The probability density function (pdf) is:

$$f(x) = \frac{1}{\sqrt{2\pi}\sigma} e^{-\frac{(x-\mu)^2}{2\sigma^2}}, \sigma > 0$$

This distribution is used to determine the probability of the occurrence of a certain value in a normal distribution. The draw option is available when Normal PDF is invoked from a formula cell.

When you access distributions from the formula cell, you must select a valid list from the drop-down list to avoid unexpected results. If accessed from a cell, you must specify a number for the  $x$ -value. The distribution returns the probability that the value you specify will occur.

### Normal Cdf (**normCdf**)

Computes the normal distribution probability between *Lower Bound* and *Upper Bound* for the specified mean,  $\mu$  (default=0) and the standard deviation,  $\sigma$  (default=1). You can click the **Draw (Shade area)** check box to shade the area between the lower and upper bounds. Changes to the initial *Lower Bound* and *Upper Bound* automatically update the distribution.

This distribution is useful in determining the probability of an occurrence of any value between the lower and upper bounds in the normal distribution. It is equivalent to finding the area under the specified normal curve between the bounds.

### **Inverse Normal (invNorm)**

Computes the inverse cumulative normal distribution function for a given *area* under the normal distribution curve specified by mean,  $\mu$ , and standard deviation,  $\sigma$ .

This distribution is useful in determining the x-value of data in the area from 0 to  $x < 1$  when the percentile is known.

### **t Pdf (tPdf)**

Computes the probability density function (**pdf**) for the t-distribution at a specified *x* value. *df* (degrees of freedom) must be  $> 0$ . The probability density function (**pdf**) is:

$$f(x) = \frac{\Gamma[(df+1)/2]}{\Gamma(df/2)} \frac{(1+x^2/df)^{-(df+1)/2}}{\sqrt{\pi df}}$$

This distribution is useful in determining the probability of the occurrence of a value when the population standard deviation is not known and the sample size is small. The draw option is available when **t Pdf** is invoked from a formula cell.

### **t Cdf (tCdf)**

Computes the Student-t distribution probability between *Lower Bound* and *Upper Bound* for the specified *df* (degrees of freedom). You can click the **Draw (Shade area)** check box to shade the area between the bounds. Changes to the initial *Lower Bound* and *Upper Bound* automatically update the distribution.

This distribution is useful in determining the probability of the occurrence of a value within an interval defined by the lower and upper bound for a normally distributed population when the population standard deviation is not known.

### **Inverse t (invt)**

Computes the inverse cumulative t-distribution probability function specified by Degrees of Freedom, *df*, for a given area under the curve.

This distribution is useful in determining the probability of an occurrence of data in the area from 0 to  $x < 1$ . This function is used when the population mean and/or population standard deviation is not known.

## $\chi^2$ Pdf ( $\chi^2$ Pdf())

Computes the probability density function (**pdf**) for the  $\chi^2$  (chi-square) distribution at a specified  $x$  value.  $df$  (degrees of freedom) must be an integer  $> 0$ . The probability density function (**pdf**) is:

$$f(x) = \frac{1}{\Gamma(df/2)} (1/2)^{df/2} x^{df/2-1} e^{-x/2}, x \geq 0$$

This distribution is useful in determining the probability of the occurrence of a given value from a population with a  $\chi^2$  distribution. The draw option is available when  $\chi^2$  **Pdf** is invoked from a formula cell.

## $\chi^2$ Cdf ( $\chi^2$ Cdf())

Computes the  $\chi^2$  (chi-square) distribution probability between *lowBound* and *upBound* for the specified  $df$  (degrees of freedom). You can click the **Draw Shade area** check box to shade the area between the lower and upper bounds. Changes to the initial *lowBound* and *upBound* automatically update the distribution.

This distribution is useful in determining the probability of the occurrence of value within given boundaries of a population with a  $\chi^2$  distribution.

## F Pdf (F Pdf())

Computes the probability density function (**pdf**) for the F distribution at a specified  $x$  value. *numerator df* (degrees of freedom) and *denominator df* must be integers  $> 0$ . The probability density function (**pdf**) is:

$$f(x) = \frac{\Gamma[(n+d)/2]}{\Gamma(n/2)\Gamma(d/2)} \left(\frac{n}{d}\right)^{n/2} x^{n/2-1} (1+nx/d)^{-(n+d)/2}, x \geq 0$$

where  $n$  = numerator degrees of freedom  
 $d$  = denominator degrees of freedom

This distribution is useful in determining the probability that two samples have the same variance. The draw option is available when F Pdf is invoked from a formula cell.

## F Cdf (F Cdf())

Computes the F distribution probability between *lowBound* and *upBound* for the specified *dfnumer* (degrees of freedom) and *dfDenom*. You can click the **Draw (Shade area)** check box to shade the area between the lower and upper bounds. Changes to the initial *lowBound* and *upBound* automatically update the distribution.

This distribution is useful in determining the probability that a single observation falls within the range between the lower bound and upper bound.

### **Binomial Pdf (binomPdf())**

Computes a probability at  $x$  for the discrete binomial distribution with the specified *numtrials* and probability of success ( $p$ ) on each trial. The  $x$  parameter can be an integer or a list of integers.  $0 \leq p \leq 1$  must be true. *numtrials* must be an integer  $> 0$ . If you do not specify  $x$ , a list of probabilities from 0 to *numtrials* is returned. The probability density function (**pdf**) is:

$$f(x) = \binom{n}{x} p^x (1-p)^{n-x} \quad x = 0, 1, \dots, n$$

where  $n = \text{numtrials}$

This distribution is useful in determining the probability of success in a success/failure trial, at trial  $n$ . For example, you could use this distribution to predict the probability of getting heads in a coin toss on the fifth toss.

### **Binomial Cdf (binomCdf())**

Computes a cumulative probability for the discrete binomial distribution with  $n$  number of trials and probability  $p$  of success on each trial.

This distribution is useful in determining the probability of a success on one trial before all trials are completed. For example, if heads is a successful coin toss and you plan to toss the coin 10 times, this distribution would predict the chance of obtaining heads at least once in the 10 tosses.

### **Inverse Binomial (invBinom())**

Given the number of trials (*NumTrials*) and the probability of success of each trial (*Prob*), this function returns the minimum number of successes,  $k$ , such that the cumulative probability of  $k$  successes is greater than or equal to the given cumulative probability (*CumulativeProb*).

### **Inverse Binomial with respect to N (invBinomN())**

Given the probability of success of each trial (*Prob*), and the number of successes (*NumSuccess*), this function returns the minimum number of trials,  $N$ , such that the cumulative probability of  $x$  successes is less than or equal to the given cumulative probability (*CumulativeProb*).

### **Poisson Pdf (poissPdf())**

Computes a probability at  $x$  for the discrete Poisson distribution with the specified mean,  $\mu$ , which must be a real number  $> 0$ .  $x$  can be an integer or a list of integers. The probability density function (**pdf**) is:

$$f(x) = e^{-\mu} \mu^x / x!, x = 0, 1, 2, \dots$$

This distribution is useful in determining the probability of obtaining a certain number of successes before a trial begins. For example, you could use this calculation to predict the number of heads that would occur in eight tosses of a coin.

### **Poisson Cdf (poissCdf())**

Computes a cumulative probability for the discrete Poisson distribution with specified mean,  $\bar{x}$ .

This distribution is useful in determining the probability that a certain number of successes occur between the upper and lower bounds of a trial. For example, you could use this calculation to predict the number of heads displayed between coin toss #3 and toss #8.

### **Geometric Pdf (geomPdf())**

Computes a probability at  $x$ , the number of the trial on which the first success occurs, for the discrete geometric distribution with the specified probability of success  $p$ .  $0 \leq p \leq 1$  must be true.  $x$  can be an integer or a list of integers. The probability density function (pdf) is:

$$f(x) = p(1-p)^{x-1}, x = 1, 2, \dots$$

This distribution is useful in determining the likeliest number of trials before a success is obtained. For example, you could use this calculation to predict the number of coin tosses that would be made before a heads resulted.

### **Geometric Cdf (geomCdf())**

Computes a cumulative geometric probability from lowBound to upBound with the specified probability of success,  $p$ .

This distribution is useful in determining the probability associated with the first success occurring during trials 1 through  $n$ . For example, you could use this calculation to determine the probability that heads display on toss #1, #2, #3, ..., # $n$ .

## **Confidence Intervals**

### **Supported Confidence Intervals**

The following confidence intervals are available from the Lists & Spreadsheets application. For more information regarding these functions, see the *TI-Nspire™ Reference Guide*.

### ***z Interval (zInterval)***

Computes a confidence interval for an unknown population mean,  $\mu$ , when the population standard deviation,  $\sigma$ , is known. The computed confidence interval depends on the user-specified confidence level.

This test is useful in determining how far from a population mean a sample mean can get before indicating a significant deviation.

### ***t Interval (tInterval)***

Computes a confidence interval for an unknown population mean,  $\mu$ , when the population standard deviation,  $\sigma$ , is unknown. The computed confidence interval depends on the user-specified confidence level.

This test is useful in examining whether the confidence interval associated with a confidence level contains the value assumed in the hypothesis. Like the *z Interval*, this test helps you determine how far from a population mean a sample mean can get before indicating a significant deviation when the population mean is unknown.

### ***2-Sample z Interval (zInterval\_2Samp)***

Computes a confidence interval for the difference between two population means ( $\mu_1 - \mu_2$ ) when both population standard deviations ( $\sigma_1$  and  $\sigma_2$ ) are known. The computed confidence interval depends on the user-specified confidence level.

This test is useful in determining if there is statistical significance between the means of two samples from the same population. For example, this test could determine whether there is significance between the mean college entrance test score of female students and the mean of college entrance test score of male students at the same school.

### ***2-Sample t Interval (tInterval\_2Samp)***

Computes a confidence interval for the difference between two population means ( $\mu_1 - \mu_2$ ) when both population standard deviations ( $\sigma_1$  and  $\sigma_2$ ) are unknown. The computed confidence interval depends on the user-specified confidence level.

This test is useful in determining if there is statistical significance between the means of two samples from the same population. It is used instead of the 2-sample *z* confidence interval in situations where the population is too large to measure to determine the standard deviation.

### ***1-Prop z Interval (zInterval\_1Prop)***

Computes a confidence interval for an unknown proportion of successes. It takes as input the count of successes in the sample  $x$  and the count of observations in the sample  $n$ . The computed confidence interval depends on the user-specified confidence level.

This test is useful in determining the probability of a given number of successes that can be expected for a given number of trials. For instance, casino examiners would use this test to determine if observed payouts for one slot machine demonstrate a consistent pay out rate.

## **2-Prop z Interval (zInterval\_2Prop)**

Computes a confidence interval for the difference between the proportion of successes in two populations ( $p_1 - p_2$ ). It takes as input the count of successes in each sample ( $x_1$  and  $x_2$ ) and the count of observations in each sample ( $n_1$  and  $n_2$ ). The computed confidence interval depends on the user-specified confidence level.

This test is useful in determining if two rates of success differ because of something other than sampling error and standard deviation. For example, a bettor could use this test to determine if there is an advantage in the long run by playing one game or machine versus playing another game or machine.

## **Linear Reg t Intervals (LinRegIntervals)**

Computes a linear regression t confidence interval for the slope coefficient  $b$ . If the confidence interval contains 0, this is insufficient evidence to indicate that the data exhibits a linear relationship.

## **Multiple Reg Intervals (MultRegIntervals)**

Computes multiple regression prediction confidence interval for the calculated  $y$  and a confidence for  $y$ .

## **Stat Tests**

### **Supported Statistical Tests**

Hypothesis tests are available from the Lists & Spreadsheets application. For more information regarding these functions, see the *TI-Nspire™ Reference Guide*.

Some of the wizards for Stat Tests display a **Draw** check box. By default, the box is not selected. Selecting the box creates a Data & Statistics work area on the page and plots the results in that work area.

### **z test (zTest)**

Performs a hypothesis test for a single unknown population mean,  $\mu$ , when the population standard deviation,  $\sigma$ , is known. It tests the null hypothesis  $H_0: \mu = \mu_0$  against one of the alternatives below.

- $H_a: \mu \neq \mu_0$
- $H_a: \mu < \mu_0$
- $H_a: \mu > \mu_0$

This test is used for large populations that are normally distributed. The standard deviation must be known.

This test is useful in determining if the difference between a sample mean and a population mean is statistically significant when you know the true deviation for a population.

### **t test (tTest)**

Performs a hypothesis test for a single unknown population mean,  $\mu$ , when the population standard deviation,  $\sigma$ , is unknown. It tests the null hypothesis  $H_0: \mu = \mu_0$  against one of the alternatives below.

- $H_a: \mu \neq \mu_0$
- $H_a: \mu < \mu_0$
- $H_a: \mu > \mu_0$

This test is similar to a z-test, but is used when the population is small and normally distributed. This test is used more frequently than the z-test because small sample populations are more frequently encountered in statistics than are large populations.

This test is useful in determining if two normally distributed populations have equal means, or when you need to determine if a sample mean differs from a population mean significantly and the population standard deviation is unknown.

### **2-Sample z Test (zTest\_2Samp)**

Tests the equality of the means of two populations ( $\mu_1$  and  $\mu_2$ ) based on independent samples when both population standard deviations ( $\sigma_1$  and  $\sigma_2$ ) are known. The null hypothesis  $H_0: \mu_1 = \mu_2$  is tested against one of the alternatives below.

- $H_a: \mu_1 \neq \mu_2$
- $H_a: \mu_1 < \mu_2$
- $H_a: \mu_1 > \mu_2$

### **2-Sample t Test (tTest\_2Samp)**

Tests the equality of the means of two populations ( $\mu_1$  and  $\mu_2$ ) based on independent samples when neither population standard deviation ( $\sigma_1$  or  $\sigma_2$ ) is known. The null hypothesis  $H_0: \mu_1 = \mu_2$  is tested against one of the alternatives below.

- $H_a: \mu_1 \neq \mu_2$
- $H_a: \mu_1 < \mu_2$
- $H_a: \mu_1 > \mu_2$

### **1-Prop z Test (zTest\_1Prop)**

Computes a test for an unknown proportion of successes (prop). It takes as input the count of successes in the sample  $x$  and the count of observations in the sample  $n$ . **1-Prop z Test** tests the null hypothesis  $H_0: \text{prop} = p_0$  against one of the alternatives below.

- $H_a: \text{prop} \neq p_0$
- $H_a: \text{prop} < p_0$
- $H_a: \text{prop} > p_0$



This test is useful in determining if the probability of the success seen in a sample is significantly different from the probability of the population or if it is due to sampling error, deviation, or other factors.

### **2-Prop z Test (zTest\_2Prop)**

Computes a test to compare the proportion of successes ( $p_1$  and  $p_2$ ) from two populations. It takes as input the count of successes in each sample ( $x_1$  and  $x_2$ ) and the count of observations in each sample ( $n_1$  and  $n_2$ ). **2-Prop z Test** tests the null hypothesis  $H_0: p_1=p_2$  (using the pooled sample proportion  $\hat{p}$ ) against one of the alternatives below.

- $H_a: p_1 \neq p_2$
- $H_a: p_1 < p_2$
- $H_a: p_1 > p_2$

This test is useful in determining if the probability of success seen in two samples is equal.

### **$\chi^2$ GOF ( $\chi^2$ GOF)**

Performs a test to confirm that sample data is from a population that conforms to a specified distribution. For example,  $\chi^2$  GOF can confirm that the sample data came from a normal distribution.

### **$\chi^2$ 2-way Test ( $\chi^2$ 2way)**

Computes a chi-square test for association on the two-way table of counts in the specified *Observed* matrix. The null hypothesis  $H_0$  for a two-way table is: no association exists between row variables and column variables. The alternative hypothesis is: the variables are related.

### **2-Sample FTest (FTest\_2Samp)**

Computes an F-test to compare two normal population standard deviations ( $\sigma_1$  and  $\sigma_2$ ). The population means and standard deviations are all unknown. **2-Sample FTest**, which uses the ratio of sample variances  $Sx1^2/Sx2^2$ , tests the null hypothesis  $H_0: \sigma_1=\sigma_2$  against one of the alternatives below.

- $H_a: \sigma_1 \neq \sigma_2$
- $H_a: \sigma_1 < \sigma_2$
- $H_a: \sigma_1 > \sigma_2$

Below is the definition for the **2-Sample FTest**.

$Sx1, Sx2$  = Sample standard deviations having  $n_1-1$  and  $n_2-1$  degrees of freedom  $df$ , respectively.

$$F = \text{F-statistic} = \left( \frac{Sx1}{Sx2} \right)^2$$

$df(x, n_1-1, n_2-1)$  = Fpdf( ) with degrees of freedom  $df$ ,  $n_1-1$ , and  $n_2-1$

$p$  = reported  $p$  value

**2-Sample FTest** for the alternative hypothesis  $\sigma_1 > \sigma_2$ .

$$p = \int_F^{\infty} f(x, n_1 - 1, n_2 - 1) dx$$

**2-Sample FTest** for the alternative hypothesis  $\sigma_1 < \sigma_2$ .

$$p = \int_0^F f(x, n_1 - 1, n_2 - 1) dx$$

**2-Sample FTest** for the alternative hypothesis  $\sigma_1 \neq \sigma_2$ . Limits must satisfy the following:

$$\frac{p}{2} = \int_0^{Lbnd} f(x, n_1 - 1, n_2 - 1) dx = \int_{Ubnd}^{\infty} f(x, n_1 - 1, n_2 - 1) dx$$

where:  $[Lbnd, Ubnd]$  = lower and upper limits

The  $F$ -statistic is used as the bound producing the smallest integral. The remaining bound is selected to achieve the preceding integral's equality relationship.

### **Linear Reg t Test (LinRegtTest)**

Computes a linear regression on the given data and a  $t$  test on the value of slope  $\beta$  and the correlation coefficient  $\rho$  for the equation  $y = \alpha + \beta x$ . It tests the null hypothesis  $H_0: \beta = 0$  (equivalently,  $\rho = 0$ ) against one of the alternatives below.

- $H_a: \beta \neq 0$  and  $\rho \neq 0$
- $H_a: \beta < 0$  and  $\rho < 0$
- $H_a: \beta > 0$  and  $\rho > 0$

### **Multiple Reg Tests (MultRegTest)**

Computes a linear regression on the given data, and provides the  $F$  test statistic for linearity.

For more information, see the *TI-Nspire™ Reference Guide*.

### **ANOVA (ANOVA)**

Computes a one-way analysis of variance for comparing the means of 2 to 20 populations. The ANOVA procedure for comparing these means involves analysis of the

variation in the sample data. The null hypothesis  $H_0: \mu_1 = \mu_2 = \dots = \mu_k$  is tested against the alternative  $H_a$ : not all  $\mu_1 \dots \mu_k$  are equal.

The ANOVA test is a method of determining if there is a significant difference between the groups as compared to the difference occurring within each group.

This test is useful in determining if the variation of data from sample-to-sample shows a statistically significant influence of some factor other than the variation within the data sets themselves. For example, a box buyer for a shipping firm wants to evaluate three different box manufacturers. He obtains sample boxes from all three suppliers. ANOVA can help him determine if the differences between each sample group are significant as compared to the differences within each sample group.

### **ANOVA 2-Way (ANOVA2way)**

Computes a two-way analysis of variance for comparing the means of two to 20 populations. A summary of results is stored in the *stat.results* variable.

The two-way ANOVA analysis of variance examines the effects of two independent variables and helps to determine if these interact with respect to the dependent variable. (In other words, if the two independent variables do interact, their combined effect can be greater than or less than the impact of either independent variable additively.)

This test is useful in evaluating differences similar to the ANOVA analysis but with the addition of another potential influence. To continue with the ANOVA box example, the two-way ANOVA might examine the influence of box material on the differences seen.

### **Selecting an Alternative Hypothesis ( $\neq < >$ )**

Most of the inferential stat editors for the hypothesis tests prompt you to select one of three alternative hypotheses.

- The first is a  $\neq$  alternative hypothesis, such as  $\mu \neq \mu_0$  for the **z Test**.
- The second is a  $<$  alternative hypothesis, such as  $\mu_1 < \mu_2$  for the **2-Sample t Test**.
- The third is a  $>$  alternative hypothesis, such as  $p_1 > p_2$  for the **2-Prop z Test**.

To select an alternative hypothesis, move the cursor to the appropriate alternative, and then press **Enter**.

### **Selecting the Pooled Option**

**Pooled (2-Sample t Test and 2-Sample t Interval only)** specifies whether the variances are to be pooled for the calculation.

- Select **No** if you do not want the variances pooled. Population variances can be unequal.
- Select **Yes** if you want the variances pooled. Population variances are assumed to be equal.

To select the **Pooled** option, select Yes from the drop-down list.

## Working with Function Tables

The Lists & Spreadsheet application lets you show a table of function values for any function in the current problem. You can change the settings for the table, delete columns, add values for multiple functions, and edit the expression that defines a function without leaving the Lists & Spreadsheet application.

### Switching to a Table

1. While working in the Lists & Spreadsheet application:

Windows®: Press **Ctrl+T**.

Mac®: Press **⌘+T**.

Handheld: Press  .

The Lists & Spreadsheet application disappears and an empty table is displayed with a list of the functions that are available in the problem.

**Note:** If you have previously shown a table for a function from the Lists & Spreadsheet application, the table includes that function by default.

2. Choose the name of the function for which you want to display values.

Values for the function you selected are displayed in the first column of the table.

3. To move through adjacent cells of the table, press **▲** or **▼**. Press **Tab** to move from the body of the table (cells) to the top two rows (cells for column names and formulas).
4. To hide the table of values and return to the Lists & Spreadsheet application, repeat Step 1.

### Making Changes from a Table

You can change the table of function values using the tools on the **Table** menu.

- ▶ To remove a column from the table, click any cell and click **Delete Column**.
- ▶ To display the list of functions, click a cell in a column and click **Choose**. Select a cell in an empty column unless you are replacing values already displayed. Click a function in the list to add its values to the column.

**Note:** You can also click the drop-down arrow on the top cell of a column to display the list of functions in the problem.

- ▶ To change the expression that defines a function, click **Edit Expression**. You can also edit the expression directly on the entry line beneath the table.

**Note:** When you edit the expression for a function, that function automatically changes in the application used to define the function. For example, if you edit a Graphs & Geometry function in the table, the table values and graph of the function are both updated.

- ▶ To change the default table settings, choose **Edit Table Settings**.

The Table dialog box opens. Press **Tab** to move from field to field and type or select new values for the default table settings:

- **Table Start:** Type the value to use as the first value in the table of values.
- **Table Step:** Type a value for the interval between values.
- **Independent and Dependent:** Click the drop-down arrow to choose **Auto** or **Ask** as the method for populating a column with the values of the independent and dependent variables. **Auto** populates the table starting at the defined table start value and displays an independent and dependent value for each step. **Ask** lets you select a cell and press **Enter** to generate a value for a cell.

# Data & Statistics Application

The Data & Statistics application provides tools to:

- Visualize sets of data in different types of plots.
- Directly manipulate variables to explore and visualize data relationships. Data changes in one application are dynamically applied to all linked applications.
- Explore central tendency and other statistical summary techniques.
- Fit functions to data.
- Create regression lines for scatter plots.
- Graph hypothesis tests and results (z- and t-tests) based on summary statistics definitions or data.

## Adding a Data & Statistics Page

- ▶ To start a new document with a blank Data & Statistics page:

From the main **File** menu, click **New Document**, and then click **Add Data & Statistics**.

Handheld: Press **[on]**, and select **Data & Statistics** .

- ▶ To add a Data & Statistics page in the current problem of an existing document:

From the toolbar, click **Insert > Data & Statistics**.

Handheld: Press **[doc]** and select **Insert > Data & Statistics**.

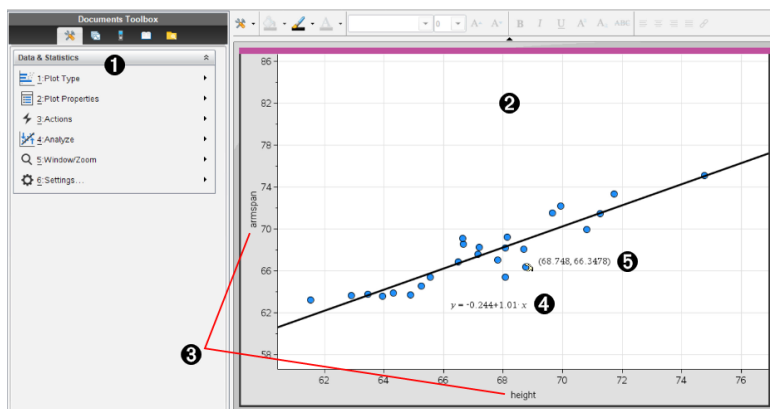

- 1 Data & Statistics menu
- 2 Work area
- 3 Add Variable regions on x-axis and y-axis

- 4 Linear Regression Plot with expression
- 5 Data point with coordinates

## **Basic Operations in Data & Statistics**

The Data & Statistics application lets you explore and visualize data and graph inferential statistics. The Lists & Spreadsheet application can work in conjunction with the Data & Statistics application. The Lists & Spreadsheet Summary Plot and Quick Graph tools automatically add a Data & Statistics application to show plots. A list that you create in a problem (using the Lists & Spreadsheet or Calculator applications) can be accessed as a variable in any TI-Nspire™ application in that problem.

### **Changing Data & Statistics Settings**

1. From the **Settings** menu, select **Settings**.
2. Select the settings that you want to use.
  - **Display Digits.** Lets you select the display format for numeric labels in the current document. Select **Auto** to automatically follow the setting in the Document Settings dialog box.
  - **Diagnostics.** Displays the value of the  $r^2$  or  $R^2$  statistic (when available) under certain regression equations.
    - $r^2$  is displayed for Linear ( $mx+b$ ), Linear ( $a+bx$ ), Power, Exponential, and Logarithmic regressions.
    - $R^2$  is displayed for Quadratic, Cubic, and Quartic regressions.

### **Using the Default Caseplot**

The Data & Statistics application plots numeric and string (categorical) data from variables. When you add a Data & Statistics application to a problem that includes lists, a default caseplot displays on the work area.

The caseplot is like having a stack of cards with information on them and scattering the cards randomly on a table. You can click a dot to see the information on that “card.” You can drag a dot to “group” the “cards” by the caption variable.

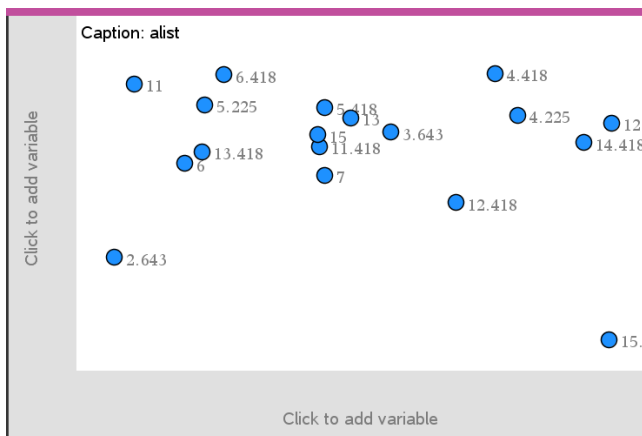

- ▶ Click the variable name displayed after **Caption** to use the caseplot.
  - Choose <None> to remove the default caseplot.
  - Choose the name of a variable to have it replace the current caseplot variable.
  - Hover over any data point to see the summary information.
  - Drag any data point toward an axis to see how the points group.
  - Activate the Graph Trace tool and press ◀ or ▶ to move across points.

When you add a variable to either axis, the plot for that variable replaces the default caseplot. The default caseplot redisplay if you remove the plotted variable from each axis.

### Using the Context Menu

The context menu provides access to the tools most commonly used with the selected object. The context menu displays different options depending on the active object and the task you are performing.

- ▶ To open the context menu for an object.

Windows®: Right-click the object.

Mac®: Hold  $\mathcal{C}$  and click the object.

Handheld: Point to the object and press  .

The context menu includes the **Color** option. You can use the Color option to change the data to the color of your choice.



Other options that are appropriate for various plots also appear on the context menu.

## Selecting Data and Displaying Summary Information

When you hover over part of a plot, the Data & Statistics application displays summary information for the data it represents.

1. Hover at an area of interest in a plot to display data values or summary information. For example, you can hover over the center of a box plot to display the median summary data.
2. Click once to select a representation of data in a plot.

Data points are shown with a bold outline to indicate selection. You can click a point a second time to deselect it, or click additional points to add to the selection.

## Plotting Variables

To plot variables, start with a problem that includes a Data & Statistics application and lists created in the Lists & Spreadsheet application or the Calculator application.

1. Click the Add Variable region near the center of an axis.

If no variable is plotted on the axis, the tooltip **Click or Enter to add variable** displays.

2. Click the tooltip **Click or Enter to add variable**.

A list displays the names of available variables.

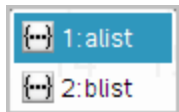

3. Click the name of the variable to plot.

**Note:** By convention, the independent variable is shown on the x-axis.

The default plot for one variable is a dot chart. The data points in the default caseplot reposition to represent the elements of the selected variable in a dot chart.

4. (Optional) Click the Add Variable region near the center of the remaining axis to plot a second variable.

The default plot for two variables is a scatter plot. The data points shift to represent the elements of both variables as a scatter plot.

5. (Optional) Repeat Steps 1-3 to choose additional variables to plot on the vertical axis.

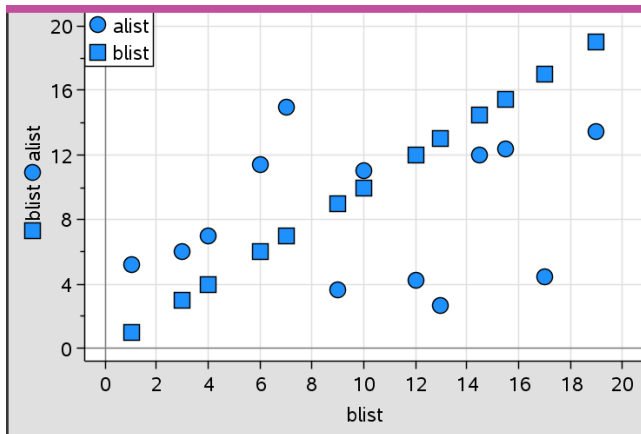

The name of each variable that you add is appended to the label on the axis. The default data point shape changes to help you distinguish data, and a legend is displayed to identify the shapes.

6. Change, analyze, or explore the plotted data.
- Remove or change the variable on an axis by clicking the Add Variable region again.
  - View the plotted data in another supported plot type by selecting a tool from the **Plot Types** menu.
  - Choose the Graph Trace tool on the **Analyze** menu and press ◀ or ▶ to move across the data points in the plot.
  - The lists that you plot as variables can include incomplete or missing cases. (A case is the data contained in a row of cells in the Lists & Spreadsheet application.) The Lists & Spreadsheet application displays a void as an underscore (" \_"), and Data & Statistics plots no data point for a void cell.

### Manipulating Plotted Data

You can manipulate data points on the Data & Statistics work area to explore their effects. For example, you could explore how a specific group of values affects the median.

You can move a data point only in directions allowed by its definition. If a list is defined with a formula in Lists & Spreadsheet, the points in Data & Statistics may not move because of the formula's restrictions. For example, you can manipulate a plot that represents the result of  $y=x$ , but you can only move along a line.

You cannot move points that represent data in a locked variable or data that represents a categorical value.

1. On the Data & Statistics work area, click a representation of data—such as a histogram bin or a whisker of a box plot—that is not locked or restricted by a formula.

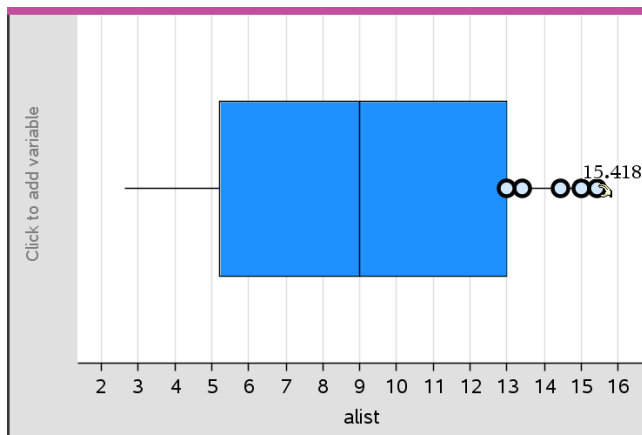

The pointer changes to an open hand to show that the data can be moved.

2. Drag the selection to explore how different values of the point affect the plot.

Handheld: Press **ctrl**  to grab, and then swipe or use the arrow keys to drag.

As you drag, the changing value displays on the work area.

## ***Overview of Raw and Summary Data***

You can create plots directly from raw data or from a summary table.

	A person	B ht	C wt	D eyecolor	E gender	F
1	1	56	130	blue	f	
2	2	55	150	blue	m	
3	3	60	200	green	f	
4	4	62	270	brown	m	
5	5	65	250	brown	f	
6	6	71	187	green	m	
7	7	62	176	brown	m	

Raw data

	A color	B counts	C	D	E
1	blue	3			
2	green	3			
3	brown	4			
4					
5					
6					
7					

Summary table for eye color based on raw data

- Raw data consists of a single list, such as a list of eye colors. When you create a plot of raw data, Data & Statistics counts the occurrences for you. Plotting raw data directly gives you flexibility in analyzing it.
- A summary table consists of two lists, such as eye colors (the X or Y List) and counts of eye-color occurrences (the Summary List). For more information, see *Using Lists & Spreadsheet* chapter.

## Working with Numeric Plot Types

Plots can represent the data from a variable in a variety of ways. Choosing the appropriate plot can help you visualize the data. For example, you may be able to observe the shape and spread of the data in one plot type and another type may be useful for determining the best method for statistically evaluating data.

### Creating Dot Plots

Dot plots, also known as dot-frequency plots, represent one-variable data. Dot plots are the default plot type for numeric data. When you plot a variable as a dot plot, one dot represents each value in the list. Each dot displays on the axis at a point that correspond to the value.

1. To create a dot plot, click the Add Variable region in the center of an axis and click the name of a numeric variable. For more information, see *Plotting Variables*.
2. (Optional) To split a dot plot by category, click the Add Variable region on the other axis and choose the list that contains the corresponding category data.
3. (Optional) To plot multiple dot plots, choose **Add X Variable** on the **Plot Properties** menu and click a numeric variable from the list that displays.

A second dot plot appears on the work area and the name of the plotted variable is added to both axis labels.

4. Explore the plotted data.
  - Hover over a data point to display data values.

- Drag a dot to move it. As you move a point, the values associated with it change on the work area display and in the list for the variable.
- Activate the Graph Trace tool and press ◀ or ▶ to move across the data points in the plot in list order. Points enlarge and display a bold outline as you move across them in Trace mode.

### Creating Box Plots

The Box Plot Tool plots one-variable data in a modified box plot. “Whiskers” extend from each end of the box, either to 1.5 times the interquartile range or to the end of the data, whichever comes first. Points that are a width of  $1.5 * \text{Interquartile Range}$  past the quartiles plot individually, beyond the whiskers. These points are the potential outliers. When no outliers exist, x-min and x-max are the prompt for the end of each whisker.

Box plots are useful for comparing two or more sets of data that use the same scale. If a dataset is large, a box plot can also be useful in exploring data distribution.

1. Click the Add Variable region in the center of an axis. The default plot for one numeric variable is a dot plot. For more information, see *Plotting Variables*.

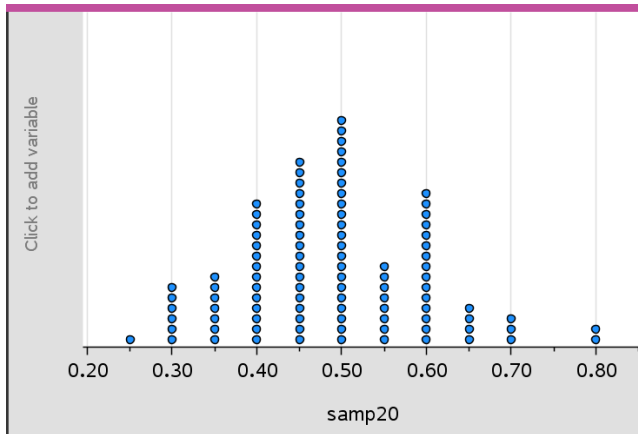

**Note:** If two variables are plotted in the work area, you can create a dot plot by removing one variable. Choose **Remove X Variable** or **Remove Y Variable** from the **Plot Types** menu.

2. On the **Plot Types** menu, click **Box Plot**.

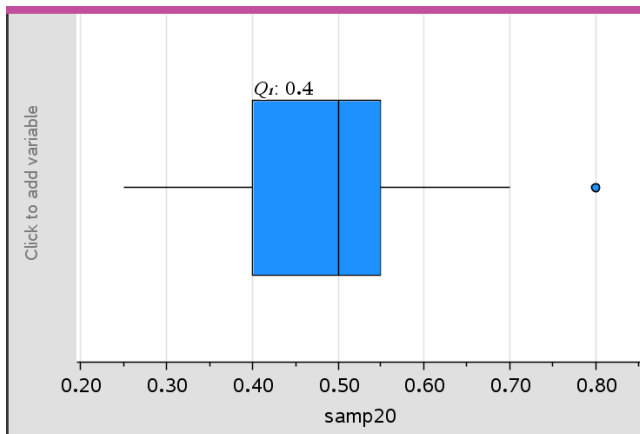

A modified box plot displays on the Data & Statistics work area.

**Note:** You can split a box plot by category by adding a list that contains corresponding categorical data to the y-axis.

- (Optional) To add additional variables for comparing box plots on the same axis, click **Add X Variable** on the **Plot Properties** menu.

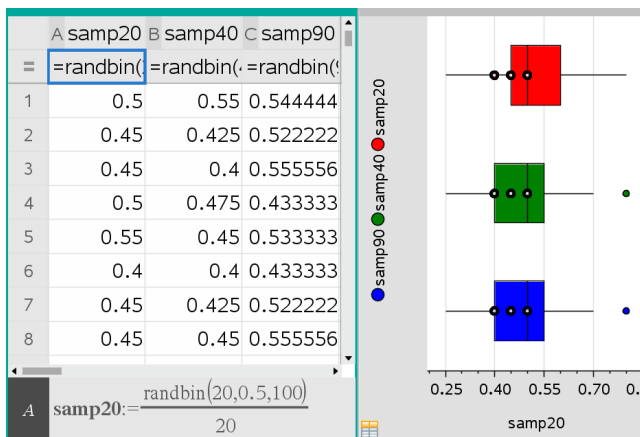

For example, you can use multiple box plots to compare the distributions of sample proportions. In the example, true proportion is .5 and sample size varies from  $n=20$  to  $n=40$  to  $n=90$ .

**Notes:**

- You can create a box plot with frequency by choosing **Add X Variable** or **Add Y Variable** on the **Plot Properties** menu.
  - You can specify a variable multiple times as you choose variables to plot as box plots.
  - The variable used to provide frequency information is added to the label on the horizontal axis in the format:  $x\_variablename\{frequencylist\_name\}$ .
4. Point and click the regions of the box plot to explore and analyze the data it represents.
- Hover over a region or over a whisker to display the details for the portion of the plot that interests you. The label for the quartile that corresponds to your selection is displayed.
  - Click a region of the box plot to select the data points or whiskers. Click again to remove the selection.
  - You can select any box plot that does not include frequency data and choose **Dot Plot** on the context menu to change the plot type.
  - Drag a selection to move it and explore other possibilities for the data.
  - Use the arrow keys to move a data point one pixel at a time.
  - Activate the Graph Trace tool and press ◀ or ▶ to move across dots and regions of the plot. As the trace cursor moves, the values for Q1, the median, Q3, and whisker ends/outliers are displayed.
5. Change the plot from a modified box plot to a standard box plot by choosing **Extend Box Plot Whiskers** on the **Plot Properties** menu.

The box plot is redrawn as a standard box plot with extended whiskers.

The standard box plot's whiskers use the minimum and maximum points in the variable and outliers are not identified. The whiskers on the plot extend from the minimum data point in the set ( $x\text{-min}$ ) to the first quartile (Q1) and from the third quartile (Q3) to the maximum point ( $x\text{-max}$ ). The box is defined by Q1, Med (median), and Q3.

**Note:** You can click **Show Box Plot Outliers** on the **Plot Properties** menu to return to the modified box plot.

## Plotting Histograms

A histogram plots one-variable data and depicts the distribution of data. The number of bins displayed depends on the number of data points and the distribution of these points. A value that occurs on the edge of a bin is counted in the bin to the right.

### Creating a Histogram from Raw Data

1. Create the list that you want to plot as a histogram. For example, you can enter or collect data as a named list on a Lists & Spreadsheet page.

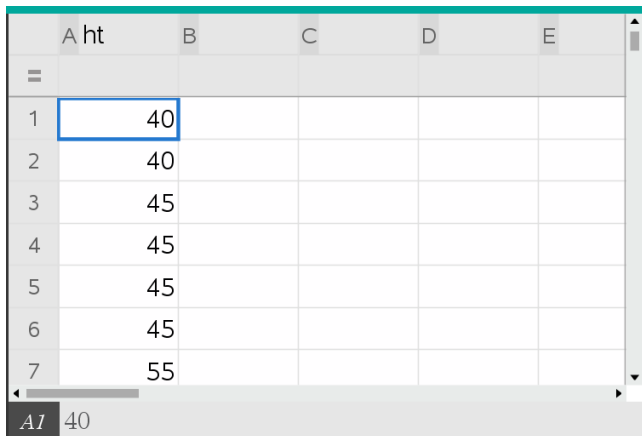

The screenshot shows a spreadsheet with a named list 'ht' in column A. The data points are: 40, 40, 45, 45, 45, 45, 55. The cell A7 containing '40' is selected.

	A ht	B	C	D	E
=					
1	40				
2	40				
3	45				
4	45				
5	45				
6	45				
7	55				

2. On a Data & Statistics page, click the x or y axis, and select your list as the data to plot.
3. From the **Plot Types** menu, click **Histogram**.

The data forms the bins of a histogram, with Frequency plotted by default on the unselected axis.



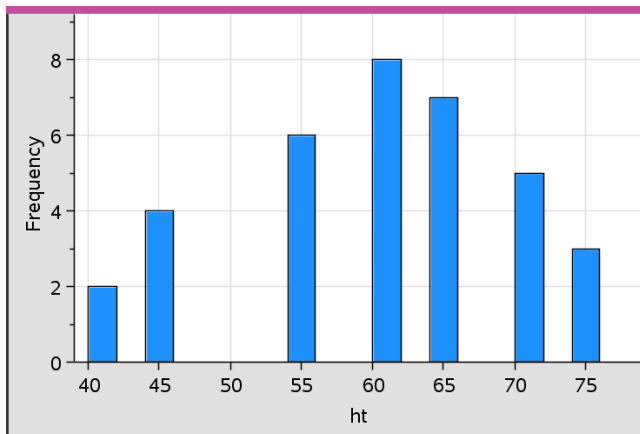

#### 4. Explore the data.

- Hover over a bin to see the information for that bin.
- Click a bin to select it. Click the bin again to deselect it.
- Drag the side of a bin to adjust bin width and number of bins.

**Note:** The bins are not adjustable in categorical plots or plots in which you choose variable bin widths.

- On the **Analyze** menu, click **Graph Trace** and press ◀ or ▶ to cycle through the bins and display their values.

#### ***Adjusting the Histogram Scale of Raw Data***

1. On the **Plot Properties** menu, click **Histogram Properties** and choose **Histogram Scale**.
2. Choose the format for the scale of the histogram.
  - **Frequency** - displays data based upon the number of values that occur within each bin. This is the default data representation.
  - **Percent** - displays data in the histogram by each group's percent value of the whole data set.
  - **Density** - displays data based upon the density of each group within the data set.

## Creating a Histogram with Frequency or Summary Data

1. On a Lists & Spreadsheet page, create two lists: one containing the “bins,” such as heights in a population ( $ht$ ), and the other containing the frequencies of those heights ( $freq$ ).

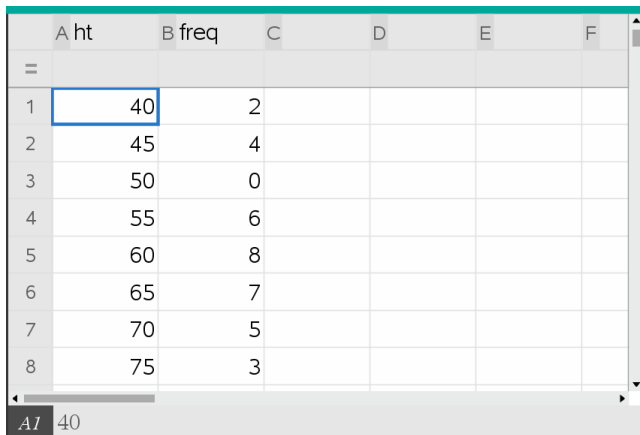

A screenshot of a spreadsheet with two columns: 'ht' and 'freq'. The data is as follows:

	A ht	B freq	C	D	E	F
=						
1	40	2				
2	45	4				
3	50	0				
4	55	6				
5	60	8				
6	65	7				
7	70	5				
8	75	3				

2. On a Data & Statistics page, access the context menu on the x axis, and click **Add X Variable with Summary List**.
3. Select  $ht$  as the X List and  $freq$  as the Summary List.

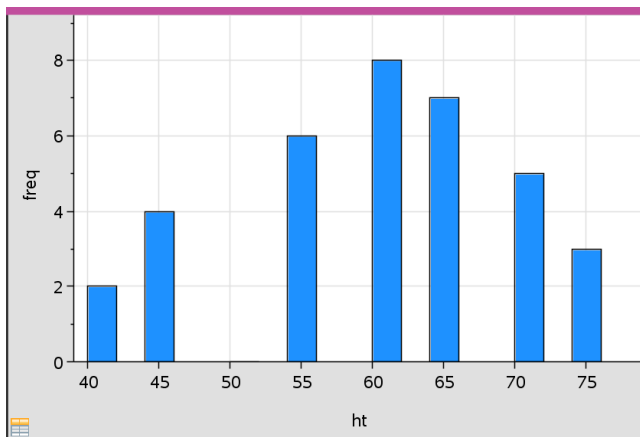

**Note:** It is up to you to set the data and bins in a meaningful way when using summary data.

### Setting Equal Bin Widths

By default, bin widths are set to equal. You can specify the width and alignment of equal-width bins.

1. On the **Plot Properties** menu, click **Histogram Properties > Bin Settings**, and choose **Equal Bin Width**.

The **Equal Bin Width Settings** dialog box opens.

2. Type values to set **Width** and **Alignment** of the bins.
3. Click **OK** to apply the changes and redraw the bins.

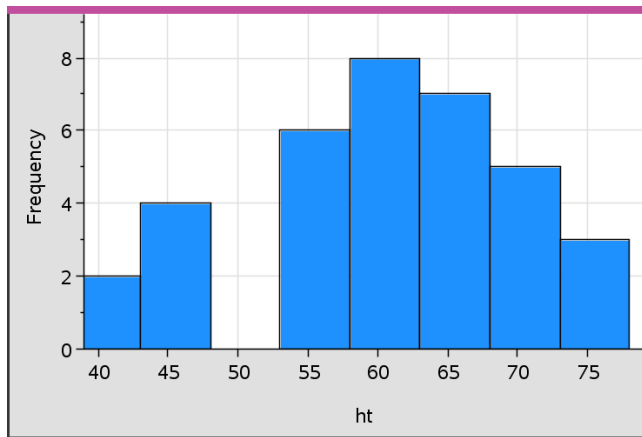

Both the data represented by the bins and the value you type for the alignment affect the placement of bins on the scale.

### Setting Variable Bin Widths

You can set variable bin widths based on a list of bin boundaries.

1. Create a named list containing boundary values.

For example, a boundary list defined as {60,70,100,110} will create bins at 60 to 70, 70 to 100, and 100 to 110.

**Note:** The data must fall within the specified bin widths. For example, a data point of 115 would be outside the bins in the above list, and you would receive a Data/Bin Location Mismatch error.

2. On the **Plot Properties** menu, click **Histogram Properties > Bin Settings**, and choose **Variable Bin Width**.

The **Variable Bin Width Settings** dialog box opens.

3. Select your boundary list as the **List of Bin Boundaries**.
4. Click **OK** to apply the changes and redraw the bins.

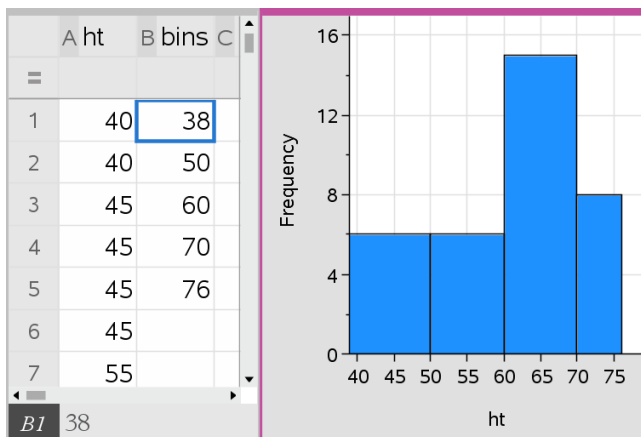

**Note:** You cannot change variable bin widths by dragging their boundaries; you must edit the list of boundaries or restore equal-width bins.

### Creating a Normal Probability Plot

A normal probability plot shows one set of data against the corresponding quartile ( $z$ ) of the standard normal distribution. You can use normal probability plots to judge the appropriateness of the normal model for your data.

1. Choose or create the data you want to use for a normal probability plot. Use a named list from Lists & Spreadsheet or Calculator.
2. Plot the data in one of the following ways:
  - Create a dot plot by selecting a column and choosing **Quick Graph**.
  - Add a Data & Statistics work area. Click the Add Variable region on an axis and click the data list name to plot the variable.
3. On the **Plot Types** menu, click **Normal Probability Plot**.

The data graphs in the Data & Statistics work area. You can examine the graph to compare the normal variable against the quartile.

4. Explore the data represented in the normal probability plot.
  - Hover over a data point to display its value.

- Click to select a data point. Click again to deselect it.
- Click multiple data points to select them.
- Activate the Graph Trace tool and press ◀ or ▶ to move across the data points and display values.

### Creating a Scatter Plot

A scatter plot shows the relationship between two sets of data. You can also plot a scatter plot by using the Quick Graph tool in the Lists & Spreadsheet application.

1. In the Data & Statistics work area, click the Add Variable region and select the variable that contains the data you want to see represented on an axis.

The plot of the selected variable displays on the axis.

2. Click the Add Variable region of the other axis and select the variable containing the data you want to plot.

The data points shift to represent the data in the selected variable.

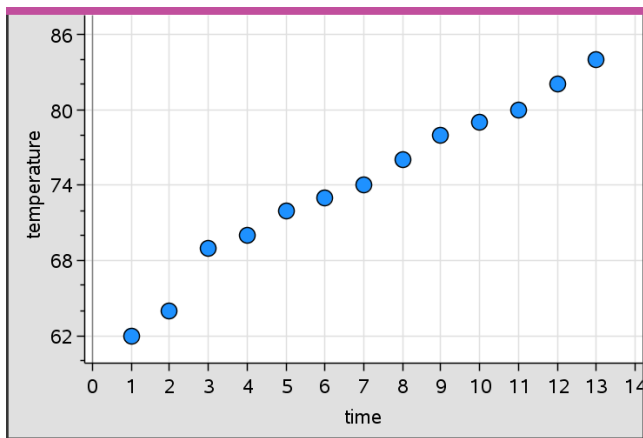

3. Analyze and explore the data in the plot.

- Click a point to select it.
- Hover over a data point to view the summary data.
- Work with the data using the available tools on the **Analyze** menu. For example, choose the Graph Trace tool and press ◀ or ▶ to move across the plot.

- Optional: To plot additional lists against the x-axis, right-click the y-axis and click **Add Variable**.

### Creating an X-Y Line Plot

An X-Y line plot is a scatter plot in which the data points are plotted and connected in order of appearance in the two variables. Like scatter plots, these plots depict the relationship between two sets of data.

By convention, the left-most column of data is represented on the horizontal axis.

- Create a scatter plot. For more information, see *Creating a Scatter Plot*.
- On the **Plot Types** menu, click the **XY Line Plot** tool.

The data points within each set are connected to each other by a line.

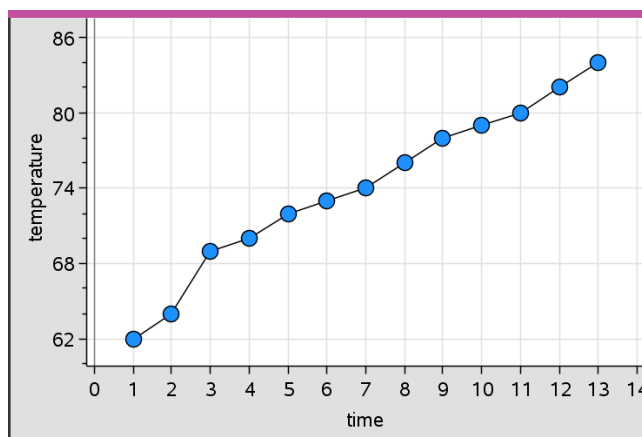

**Note:** The dots are connected in the order that they appear in the list variable on the horizontal axis. To change the order, use the sort tool in Lists & Spreadsheet.

- Analyze and explore the data in the plot.
  - Hover over a data point to view the summary data.
  - Work with the data using the available tools on the **Analyze** menu. For example, choose the Graph Trace tool and press the arrow keys to move across the dots in the plot and view the values.

### Working with Categorical Plot Types

You can sort and group data using the categorical plot types:

- Dot Chart

- Bar Chart
- Pie Chart

The categorical plot types can be used to compare the representations of data across different plots. When the same variable (list) is used for a dot chart and a bar chart or pie chart in a problem, selecting a data point or segment in one of the plots selects the corresponding data point, segment, or bar in all other plots that include the variable.

### Creating a Dot Chart

The default plot type for categorical data is the dot chart.

When one variable is plotted, the value of each cell is represented as one dot, and the dots are stacked at the point on the axis that corresponds to the cell value.

1. In Lists & Spreadsheet, create a spreadsheet that includes at least one column of string values that can be used as categories for data.

	A breed	B walk_time_min	C	D	E
1	Toy Poodle	12			
2	Lhasa Apso	18			
3	Beagle	18			
4	Beagle	15			
5	Beagle	12			
6	Cocker Spaniel	20			
7	Doberman	18			
8	Doberman	20			
9	Pit Bull	20			

**Note:** To type a string in Lists & Spreadsheet, enclose the characters in quotes.

2. Add a Data & Statistics page to the problem.

Notes:

- You can also use the Lists & Spreadsheet Quick Graph tool to automatically add a Data & Statistics page and plot the selected column.
- The new Data & Statistics work area displays a default caseplot with a caption, variable name, and unplotted data points for the variable. You can click the variable name in the caption to choose another variable for previewing, or drag a default data point toward an axis to plot the current variable.

3. Move near the center of either axis and click the Add List region. The list of variables displays.

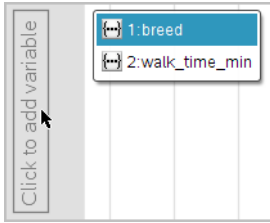

4. Click the list that contains the categories you want to use for sorting data.



A dot chart plots in the work area. The application labels the axis with the variable name and shows a dot for each instance of a category.

5. Explore the plotted data.
  - Hover over a dot in the plot to display data values.
  - Click a dot to select it. Click the dot a second time to deselect it or remove it from a selection of multiple dots.
  - Activate the Graph Trace tool and press ◀ or ▶ to move across the points in list order. Dots display a bold outline as you move across them in Trace mode.

### Creating a Bar Chart

Like dot charts, bar charts display categorical data. The length of a bar represents the number of cases in the category.



1. Click the **Add Variable** region of either axis and choose the name of a categorical variable. For more information, see *Creating a Dot Chart*.
2. On the **Plot Types** menu, click **Bar Chart**.

The dot chart changes to a bar representation of the data.

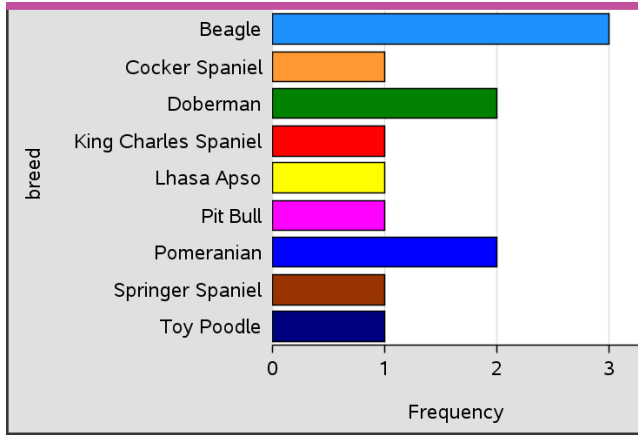

3. Explore the data in the plot.
  - Hover over a bar to see a category summary (the number of cases and percentage among all categories).
  - Activate the **Graph Trace** tool and press ◀ or ▶ move across the bars and view summary information.

### Creating a Bar Chart from a Frequency Table or Summary Data

1. On a new **Data & Statistics** page, create a bar chart with frequency or summary data by choosing **Add X Variable** on the **Plot Properties** menu.

**Note:** You can also create a bar chart with frequency by selecting **Add Variable with Summary List** from the context menu of the **Add Variable** region of an axis.

2. Select the desired variable from the pop-up choices.
3. Set the height of the bars with the summary variable by selecting **Add Summary List** from the **Plot Properties** menu.
4. Select the summary list from the pop-up choices.

The bar chart plots on the work area. The icon in the lower left corner indicates that this plot was generated from summary data.

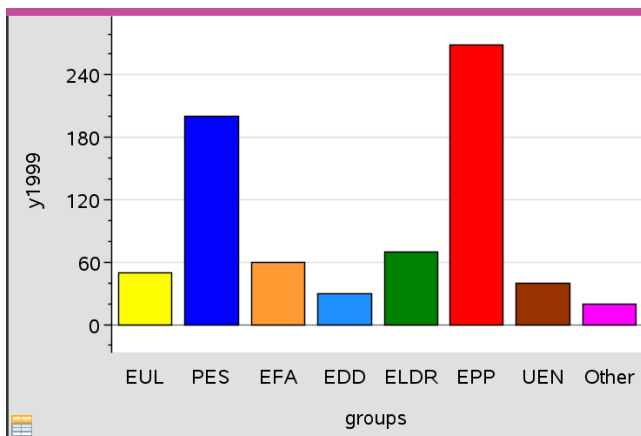

5. Hover over a bar to see a category summary, or use the Graph Trace tool on the **Analyze** menu to move across all of the bars displaying the summaries.
6. (Optional) Add summary lists to create a comparative bar chart.

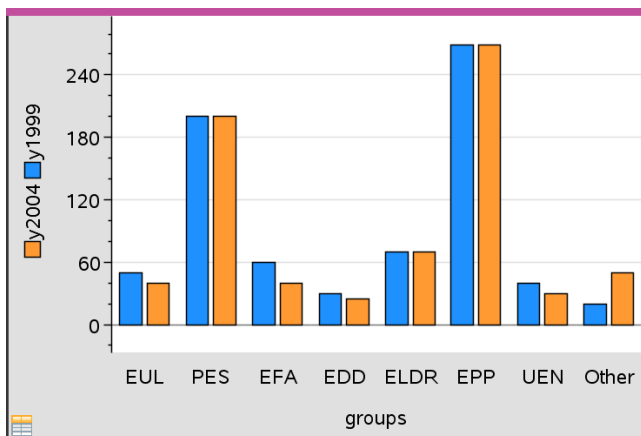

### Creating a Pie Chart

A pie chart represents categorical data in a circular layout and uses an appropriately proportioned segment for each category.

1. Create a dot chart on the work area.
2. On the **Plot Types** menu, click **Pie Chart**.

The dots move by category into the segments of the pie chart.

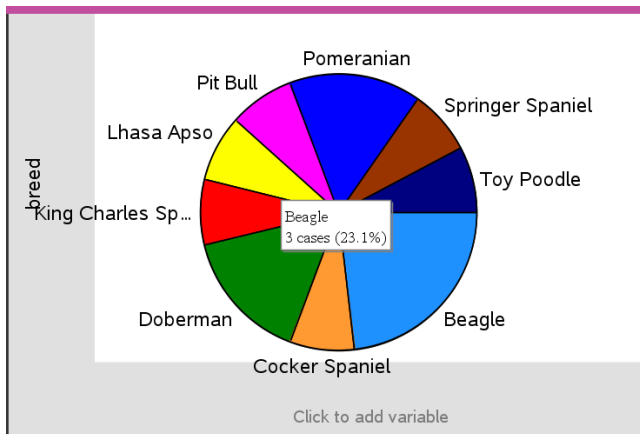

3. Hover over a segment to see the summary for the category, or use the Graph Trace tool on the **Analyze** menu to move across each segment displaying all of the summaries. The summary shows the number of cases for the category and the percentage among all cases.

**Note:** You can switch to a pie chart from a bar chart generated from summary data.

### Creating a Comparative Bar Chart

This might be used to explore data in a two-way table.

1. Type the raw data on a Lists & Spreadsheet page.

	A person	B ht	C wt	D eyecolor	E gender	F
=						
1	1	56	130	blue	f	
2	2	55	150	blue	m	
3	3	60	200	green	f	
4	4	62	270	brown	m	
5	5	65	250	brown	f	
6	6	71	187	green	m	
7	7	62	176	brown	m	

E1 f

2. From the **Insert** menu in the toolbar, click **Data & Statistics**.

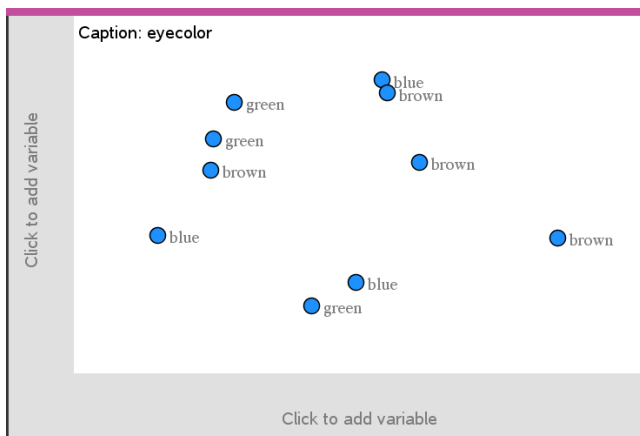

**Note:** Your screen may differ, depending on the data you entered.

3. Select the **Click to add variable** field, and select **eyecolor** as the variable for the x axis.
4. On the **Plot Type** menu, click **Bar Chart**.

The frequency of the eyecolor data is plotted.

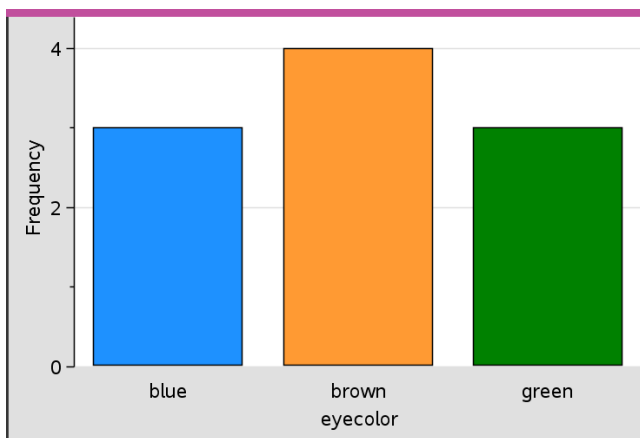

5. To split the eyecolor data by gender, click the **Plot Properties** menu, click **Split Categories by Variable**, and then click **gender**.

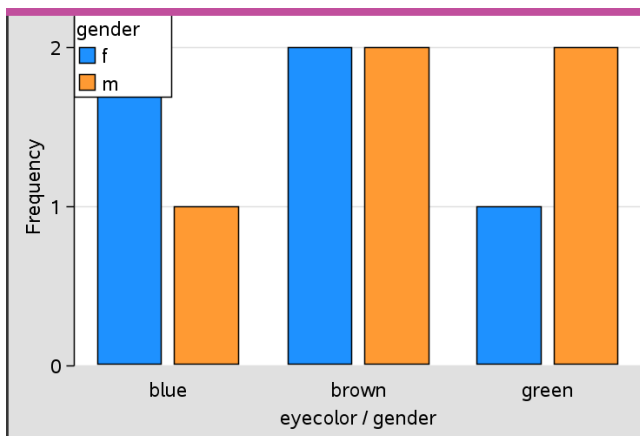

### Splitting a Numeric Plot by Categories

You can use a categorical split to sort the values plotted on an axis.

1. Open a problem that includes a Lists & Spreadsheet page, or create data to be plotted in the Lists & Spreadsheet application.

In this example, lists contain dog breed and daily walk information.

	A breed	B walk_time_min	C	D	E
=					
1	Toy Poodle	12			
2	Lhasa Apso	18			
3	Beagle	18			
4	Beagle	15			
5	Beagle	12			
6	Cocker Spaniel	20			
7	Doberman	18			
8	Doberman	20			
9	Pit Bull	20			

2. Click column letter (B).
3. On the Lists & Spreadsheet **Data** menu, click the **Quick Graph** tool.

The Quick Graph tool adds a Data & Statistics page. Data & Statistics plots the variable and labels the horizontal axis.

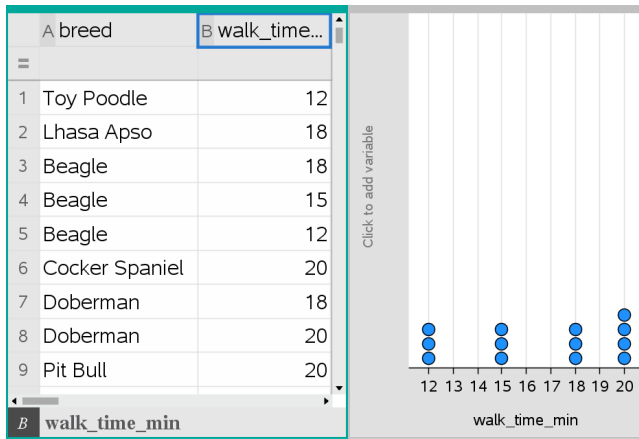

4. To plot the numeric data for each category, hover on the Add Variable region near the center of the vertical axis and click the tooltip **Click or Enter to add variable**.

The list of available variables displays.

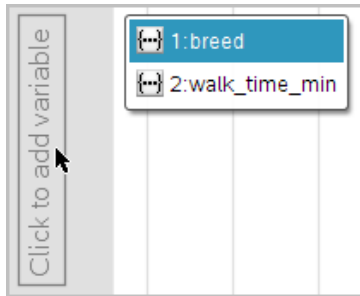

5. On the list of variables, click the name of the category variable.

Data & Statistics labels the vertical axis and plots the numeric data for each category.

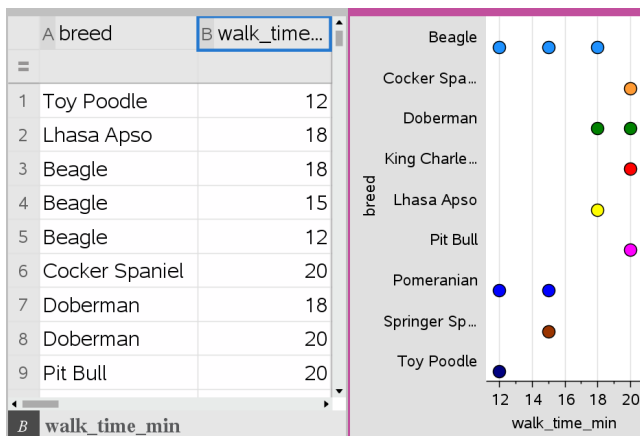

## Exploring Data

You can manipulate and explore plotted data.

### Moving Points or Bins of Data

1. Click and hold the desired point or bin.

The pointer changes to an open hand .

2. Drag the point or bar to the new location and release it. Moving the point changes the values for x and y.

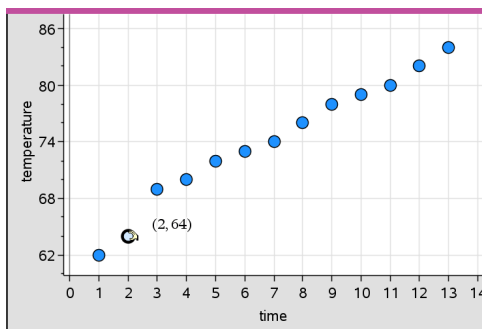

If you are working with data from Lists & Spreadsheet, the data that corresponds to the original point or bar automatically updates in the original column(s) in Lists & Spreadsheet as you move the point.

You can also move points or bins by changing the numbers in the Lists & Spreadsheet or Calculator applications. Data will update in all of the representations.

### Moving Multiple Points

1. Position the pointer over each data point that you want to select. When the pointer changes to an open hand , click to add the point to the selection.

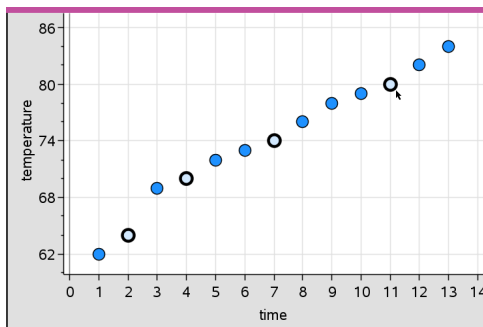

Alternatively, you can drag a selection rectangle around the points to select them.

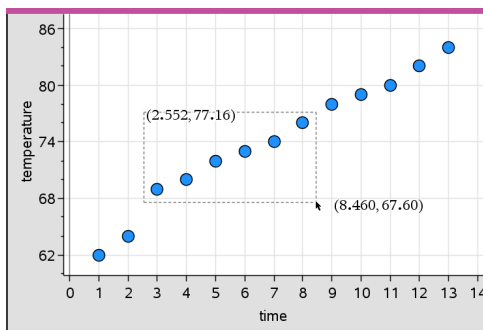

2. Drag any of the selected points to move them all.

**Note:** When a list is defined in Lists & Spreadsheet as a formula, the movement of points is restricted to positions that satisfy the formula.

### Sorting Plotted Categories

You can sort plotted categories in list order, value order, or alphabetically by category name.

1. Click the work area that contains the plotted data.



2. On the Actions menu, click Sort, and then click the type of sort.

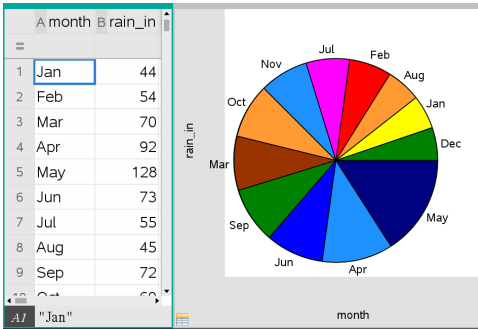

Months listed chronologically but sorted by value (amount of rainfall)

**Note:** You can customize the order of the categories by clicking a label and dragging it.

### Plotting a Value

You can plot a value on an existing plot. It displays as a vertical line in the work area.

1. From the **Analyze** menu, click **Plot Value**.

A text box with a default expression opens in the work area.

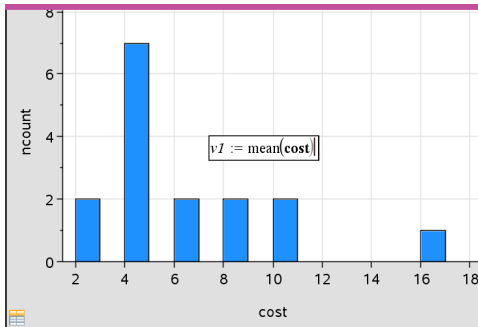

2. Type the value you want to plot, and press **Enter**. In this example, the value is `v1:= mean(cost)`.

The line is drawn at that value, perpendicular to the axis. If you have multiple plots on the work area, a plot value segment displays for each plot.

**Note:** If you use a frequency table to generate a histogram, reference the frequency list in your expression. For example, type the expression "v1:= mean(List, FreqList)" in the plot value entry box.

3. Click the line to display the value.

**Note:** Double-click the value to edit the expression.

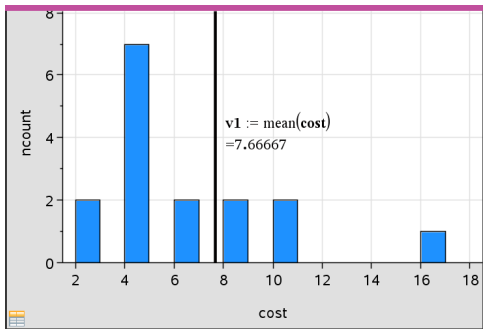

*Plot value with value displayed*

You can use Plot value for a single number or any expression that evaluates to a number. If the value is dependent on the data, like **mean**, when you drag a point or make changes in the Lists & Spreadsheet application, the line updates to reflect the change, allowing for investigation of the influence of points on the calculation.

### Removing a Plotted Value

1. Select the plotted value line.
2. From the **Actions** menu, click **Remove Plotted Value**.

### Changing the Plot Type

You can change the plot type, to view different representations of data.

- On the **Plot Type** menu, click a new plot type. Only the supported plot types are available. For example, only univariate plot types are available when a single variable plotted on an axis.

The data representation changes to the new plot format.

**Note:** Options are unavailable on the menu if the plotted data cannot be represented by the plot type. For example, if a scatter plot is displayed in the work area, you cannot create a box plot without first removing the variable from the y-axis.

## Rescaling a Graph

You can change the scale of the axes by using Translation and Dilation. The pointer changes to indicate whether Translation ( $\oplus$ ) or Dilation ( $\oplus$ ) is available in zones on the axes.

### Translation

A translation slides a set of axes a fixed distance in a given direction. The original axes have the same shape and size.

1. Position the pointer over a tic mark or label in the middle third of the axis. The pointer changes to  $\oplus$ .

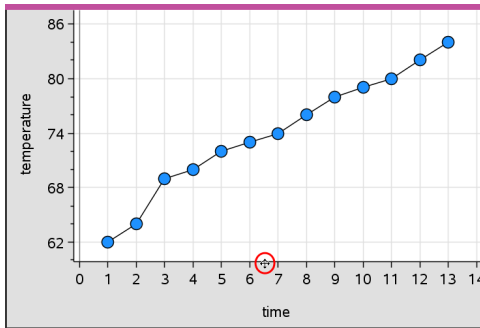

2. Click to grab. The pointer changes to a grasping hand  $\text{✋}$ . Drag to the desired position and release.

### Dilation

Dilation retains the shape of the axes, but enlarges or reduces the size.

1. Position the pointer over a tic mark or label near the ends of the axis. The pointer changes to  $\oplus$  on the vertical axis or  $\oplus$  on the horizontal axis.

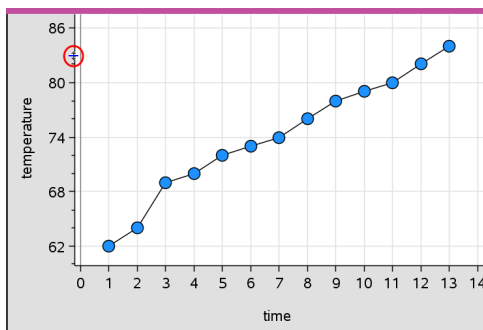

- Click to grab. The pointer changes to an open hand . Drag to the desired position and release.

### Adding a Movable Line

You can add a movable line to a plot. Moving and rotating the line on the work area changes the function that describes it.

- From the **Analyze** menu, click **Add Movable Line**.

The movable line displays and is labeled with a function that describes it. For this example, Data & Statistics stores the expression for the movable line in the variable *m1*.

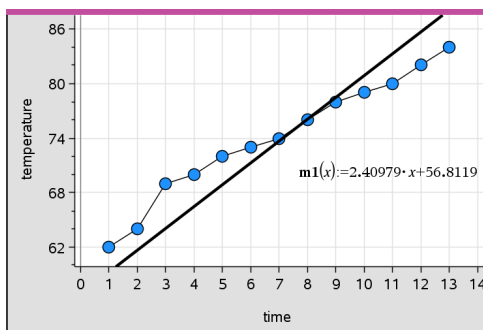

### Rotating a Movable Line

- Click and grab either end of the line.

The pointer changes to .

- Drag to rotate and change the slope of the line.

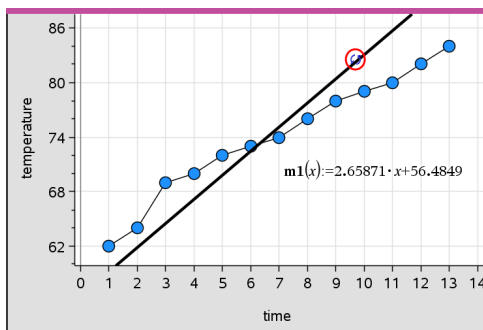

The function  $m1(x)$  is updated for the changes in the position of the movable line.

### Changing the Intercept

1. Click in the middle of the movable line.

The pointer changes to  $\oplus$ .

2. Drag to change the intercept.

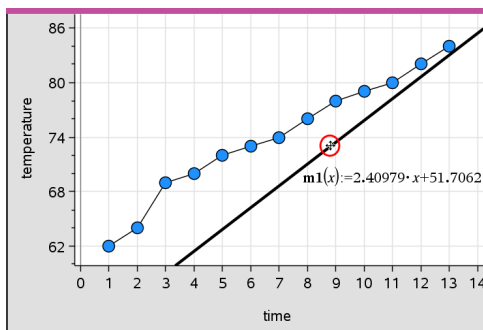

The number at the end of the equation changes to show the change in the intercept.

**Note:** The movable line is stored as a function that can be used for prediction in the Calculator application.

### Locking the Intercept at Zero

You can lock the intercept of the movable line at zero.

- From the **Analyze** menu, click **Lock Intercept at Zero**.

You can unlock the intercept by choosing **Unlock Movable Line Intercept** on the **Analyze** menu.

### Tracing a Movable Line

You can trace a movable line to predict and analyze values.

1. Click the line.

The pointer changes.

2. From the **Analyze** menu, click **Graph Trace** to enable Trace mode for the line. Rotation of the line is not supported in Trace mode.
3. Press ◀ or ▶ (left or right arrow keys) to trace the movable line.

If the plotted variables change, points on the graph and the line are updated automatically.

### Showing a Line of Regression

You can show a line of regression when you have a scatter plot or an X-Y line plot on the work area. Studying the line of regression can help you understand the relationship between two variables.

1. With a scatter plot or X-Y line plot of two variables on the work area, click the **Analyze** menu, choose **Regression** and view the list of regressions.
2. Click the type of regression line to show. For example, choose **Show Linear (mx+b)** to plot a linear regression line as shown in the following example.

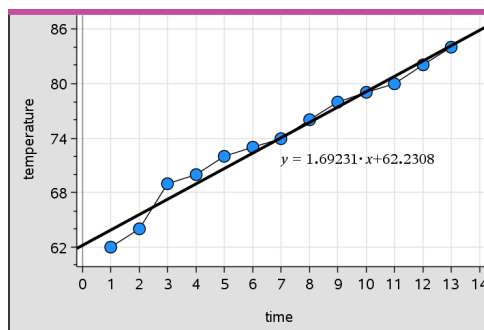

When the line of regression is selected, the expression for the line displays.

## Showing Residual Squares

You can display residual squares on a plot. Residual squares can help you assess the appropriateness of the model for your data.

**Note:** This tool is only available when a regression or movable line is present in the work area.

- From the **Analyze** menu, click **Residuals** > **Show Residual Squares**.

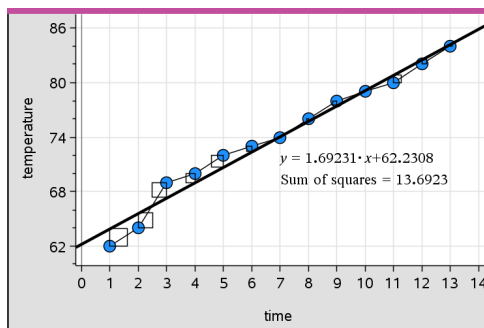

The sum of squares is updated as the line or data changes.

## Showing a Residual Plot

You can show a residual plot to determine how well a line fits data. The work area must include a scatter plot and one or more movable lines, regressions, or plotted functions for **Show Residual Plot** to be available.

- With a scatter plot, line of regression, and/or movable line in the work area, click the **Analyze** menu, and click **Show Residual Plot** > **Residuals**.

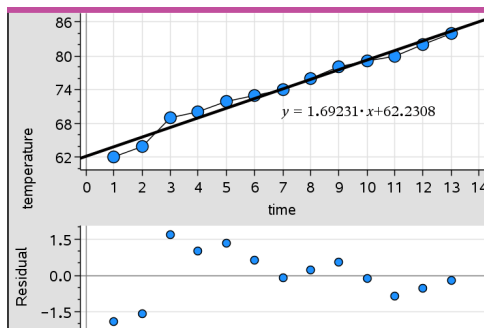

**Notes:**

- With multiple regressions or functions and movable lines plotted, you can select each by clicking the line to show its residual plot.
- Click and hold a dot on the residual plot to see the residual.
- The residual plot for the selected regression or function displays in the work area.
- For consistency in comparing sets of data, residual plots do not rescale when you move from one function or regression to another.
- Select a function or regression before a showing residual plot. If no function or regression is selected and there are several plotted, Data & Statistics arbitrarily selects the function or regression for showing the residual plot.
- Axes can be adjusted by clicking and dragging.

### Removing a Residual Plot

- ▶ With a scatter plot, line of regression, and/or movable line in the work area, click the **Analyze** menu, and click **Hide Residual Plot**.

### Using Window/Zoom Tools

Use the Window/Zoom tools to redefine the graph to better view points of interest. The Window/Zoom tools include:

- **Window Settings:** displays a Window Settings dialog box that lets you type the x-min, x-max, y-min, and y-max values for the axes.
- **Zoom - Data:** adjusts the zoom factor to display all plotted data.
- **Zoom - In:** lets you define the center point of the zoom in location. The Zoom In factor is approximately 2.
- **Zoom - Out:** lets you define the center point of the zoom out location. The Zoom Out factor is approximately 2.

### Using the Window Settings Tool

1. On the **Window/Zoom** menu, click **Window Settings**.

The **Window Settings** dialog box opens. The current values for x-min, x-max, y-min, and y-max are displayed in the fields.

**Note:** Only the appropriate boxes are editable, depending on whether there are one or two axes in the work area.

2. Type the new values over the old values.
3. Click **OK** to apply the changes and redraw the plot.

### Using the Zoom Data Tool

- ▶ On the **Window/Zoom** menu, click **Zoom Data**.

The work area rescales to display all plotted data.



### Using the Zoom In Tool

1. On the **Window/Zoom** menu, click **Zoom In**.
2. In the work area, click the center point of the area of interest. This will be the center of the zoom in action.

The plot redraws to focus and enlarge the portion of the plot centered about the point you selected in the previous step.

### Using the Zoom Out Tool

1. On the **Window/Zoom** menu, click **Zoom Out**.
2. In the work area, click the center point of the area of interest. This will be the center of the zoom out action.

The plot redraws to display a larger portion of the plot, centered about the point you selected in the previous step.

## Graphing Functions

You can graph functions by typing them in Data & Statistics, or you can graph functions defined in other applications.

### Graphing Functions Using the Plot Function Tool

You can use the Plot Function tool to plot functions in a work area that already includes a plot on the axes. Plot Function lets you specify and graph a function for comparison to an existing plot.

To use the Plot Function tool:

1. Create or open a problem that includes variables (from Lists & Spreadsheet) that are plotted on a Data & Statistics work area. Ensure that your work area contains both a horizontal axis and a vertical axis scale.
2. From the **Analyze** menu, click **Plot Function**.

A function entry field displays in the work area.

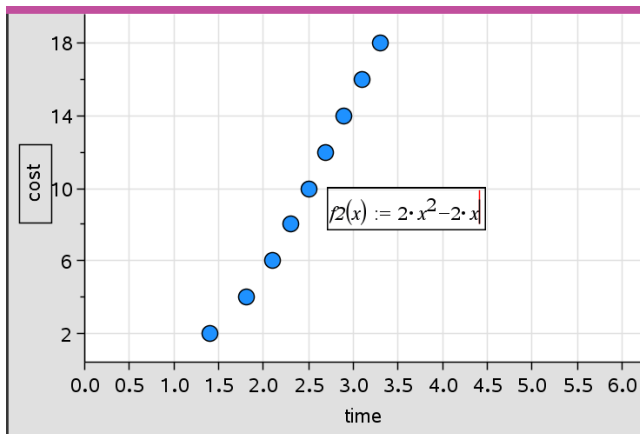

**Note:** You can edit the function's expression typed in the entry field. However, the function graphed in Data & Statistics cannot be manipulated or moved around the work area. To do that, use Graphs & Geometry.

3. Type the function in the entry field, and press **Enter**.

**Note:** You can rename the function by typing over  $f1(x)$ : with another name, if you choose.

The function graphs in the work area and is saved as a variable for use in other applications.

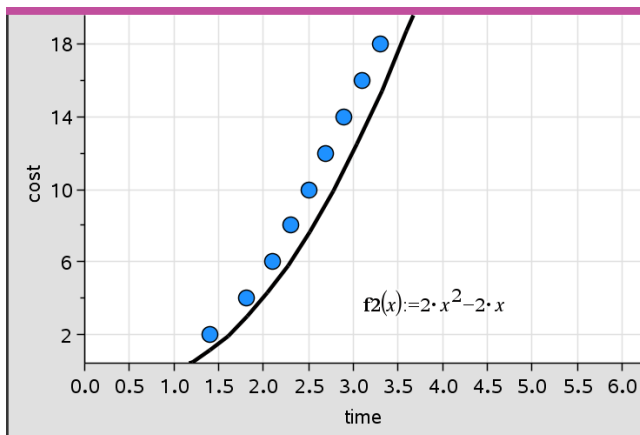

## Entering Functions from Other Applications

You can enter a function that has been defined as a variable in another application, such as Lists & Spreadsheet, Graphs & Geometry, or Calculator.

1. Add a variable to each axis. You can access any variables defined in a Lists & Spreadsheet or Calculator application in your problem from the variable list.
2. From the **Analyze** menu, click **Plot Function**.

A function entry field displays in the work area.

$$f1(x) :=$$

3. Click  on the toolbar.

Handheld: Press .

A list of variables available in the problem displays.

4. Click to select the variable containing the function you want to plot.

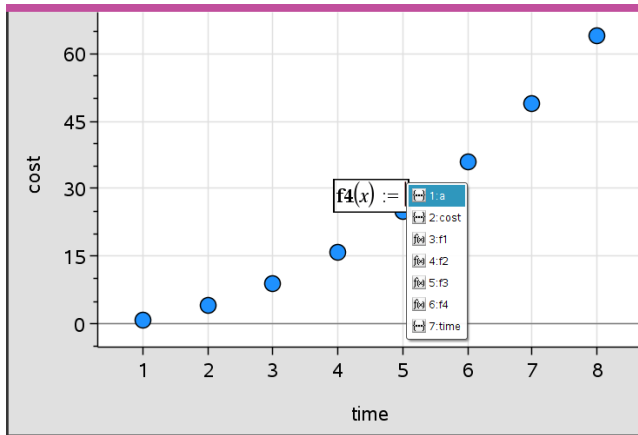

In the example below, the variable  $a$  contains the function  $f(x)=x^2$ .

5. Press **Enter**.

The function plots in the work area.

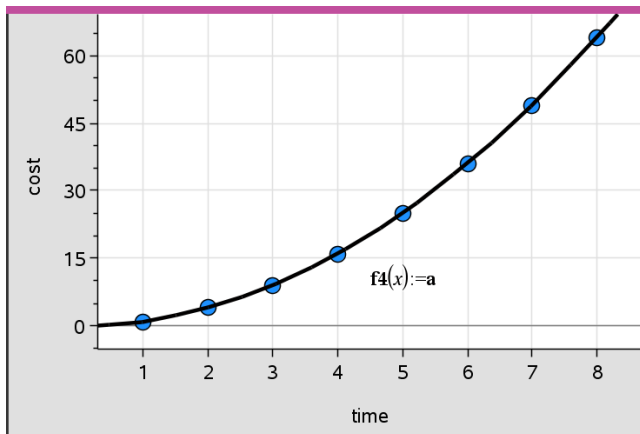

### Editing a Function

You can edit a function and update it in the work area.

1. You can edit a function by double-clicking the equation and then making changes as required.
2. Press **Enter** after making all changes and the updates are displayed in the work area.

### Using Data & Statistics Functions in other Applications

Data & Statistics functions are stored as variables, and may be used in other applications, in the same manner as any other variable. Support for all function types is included.

**Note:** Function numbers increment to use the next available. If you have defined  $f_1(x)$  and  $f_2(x)$  in Graphs & Geometry, the first function you create in Data & Statistics will be  $f_3(x)$ .

### Using Show Normal PDF

You can approximate data plotted in the Data & Statistics work area against the normal probability density function. The tool overlays the normal probability density function using the mean and the standard deviation of the data in the histogram.

To show the normal probability density function for plotted data:

1. Add a variable to the x-axis.
2. On the **Plot Types** menu, click **Histogram**.

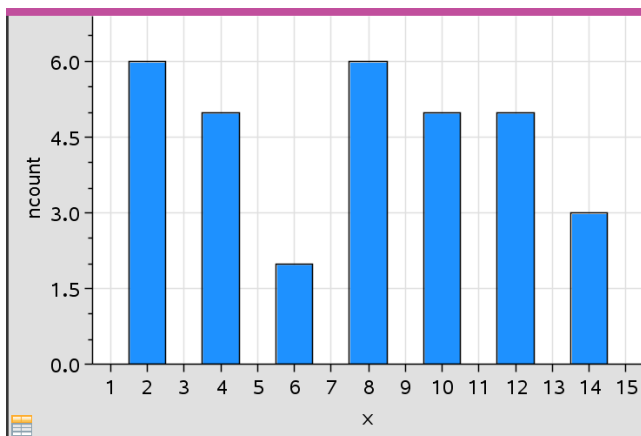

**Note:** Show Normal PDF is available only when histogram is the plot type.

- From the **Analyze** menu, click **Show Normal PDF**.

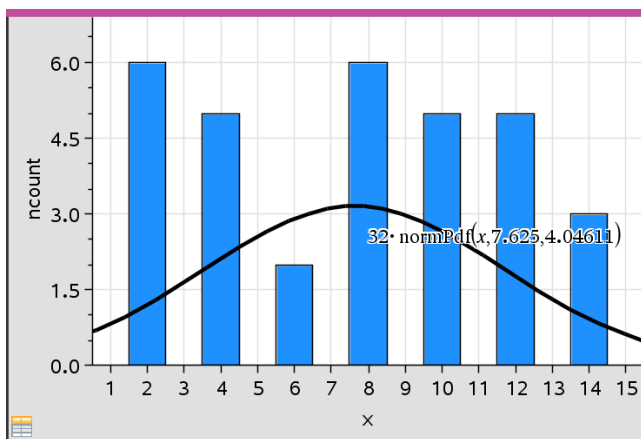

The normal PDF for the graph plots in the work area. The expression used to calculate the PDF displays when selected.

You can click **Hide Normal PDF** on the **Analyze** menu to remove the PDF.

### Using Shade Under Function

Use **Shade Under Function** to find the area of a selected region under a function graphed in the work area.

1. Select any function graphed in the Data & Statistics work area. For example, select a previously graphed normal PDF.
2. From the **Analyze** menu, click **Shade Under Function**.

The pointer becomes a dotted vertical line and the boundary  $\pm \infty$  displays when you position the mouse near the boundary on the left or right. You can click when  $\infty$  displays to set it as a boundary.

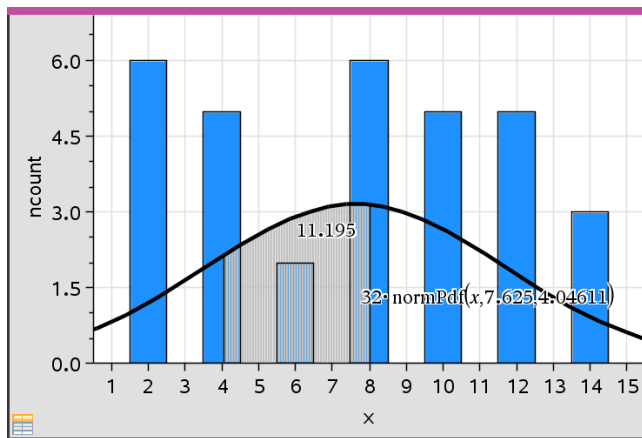

3. Select a point on the curve and click to indicate where to start shading under the function. The direction in which you move next determines whether the region shaded is on the left, right, or center of the curve.
4. Select a point on the curve and click to indicate the end boundary of the shaded area. A region under the function is shaded based on the points you selected.

You can work with Shade Under Function in the following ways:

- Select the region to display the values for data points in the shaded area.
- To remove the shading, right-click or **Ctrl-click** the shaded region and choose **Remove Shaded Region**.
- To change the fill color of the shaded area, right-click or **Ctrl-click** the shaded region, choose **Color**, choose **Fill**, and click a color.
- Use plot value to set the boundary to an exact number. When a boundary for shading is set to a plotted value, you can change the plotted value to update the shading.
- Edit a shaded region by clicking and dragging the edge at the starting or ending boundary.

## Using Graph Trace

Graph Trace lets you move from one point on a graph to another to analyze variations in the data. You can use Graph Trace mode to explore the data for the following graphs.

- Graphs from Plot Function and Show Normal PDF
- Distribution curves (created in the Lists & Spreadsheet application)
- Movable Lines
- Regressions
- Caseplots
- Dot plots
- Scatter plots and X-Y line plots
- Box plots
- Histograms
- Bar charts
- Pie charts

### To use Graph Trace

1. From the **Analyze** menu, click **Graph Trace**.
2. Press ◀ or ▶ to move across the plot.

The data representations enlarge and appear with a bold outline as you move across them in Trace mode.

## Customizing Your Workspace

### Working with Color

All data points for a plotted variable display in the same color to distinguish them from the data points of other variables. Data plotted by category and split plots are automatically displayed in different colors to help you distinguish the data.

To emphasize or distinguish certain parts of your work, you can change the default color for a variable's data.

- Apply fill colors to objects, such as shading, or change the color for a variable's data points.
- Apply color to plotted lines (such as lines of regression) or movable lines.

### Inserting a Background Image

When using the computer software, you can insert an image as a background for a Data & Statistics page. The file format of the image can be .bmp, .jpg, or .png.

1. From the **Insert** menu, click **Image**.
2. Navigate to the image that you want to insert.
3. Select it, and then click **Open**.

The image is inserted as a background.

For more information, see the *Working with Images* chapter.

## Working with Text

The Insert Text tool lets you type text to describe details related to plots on the work area.

1. From the **Actions** menu, click **Insert Text**.

A text box opens.

2. Type notes or descriptions in the text box.

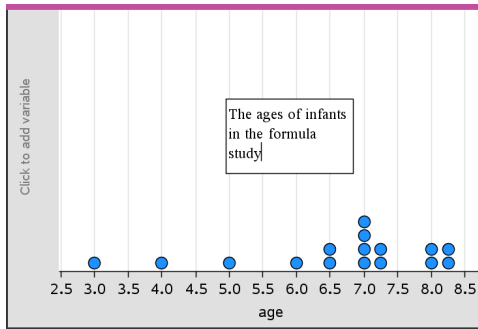

3. Customize the text to suit your needs.
  - Move the pointer over the edges of the text box to drag the borders and change the width or height.
  - Click and grab the text box to move it near objects that relate to the text.
  - Scroll to view additional text in a box by clicking the arrows at the top and bottom edge.
  - Click outside of the text entry box to exit the Text tool.
  - Hide text by clicking the **Actions** menu and clicking **Hide Text**.
  - Change the color of text.



## Adjusting Variable Values with a Slider

A slider control lets you interactively adjust or animate the value of a numeric variable. You can insert sliders in the Graphs, Geometry, Notes, and Data & Statistics applications.

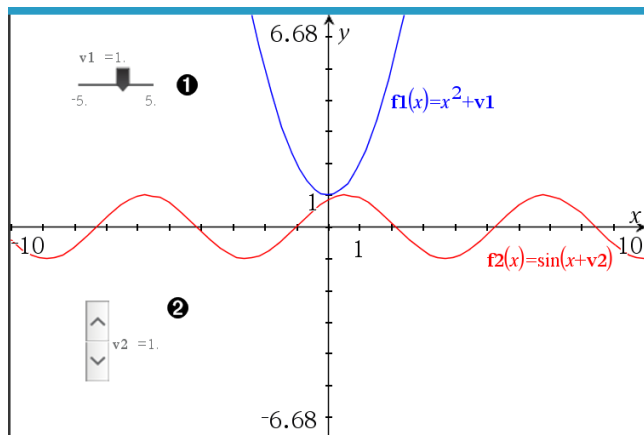

- 1 Horizontal slider for adjusting variable  $v1$ .
- 2 Minimized vertical slider for adjusting variable  $v2$ .

**Note:** TI-Nspire™ version 4.2 or higher is required for opening .tns files containing sliders on Notes pages.

### Inserting a Slider Manually

1. From a Graphs, Geometry, or Data & Statistics page, select **Actions > Insert Slider**.

—or—

From a Notes page, make sure the cursor is not in a math box or chem box, and then select **Insert > Insert Slider**.

The Slider Settings screen opens.

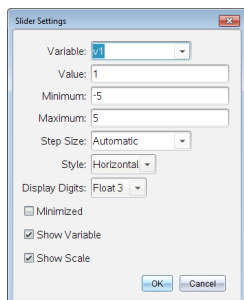

2. Enter the desired values, and click **OK**.

The slider is displayed. On a Graphs, Geometry, or Data & Statistics page, handles are displayed to let you move or stretch the slider.

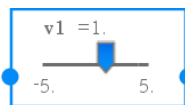

To remove the handles and use the slider, click an empty space in the work area. You can show the handles anytime by selecting **Move** from the slider's context menu.

- To adjust the variable, slide the pointer (or click the arrows on a minimized slider).
  - You can use the **Tab** key to move the focus to a slider or to move from one slider to the next. The color of the slider changes to show you when it has the focus.
  - When a slider has the focus, you can use the arrow keys to change the value of the variable.

### Working with the Slider

Use the options on the context menu to move or delete the slider, and to start or stop its animation. You can also change the slider's settings.

- Display the slider's context menu.

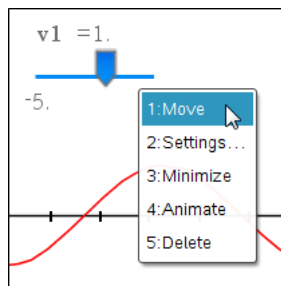

- Click an option to select it.

### Automatic Sliders in Graphs

Sliders can be created for you automatically in the Graphs application and in the analytic window of the Geometry application. You are offered automatic sliders when you define certain functions, equations, or sequences that refer to undefined variables.

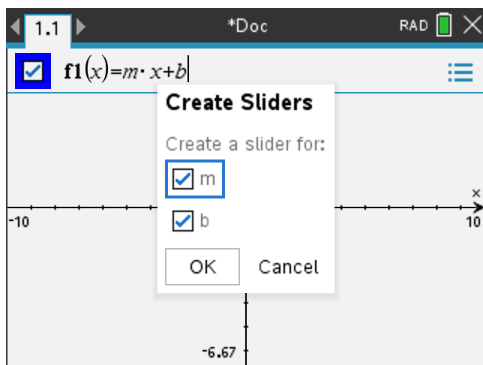

## Inferential Statistics

You can explore hypothesis tests and probability distributions in the Data & Statistics application after entering the data on a Lists & Spreadsheet page.

### Drawing Inferential Statistics Plots

The following example uses the Draw option of the **normCdf()** function to plot a distribution model.

1. On a Lists & Spreadsheet page, select the column-formula cell (second cell from the top) in column A.
2. From the **Statistics** menu, click **Distributions**, and click **Normal Cdf**.

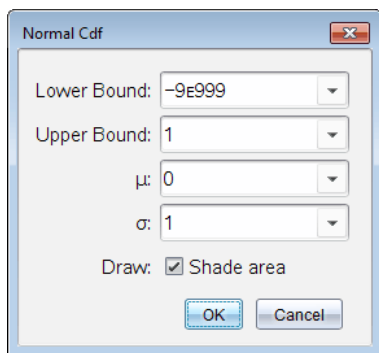

3. Type the plot parameters into the **Normal Cdf** wizard.
4. Select the **Draw** check box to see the distribution plotted and shaded in Data & Statistics.

**Note:** The Draw option is not available for all distributions.

5. Click **OK**.

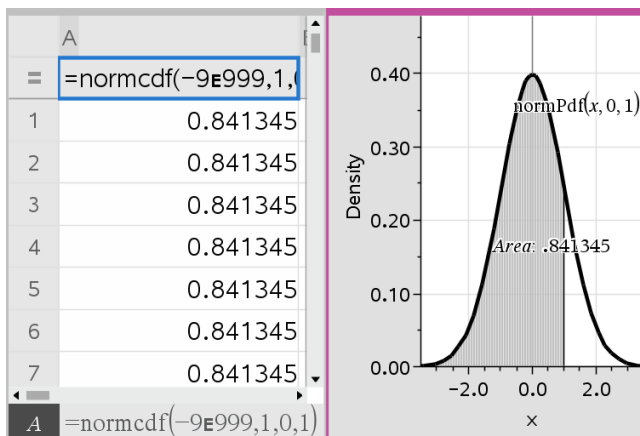

### Exploring Inferential Statistics Plots

After drawing the plot in the previous example, you can explore the effect of changing the upper bound.

- ▶ On the Data & Statistics plot, drag the vertical line that represents the upper bound toward the left or right.

As you drag, the formula is updated and the shaded area is recalculated.

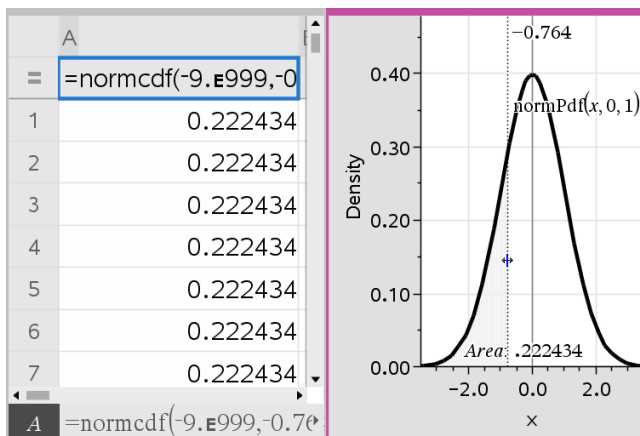

# Notes Application



The Notes application lets you create and share text documents using the TI-Nspire™ handheld and computer software. Use **Notes** to:

- Create study notes to reinforce learning, demonstrate your understanding of classroom concepts, and to review for exams.
- Edit collaboratively by assigning different roles to individuals using your document so that any edits appear in a different text format.
- Create and evaluate math expressions.
- Create correctly formatted chemical formulas and equations.

## Adding a Notes Page

- ▶ To start a new document with a blank Notes page:

From the main **File** menu, click **New Document**, and then click **Add Notes**.

Handheld: Press  on, and select **Notes** .

- ▶ To add a Notes page in the current problem of an existing document:

From the toolbar, click **Insert > Notes**.



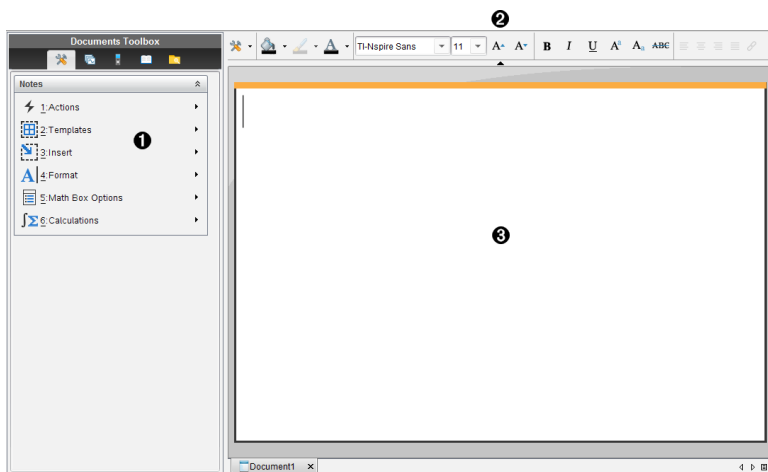

Handheld: Press  and select **Insert > Notes**.



- 1 Notes tools – Available anytime you are in the Notes work area.
- 2 Text formatting toolbar – Lets you change size, color, bold, and other text properties.
- 3 Notes work area – The area where you type and format text.

## Using Templates in Notes

Use the options on the Templates menu to select a format for your Notes page.

	Menu Option	Function
	 2: Templates	
	 1: Q&A	Creates a template to enter question and answer text.
	 2: Proof	Creates a template to enter statement and reason text.
	 3: Default	Lets you type freeform text.
	 4: Hide Answer (Q&A)	Toggles to show or hide the Answer in a Q&A format.

### Selecting a Template

Complete the following steps to select and apply a template:

1. From the Notes menu, click .
2. From the menu, click the template you want to apply.

Handheld: From the Notes work area, press **[menu]**, and then press **▶** to display the menu options.

The Notes page is displayed in the format you selected.

### Using the Q&A Template

Use the Q&A template to create questions and answers. You can show or hide the answer so you can create questions for review and hide the answers. When you use the document as a study aid, you can verify that your answers are correct.

Press **Tab** to move the text cursor between the **Question** and **Answer** areas of the template.

### Using the Proof Template

The proof template provides an outline structure for statements and corresponding reasons.

Press **Tab** to move the text cursor between the **Statements** and **Reasons** areas of the template.

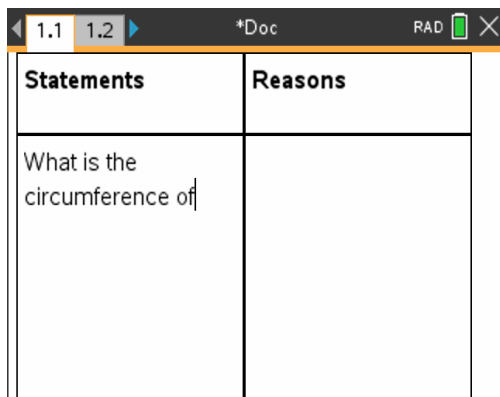

## Formatting Text in Notes

Text formatting lets you apply visual properties, such as bold and italic, to your text.

- **Ordinary text.** Apply most combinations of bold, italic, underline, superscript, subscript, and strikethrough formatting. Select font and font size for any character.
- **Text in a math expression box.** Apply formatting and enter math exponents and math subscripts for variable names. Select font and font size. Font size affects all text in the box.
- **Text in a chemical equation box.** Apply formatting. Select font and font size. Font size affects all text in the box. Superscript and subscript are handled automatically.

### Selecting Text

- ▶ Drag from the starting point to the ending point to select the text.

Handheld: If you are using the Q&A or Proof template, press **tab** to place the cursor in the area containing the text. Use the Touchpad to place the cursor at the start or end of the text to be selected. Hold down **qshift**, and use the Touchpad to select the text.

### Applying a Text Format

1. Select the text that you want to format.
2. On the formatting toolbar, click the formatting icons (such as **B** for bold) to toggle them, or click to select a font and font size.

Handheld: Click **menu**, and then select **Format > Format Text**.

The changes are applied to the text as you make selections.

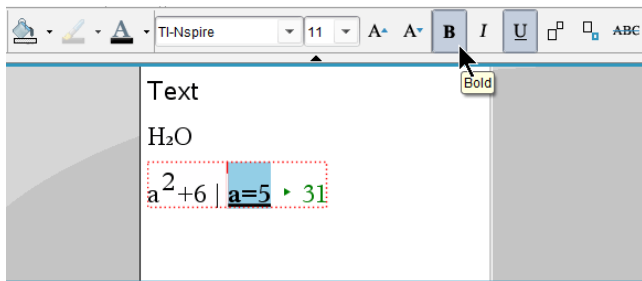

**Note:** The toolbar shows only the icons that are applicable to the type of text selected. For example, superscript ( $A^x$ ) and subscript ( $A_x$ ) are shown only for ordinary text.

## Using Color in Notes

When working in the Notes application on a desktop, use the (fill color) or the (text color) options on the Documents Workspace toolbar to emphasize words, calculations, and formulas.

You can also apply color to text when working in the Notes application on the TI-Nspire™ CX handheld.

### Changing Text Colors

1. Select the text you want to change to another color. You can select a sentence, phrase, word, or a single letter. You can also select a math expression box, a chemical equation box, or individual characters in a calculation, formula, chemical equation, or math template.
2. From the Documents Workspace toolbar, click .

Handheld: Press , and then click **Edit > Text Color**.

The Text Color palette opens.

3. Click a color to apply it to the selected text.

### Applying a Background Color

You can apply a background color to highlight selected characters in ordinary text, text in a math expression, or text in a chemical equation box.

1. Select the text.
2. From the Documents Workspace toolbar, click the arrow next to .

Handheld: Press , and then press **Edit > Fill Color**.



The Fill Color palette opens.

3. Click a color to apply it to the selected text.

## ***Inserting Images***

When working in the Notes application on a desktop, use the Images option on the Insert menu to add an image to a Notes page.

**Note:** The option for inserting an image is not available when working on a handheld. However, you can transfer a file containing an image from your computer to a TI-Nspire™ CX handheld.

1. Click **Insert > Image** from the Documents Toolbar.

The Insert Image window opens.

2. Navigate to the folder where the image is located.
3. Select the image, and then click **Open** to insert the image into the Notes work area. Valid files types are .jpg, .png, or .bmp.
4. To type text around the image, place the cursor in front of the image or after the image, and then type the text.

## ***Resizing an Image***

Complete the following steps to resize an image.

1. Click the image to select it.
2. Move the pointer to the edge of the image.





The pointer changes to a left-right arrow symbol.





3. Drag the image to make it smaller or larger.

For more information, see *Working with Images*.

## ***Inserting Items on a Notes Page***

When working with the Notes application, open the Insert menu to insert a math expression, chemical equation, shape symbol, or a comment.

<b>Menu Name</b>	<b>Menu Option</b>	<b>Function</b>
 <b>3: Insert</b>		
	 <b>1: Math Box</b> -  <b>ctrl</b> M	Lets you insert a math expression.
	 <b>2: Chem box</b>	Lets you insert a chemical formula or equation.

Menu Name	Menu Option	Function
	-  E	
	 3: Shape	Marks the selected text as an angle, triangle, circle, line, segment, ray, or vector.
	 4: Comment	Lets you type text that is italicized and prefaced with <b>Teacher</b> or <b>Reviewer</b> .
	 5: Slider	Lets you insert a slider.

## Inserting Comments in Notes Text

You can insert Teacher or Reviewer comments into a Notes application. Comments are easy to distinguish from the original text.

1. Define the type of comments you are inserting (Teacher or Reviewer):
  - PC: From the **Insert** menu, click **Comment**, and then click **Teacher** or **Reviewer**.
  - Handheld: While in the Notes work area, press  to display the Notes menu. Press **Insert > Comment**, and then select either **Teacher** or **Reviewer**.
2. Type your text.

Text that you type appears in italics.

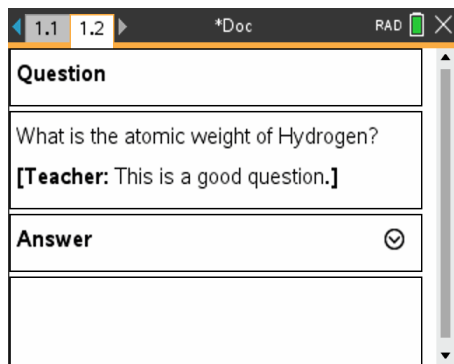

## Inserting Geometric Shape Symbols

You can use geometric shape symbols to designate selected text as geometric objects, such as an angle, circle, or line segment.

To insert a shape symbol, position the cursor where you want it, and then do the following:



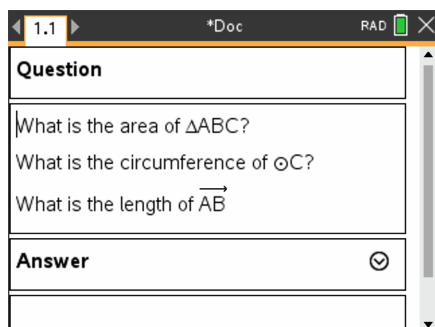

- PC: From the **Insert** menu, click **Shapes**, and then select the shape to apply.
- Handheld: Press **menu** to display the Notes menu. On the **Insert** menu, click **Shapes**, and then select the shape to apply.



### Entering Math Expressions in Notes Text

You can include math expressions in Notes text, using the same tools as in other TI-Nspire™ applications.

Math expression boxes have attributes that allow you to control how the expression is displayed.

Menu Name	Menu Option	Function
 5: Math Box Options		
	 1: Math Box Attributes	When a math box is selected, this option opens a dialog box allowing you to customize the math box. You can hide or show input or output, turn off calculation for the box, insert symbols, change display and angle settings, and allow or disallow the wrapping of expressions and the display of warning indicator after they have been dismissed. You can change the attributes of multiple selected math boxes at the same time.
	 2: Show Warning Info	Displays a warning indicator after the warning has been dismissed.
	 3:	Displays an error after the error has been dismissed.

Menu Name	Menu Option	Function
	Show Error	

### Entering an Expression

1. In the Notes work area, position the cursor where you want the expression.
2. From the **Insert** menu, select **Math Box**.  
—or—  
Press **Ctrl + M** (Mac®: Press **⌘ + M**).

An empty math expression box is displayed.



3. Type the expression in the box. You can use the Catalog, if necessary, to insert a function, command, symbol, or expression template.
4. To exit the math box, click anywhere outside it.

### Evaluating and Approximating Math Expressions

You can evaluate or approximate one or more expressions and display the results. You can also convert selected text and multiple math expression boxes into a single math expression box. Notes automatically updates expressions and any variables used.

Menu Name	Menu Option	Function
	<b>1: Actions</b>	
	1: Evaluate -	Evaluates the expression.
	2: Approximate 	Approximates the expression.
	3: Evaluate and replace	Replaces the selected part of the expression with the result.
	4: Deactivate	Deactivates the current or selected item (box or boxes)
	5: Deactivate All	Deactivates all boxes in the current Notes application.
	6: Activate	Activates the current or selected previously

Menu Name	Menu Option	Function
		deactivated item.
	 7: Activate All	Activates all boxes in the current Notes application.

### Evaluating or Approximating an Expression

To evaluate or approximate an expression, place the cursor anywhere in the math expression box and then do the following:

- Windows®: On the **Actions** menu, click **Evaluate** or **Approximate**. You can also use **Enter** to evaluate or **Ctrl + Enter** to approximate.
- Mac®: Press **⌘ + Enter** to approximate.
- Handheld: Press  to display the Notes menu. On the **Actions** menu, select **Evaluate**.

The result replaces the expression.

### Evaluating Part of an Expression

To evaluate part of an expression, select the text or part of the math expression. Then do the following:

- ▶ On the **Actions** menu, click **Evaluate and Replace**.



Handheld: Press  to open the Notes menu. Select **Actions**, and then select **Evaluate Selection**.

The result replaces the selected part only.

### Breaking Long Calculations

Some calculations may take a long time. Notes indicates that the handheld is performing a long calculation by displaying a busy icon. If a calculation is taking more time than you want to spend, you can end the calculation.

To stop the function or program in progress, do the following:

- Windows®: Hold down the **F12** key and press **Enter** repeatedly.
- Mac®: Hold down the **F5** key and press **Enter** repeatedly.
- Handheld: Hold down the  key and press  repeatedly.

## Showing Warnings and Errors

If a calculation in Notes results in a warning or error, you can view the warning or error again even after you have dismissed the dialog box.

To display a warning or error in Notes after you have dismissed the dialog box, do one of the following:

- Windows®: Right-click and select **Show warning info** or **Show error**.
- Mac®:  $\mathcal{H}$  + click and select **Show warning info** or **Show error**.

**Note:** You can change your settings so that warnings do not appear at all. The showing of warning indicators is controlled by the **Math Box Attributes** dialog box. See *Changing the Attributes of Math Expression Boxes*.

## Converting Selected Items to Math Expression Boxes

To convert items to math expression boxes:

1. Select the text, or combination of text and existing math expression box, that you want to evaluate.
2. From the **Actions** menu, click **Convert to Math Expression Box**.

## Using Math Actions

Math Actions are available on Notes, Scratchpad, and Calculator pages.

When you display the context menu for a selected expression or equation, the menu may include a **Math Actions** submenu that lists the available actions. Each action might prompt you for any needed parameters.

The specific math actions listed depend on:

- The type of expression or relation.
- The operating system in use (Numeric, Exact Arithmetic, or CAS).
- Any restrictions imposed by an active Press-to-Test session.

## Example of Math Actions in Notes

1. Insert a math box, and type the equation  $x^2+3x+1=0$ , but don't press **Enter** yet.

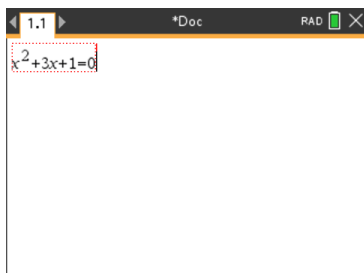

2. Display the context menu of the equation, and select **Math Actions**.  
 Windows®: Right-click the equation.  
 Mac®: Hold  $\mathcal{C}$ , and click the equation.  
 Handheld: Point to the equation, and press **ctrl** **menu**.

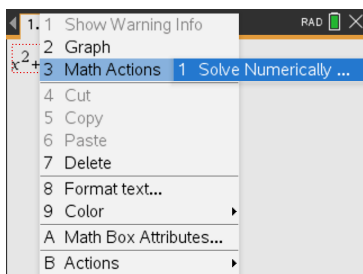

Numeric and Exact Arithmetic OS

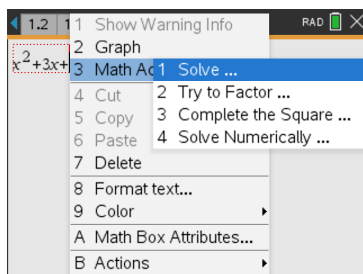

CAS OS

3. Select the action to perform:
  - **Solve Numerically** for Numeric and Exact Arithmetic OS.
  - **Solve** for CAS OS.

You are prompted to enter parameters. For example, Numeric Solve prompts for the variable of interest, initial guess, lower bound, and upper bound.

4. Type a value for each parameter. When options are available, you can click an arrow to make a selection.

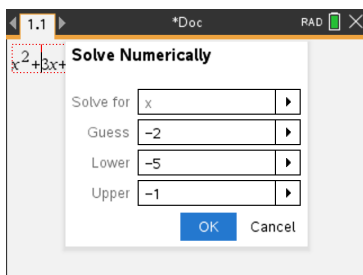

Numeric and Exact Arithmetic OS

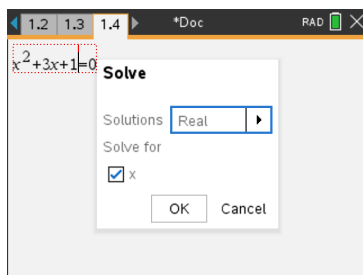

CAS OS

5. Click **OK** to construct the completed expression and place it in the math box.

$$\text{nSolve}(x^2+3x+1=0,x=-2)|-5\leq x\leq-1$$

Numeric and Exact Arithmetic OS

$$\text{solve}(x^2+3x+1=0,x)$$

CAS OS

6. Press **Enter** to complete the action.

$$\text{nSolve}(x^2+3\cdot x+1=0,x=-2)|-5\leq x\leq-1$$

▶ -2.61803

Numeric and Exact Arithmetic OS

$$\text{solve}(x^2+3\cdot x+1=0,x)$$

▶  $x = \frac{-(\sqrt{5}+3)}{2}$  or  $x = \frac{\sqrt{5}-3}{2}$

CAS OS

7. As a further exploration, drag through the math box to select  $x^2+3\cdot x+1$ . Do not include the "=0" portion.

$$\text{nSolve}(x^2+3\cdot x+1=0,x=-2)|-5\leq x\leq-1$$

▶ -2.61803

Numeric and Exact Arithmetic OS

$$\text{solve}(x^2+3\cdot x+1=0,x)$$

▶  $x = \frac{-(\sqrt{5}+3)}{2}$  or  $x = \frac{\sqrt{5}-3}{2}$

CAS OS

8. Display the context menu for the selected text, select **Math Actions > Find Roots of Polynomial**, and press **Enter** to complete the action.

The action and its result are shown in a new math box.

$$\text{polyRoots}(x^2+3\cdot x+1,x)$$

▶  $\{-2.61803, -0.381966\}$

Numeric OS

$$\text{polyRoots}(x^2+3\cdot x+1,x)$$

▶  $\left\{ \frac{-(\sqrt{5}+3)}{2}, \frac{\sqrt{5}-3}{2} \right\}$

Exact Arithmetic and CAS OS

### Tips for Using Math Actions in Notes

- ▶ For a previously evaluated expression, click in the expression and then display its context menu.

When you select an action, it replaces the expression.

- ▶ For a displayed result, click in the result and then display its context menu.

When you select an action, it appears in a new math box.

- ▶ For a portion of an expression or result, select the portion, and then display the context menu.

When you select an action, it appears in a new math box.



## Graphing from Notes and Calculator

You can graph a function or relation directly from its context menu. This feature is available for many functions and relations on Notes, Scratchpad, and Calculator pages.

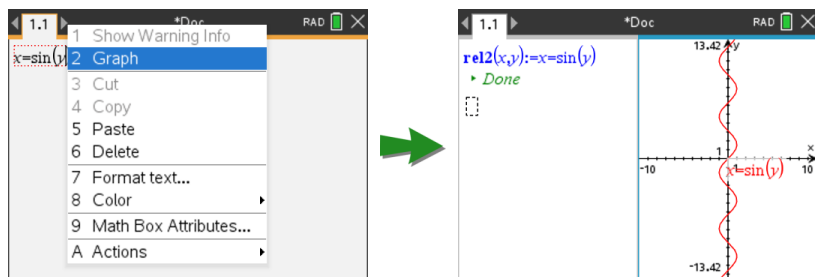

If page layout options allow, the graph appears on the same page as the function or relation. Otherwise, the graph appears on a separate Graphs page.

The type of graph created depends on:

- The type of function or relation.
- Any restrictions imposed by an active Press-to-Test session.

### Example of Graphing from Notes

This example uses a Notes page to explore a quadratic function interactively.

1. Insert a math box on a new Notes page, and enter the following function definition:

**Define  $f1(x) = x^2 - 1 \cdot x - 4$**

A screenshot of a math box containing the text 'Define f1(x)=x^2-1·x-4'. The text is blue and has a dashed red border around it, indicating it is selected or highlighted.

2. Display the context menu of the Define statement.

Windows®: Right-click the statement.

Mac®: Hold  $\mathcal{C}$ , and click the statement.

Handheld: Point to the statement, and press **ctrl** **menu**.

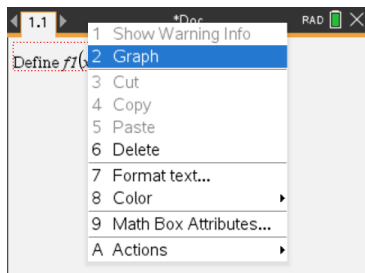

3. Select **Graph** from the context menu.

The graph appears. The graph and the math box are linked so that any adjustment to one affects the other.

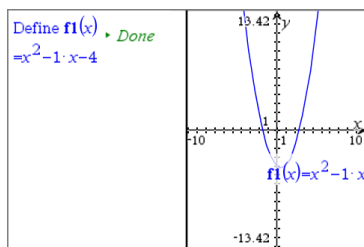

4. Explore the relationship between the defined function and its graph:

- Drag the ends or center of the graph to manipulate it, and observe the changes to the function definition.

—or—

- Edit the defined function in the math box, and observe the changes to the graph.

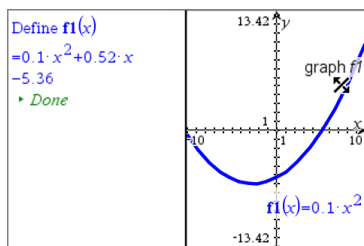

### **Inserting Chemical Equations in Notes**

Chemical equation boxes (chem boxes) make it easy to type chemical formulas and equations, such as  $\text{CH}_4 + 2\text{O}_2 \rightarrow \text{CO}_2 + 2\text{H}_2\text{O}$ .

As you type in a chem box, most of the formatting work is handled automatically:

- Correct capitalization of most element symbols, such as Ag and Cl, is automatic.
- Leading digits are treated as coefficients and are shown at full size. Numbers that follow an element or a closed parenthesis are converted to subscripts.
- The equals "=" symbol is converted to a yields "→" symbol.

#### **Notes:**

- Equations in a chem box cannot be evaluated or balanced.

- Element capitalization may not work in every situation. For example, to enter carbon dioxide, CO<sub>2</sub>, you must manually capitalize the O. Otherwise, typing “co” would result in “Co,” the symbol for cobalt.

### Entering a chemical equation

1. In the Notes work area, position the cursor where you want the equation.
2. From the **Insert** menu, select **Chem Box**.  
—or—  
Press **Ctrl + E** (Mac®: Press **⌘ + E**).

An empty chemical equation box is displayed.



3. Type the equation in the box. For example, to represent sulphuric acid, type **h2sO4**, capitalizing the O manually.

The chem box automatically formats the text as you type:



4. If you need superscripts for ionic equations, type a caret symbol (^) and then the text.



5. Use parentheses to indicate whether a compound is solid (s), liquid (l), gas (g), or aqueous (aq).

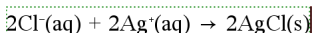

6. To exit the chem box, click anywhere outside it.

### Deactivating Math Expression Boxes

Calculations are by default activated, which means that results automatically update when you evaluate or approximate an expression. If you don't want results to automatically update, you can deactivate a math expression box, group of boxes, or the entire application.

#### Deactivating a Box or a Group of Boxes

To deactivate a box or a group of boxes:

1. Select the box or boxes that you want to deactivate.
2. Deactivate the selected box or boxes:
  - Windows®: Click **Actions > Deactivate** (or right-click and then click **Actions > Deactivate**).
  - Mac®: Click **Actions > Deactivate** (or **⌘ + click** and then click **Actions > Deactivate**).

- Handheld: Press **menu** to open the Notes menu. From the **Actions** menu, select **Deactivate**.

**Note:** You can manually update a deactivated box or boxes by selecting the box or boxes and using the process described in *Evaluating and Approximating Math Expressions*.

### Deactivating All Boxes in the Notes Application

To deactivate all boxes in the Notes application:

- ▶ With a document open, place your cursor in the Notes application that you want to deactivate and select **Deactivate All**.
  - Windows®: Click **Actions > Deactivate All** or right-click and click **Actions > Deactivate All**.
  - Mac®: Click **Actions > Deactivate** or **⌘**+ click and click **Actions > Deactivate**.
  - Handheld: Press **menu** to display the Notes menu. On the **Actions** menu, click **Deactivate**.

**Note:** When you use this option in Q&A and Proof templates, Deactivate All deactivates only the math boxes in the current work area.

### Changing the Attributes of Math Expression Boxes

You can change attributes in one or more math expression boxes at the same time. Controlling the attributes in math expression boxes allows you to do the following:

- Show or hide the input or output, or prevent calculation in the box.
- Select a symbol separator using Insert Symbol.
- Choose the number of digits to display in the output of a math expression.
- Select angle settings so you can use a combination of radian, degree, and gradian angle measures in the same Notes application.
- Select whether to allow math expressions to wrap.
- Select whether to show or hide warning indicators.

To change the attributes of one or more boxes, do the following:

1. Select the box or boxes that you want to change.
2. On the **Math Box Options** menu, click **Math Box Attributes**.
3. Use the menus or selection boxes to make your selections.
4. Click **OK** to save or **Cancel** to abandon the change.

**Note:** Math expression boxes recalculate automatically after you have made attribute changes and saved the changes.

## Undoing Changes to Math Expression Boxes







- To undo changes you have made to a math expression box, press **Ctrl+Z**.





## Using Calculations in Notes

In the Notes application, the options on the Calculations menu enable you to perform calculations. The calculations are described in the following table.

### Important Information to Know

- Notes does not support editing programs. Use Program Editor instead.
- Notes does not support executing Lock or Unlock commands. Use Calculator instead.
- Notes does not display intermediate results obtained using the "Disp" command. Use Calculator instead.
- Notes does not support user-defined dialog boxes obtained using the "Request," "RequestStr," or "Text" commands. Use Calculator instead.
- Notes does not support the execution of multiple statistics commands that produce stat. variables.

Menu Name	Menu Option	Function
 6: Calculations		
	 1: Define Variables	Define a variable in a Note using the Calculator application.
	 2: Number	Use tools from the Calculator Number menu, including Convert to Decimal, Approximate to Fraction, Factor, Least Common Multiple, Greatest Common Divisor, Remainder, Fraction Tools, Number Tools, and Complex Number Tools.
	 3: Algebra	Use tools from the Calculator Algebra menu, including Numerical Solve, Solve System of Linear Equations, Polynomial Tools.
	 4: Calculus	Use tools from the Calculus menu including Numerical Derivative at a Point, Numerical Definite Integral, Sum, Product, Numerical Function Minimum, and Numerical Function Maximum.
	 3 (CAS): Algebra	Use tools from the Calculator Algebra menu, including Solve, Factor, Expand, Zeros, Numerical Solve, Solve System of Equations, Polynomial Tools, Fraction Tools, Convert Expressions, Trigonometry, Complex, and Extract.

Menu Name	Menu Option	Function
	 4 (CAS): Calculus	Use tools from the Calculus menu including Derivative, Derivative at a Point, Integral, Limit, Sum, Product, Function Minimum, Function Maximum, Tangent Line, Normal Line, Arc Length, Series, Differential Equation Solver, Implicit Differentiation, and Numerical Calculations
	 5: Probability	Use tools from the Calculator Probability menu, including Factorial, Permutations, Combinations, Random, and Distributions.
	 6: Statistics	Use tools from the Calculator Statistics menu, including Stat Calculations, Stat Results, List Math, List Operations, and others.
	 7: Matrix & Vector	Use tools from the Calculator Matrix & Vector menu, including Create, Transpose, Determinant, Row-Echelon Form, Reduced Row-Echelon Form, Simultaneous, and others.
	 8: Finance	Use tools from the Calculator Finance menu, including Finance Solver, TVM Functions, Amortization, Cash Flows, Interest Conversions, and Days between Dates.
	<b>Note:</b> For more information, see the Calculator chapter.	

## Exploring Notes with Examples

This section shows you how the Notes application works with other applications to automatically update results.

### Example #1: Using Notes to Explore Roots of a Quadratic Function

1. Open a new document and select the Notes application.
2. Define a function in a math box, evaluate, and hide the output using the Math Box attributes.

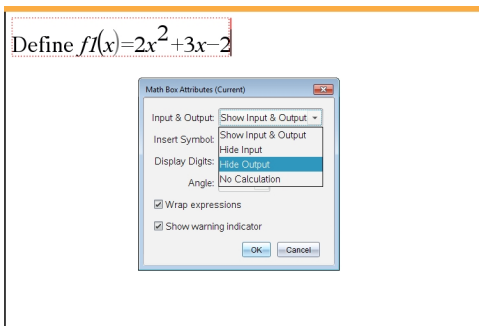

3. Type some more text; for example: **Real Roots of f1 (x) are:**
4. In a new math box, type: **polyRoots (f1 (x) , x)**.
5. Press **Enter** and hide the input of this math box by using the Math Box attributes dialog box.
6. Use the Page Layout toolbar icon to select the split layout.

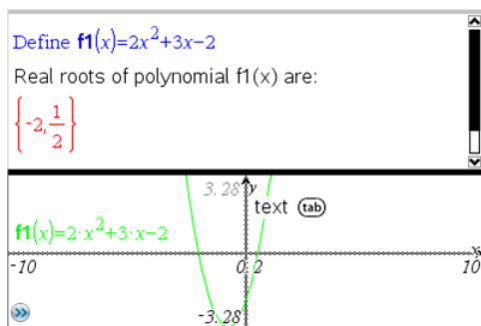

7. Add the Graph application and plot  $f1(x)$ .

See how the roots of  $f1$  change when the function is modified in Graph.

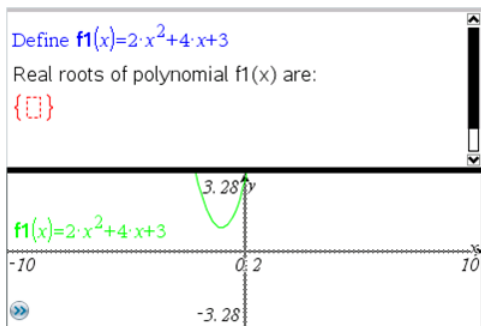

## Example #2: Using Notes to Explore Data Sampling

This example shows how to create a sampling distribution of sample means drawn from a given population. We will be able to watch the sampling distribution take shape for a given sample size and describe its characteristics. You can change the population and the sample size.

1. Set up the population and the sample size.
  - a) Type **Create sample data**:
  - b) Insert a math expression box and define the population. For example, type **population:=seq(n,n,1,50)**.
  - c) Press **Enter** and hide the output using the Math Expression Box Attributes dialog box.
  - d) Insert a math expression box and define the sample size. For example, type **size:=5**.
  - e) Press **Enter** and hide the output using the Math Expression Box Attributes dialog box.
2. Set up the initialization.
  - a) Type **Start taking samples**:
  - b) Insert a math expression box and set the initial values for the number of samples (*num*) and the list of sample means (*sampmeans*). Type:
   
**num:=0:sampmeans:={ }**
  - c) Press **Enter** and hide the output using the Math Expression Box Attributes dialog box.



- d) Deactivate the math expression box using **Actions > Deactivate**. The deactivation will prevent the content of that math box from being overwritten when the values for *num* and *sampmeans* change. The deactivated math box will be shown with the light color background.
3. Set up Data & Statistics for the sampling.
    - a) Change the page layout and insert Data & Statistics.
    - b) Click on the horizontal axis and add *sampmeans* list.
    - c) Change the window setting: *XMins*=1 and *XMax* = 50.
    - d) You can also set up the plot of the mean of sample means using **Analyze > Plot Value**.

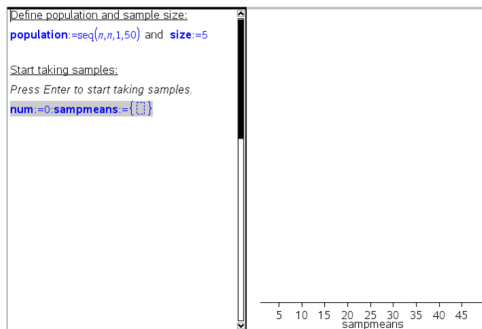

4. Enter the instructions to add data.
  - a) Type **Create new samples**:
  - b) Insert a math expression to define the sample (*sample*) and update the number of samples and the list of sample means. Type:
 

```
num:=num+1:sample:=randsamp(population,size):
sampmeans:=augment(sampmeans,{mean(sample)})
```
  - c) Press **Enter**, hide the output, and turn off the expression wrapping using the Math Expression Box Attributes dialog box.
  - d) Deactivate the math expression box using **Actions > Deactivate** to prevent the contents of the math box from changing when *num* and *sampmeans* values are reinitialized.
  - e) Create math expression boxes that display the current number of experiments (*num*), sample (*sample*), and the list of sample means (*sampmeans*).

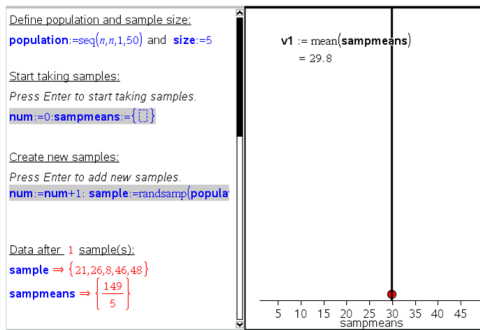

5. Now you are ready to explore. Add more samples by simply pressing **Enter** when you are in the math expression box in the "Create new samples" section.

**Note:** You can also automate the sampling process by using a **For ... EndFor** loop.

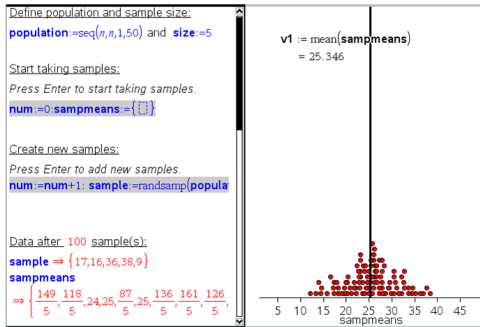

You can also change the sample size and restart the sampling.

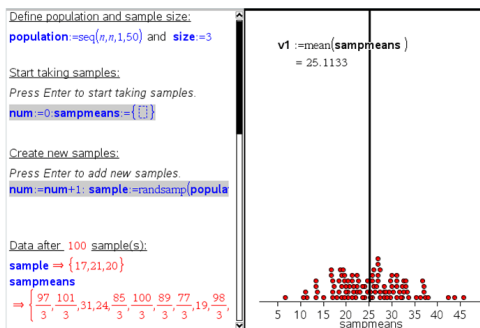

# Data Collection

The Vernier DataQuest™ application is built into the TI-Nspire™ software and the operating system (OS) for handhelds. The application lets you:

- Capture, view, and analyze real-world data using a TI-Nspire™ CX II handheld, a Windows® computer, or a Mac® computer.
- Collect data from up to five connected sensors (three analog and two digital) using the TI-Nspire™ Lab Cradle.

**Important:** The TI-Nspire™ CM-C Handheld is not compatible with the Lab Cradle and only supports the use of a single sensor at a time.

- Collect data either in the classroom or at remote locations using collection modes such as time-based or event-based.
- Collect several data runs for comparison.
- Create a graphical hypothesis using the Draw Prediction feature.
- Play back the data set to compare the outcome to the hypothesis.
- Analyze data using functions such as interpolation, tangential rate, or modeling.
- Send collected data to other TI-Nspire™ applications.
- Access sensor data from all connected sensor probes through your TI-Basic program.



## Adding a Vernier DataQuest™ Page

**Note:** The application is launched automatically when you connect a sensor.

Starting a new document or problem for each new experiment ensures that the Vernier DataQuest™ application is set to its default values.

- ▶ To start a new document containing a data collection page:

From the main **File** menu, click **New Document**, and then click **Add Vernier DataQuest™**.





Handheld: Press  **on**, and select **Vernier DataQuest™** .

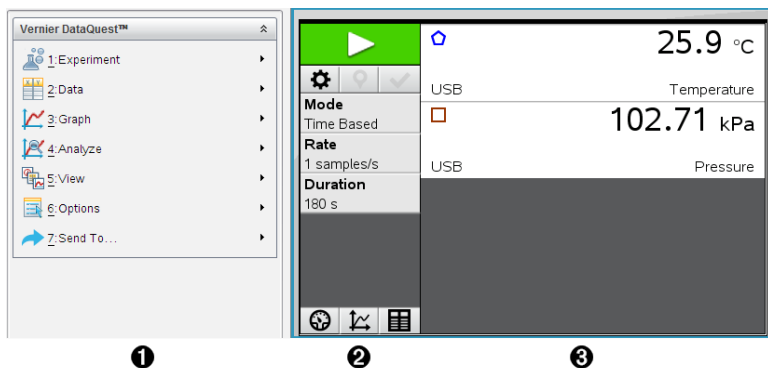

- ▶ To insert a new problem with a data collection page into an existing document:

From the toolbar, click **Insert > Problem>Vernier DataQuest™**.

Handheld: Press  **doc** and select **Insert > Problem > Vernier DataQuest™**.



- 1 Vernier DataQuest™ Menu.** Contains menu items for setup, collection, and analysis of sensor data.
- 2 Details view.** Contains buttons for starting data collection , changing collection settings , marking collected data , storing data sets , and tabs for managing multiple data runs.

View selection buttons let you choose from Meter view , Graph view , or Table view .
- 3 Data work area.** The information displayed here depends on the view.

**Meter.** Displays a list of sensors that are currently connected or set up in advance.

**Graph.** Displays collected data in a graphical representation, or displays the prediction before a data collection run.

**Table.** Displays collected data in columns and rows.

## What You Must Know

### Basic Steps in Performing an Experiment

These basic steps are the same no matter which type of experiment you perform.

1. Start the Vernier DataQuest™ Application.
2. Connect sensors.
3. Modify sensor settings.
4. Select the collection mode and collection parameters.
5. Collect data.
6. Stop collecting data.
7. Store the data set.
8. Save the document to save all data sets in the experiment.
9. Analyze the data.

## Sending Collected Data to Other TI-Nspire™ Applications

You can send collected data to the Graphs, Lists & Spreadsheet, and Data & Statistics applications.

- ▶ From the **Send To** menu, click the name of the application.

A new page showing the data is added to the current problem.

## About Collection Devices

You can select from a variety of sensors and interfaces to collect data while running the Vernier DataQuest™ application with TI-Nspire™ software.

### Multi-Channel Sensor Interfaces

Multi-channel sensor interfaces let you connect more than one sensor at a time.

Sensor Interface	Description
	<p>This sensor can be used with a handheld, a computer, or as a stand-alone sensor.</p> <p>The sensor interface allows you to connect and use one to five sensors at the same time. It can be used in the lab or at a remote collection location.</p> <p>The Lab Cradle supports two digital sensors and three analog sensors.</p> <p>The Lab Cradle also supports high-sample data collection sensors, such as a hand-grip heart rate or a blood pressure monitor.</p> <p>After using the Lab Cradle as a remote sensor, you can download data to either a handheld or computer.</p>

Texas Instruments  
TI-Nspire™ Lab  
Cradle

### Single-Channel Sensor Interfaces

Single-channel sensor interfaces can only connect to one sensor at a time. These sensors have either a mini-USB connector for a handheld or a standard USB connector for a computer. For a complete list of compatible sensors, see *Compatible Sensors*.

Sensor Interface	Description
	<p>This sensor interface is used with handhelds. It has a mini-USB connector so it can be plugged directly into the handheld.</p> <p>Connect sensors to Vernier EasyLink® to:</p> <ul style="list-style-type: none"><li>• Measure barometric pressure.</li><li>• Measure the salinity of a solution.</li></ul>

Sensor Interface	Description
<b>Vernier EasyLink®</b>	<ul style="list-style-type: none"> <li>Investigate the relationship between pressure and volume (Boyles' Law).</li> </ul>
 <p>Vernier Go!Link®</p>	<p>This sensor interface is used with computers. It has a standard connector so it can be plugged into a Windows® or Mac® computer.</p> <p>Connect sensors to Vernier GoLink® to:</p> <ul style="list-style-type: none"> <li>Measure the acidity or alkalinity of a solution.</li> <li>Monitor greenhouse gases.</li> <li>Measure sound level in decibels.</li> </ul>

## Types of Sensors

- Analog sensors.** Temperature, light, pH, and voltage sensors are analog sensors and require a sensor interface.
- Digital sensors.** Photogates, radiation monitors, and drop counters are digital sensors. These sensors can only be used with the TI-Nspire™ Lab Cradle.
- Direct-connect USB sensors.** These sensors connect directly to a handheld or computer and do not require a sensor interface.

## Sensors for Handhelds



The following lists some sensors you can use with a handheld.

Sensor	Description
 <p>Texas Instruments CBR 2™</p>	<p>This analog sensor connects directly to TI-Nspire™ CX II handhelds through the mini-USB port. It is used to explore and graph motion.</p> <p>This sensor automatically launches the Vernier DataQuest™ application when you connect it to a handheld. Data collection begins when you select the Motion Match function.</p> <p>This sensor collects up to 200 samples per second.</p> <p>Use this sensor to:</p> <ul style="list-style-type: none"> <li>Measure position and speed of a person or object.</li> <li>Measure the acceleration of an object.</li> </ul>

Sensor	Description
 <p><b>Vernier EasyTemp® temperature sensor</b></p>	<p>This analog sensor connects directly to TI-Nspire™ CX II handhelds through the mini-USB port and is used to collect temperature ranges. You can design experiments to:</p> <ul style="list-style-type: none"> <li>• Collect weather data.</li> <li>• Record temperature changes due to chemical reactions.</li> <li>• Perform heat fusion studies.</li> </ul>

### Sensors for Computers

The following table lists some sensors you can use with a computer.

Sensor	Description
 <p><b>Vernier Go!Temp® temperature sensor</b></p>	<p>This analog sensor connects to the computer's USB port and is used to collect temperature ranges. You can use this sensor to:</p> <ul style="list-style-type: none"> <li>• Collect weather data.</li> <li>• Record temperature changes due to chemical reactions.</li> <li>• Perform heat fusion studies.</li> </ul>
 <p><b>Vernier Go!Motion® motion detector</b></p>	<p>This analog sensor connects to the computer's USB port and is used to measure acceleration, speed, and velocity. Use this sensor to:</p> <ul style="list-style-type: none"> <li>• Measure position and speed of a person or object.</li> <li>• Measure the acceleration of an object.</li> </ul>

### Compatible Sensors

The following sensors can be used with the Vernier DataQuest™ application.

- 25-g Accelerometer
- 30-Volt Voltage Probe
- 3-Axis Accelerometer
- Low-g Accelerometer

- CBR 2™ - Connects directly to handheld USB port
- Go!Motion® - Connects directly to computer USB port
- Extra Long Temperature Probe
- Stainless Steel Temperature Probe
- Surface Temperature Sensor
- Ammonium Ion-Selective Electrode
- Anemometer
- Barometer
- Blood Pressure Sensor
- CO2 Gas Sensor
- Calcium Ion-Selective Electrode
- Charge Sensor
- Chloride Ion-Selective Electrode
- Colorimeter
- Conductivity Probe
- High Current Sensor
- Current Probe
- Differential Voltage Probe
- Digital Radiation Monitor
- Dissolved Oxygen Sensor
- Dual-Range Force Sensor
- EasyTemp® - Connects directly to handheld USB port
- EKG Sensor
- Electrode Amplifier
- Flow Rate Sensor
- Force Plate
- Gas Pressure Sensor
- Go!Temp® - Connects directly to computer USB port
- Hand Dynamometer
- Hand-Grip Heart Rate Monitor
- Instrumentation Amplifier
- Light Sensor
- Magnetic Field Sensor
- Melt Station
- Microphone



- Nitrate Ion-Selective Electrode
- O<sub>2</sub> Gas Sensor
- ORP Sensor
- pH Sensor
- Relative Humidity Sensor
- Respiration Monitor Belt (Requires Gas Pressure Sensor)
- Rotary Motion Sensor
- Salinity Sensor
- Soil Moisture Sensor
- Sound Level Meter
- Spirometer
- Thermocouple
- TI-Light - Sold only with the CBL 2™
- TI-Temp - Sold only with the CBL 2™
- TI-Voltage - Sold only with the CBL 2™
- Tris-Compatible Flat pH Sensor
- Turbidity Sensor
- UVA Sensor
- UVB Sensor
- Vernier Constant Current System
- Vernier Drop Counter
- Vernier Infrared Thermometer
- Vernier Motion Detector
- Vernier Photogate
- Voltage Probe
- Wide-Range Temperature Probe

### **Connecting Sensors**

Direct-connect USB sensors, such as the Vernier Go!Temp® temperature sensor (for computers) or the Vernier EasyLink® temperature sensor (for handhelds), connect directly to the computer or handheld and do not need a sensor interface.

Other sensors require a sensor interface such as the TI-Nspire™ Lab Cradle.

#### **Connecting Directly**

- ▶ Attach the cable on the sensor directly to the computer's USB port or to an appropriate port on the handheld.

## Connecting through a Sensor Interface

1. Attach the sensor to the sensor interface using either the mini-USB, USB, or BT connector and the appropriate cable.
2. Attach the interface to a computer or handheld using the appropriate connector and cable.

**Note:** To attach a handheld to a TI-Nspire™ Lab Cradle, slide the handheld into the connector at the bottom of the Lab Cradle.

## Setting Up an Offline Sensor

You can predefine meter settings for a sensor that is not currently attached to a computer or handheld.

You cannot use the sensor offline, but you can prepare the experiment for it and then attach it when ready to collect the data. This option makes it faster to share a sensor during a lesson or lab in which there are not enough sensors for everyone.

1. From the **Experiment** menu, select **Advanced Set Up > Configure Sensor > Add Offline Sensor**.

The Select Sensor dialog box opens.

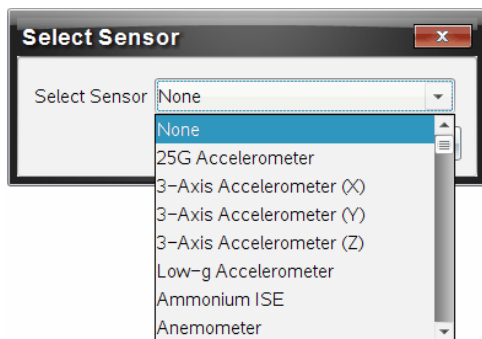

2. Select a sensor from the list.
3. Click the **Meter View** tab .
4. Click the sensor you have added, and [modify its settings](#).

The settings will be applied when you attach the sensor.

## Removing an offline sensor

1. From the **Experiment** menu, select **Advanced Setup > Configure Sensor**.
2. Select the name of the offline sensor to remove.
3. Click **Remove**.

## Modifying Sensor Settings

You can modify how the sensor values are displayed and stored. For example, when using a temperature sensor, you can change the unit of measure from Centigrade to Fahrenheit.

### Changing Sensor Measurement Units

Measurement units depend on the selected sensor. For example, units for the Vernier Go!Temp<sup>®</sup> Temperature sensor are Fahrenheit, Celsius, and Kelvin. Units for the Vernier Hand Dynamometer (a specialized force sensor) are Newton, Pound, and Kilogram.

You can change the units before or after you collect data. The collected data reflects the new measurement unit.

1. Click Meter view  to display the connected and offline sensors.
2. Click the sensor whose units you want to change.
3. In the Meter Settings dialog box, select the unit type from the **Measurement Units** menu.

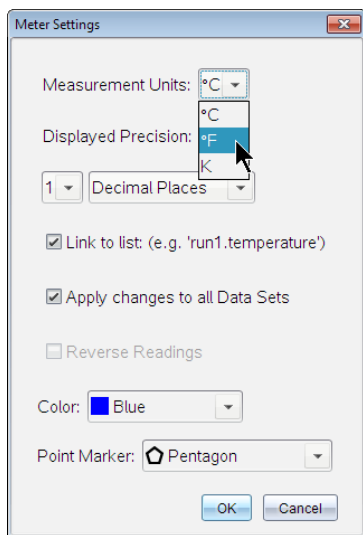

## Calibrating a Sensor

When the software or handheld detects a sensor, the calibration for that sensor automatically loads. You can calibrate some sensors manually. Other sensors, such as the Colorimeter and the Dissolved Oxygen Sensor, must be calibrated to provide useful data.

There are three options for calibrating a sensor:

- Manual Entry
- Two Point
- Single Point

Refer to the sensor's documentation for specific calibration values and procedures.

## Setting a Sensor to Zero

You can set the standing value of some sensors to zero. You cannot set sensors in which relative measurements such as force, motion, and pressure are common to zero. Sensors designed to measure specific environmental conditions, such as Temperature, pH, and CO<sub>2</sub> also cannot be set to zero.

1. Click Meter view  to display the connected and offline sensors.
2. Click the sensor that you want to set to zero.
3. In the Meter Settings dialog box, click **Zero**.

## Reversing a Sensor's Readings

By default, pulling with a force sensor produces a positive force and pushing produces a negative force. Reversing the sensor allows you to display pushing as a positive force.

1. Click Meter view  to display the connected and offline sensors.
2. Click the sensor that you want to reverse.
3. In the Meter Settings dialog box, click **Reverse Readings**.

The sensor display is now reversed. In Meter View, the reverse indicator  appears after the sensor name.

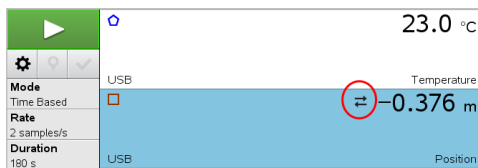

## Collecting Data

### Collecting Time-Based Data

The Time Based collection mode captures sensor data automatically at regular time intervals.

1. Connect the sensor or sensors.

Sensor names are added to the sensor list automatically.

2. From the **Experiment** menu, select **New Experiment**.

This removes all data and restores all meter settings to their defaults.

3. From the **Experiment** menu, select **Collection Mode > Time Based**.

- a) Select **Rate** or **Interval** from the drop-down list, and then type the **Rate** (samples/second) or **Interval** (seconds/sample).

- b) Type the **Duration** of the collection.

The Number of points is calculated and displayed, based on rate and duration.  
Note that collecting too many data points can slow system performance.

- c) Select **Strip Chart** if you want to collect samples continuously, retaining only the last  $n$  samples. (where “ $n$ ” is the number shown in the Number of points field.)

4. [Modify sensor settings](#) as necessary.

5. Click **Start Collection** .

6. After the data has been collected, click **Stop Collection** .

The data set run is complete.

### Collecting Selected Events

Use the Selected Events collection mode to capture samples manually. In this mode, each sample is automatically assigned an event number.

1. Connect the sensor or sensors.

Sensor names are added to the sensor list automatically.

2. From the **Experiment** menu, select **New Experiment**.

This removes all data and restores all meter settings to their defaults.

3. From the **Experiment** menu, select **Collection Mode > Selected Events**.

The Selected Events Setup dialog box opens.

- **Name.** This text is visible in the Meter View. Its first letter is displayed as the independent variable in the Graph view.
- **Units.** This text is displayed in Graph view alongside the Name.
- **Average over 10 s.** This option averages ten seconds of data for each point.

4. [Modify sensor settings](#) as necessary.

5. Click **Start Collection** .

The Keep Current Reading icon  becomes active. The current sensor value appears in the center of the graph.

6. Click **Keep Current Reading**  to capture each sample.

The data point is plotted, and the current sensor value appears in the center of the graph.

**Note:** If you selected the Averaging option, a countdown timer appears. When the counter reaches zero, the system plots the average.

7. Continue capturing until you collect all of the desired data points.

8. Click **Stop Collection** .

The data set run is complete.

### Collecting Events with Entry

Use the Events with Entry collection mode to capture samples manually. In this mode, you define the independent value for each point you collect.

1. Connect the sensor or sensors.

Sensor names are added to the sensor list automatically.

2. From the **Experiment** menu, select **New Experiment**.

This removes all data and restores all meter settings to their defaults.

3. From the **Experiment** menu, select **Collection Mode > Events with Entry**.

The Events with Entry Setup dialog box opens.

- **Name.** This text is visible in the Meter View. Its first letter is displayed as the independent variable in the Graph view.
- **Units.** This text is displayed in Graph view alongside the Name.

- **Average over 10 s.** This option averages ten seconds of data for each point.

4. [Modify sensor settings](#) as necessary.

5. Click **Start Collection** .

The Keep Current Reading icon  becomes active. The current sensor value appears in the center of the graph.

6. Click **Keep Current Reading**  to capture a sample.

The Events with Entry dialog box opens.

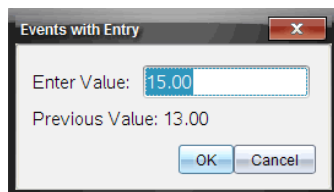

7. Type a value for the independent variable.

8. Click **OK**.

The data point is plotted, and the current sensor value appears in the center of the graph.

**Note:** If you selected the Averaging option, a countdown timer appears. When the counter reaches zero, the system plots the average.

9. Repeat steps 6 through 8 until you collect all of the desired data points.

10. Click **Stop Collection** .

The data set run is complete.

### Collecting Photogate Timing Data



The Photogate Timing collection mode is available only when using the Vernier Photogate sensor. This sensor can time objects that pass through the gates or objects that pass outside of the gates.

1. Connect the Photogate sensor or sensors.

Sensor names are added to the sensor list automatically.

2. From the **Experiment** menu, select **New Experiment**.

This removes all data and restores all meter settings to their defaults.

3. From the **Experiment** menu, select **Collection Mode > Photogate Timing**.
4. Set the collection options.
5. [Modify sensor settings](#) as necessary.
6. Click **Start Collection** .
7. After the data has been collected, click **Stop Collection** .

The data set run is complete.

### Collecting Drop Counter Data



The Drop Counting collection mode is available only when using the Vernier Drop Counter optical sensor. This sensor can count the number of drops or record the amount of liquid added during an experiment.

1. Connect the Drop Counter sensor or sensors.

Sensor names are added to the sensor list automatically.

2. From the **Experiment** menu, select **New Experiment**.

This removes all data and restores all meter settings to their defaults.

3. From the **Experiment** menu, select **Collection Mode > Drop Counting**.
4. Set the collection options.
5. [Modify sensor settings](#) as necessary.
6. Click **Start Collection** .
7. After the data has been collected, click **Stop Collection** .

The data set run is complete.

### Using Data Markers to Annotate Data

Data markers give you a way to emphasize specific data points, such as when you change a condition. For example, you might mark a point at which a chemical is added to a solution or when heat is applied or removed. You can add a marker with or without a comment, and you can hide a comment.



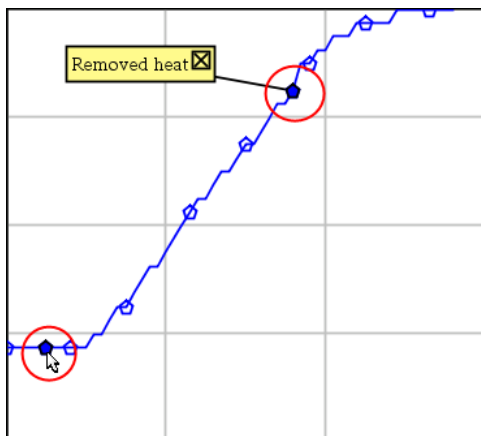

Two data markers, one with a comment displayed

4	1.0	28.4
5	2.0	28.4
6	2.5	28.4
7	3.0	28.4
8	3.5	28.4
9	4.0	28.4
10	4.5	28.4
11	5.0	28.4
12	5.5	28.5

Marker shown as red triangle in Table view

### Adding a Marker During Data Collection

- Click **Add Data Marker**  to place a marker at the current data point.

### Adding a Marker After Collecting Data

1. In Graph or Table view, click the point at which you want a marker.
2. Click **Add Data Marker** .

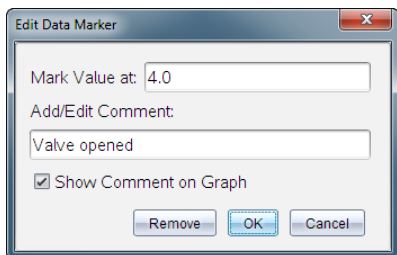

3. Complete the items in the dialog box.

### Adding a Comment to an Existing Marker

1. In the Detail view, click to expand the list of markers for the data set.

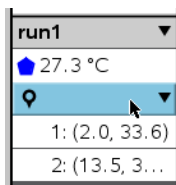

2. Click the entry for the marker that you want to change, and complete the items in the dialog box.

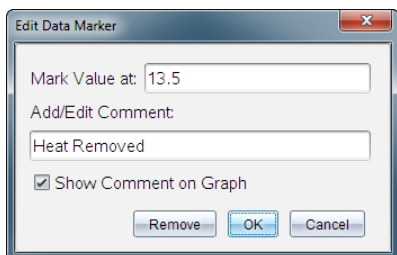

### Repositioning a Data Marker

1. Click to expand the list of markers in the Detail view.

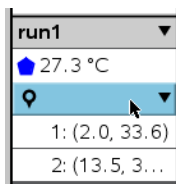

2. Click the entry for the marker that you want to change.
3. In the dialog box, type a new value for **Mark Value at**.

### Moving a Data Marker's Comment in the Graph View

- ▶ Drag the comment to move it. The connecting line remains attached to the data point.

### Hiding/Showing a Data Marker's Comment

- ▶ Hide a comment by clicking the **X** at the end of the comment.
- ▶ To restore a hidden comment:

- a) Click to expand the list of markers in the Detail view.

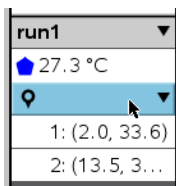

- b) Click the entry for the marker that you want to change, and check **Show Comment on Graph**.

### Removing a Data Marker

1. Click to expand the list of markers in the Detail view.

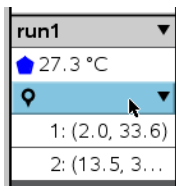

2. In the dialog box, click **Remove**.

## Collecting Data Using a Remote Collection Unit

To collect information from a sensor while it is disconnected, you can set it up as a remote sensor. Only the TI-Nspire™ Lab Cradle, TI CBR 2™, and Vernier Go!Motion® support remote data collection.

You can set up a remote collection unit to start collecting:

- When you press a manual trigger on the unit, as on the TI-Nspire™ Lab Cradle
- When a delay countdown expires on a unit that supports a delayed start

## Setting Up for Remote Collection

1. Save and close any open documents, and start with a new document.
2. Connect the remote collection unit to the computer or handheld.
3. [Modify the sensor settings.](#)
4. Click the Collection Setup button .
5. On the Collection Setup screen, check **Enable Remote Collection**.
6. Select the remote collection unit from the **Devices** list.
7. Specify the method for starting the collection:
  - To start automatically after a specified delay (on supported units), type the delay value.
  - To start when you press the manual trigger (on supported units), type a delay value of **0**. When you use a delay, the manual trigger button on the TI-Nspire™ Lab Cradle has no effect on the start of the collection.

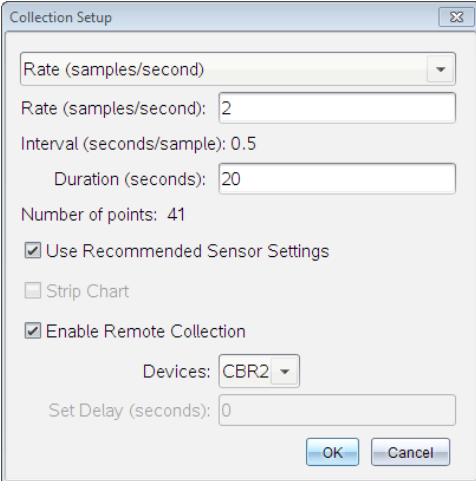

Collection Setup

Rate (samples/second) ▼

Rate (samples/second): 2

Interval (seconds/sample): 0.5

Duration (seconds): 20

Number of points: 41

Use Recommended Sensor Settings

Strip Chart

Enable Remote Collection

Devices: CBR2 ▼

Set Delay (seconds): 0

OK Cancel

8. Click **OK**.

A message confirms that the unit is ready.

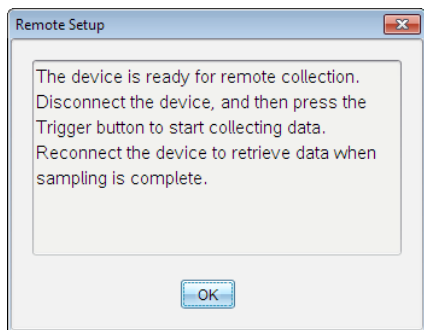

9. Disconnect the unit.

Depending on the device, LED lights may indicate its status.

**Red.** The system is not ready.

**Amber.** The system is ready but not collecting data.

**Green.** The system is collecting data.

10. If you are starting collection manually, press the trigger when ready. If you are starting based on a delay, the collection will start automatically when the countdown is complete.

### Retrieving the Remote Data

After collecting data remotely, you transfer it to the computer or handheld for analysis.

1. Open the Vernier DataQuest™ application.
2. Attach the TI-Nspire™ Lab Cradle to the handheld or computer.

The Remote Data Detected dialog box opens.

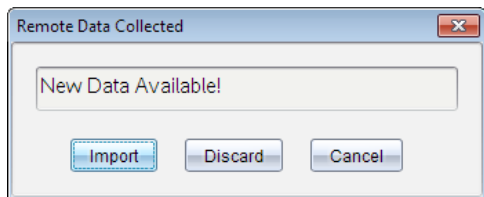

3. Click **Import**.

The data transfers to the Vernier DataQuest™ application.

### Setting Up a Sensor for Automatic Triggering

To start data collection automatically based on a specific sensor reading, the TI-Nspire™ Lab Cradle and sensor must be connected.

1. Connect the sensor.

2. Click **Experiment > Advanced Set up > Triggering > Set Up**.

The Configure Trigger dialog box opens.

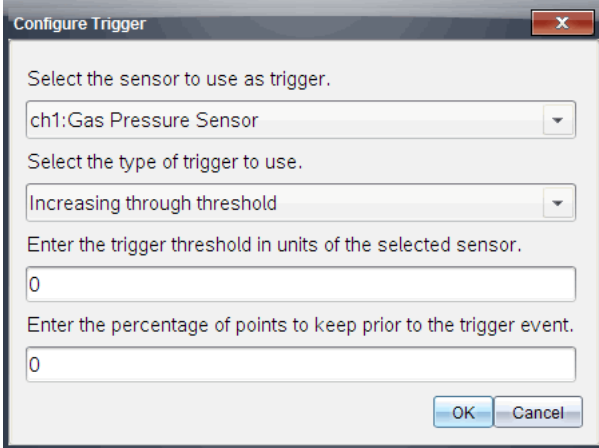

Configure Trigger

Select the sensor to use as trigger.

ch1:Gas Pressure Sensor

Select the type of trigger to use.

Increasing through threshold

Enter the trigger threshold in units of the selected sensor.

0

Enter the percentage of points to keep prior to the trigger event.

0

OK Cancel

3. Select the sensor from the **Select the sensor to use as trigger** drop-down list.  
**Note:** The menu displays the sensors connected to the TI-Nspire™ Lab Cradle.
4. Select one of the following from the **Select the type of trigger to use** drop-down list.
  - **Increasing through threshold.** Use to trigger on increasing values.
  - **Decreasing through threshold.** Use to trigger on decreasing values.
5. Type the appropriate value in the **Enter the trigger threshold in units of the selected sensor** field.

When entering the trigger value, enter a value within the range of the sensor.

If you change the unit type after setting the threshold, the value automatically updates.

For example, if you use the Vernier Gas Pressure sensor with the units set as atm and you later change the units to kPa, the settings are updated.

6. Type the number of data points to keep before the trigger value occurs.
7. Click **OK**.

The trigger is now set and enabled if values were entered.

8. (Optional) Select **Experiment > Advanced Set up > Triggering** to verify the active indicator is set to Enabled.

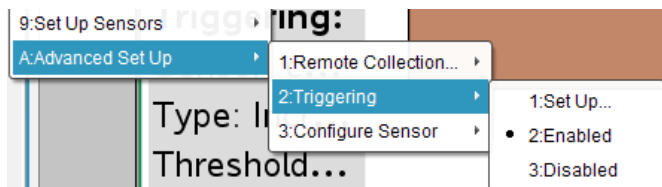

**Important:** When the trigger is enabled, it stays active until it is disabled or you start a new experiment.

### Enabling a Disabled Trigger

If you set the trigger values in the current experiment, and then disable them, you can enable the triggers again.

To enable a trigger:

- ▶ Click **Experiment > Advanced Set Up > Triggering > Enable**.

### Disabling an Enabled Trigger

To disable the active trigger.

- ▶ Click **Experiment > Advanced Set Up > Triggering > Disable**.

## Collecting and Managing Data Sets

By default, the **Start Collection** button  overwrites collected data with data from the next run. To preserve each run, you can store it as a data set. After collecting multiple data sets, you can superimpose any combination of them on the Graph View.

**Important:** Stored data sets are lost if you close the document without saving it. If you want stored data to be available later, make sure to save the document.

### Storing Data as Sets

1. Collect the data from the first run. (See [Collecting Data](#).)
2. Click the **Store Data Set** button .



The data is stored as **run1**. A new data set, **run2**, is created for collecting the next run.

3. Click **Start Collection**  to collect data for **run2**.

## Comparing Data Sets

1. Click the **Graph View** icon  to show the graph.
2. Click the Data Set Selector (near the top of the Detail View) to expand the list of data sets.

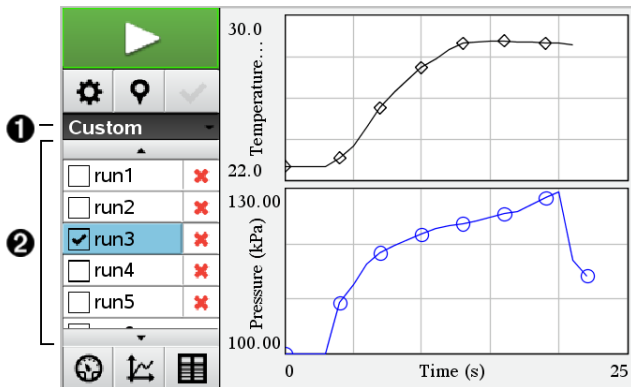

- 1 Data Set Selector lets you expand or collapse the list.
  - 2 Expanded list shows available data sets. Scroll buttons appear as necessary to let you scroll the list.
3. Choose which data sets to view by selecting or clearing the check boxes.

The graph is rescaled as necessary to show all selected data.

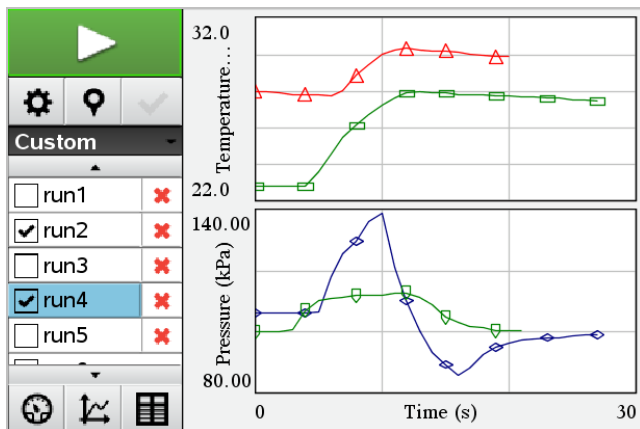



**Tip:** To quickly select a single data set, hold down **Shift** while clicking its name in the list. The graph shows only the selected set, and the list is collapsed automatically to help you view details of the data.

### Renaming a Data Set

By default, data sets are named **run1**, **run2**, and so on. The name of each data set is displayed in the Table view.

1. Click the **Table View** icon  to show the table.
2. Display the context menu for the table view, and select **Data Set Options** > [*current name*].

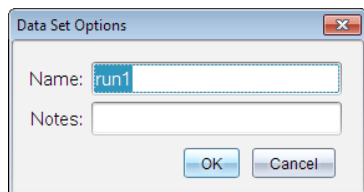

3. Type the new **Name**.

**Note:** The maximum character limit is 30. The name cannot contain commas.

4. (Optional) Type **Notes** about the data.

### Deleting a Data Set

1. Click the **Graph View** icon  to show the graph.
2. Click the Data Set Selector (near the top of the Detail View) to expand the list of data sets.
3. Scroll the list as necessary, and then click the Delete symbol (**X**) next to the name of the data set.

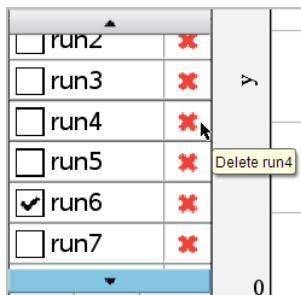

- Click **OK** on the confirmation message.

### Expanding the View Details Area

- ▶ Drag the boundary at the right edge of the Details area to increase or decrease its width.

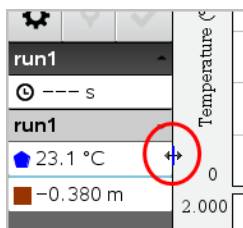

### Using Sensor Data in Programs

You can access sensor data from all connected sensor probes through your TI-Basic program by using this command:

*RefreshProbeVars statusVar*

- You must first launch the Vernier DataQuest™ application, or you will receive an error. 

**Note:** The Vernier DataQuest™ application will auto-launch when you connect a sensor or a lab cradle to the TI-Nspire™ software or handheld.

- The *RefreshProbeVars* command will be valid only when Vernier DataQuest™ is in 'meter' mode. 
- *statusVar* is an optional parameter that indicates the status of the command. These are the *statusVar* values:

StatusVar Value	Status
<i>statusVar</i> =0	Normal (continue with the program)
<i>statusVar</i> =1	The Vernier DataQuest™ application is in data collection mode. <b>Note:</b> The Vernier DataQuest™ application must be in meter mode for this command to work. 
<i>statusVar</i> =2	The Vernier DataQuest™ application is not launched.

StatusVar Value	Status
<i>statusVar</i> =3	The Vernier DataQuest™ application is launched, but you have not connected any probes.

- Your TI-Basic program will read directly from Vernier DataQuest™ variables in the symbol table.
- The *meter.time* variable shows the last value of the variable; it does not update automatically. If no data collection has occurred, *meter.time* will be 0 (zero).
- Use of variable names without corresponding probes being physically attached will result in a "Variable not defined" error.

### ***Collecting Sensor Data using RefreshProbeVars***

1. Launch the Vernier DataQuest™ application.
2. Connect the sensor(s) you need to collect the data.
3. Run the program you wish to use to collect data in the calculator application.
4. Manipulate the sensors and collect the data.

**Note:** You may create a program to interact with the TI-Innovator™ Hub using  > **Hub > Send**. (See Example 2, below.) This is optional.

#### **Example 1**

```
Define temp()=
Prgm
© Check if system is ready
RefreshProbeVars status
If status=0 Then
Disp "ready"
For n,1,50
RefreshProbeVars status
temperature:=meter.temperature
Disp "Temperature: ",temperature
If temperature>30 Then
Disp "Too hot"
EndIf
© Wait for 1 second between samples
Wait 1
EndFor
Else
Disp "Not ready. Try again later"
EndIf
EndPrgm
```

#### **Example 2 - with TI-Innovator™ Hub**

```
Define tempwithhub()=
Prgm
© Check if system is ready
RefreshProbeVars status
If status=0 Then
```

```

Disp "ready"
For n,1,50
RefreshProbeVars status
temperature:=meter.temperature
Disp "Temperature: ",temperature
If temperature>30 Then
Disp "Too hot"
© Play a tone on the Hub
Send "SET SOUND 440 TIME 2"
EndIf
© Wait for 1 second between samples
Wait 1
EndFor
Else
Disp "Not ready. Try again later"
EndIf
EndPrgm

```

## **Analyzing Collected Data**

In the Vernier DataQuest™ application, use Graph View to analyze data. Start by setting up graphs, and then use analysis tools such as integral, statistics, and curve fit to investigate the mathematical nature of the data.

**Important:** The Graph menu and Analyze menu items are only available when working in Graph View.

### **Finding the Area Under a Data Plot**

Use Integral to determine the area under a data plot. You can find the area under all of the data or a selected region of the data.

To find the area under a data plot:

1. Leave the graph unselected to examine all the data, or select a range to examine a specific area.
2. Click **Analyze > Integral**.
3. Select the plotted column name if you have more than a single column.

The data plot area is displayed in the View Details area.

### **Finding the Slope**

Tangent displays a measure of the rate at which the data is changing at the point you are examining. The value is labeled "Slope."

To find the slope:

1. Click **Analyze > Tangent**.

A check mark appears in the menu next to the option.

2. Click the graph.

The examine indicator is drawn to the nearest data point.

The values of the plotted data are shown in the View details area and the All Details for Graph dialog box.

You can move the examine line by dragging, clicking another point, or using the arrow keys.

### **Interpolating the Value Between Two Data Points**

Use Interpolate to estimate the value between two data points and to determine the value of a Curve Fit between and beyond these data points.

The examine line moves from data point to data point. When Interpolate is on, the examine line moves between and beyond data points.

To use Interpolate:

1. Click **Analyze > Interpolate**.

A check mark appears in the menu next to the option.

2. Click the graph.

The examine indicator is drawn to the nearest data point.

The values of the plotted data are shown in the View Details area.

You can shift the examine line by moving the cursor with the arrow keys or by clicking on another data point.

### **Generating Statistics**

You can generate statistics (minimum, maximum, mean, standard deviation, and number of samples) for all the collected data or for a selected region. You can also generate a curve fit based on one of several standard models or on a model that you define.

1. Leave the graph unselected to examine all the data, or select a range to examine a specific area.
2. Click **Analyze > Statistics**.

3. Select the plotted column name if you have more than a single column. For example, run1.Pressure.

The Stats dialog box opens.

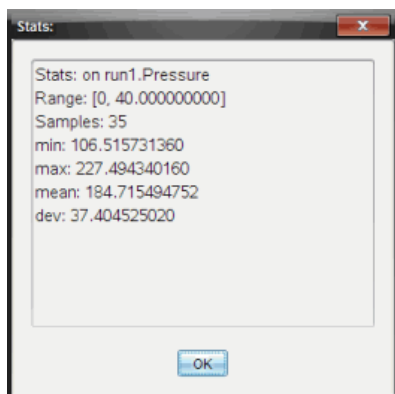

4. Review the data.
5. Click **OK**.

For information on clearing the Statistics analysis, see *Removing Analysis Options*.

### Generating a Curve Fit

Use Curve Fit to find the best curve fit to match the data. Select all of the data or a selected region of data. The curve is drawn on the graph.

1. Leave the graph unselected to examine all the data, or select a range to examine a specific area.
2. Click **Analyze > Curve Fit**.
3. Select a curve fit option.

Curve Fit option	Calculated in the form:
Linear	$y = m*x + b$
Quadratic	$y = a*x^2 + b*x + c$
Cubic	$y = a*x^3 + b*x^2 + c*x + d$

Curve Fit option	Calculated in the form:
Quartic	$y = a*x^4 + b*x^3 + c*x^2 + d*x + e$
Power ( $ax^b$ )	$y = a*x^b$
Exponential ( $ab^x$ )	$y = a*b^x$
Logarithmic	$y = a + b*\ln(x)$
Sinusoidal	$y = a*\sin(b*x + c) + d$
Logistic ( $d \neq 0$ )	$y = c/(1 + a*e^{-(b*x)}) + d$
Natural Exponential	$y = a*e^{-(c*x)}$
Proportional	$y = a*x$

The Fit Linear dialog box opens.

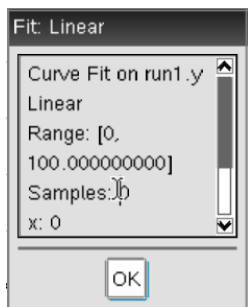

4. Click **OK**.
5. Review the data.

For information on clearing the Curve Fit analysis, see *Removing Analysis Options*.

### Plotting a Standard or User-Defined Model

This option provides a manual method for plotting a function to fit data. Use one of the predefined models or enter your own.

You can also set the spin increment to use in the View Details dialog box. Spin increment is the value by which the coefficient changes when you click the spin buttons in the View Details dialog box.

For example, if you set  $m1=1$  as the spin increment, when you click the up spin button the value changes to 1.1, 1.2, 1.3 and so on. If you click the down spin button, the value changes to 0.9, 0.8, 0.7, and so on.

1. Click **Analyze > Model**.

The Model dialog box opens.

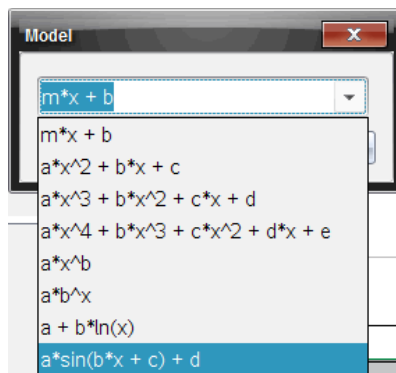

2. Type your own function.

—or—

Click to select a value from the drop-down list.

3. Click **OK**.

The Set Coefficient Values dialog box opens.



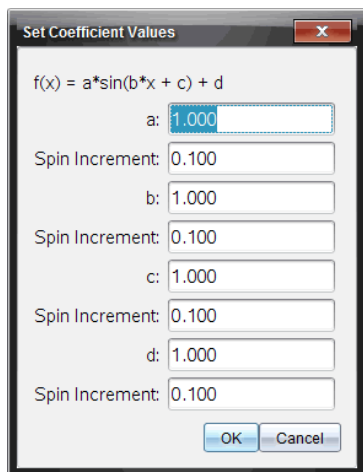

4. Type the value for the variables.
5. Type the change in value in the Spin Increment fields.
6. Click **OK**.

**Note:** These values are the initial values. You can also adjust these values in the View Details area.

The model is shown on the graph with adjustment options in the View Details area and in the All Details for Graph dialog box.

7. (Optional) Adjust the window setting for minimum and maximum axis values. For more information, see *Setting the Axis for One Graph*.

For information on clearing the Model analysis, see *Removing Analysis Options*.

8. Click  to make any desired adjustments to the coefficients.

—or—

Click the value in the View Details area.

This graphic is an example of a model with adjusted values.

### Removing Analysis Options

1. Click **Analyze > Remove**.
2. Select the data display you want to remove.

The display you selected is removed from the graph and the View Details area.

## ***Displaying Collected Data in Graph View***

When you collect data, it is written in both the Graph and Table views. Use the Graph view to examine the plotted data.

**Important:** The Graph menu and Analyze menu items are only active when working in Graph View.

### **Selecting the Graph View**

- ▶ Click the **Graph View** tab .

### **Viewing Multiple Graphs**

Use the Show Graph menu to show separate graphs when using:

- A sensor that plots more than one column of data.
- Multiple sensors with different defined units at the same time.

In this example, two sensors (the Gas Pressure sensor and the Hand Dynamometer) were used in the same run. The following image shows the columns Time, Force, and Pressure in the Table view to illustrate why two graphs are shown.

### ***Displaying One of Two Graphs***

When two graphs are displayed, the top graph is Graph 1 and the bottom graph is Graph 2.

To display only Graph 1:

- ▶ Select **Graph > Show Graph > Graph 1.**

Only Graph1 is displayed.

To display only Graph 2:

- ▶ Select **Graph > Show Graph > Graph 2.**

Only Graph 2 is displayed.

### ***Displaying Both Graphs***

To display both Graph 1 and Graph 2 together:

- ▶ Select **Graph > Show Graph > Both.**

Graph1 and Graph 2 are displayed.

## Displaying Graphs in the Page Layout View

Use the Page layout view when Show Graph is not the appropriate solution for showing more than one graph.

The Show Graph option is not applicable for:

- Multiple runs using a single sensor.
- Two or more of the same sensors.
- Multiple sensors that use the same column(s) of data.

To use Page Layout:

1. Open the original data set you want to see in two graph windows.
2. Click **Edit > Page Layout > Select Layout**.
3. Select the type of page layout you want to use.
4. Click **Click here to add an application**.
5. Select **Add Vernier DataQuest™**.

The Vernier DataQuest™ application is added to the second view.

6. To see separate views, click the view you want to change, and then select **View > Table**.

The new view is displayed.

7. To show the same view, click the view to change.
8. Click **View > Graph**.

The new view is displayed.

## Displaying Collected Data in Table View

Table view provides another way to sort and view collected data.

### Selecting the Table View

- ▶ Click the **Table View** tab .

### Defining Column Options

You can name columns and define the decimal points and the precision you want to use.

1. from the **Data** menu, select **Column Options**.

**Note:** You can be in the Meter, Graph, or Table view and still click these menu options. The results will still be visible.

2. Click the name of the column you want to define.

The Column Options dialog box opens.

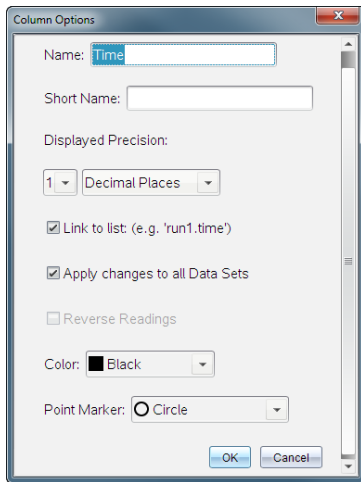

3. Type the long name for the column in the **Name** field.
4. Type the abbreviated name in the **Short Name** field.

**Note:** This name is displayed if the column cannot expand to display the full name.

5. Type the number of units in the **Units** field.
6. From the **Displayed Precision** drop-down list, select the precision value.

**Note:** The default precision is related to the precision of the sensor.

7. Select **Link to list** to link to the symbol table and make this information available to other TI-Nspire™ applications.

**Note:** Linking is the default for most sensors.

**Important:** Heart rate and blood pressure sensors require a tremendous amount of data to be useful, and the default for these sensors is to be unlinked to improve system performance.

8. Select **Apply changes to all Data Sets** to apply these settings to all data sets.
9. Click **OK**.

The column settings are now defined with the new values.

## Creating a Column of Manually Entered Values

To enter data manually, add a new column. Sensor columns cannot be modified, but data entered manually can be edited.

1. Click **Data > New Manual Column**.

The Column Options dialog box opens.

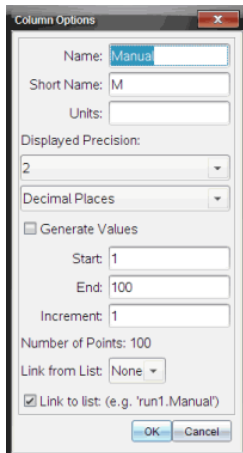

2. Type the long name for the column in the **Name** field.
3. Type the abbreviated name in the **Short Name** field.

**Note:** This name is displayed if the column cannot expand to display the full name.

4. Type the units to be used.
5. From the **Displayed Precision** drop-down list, select the precision value.

**Note:** The default precision is related to the precision of the sensor.

6. (Optional) Select **Apply changes to all Data Sets** to apply these settings to all data sets.
7. (Optional) Select **Generate Values** to automatically populate the rows.

If you select this option, complete these steps:

- a) Type a starting value in the **Start** field.
- b) Type an ending value in the **End** field.

- c) Type the increase in value in the **Increment** field.

The number of points is calculated and shown in the Number of Points field.

8. Select **Link from list** to link to data in another TI-Nspire™ application.

**Note:** This list only populates when data exists in the other application and includes a column label.

9. Select **Link to list** to link to the symbol table and make this information available to other TI-Nspire™ applications.

**Note:** Linking is the default for most sensors.

**Important:** Heart rate and blood pressure sensors require a tremendous amount of data to be useful, and the default for these sensors is to be unlinked to improve system performance.

10. Click **OK**.

A new column is added to the table. This column can be edited.

### Creating a Column of Calculated Values

You can add an additional column to the data set in which the values are calculated from an expression using at least one of the existing columns.

Use a calculated column when finding the derivative for pH data. For more information, see *Adjusting Derivative Settings*.

1. Click **Data > New Calculated Column**.

The Column Options dialog box opens.

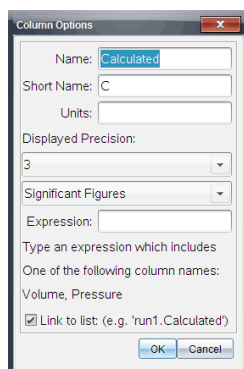

Column Options

Name:

Short Name:

Units:

Displayed Precision:

Significant Figures:

Expression:

Type an expression which includes  
One of the following column names:  
Volume, Pressure

Link to list: (e.g. 'run1.Calculated')

2. Type the long name for the column in the **Name** field.

3. Type the abbreviated name in the **Short Name** field.

**Note:** This name is displayed if the column cannot expand to display the full name.

4. Type the units to be used.

5. From the **Displayed Precision** drop-down list, select the precision value.

**Note:** The default precision is related to the precision of the sensor.

6. Type a calculation including one of the column names in the **Expression** field.

**Note:** The system-provided column names are dependent on the sensor(s) selected and any changes made to the name field in Column Options.

**Important:** The Expression field is case-sensitive. (Example: "Pressure" is not the same as "pressure.")

7. Select **Link to list** to link to the symbol table and make this information available to other TI-Nspire™ applications.

**Note:** Linking is the default for most sensors.

**Important:** Heart rate and blood pressure sensors require a tremendous amount of data to be useful, and the default for these sensors is to be unlinked to improve system performance.

8. Click **OK**.

The new calculated column is created.

## ***Customizing the Graph of Collected Data***

You can customize the Graph view by adding a title, changing colors, and setting ranges for the axis.

### **Adding a Title**

When you add a title to a graph, the title is displayed in the View Details area. When you print the graph, the title prints on the graph.

1. Click **Graph > Graph Title**.

The Graph Title dialog box opens.

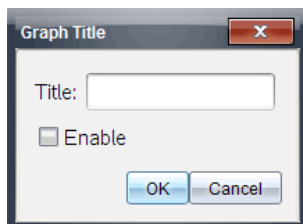

If there are two graphs in the work area, the dialog box has two title options.

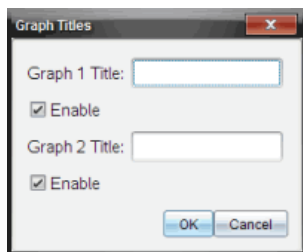

2. Type the name of the graph in the Title field.

—or—

- a) Type the name of the first graph in the Graph 1 field.
  - b) Type the name of the second graph in the Graph 2 field.
3. Select **Enable** to show the title.

**Note:** Use the Enable option to hide or show the graph title as needed.

4. Click **OK**.

The title is shown.

## Setting Axis Ranges

### *Setting Axis Ranges for One Graph*

To modify the minimum and maximum range for the x and y axis:

1. Click **Graph > Window Settings**.

The Window Settings dialog box opens.



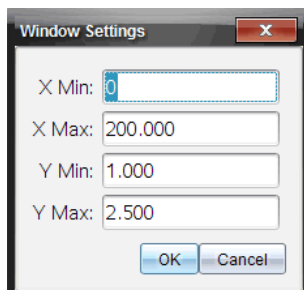

2. Type the new values in one or more of these fields:

- X Min
- X Max
- Y Min
- Y Max

3. Click **OK**.

The application uses the new values for the graph visual range until you modify the range or change data sets.

### ***Setting Axis Ranges for Two Graphs***

When working with two graphs, enter two y axis minimum and maximum values, but only one set of minimum and maximum values for the x axis.

1. Click **Graph > Window Setting**.

The Window Setting dialog box opens.

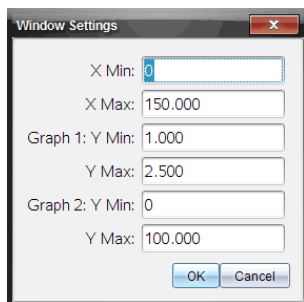

2. Type the new values in one or more of these fields:

- X Min

- X Max
- Graph 1: Y Min
- Y Max
- Graph 2: Y Min
- Y Max

3. Click **OK**.

The application uses the new values for the graph visual range until you modify the range or change data sets.

### **Setting the Axis Range on the Graph Screen**

You can modify the minimum and maximum range for the x and y axes directly on the graph screen.

- ▶ Select the axis value that you want to change, and type a new value.

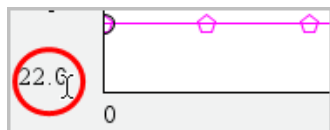

The graph is redrawn to reflect the change.

### **Selecting which Data Sets to Plot**

1. In the Detail view on the left, click the tab immediately below the view selection buttons.

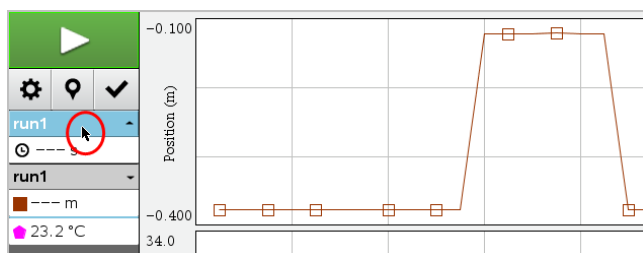

2. The Detail view shows a list of available data sets.
3. Use the check boxes to select the data sets to plot.

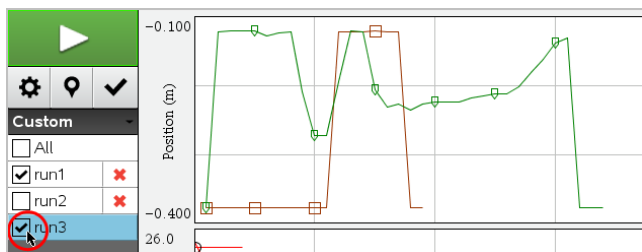

## Autoscaling a Graph

Use the autoscale option to show all the points plotted. Autoscale Now is useful after you change the x and y axis range or zoom in or out of a graph. You can also define the automatic autoscale setting to use during and after a collection.

### *Autoscale Now Using the Application Menu*

- ▶ Click **Graph > Autoscale Now**.

The graph now displays all the points plotted.

### *Autoscale Now Using the Context Menu*

1. Open the context menu in the graph area.
2. Click **Window/Zoom > Autoscale Now**.

The graph now displays all the points plotted.

### *Defining Autoscale During a Collection*

There are two options for using the automatic autoscaling that occurs during a collection. To choose an option:

1. Click **Options > Autoscale Settings**.

The Autoscale Settings dialog box opens.

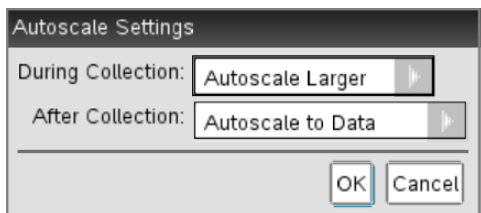

2. Click ► to open the During Collection drop-down list.
3. Select one of these options:
  - **Autoscale Larger** - Expands the graph as needed to show all points as you collect them.
  - **Do Not Autoscale** - The graph is not changed during a collection.
4. Click **OK** to save the setting.

### ***Defining Autoscale After a Collection***

You have three options for setting the automatic autoscaling that occurs after a collection. To set your choice:

1. Click **Options > Autoscale Settings**.

The Autoscale Settings dialog box opens.

2. Click ► to open the **After Collection** drop-down list.
3. Select one of these options:
  - **Autoscale to Data**. Expands the graph to show all data points. This option is the default mode.
  - **Autoscale From Zero**. Modifies the graph so all data points including the origin point are displayed.
  - **Do Not Autoscale**. The graph settings are not changed.
4. Click **OK** to save the setting.

### **Selecting a Range of Data**

Selecting a range of data on the graph is useful in several situations, such as when zooming in or out, striking and unstriking data, and examining settings.

### **To select a range:**

1. Drag across the graph.

The selected area is indicated by gray shading.

2. Perform one of these actions.

- Zoom in or out
- Strike or unstrike data
- Examine settings

### **To deselect a range:**

- ▶ Press the **Esc** key as necessary to remove the shading and the vertical trace line.

### **Zooming In on a Graph**

You can zoom in on a subset of the collected points. You can also zoom out from a previous zoom or expand the graph window beyond the data points collected.

To zoom in on a graph:

1. Select the area you want to zoom into, or use the current view.
2. Click **Graph > Zoom In**.

The graph adjusts to display only the area you selected.

The x range selected is used as the new x range. The y range autoscales to show all graphed data points in the selected range.

### **Zooming Out of a Graph**

- ▶ Select **Graph > Zoom Out**.

The graph is now expanded.

If a Zoom In precedes a Zoom Out, the graph displays the original settings prior to the Zoom In.

For example, if you Zoomed In twice, the first Zoom Out would display the window of the first Zoom In. To display the full graph with all data points from multiple zoom ins, use Autoscale Now.

### **Setting Point Options**

To indicate how often marks show on the graph and whether to use a connecting line:

1. Click **Options > Point Options**.

The Point Options dialog box opens.

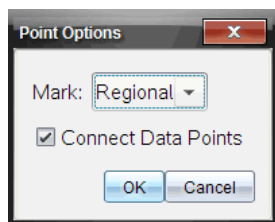

2. Select a **Mark** option from the drop-down list.
  - **None**. No point protectors.
  - **Regional**. Periodic point protectors.
  - **All**. Every data point as a point protector.
3. Select **Connect Data Points** to display a line between points.

—or—

Clear **Connect Data Points** to remove the line between points.

The following graphics show examples of some of the Point Mark options.

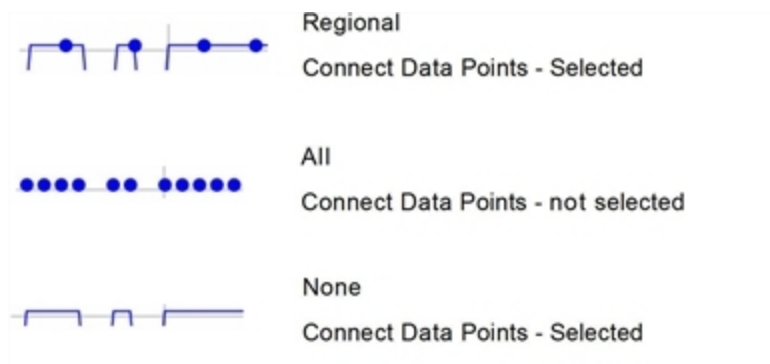

### Changing a Graph's Color

1. Click the point indicator for the graph whose color you want to change.

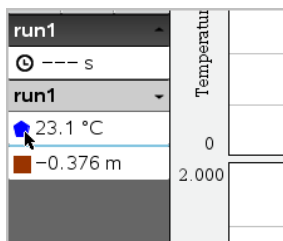

- In the Column Options dialog box, select the new **Color**.

### Selecting Point Markers

- Right-click in the graph to open the menu.
- Click **Point Marker**.

**Note:** If there is only one dependent variable column, the Point Marker option is preceded by the data set name and column name. Otherwise, the Point Marker option has a menu.

- Select the column variable to change.
- Select the point marker to set.

The Point Marker changes to the option selected.

### Selecting an Independent Variable Column

Use the option Select X-axis Column to select the column used as the independent variable when graphing the data. This column is used for all graphs.

- Click **Graph > Select X-axis Column**.
- Select the variable you want to change.

The x-axis label on the graph changes and the graph is reordered using the new independent variable for graphing the data.

### Selecting a Dependent Variable Column

Use the option Select Y-axis Column to select which dependent variable columns to plot on the displayed graph(s).

- Click **Graph > Select Y-axis Column**.
- Select one of the following:

- A variable from the list. The list is a combination of dependent variables and the number of data sets.
- **More.** Selecting More opens the Select dialog box. Use this when you want to select a combination of data set variables to graph.

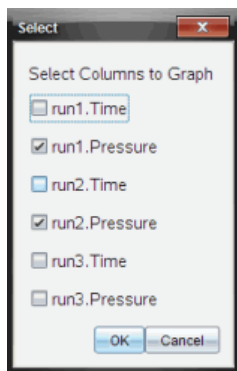

### Showing and Hiding Details

You can hide or show the Details view on the left side of the screen.

- Click **Options > Hide Details** or **Options > Show Details**.

### Showing and Hiding Axes Tick Labels

You can hide or show the axes tick labels on a graph.

- Click **Options > Hide tick labels** or **Options > Show tick labels**.

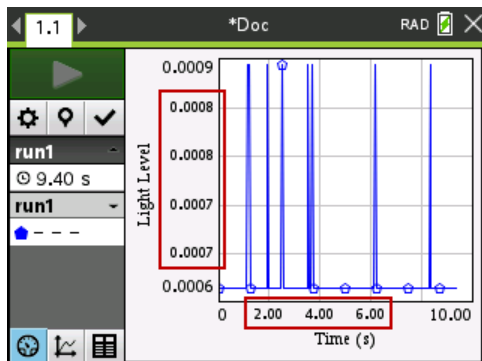

**Notes:**



- When a Vernier DataQuest™ application is added to a document, the tick labels will default to being displayed.
- Tick labels may not be displayed if there is a lack of available space. Minimum and maximum values will always be displayed.
- Tick labels cannot be edited, but they will recalculate as needed if the minimum or maximum values are edited or the window settings are changed.

## ***Striking and Restoring Data***

Striking data omits it temporarily from the Graph view and from the analysis tools.

1. Open the data run that contains the data to be struck.
2. Click **Table View** .
3. Select the region by dragging from the starting row to the ending point.

The screen scrolls so you can see the selection.

4. Click **Data > Strike Data**.
5. Select one of the following:
  - **In Selected Region**. Strike the data from the area you selected.
  - **Outside Selected Region**. Strike all data except the area you selected.

The selected data is marked as struck in the table and is removed from the graph view.

### **Restoring Struck Data**

1. Select the range of data to restore or if restoring all struck data, start at step two.
2. Click **Data > Restore Data**.
3. Select one of the following:
  - **In Selected Region** - Restore data in the selected area.
  - **Outside Selected Region** - Restore data outside the selected area.
  - **All Data** - Restore all data. No data selection necessary.

The data is restored.

## ***Replaying the Data Collection***

Use the Replay option to playback the data collection. This option lets you:

- Select the data set you want to replay.
- Pause the playback.
- Advance the playback by one point at a time.
- Adjust the playback rate.
- Repeat the playback.

## Selecting the Data Set to Replay

You can replay one data set at a time. By default, the latest data set plays using the first column as the base column (example: time reference).

If you have multiple data sets, and want a different data set or base column than the default, you can select the data set to replay and the base column.

To select the data set to replay:

1. Click **Experiment > Replay > Advanced Settings**.

The Advanced Replay Settings dialog box opens.

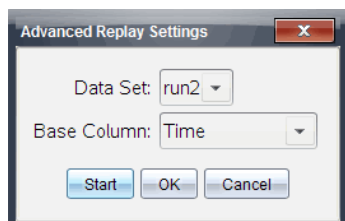

2. Select the data set to replay from the Data Set drop-down list.

**Note:** Changing the run in the Data Set selection tool does not affect the playback choice. You must specify which data set in **Experiment > Replay > Advance Settings**.

3. (Optional) Select a new value from the Base Column drop-down list.

The selected column acts as the “Time” column for the replay.

**Note:** The base column should be a strictly increasing list of numbers.

4. Click **Start** to start the playback and save the settings.

**Note:** Data Set and Base Column options are based on the number of stored runs and the sensor type used.

## Starting and Controlling the Playback

- ▶ Select **Experiment > Replay > Start Playback**.

Playback begins, and the Data Collection Control buttons change to:



Pause



Resume



Stop



Advance by One Point (enabled only during pause)

## Adjusting the Playback Rate

To adjust the playback rate:

1. Select **Experiment > Replay > Playback Rate**.

The Playback Rate dialog box opens.

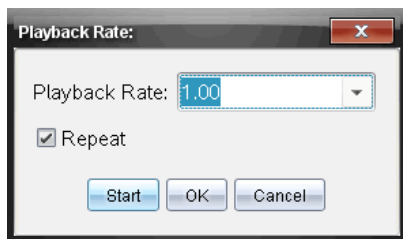

2. In the Playback Rate field, click ▼ to open the drop-down list.
3. Select the rate at which the playback will play.

Normal speed is 1.00. A higher value is faster, and a lower value is slower.

4. Select one of the following options:
  - Click **Start** to start the playback and save the settings.
  - Click **OK** to save the settings for use on the next playback.

## Repeating the Playback

1. Select **Experiment > Replay > Start Playback**.
2. Click **Start** to start the playback and save the settings.

## Adjusting Derivative Settings

Use this option to select the number of points to use in derivative calculations. This value affects the tangent tool, velocity, and acceleration values.

Find pH derivative settings using a calculated column.

The Vernier DataQuest™ application can determine a numeric derivative from a list of data with respect to another list of data. The data can be collected using sensors, input manually, or linked with other applications. The numerical derivative is found using a calculated column.

To determine the numerical 1st derivative of List B with respect to List A, enter the following expression in the Column Options dialog:

**derivative(B,A,1,0) or derivative(B,A,1,1)**

To determine the numerical 2nd derivative of List B with respect to List A, enter the following express:

**derivative(B,A,2,0) or derivative(B,A,2,1)**

The last parameter is either 0 or 1 depending on the method you are using. When it is 0, a weighted average is used. When it is 1, a time shifted derivative method is used.

**Note:** The first derivative calculation (weighted average) is what the Tangent tool uses to display the slope at a data point when examining data. (Analyze > Tangent).

**Note:** The derivative calculation is completely row based. It is recommended that your List A data be sorted in ascending order.

1. Click **Options > Derivative Settings**.

The Settings dialog box opens.

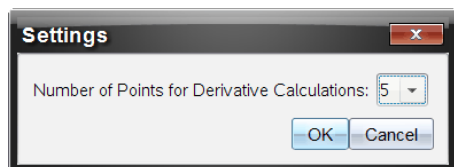

2. Select the number of points from the drop-down list.
3. Click **OK**.

## ***Drawing a Predictive Plot***

Use this option to add points to the graph to predict the outcome of an experiment.

1. Click the **Graph View** tab .
2. From the **Analyze** menu, select **Draw Prediction > Draw**.
3. Click each area in which you want to place a point.
4. Press **Esc** to release the drawing tool.

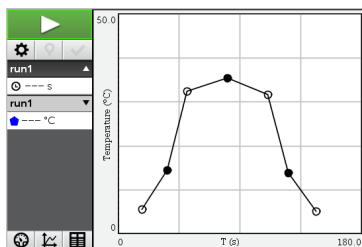

5. To clear the drawn prediction, click **Analyze > Draw Prediction > Clear**.

## ***Using Motion Match***

Use this option to create a randomly generated plot when creating position-versus-time or velocity-versus-time graphs.

This feature is only available when using a motion detector such as the CBR 2™ sensor or the Go!Motion® sensor.

### **Generating a Motion Match Plot**

To generate a plot:

1. Attach the motion detector.
2. Click **View > Graph**.
3. Click **Analyze > Motion Match**.
4. Select one of the following options:
  - **New Position Match**. Generates a random position plot.
  - **New Velocity Match**. Generates a random velocity plot.

**Note:** Continue selecting a new position or a new velocity match to generate a new random plot without removing the existing plot.

### **Removing a Motion Match Plot**

To remove the generated plot:

- ▶ Click **Analyze > Motion Match > Remove Match**.

## ***Printing Collected Data***

You can only print from the computer. You can print any single displayed active view, or with the Print All option:

- One data view.
- All of the data views.
- A combination of the data views.

The Print All option has no effect on applications outside of the Vernier DataQuest™ application.

### **Printing Data Views**

To print a data view:

1. On the main menu (top of the window), click **File > Print**.

The Print dialog box opens.

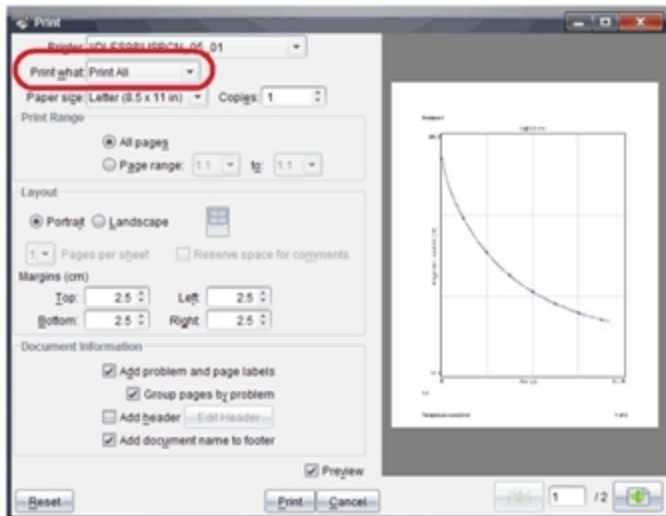

2. Select **Print All** from the Print what drop-down list.
3. Select additional options, if needed.
4. Click **Print** to send the document to the printer.

### Setting Options for the Print All Feature

1. Click **Options > Print All Settings**.

The Print All Settings dialog box opens.

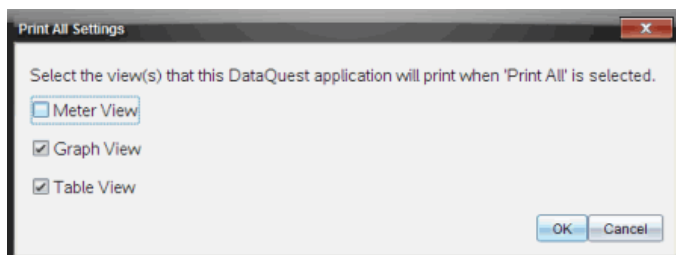

2. Select the views you want to print.
  - **Print Current View.** The current view is sent to the printer.
  - **Print All Views.** All three views (Meter, Graph, and Table) are sent to the printer.
  - **More.** Only the views you select are sent to the printer.

3. Click **OK**.

The Print All Settings are now complete and can be used when printing.

# Widgets

All work that you create and save using TI-Nspire™ applications is stored as a document, which you can share with others using TI-Nspire™ software, a TI-Nspire™ CX II handheld, or the TI-Nspire™ App for iPad®. You save these TI-Nspire™ documents as .tns files.

A Widget is a .tns document that is stored in your MyWidgets folder.

You can use Widgets to:

- Easily access text files
- Insert and run scripts (such as the pre-loaded widget example: Stopwatch.tns)
- Quickly insert a saved problem into a document

When you add a Widget, TI-Inspire™ CX extracts only the first page of the selected .tns file, and inserts it into your open document.

## ***Creating a Widget***

A document is regarded as a Widget when it is saved or copied to the designated MyWidgets folder. The default location is:

- Windows®: My Documents\TI-Nspire\MyWidgets.
- Mac®: Documents/TI-Nspire/MyWidgets.
- Handheld: MyWidgets
- TI-Nspire™ App for iPad® and TI-Nspire™ CAS App for iPad®: MyWidgets

If the MyWidget folder has been inadvertently deleted, you must create it before attempting to use a Widget.

**Note:** When you add a Widget, TI-Inspire™ CX extracts only the first page of the selected .tns file, and inserts it into your open document.

## ***Adding a Widget***

### **Adding a Widget to a New Document**

1. Open a new document.



2. Click **Add Widget**.

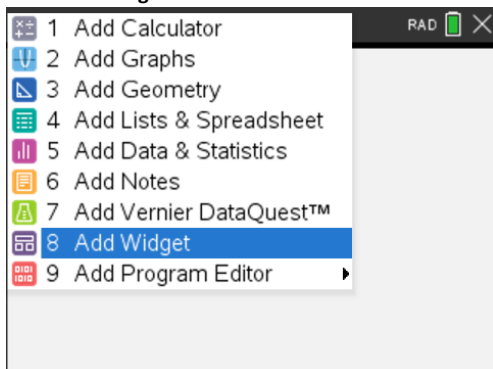

3. Scroll to select a .tns file from the box.

4. Click **Add**.

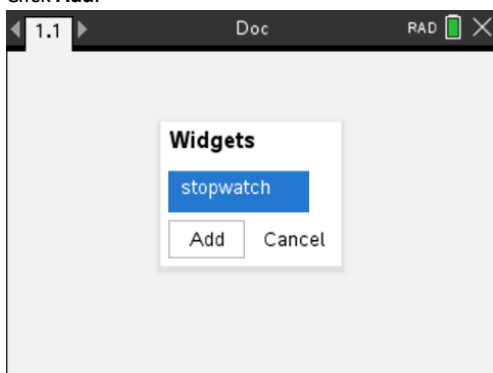

**Note:** Stopwatch is a preloaded .tns file. Any saved .tns file will show up in this list.

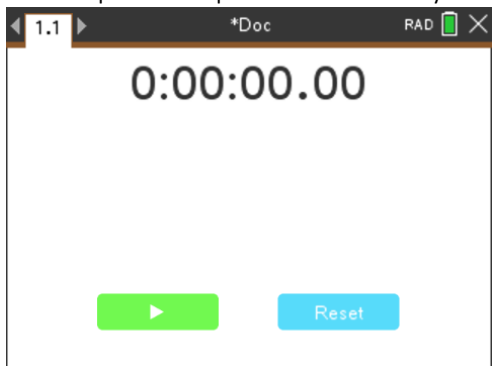

## Adding a Widget to an Existing Document

1. Click **Doc > Insert > Widget**.

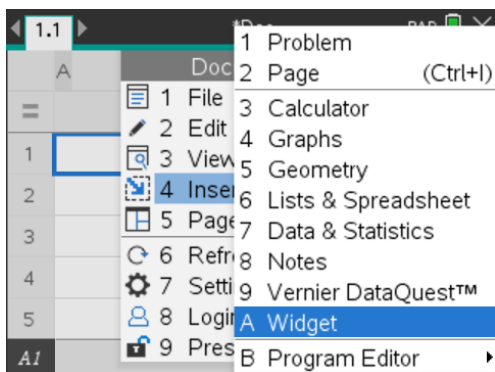

2. Click **Add**.

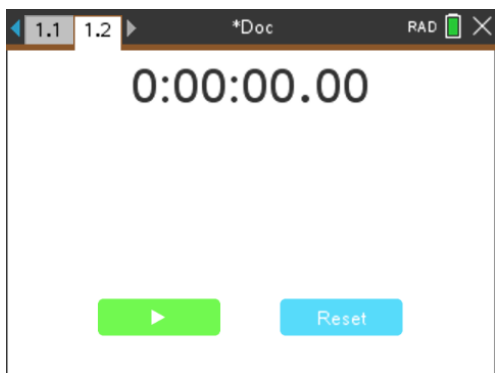
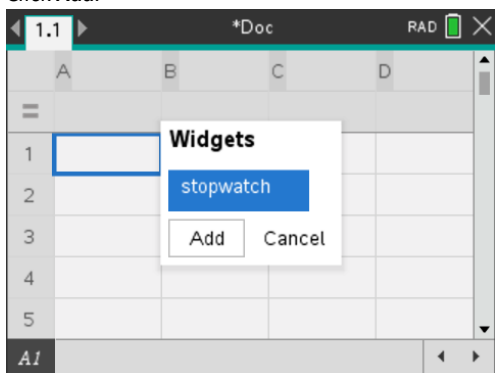

**Note:** You can also add a Widget to a new or existing document using the **Insert** menu.

## ***Saving a Widget***

1. Click .
2. Navigate to MyDocuments > MyWidgets.
3. Type in a name for your Widget.

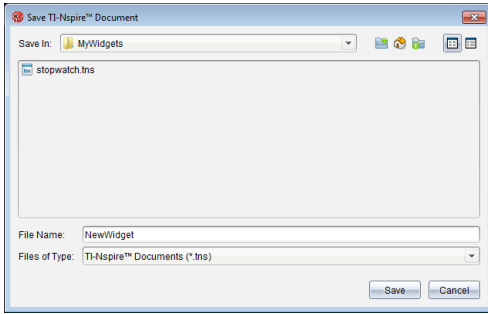

4. Click **Save**.

## Libraries

A library is a TI-Nspire™ document that contains a collection of variables, functions, and/or programs that have been defined as library objects.

Unlike ordinary variables, functions, and programs, which can be used only within a single problem (the problem in which they are defined), library objects are accessible from any document. You can even create public library objects that appear in the TI-Nspire™ Catalog.

For example, suppose you have created library document **matrix** containing public library function **diagwithtrace()** and a private library function **errmsg()**.

Function **diagwithtrace()** displays the diagonal of a square matrix and calculates the trace of the matrix. If its input is not a square matrix, the function calls **errmsg()**, which should then return an appropriate error string.

```
Define LibPub diagwithtrace(m)=  
Func  
© diagwithtrace(mat): diagonal with trace  
If rowDim(m)≠colDim(m) Then  
    Return errmsg("not_square")  
Else  
    Disp diag(m)  
    Return trace(m)  
EndIf  
Define LibPriv errmsg(msgcode)=  
Func  
© Private library function errmsg(msgcode)  
...  
If msgcode="not_square" Then  
    Return "Error: matrix is not square"  
EndIf  
...  
EndFunc
```

You could then use the following syntax to display the diagonal and calculate the trace of matrix *m* defined in the current problem:

```
matrix\diagwithtrace(m)
```

### ***Creating Libraries and Library Objects***

A document is regarded as a library when it is saved or copied to the designated library folder. The default location is:

- Windows®: My Documents\TI-Nspire\MyLib.
- Mac®: Documents/TI-Nspire/MyLib.
- Handheld: MyLib

If the folder has been inadvertently deleted, you must create it before attempting to use libraries.

You can define library objects using either the Program Editor or the Calculator application. Library objects must be defined with a **Define** command and must reside in the first problem of a library document.

**Note:** If you use the Program Editor to define a library function or program, you must store the object and also save the document. Saving the document does not automatically store the object. For more information, see *Programming*.

Naming restrictions apply to library documents and library objects.

- A library document name must be a valid variable name between 1 and 16 characters long, and it must not contain a period or begin with an underscore.
- A library object name must be a valid variable name between 1 and 15 characters long. It must not contain a period and must not begin with an underscore.

### ***Private and Public Library Objects***

When you define a library object, you designate it as private (LibPriv) or public (LibPub).

**Define a=5**

*a* is not a library object.

**Define LibPriv b={1,2,3}**

*b* is a private library object.

**Define LibPub func1(x)=x^2 - 1**

*func1* is a public library object.

A **Private** library object does not appear in the Catalog, but you can access it by typing its name. Private objects serve well as building blocks that perform basic, low-level tasks. Typically, private library objects are called upon by the public functions and programs.

A **Public** library object appears in the Catalog's library tab after you refresh the libraries. You can access a public library object through the Catalog or by typing its name.



Mac® only: In version 1.4 of the software, a library document name cannot contain extended characters, such as Ö, á, or ñ.

**Note:** In library programs and functions defined as public, a comment line (©) immediately following the **Prgm** or **Func** line is automatically displayed as help in the Catalog. You could, for example, show a syntax reminder there.

### **Using Short and Long Names**

Anytime you are in the same problem where an object is defined, you can access it by entering its short name (the name given in the object's **Define** command). This is the case for all defined objects, including private, public, and non-library objects.

You can access a library object from any document by typing the object's long name. A long name consists of the name of the object's library document followed by a backslash "\ " followed by the name of the object. For example, the long name of the

object defined as **func1** in the library document **lib1** is **lib1\func1**. To type the “\” character on the handheld, press  .

**Note:** If you cannot remember the exact name or the order of arguments required for a private library object, you can open the library document or use the Program Editor to view the object. You also can use **getVarInfo** to view a list of objects in a library.



## Using Library Objects

Before using a library variable, function, or program, make sure that these steps have been followed:

- The object has been defined with the **Define** command, and the command specifies either the LibPriv or LibPub attribute.
- The object resides in the first problem of a library document. The document must reside in the designated library folder and must meet the naming requirements.
- If you defined the object using the Program Editor, it has been stored using **Check Syntax & Store** from the Program Editor menu.
- The libraries have been refreshed.

### Refreshing the Libraries

- ▶ Refresh libraries to make the library objects available to your documents.
  - From the **Tools** menu, click **Refresh Libraries**.

Handheld: Press   and click **Refresh Libraries**.

### Using a Public Library Object

1. Refresh the libraries.
2. Open the TI-Nspire™ application in which you want to use the variable, function or program.

**Note:** All applications can evaluate functions, but only the Calculator and Notes applications can run programs.



3. Open the Catalog and use the library tab to find and insert the object.
4. If arguments are required, type them inside the parentheses.

### Using a Private Library Object

1. Refresh the libraries.
2. Open the TI-Nspire™ application in which you want to use the variable, function, or program.

**Note:** All applications can evaluate functions, but only the Calculator and Notes applications can run programs.

3. Type the name of the object, such as **lib1\func1()**.

In case of a function or program, always follow the name with parentheses. To type the “\” character on the handheld, press  .

4. If arguments are required, type them inside the parentheses.

## **Creating Shortcuts to Library Objects**

You can make the objects in a library more easily accessible by using **libShortcut()** to create shortcuts to them. This creates a variable group in the current problem that contains references to all the objects in the specified library document. You can choose to include or exclude the private library objects.

For example, suppose the library document `linalg` contains functions named `clearmat`, `cofactor`, `gausstep`, `help`, `inversestep`, `kernelbasis`, `rank`, and `simultstep`. Executing **libShortcut("linalg", "la")** would create a variable group containing the following members:

```
la.clearmat
la.cofactor
la.gausstep
la.help
la.inversestep
la.kernelbasis
la.rank
la.simultstep
```

You can refer to those library objects from within the current problem by typing their variable names or by selecting them from the Variables menu.

For more details about using **libShortcut()**, see the *Reference Guide*.

## **Included Libraries**

To help you get started with libraries, the TI-Nspire™ Software installation includes a library document with useful Linear Algebra functions. The library is named **linalg** or **linalgCAS** and is installed in the designated library folder.

**Note:** Updating the handheld's operating system or reinstalling the computer software places all included libraries in the default folder. If you have edited an object in an included library or replaced an included library with your own document of the same name, updating or reinstalling will overwrite your changes. This could also happen after batteries are replaced or the handheld system is reset.

## **Restoring an Included Library**

If you inadvertently delete or overwrite an included library, you can restore it from the installation DVD.

1. Open the DVD, and navigate to the **libs** folder.
2. Identify the library file to restore, such as **linalg.tns** or **linalgCAS.tns** for the linear algebra library.
3. Copy the file.
  - Windows®: Copy the file to your designated library folder. The default location is **My Documents\TI-Nspire\MyLib**.

- Mac®: Copy the file to your designated library folder. The default location is **Documents/TI-Nspire/MyLib**.
  - Handheld: Connect the handheld to your computer, open the TI-Nspire™ software, and copy the library file to the handheld's **MyLib** folder.
4. Activate the new library objects.
- From the TI-Nspire™ Software **Tools** menu, click **Refresh Libraries**.
- Handheld: Press ctrl menu, and click **Refresh Libraries**.



# Using the TI-SmartView™ Emulator

With three layout options to choose from, teachers will find that the emulator facilitates classroom presentations. In the teacher software, layout options are:

- Handheld Only
- Keypad + SideScreen
- Handheld + SideScreen

In the student software, the TI-SmartView™ emulates the keypad, which along with the handheld view, gives students the ability to drive the software as if using a handheld.

## Opening the TI-SmartView™ Emulator

The TI-SmartView™ emulator is located in the Documents Workspace. To open the emulator view:

1. Open the Documents Workspace.
2. Click , which is located in the Documents Toolbox.

In the teacher software, the handheld is displayed with Handheld and SideScreen panels open in computer mode as shown in the following illustration. You can use the keypad on the emulated handheld, but the document won't appear on the emulated handheld screen until you switch to Handheld mode.

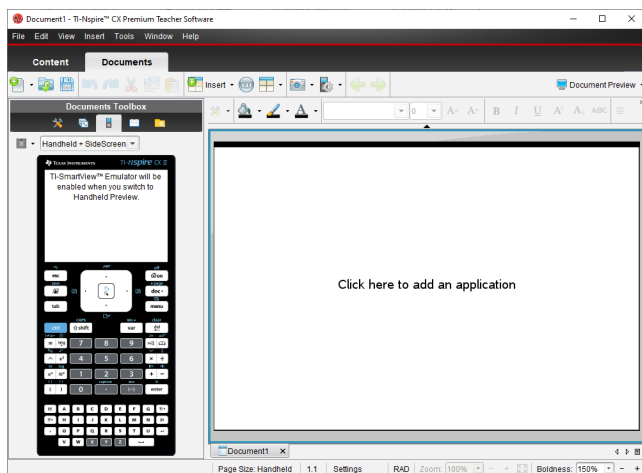

In the student software, the TI-Nspire™ CX II keypad is displayed with the side screen open in computer mode. You can use the keypad on the emulated handheld to work with the document in the side screen in either computer mode or handheld mode.

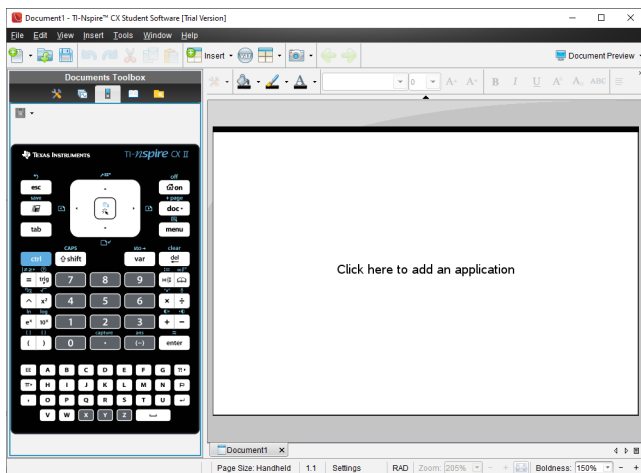

3. Click **View > Handheld**.

—or—

Click  in the status bar to switch to handheld mode.

## Choosing Display Options

In the teacher software, use this option to choose how to display the emulator in the software window.

1. In the emulator panel, click .

—or—

Click **File > Settings > TI-SmartView™ Options**.

2. Select one of the following options:

- **Handheld Only.** Displays the emulated handheld and hides the workspace and other panels.

**Note:** To keep the Handheld Only display in front of other application windows, click **Always in Front** at the top right of the TI-SmartView™ panel.

- **Keypad + SideScreen.** Opens a larger view of the keypad along with the side screen.
- **Handheld + SideScreen.** Opens the entire emulated handheld along with the side screen.

## Changing the Faceplate

To select a faceplate option:

1. In the emulator panel, click  to open the menu.

—or—

Click **File > Settings > TI-SmartView™ Options**.

2. Select one of the following options:

- Dark
- Light
- Outline

### Changing the Width of the TI-SmartView™ Panel

To change the width of the TI-SmartView™ emulator panel:

- ▶ Click the right edge of the panel and drag it until it is the width you want.

### Changing the Size of the Screen in the Workspace

When in handheld mode, use the Scale to change the size of the screen.

- ▶ Drag the slider to the appropriate scale percentage. The scale slider is located on the far right side of the status bar, at the bottom of the TI-Nspire™ window. Scale percentages range from 100% to 200%. The default scale is 150%.



**Note:** If computer mode is selected, you cannot change the size of the workspace.

### Working with the Emulated Handheld

To input data and work with files on the emulator, you can use the computer keyboard, TI-SmartView™ keypad, TI-Nspire™ menus and icons, or any combination of these.

**Note:** Within one command, you cannot use a combination of both the keypad and the keyboard. For example, you cannot press **Ctrl** on the keyboard and click **menu** on the emulator to open a context menu.

For the most part, you can perform any function in the TI-SmartView™ emulator that you can perform on the handheld. Keys and applications operate the same way.

**Note:** If you switch to Computer mode, you can still use most of the keys on the emulated handheld or keypad and all keystrokes are reflected in the workspace. However, some key combinations may only work in Handheld mode.

As you click keys on the emulator or press keys on the keyboard that activate keys on the emulator, those keys change color, making it easy for your audience to follow along. The last key selected stays highlighted.

In the teacher software, the emulator screen and the side screen are both interactive. You can click on icons and menu items on both screens. You can also right-click to display menus on both screens.

All handheld shortcuts and arrow functionality work from the computer keyboard. For example, to save a document, you can click **ctrl** **S** on the emulator keypad or you can press **Ctrl + S** on the computer keyboard. When using a Mac®, press **⌘ + S**.

## Using the Touchpad

You can operate the Touchpad on the TI-Nspire™ Touchpad keypad using either the touchpad on a laptop or by using the mouse to click the Touchpad. Areas of the Touchpad are highlighted as you click the arrow zones.

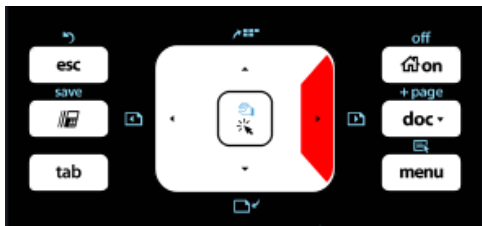

An arrow is highlighted when you press or tap it.

- Clicking the ◀, ▶, ▲, or ▼ keys on the Touchpad moves through menus one item at a time.
- Clicking and holding down an arrow on the Touchpad causes continual movement in the selected direction.
- Clicking and sliding the mouse across the Touchpad area enables you to move the mouse pointer.
- Clicking the middle of the Touchpad selects the highlighted menu option.

## Using Settings and Status

When working with the TI-SmartView™ emulator, you can change General Settings and Document Settings. For more information, see *Using the Documents Workspace*.

You can view all other settings, but you cannot change them in the TI-SmartView™ emulator. However, the ability to view these options provides teachers with an instructional tool when they need to show students how to set up a handheld.

To view settings and status:

1. Click to access the Home screen.
2. Click **Settings**.

Setting or Settings	Description
Language	You can open the languages menu and select a language, but you cannot save changes. To change the language, use the TI-Nspire™ menu <b>File &gt; Settings &gt; Change Language</b> option.
Handheld Setup	You can open the menus and select items to demonstrate which items to choose, but you cannot save any changes.

Setting or Settings	Description
Handheld Status	You can access the screen. The # symbol replaces any numeric values that would be displayed on the handheld.
About	You can open the About screen and view the software version. Other information that pertains only to the handheld hardware is marked as "Not Applicable."
Login	You can display the Login to Class screen and type in the User Name and Password fields. <b>Login</b> is not available.

## Changing TI-SmartView™ Options

You can change the emulator options, even when the emulator panel is closed.

1. In the teacher software, click **File > Settings > TI-SmartView™ Options**.

The TI-SmartView™ Options dialog box opens.

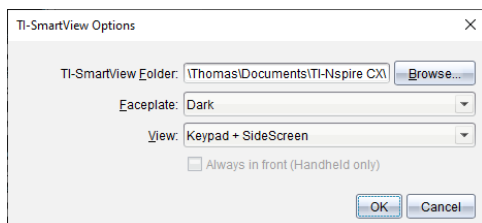

In the student software, click **File > Settings > Keypad Options**.

The Keypad Options dialog box opens.

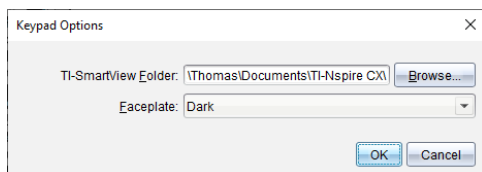

2. Click Browse to change the folder where documents are saved and accessed in the My Documents folder when using the emulator.

**Important:** If you change the TI-SmartView™ location, you must also copy or move the MyLib folder and paste it to the new location to see library objects.

The default location of MyLib is:

- Windows®: Documents\TI-Nspire\MyLib.
- Mac®: Documents/TI-Nspire/MyLib.

**Note:** Close and reopen the TI-Nspire™ application for the libraries to reflect the change.

3. Click ▼ to open the menu and select a faceplate.
4. In the teacher software, click ▼ to open the menu and select a view. If selecting Handheld Only, select **Always in Front** to keep this window on top of all other open applications.
5. Click **OK** to save the settings.

## ***Working with Documents***

You can open multiple documents in the workspace by selecting **File > Open Document** from the menu or using keyboard shortcuts. When you switch between these documents, the emulated handheld shows only the current document. You can insert pages and problems using either the TI-Nspire™ menus or icons, keyboard shortcuts, or TI-SmartView™ menus or shortcuts.

**Note:** You cannot work with PublishView™ documents using the TI-SmartView™ emulator. When you create or open a PublishView™ document, the document opens in Computer mode.

### **Opening a Document**

You can open a document by navigating to it on the emulator, the same way you open a document on the handheld, or you click **File > Open Document**.

When you open a document using the emulator, you can only open documents that are in the folder displayed on the emulator (usually the My Documents folder, unless you specified a different folder in your TI-SmartView™ settings). When you open a document using the menu path, you can browse to find any TI-Nspire™ document on your computer or network. If you open a document using the emulated handheld, it replaces the document that was previously open.

**Note:** If the number of characters in the document's file path name exceeds 256 characters, the document cannot be opened and an error message is displayed. To avoid this error, keep file and folder names short or move files up in the file path.

### **Saving a Document**

When you save a document using the **File > Save Document** menu or icon, keyboard shortcuts, keypad shortcuts, or emulator menus, the document is saved in the same location where the file was opened. To save the file in another location or with a different name, click **File > Save As**.

## ***Using Screen Capture***

To capture the current page, press **Ctrl + J** (Mac®: **⌘ + J**) on your keyboard or on the emulated handheld. The image is automatically placed in the Clipboard and in the TI-Nspire™ Screen Capture window. You can paste the image into another application without having to take additional steps. This feature is only available when the TI-SmartView™ panel is active and the workspace is in Handheld mode.

All other screen capture features work the same way they do in other areas of TI-Nspire™ software. For more information, see *Capturing Screens*.

## Using the Help Menu

Use the Help menu to find useful information to help you use the software more productively. You can:

- Open the PDF help file (press **F1** or click **Help**).
- Open the web-based help file (press **F2** or click **Online Help**).
- Activate your software license.
- Register your TI product.
- Explore TI resources such as Activities Exchange, where you can find lessons, quizzes, and other instructive activities shared by educators.
- Explore online troubleshooting.
- Check for updates to the software or updates to operating systems for TI-Nspire™ handhelds and the TI-Nspire™ Lab Cradle.
- Check to see which version of the software you are using.

### **Activating Your Software License**

1. Ensure that your computer is connected to the Internet.
2. From the **Help** menu, select **Activate** to open the Texas Instruments Activation Wizard.
3. Click **Activate your License**, and then click **Next**.

The Complete Software Activation dialog box opens.

Texas Instruments Activation Wizard

**Complete Software Activation**

To receive your activation information, TI-Nspire™CAS Teacher Software updates and promotions, complete the following.

First Last

Name

Email

Region

Inform me about TI-Nspire™CAS Teacher Software updates, support and promotions.\*

[\\*TI Privacy Policy](#)

<Back Next> Cancel

4. Complete the name and email fields, and then select the region where you live if different from the default entry. If you want to receive emails from TI about updates, support, and promotions, ensure the check box is selected.
5. Click **Next**.

The Activate your software dialog box opens.



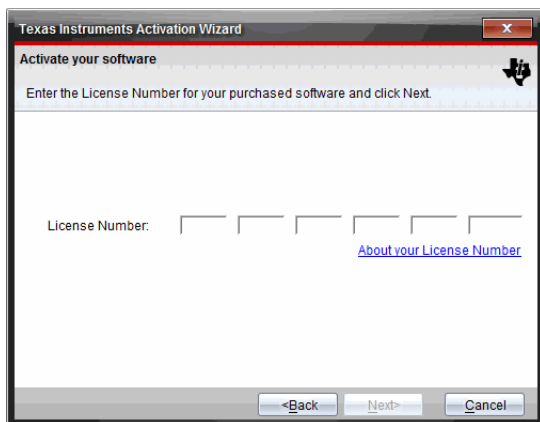

6. Type the license number.
7. Click **Next**.

The License Agreement dialog box opens.

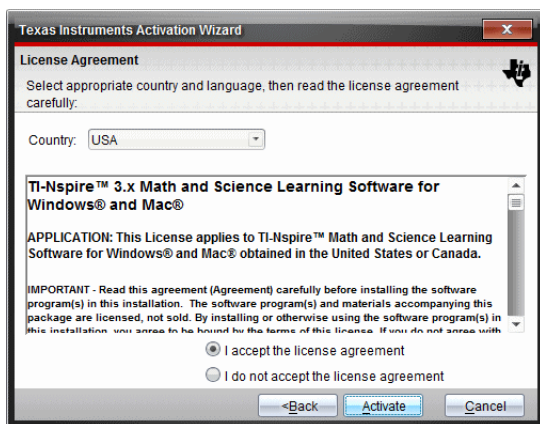

8. In the Country field, select your country from the drop-down list if it is different from the default entry.
9. Review the license agreement, and then select to accept the agreement.
10. Click **Activate**. The license number is validated against the TI database to ensure it is valid.

If the license number is valid, the Successful Activation dialog box opens. If the license number is not valid, check to make sure the numbers are entered correctly. If the problem persists, contact TI Support.

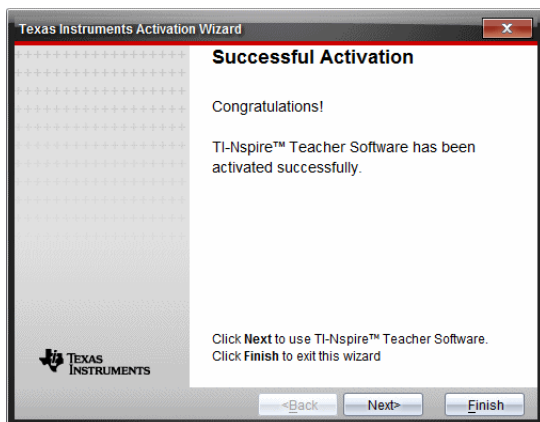

11. Click **Next** to continue, or select **Finish** to complete the installation with default settings.
12. When prompted, click **OK** to accept the default location for your TI-Nspire™ folder. If needed, navigate to the location on your computer where you want to store your TI-Nspire™ documents and files.
13. Select whether or not to replace any documents that have the same name.

The software launches and the **Welcome Screen** opens.

### ***Registering Your Product***

1. Ensure that your computer is connected to the Internet.
2. From the **Help** menu, select **Register** to access the TI Product Registration site.
3. Follow the instructions on the website.

### ***Downloading the Latest Guidebook***

1. Ensure that your computer is connected to the Internet.
2. From the **Help** menu, select **Download latest Guidebook**.

The Education Technology website opens with the Guidebooks tab active.

3. Click the title of the Guidebook that you want to download.

A PDF version of the Guidebook opens on your desktop.

### ***Exploring TI Resources***

The Help menu also provides links to TI resources and websites.

- ▶ Select **Help > Visit education.ti.com** to access the Texas Instruments Education Technology website.

- ▶ Select **Help > Visit Activities Exchange** to access the Texas Instruments Activities Exchange, site, a forum where you can browse by subject to find ready-to-use math and science learning activities appropriate for middle grades through college.

**Note:** Activities available for download may vary depending on your geographical region.

- ▶ Select **Help > Explore Online Troubleshooting** to access the TI Knowledge Base where you can find general information, troubleshooting help, product usage tips, and information specific to TI products.

## ***Updating the TI-Nspire™ Software***

### **Update the Software**

1. Ensure that your computer is connected to the Internet.
2. Close any open documents.
3. From the **Help** menu, select **Check for Upgrades and Notifications**.
  - If your software is current, a confirmation message appears.
  - If your software is not current, you are prompted to update.
4. Click **Update** to download and install the update, or click **Close** to cancel.

A progress indicator shows the download progress. If you receive a connection error, check your Internet connection and try again.

**Note for users updating TI-Nspire™ Navigator™ Teacher Software:** Your portfolio and class records reside on your computer as a database. Because the new software might have features that are not supported in the old database structure, the old data might need to be converted. When conversion is necessary, a Database Update tool helps you make a backup of the old database. The tool appears during the first startup of the updated software.

### **Manage Automatic Checking**

Automatic checking uses the Internet to check for upgrades each time you open the TI-Nspire™ software. If your system is not up-to-date, you receive a notification. You can turn automatic checking on or off.

1. From the **Help** menu, select **Check for Upgrades and Notifications**.
2. Check or clear the **Automatically check for updates** check box.
3. Click **Close**.

## ***Updating the OS on a Connected Handheld***

**Note:** To avoid losing unsaved data, close all documents on the handheld before updating its operating system.

1. Ensure that your computer is connected to the Internet.
2. In the Documents Toolbox, click the Content Explorer tab  to show connected handhelds.
3. Select the handheld that you are updating.

4. From the **Help** menu, select **Check for OS Updates**.

- If the operating system is current, a confirmation message appears.

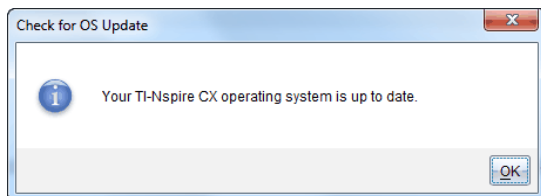

- If the operating system is not current, the TI-Nspire™ software prompts you to install the latest OS now. If the updated OS file is not already available on your computer, you can choose a location for it.

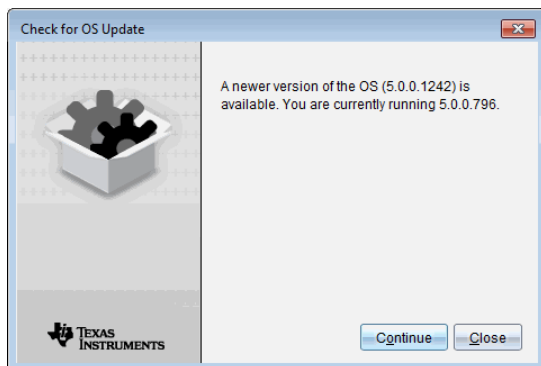

5. Click **Continue** and follow the prompts to install the OS on the handheld, or click **Close** to cancel.

When the update is complete, the handheld restarts automatically.

## ***Viewing Software Version and Legal Information***

1. From the Help menu, select **About TI-Nspire™ <Product Name>Software**.

**Note:** You do not need an Internet connection to open this screen.

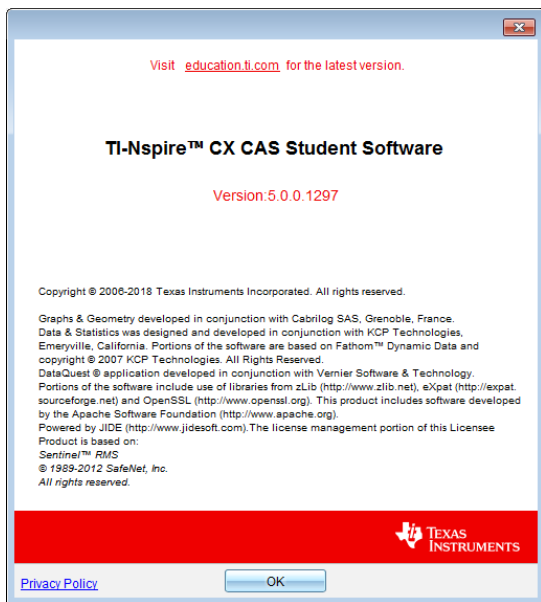

2. Click **OK** to close the window.

## ***Helping Improve the Product***

This product includes a feature that can help TI improve the product by automatically collecting anonymous information about product usage and reliability.

**Note:** Depending on how your software was installed, you might see a product improvement screen the first time you start the software. You also can access the feature manually.

1. From the **Help** menu, select **Product Improvements**.
2. Read the information on the screen, and click one of the buttons:
  - To allow information to be collected, click **Yes, I want to help**.
  - To prevent collection, click **No thanks**.

# Using Test Mode

The guidelines for many international, national, and state assessments allow or require students to use TI-Nspire™ Student Software when taking an exam. Test Mode enables you to quickly prepare the software for exams where use of applications, programs, and other files is restricted.

Test Mode can be configured by using either the **Choose Test Mode Restrictions** or **Enter Test Code** option. When the software is in Test Mode, students cannot access pre-existing folders, documents, or Scratchpad data. After the exam, these documents and features can be easily restored for classroom use.

The Test Mode feature is available on **Windows® computers only** at this time in the following versions:

- TI-Nspire™ CX Student Software version 5.3 or higher
- TI-Nspire™ CX CAS Student Software version 5.3 or higher

**Note:** To find out if your state allows TI-Nspire™ technology, see the State/Province Information website at [education.ti.com/go/testprep](http://education.ti.com/go/testprep).

## Entering Test Mode by Choosing Restrictions

**Note:** This applies to TI-Nspire™ CX and TI-Nspire™ CX CAS software except where noted. If you already have a test code, you can use the [Enter Test Code method](#).

1. Select **File > Test Mode > Choose Test Mode Restrictions**.

This will open the Test Mode Configuration dialog box.

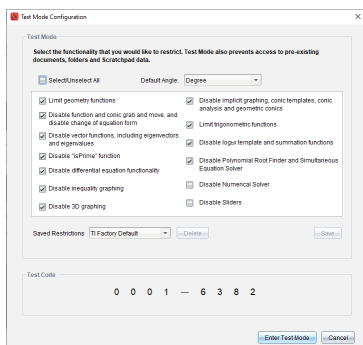

2. On the **Default angle** list, select the angle unit you wish to use. Available units are Degree and Radian.
3. Select the **CAS Mode** you wish to use. (TI-Nspire™ CX CAS Student Software only)
  - **On** enables CAS functions and symbol manipulation.
  - **Exact Arithmetic** enables exact results in terms of stacked fractions,  $\pi$ , and radicals  $\sqrt{\quad}$ .
  - **Off** disables CAS and exact results.

4. Select the **Exact Arithmetic** mode you wish to use. (TI-Nspire™ CX Student Software only with the TI-Nspire™ CX II-T handheld type selected)
  - **On** enables exact results in terms of stacked fractions,  $\pi$ , and radicals  $\sqrt{\quad}$ .
  - **Off** disables exact results.
5. Click the check box for each restriction to select or deselect it.

Click the **Select / Unselect All** box to quickly select or clear all restrictions.

In the Test Mode Code section, the code will automatically update based on your selections.

**Note:** For a detailed list of restrictions, refer to [Understanding Test Mode Restrictions](#).

6. (Optional) To save the current settings as a named configuration:
  - a) Click **Save**.
  - b) Type a **Name** into the **Save Configuration** dialog box.
  - c) Click **Save**.
7. Click **Enter Test Mode**.
  - If there are any open documents or screenshots, you will be prompted to save them.
  - The software window will maximize to the full size of your display and open a new document.
  - Pre-existing clipboard and TI-Nspire™ Scratchpad data is deleted.
  - A green title bar indicates that the software is in Test Mode. It displays the Configuration Name (if any), Test Code, the CAS or Exact Arithmetic mode status (when appropriate), time elapsed while in the test session, the information icon, and the Exit button.

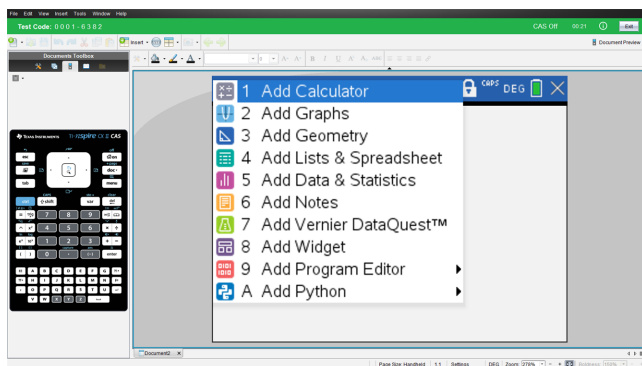

## Entering Test Mode with a Test Code

**Note:** This applies to TI-Nspire™ CX and TI-Nspire™ CX CAS software except where noted. If you do not know the test code, you can obtain it by using the [Choose Restrictions method](#).

1. Select **File > Test Mode > Enter Test Code**.

This will open the Test Mode Configuration dialog box.

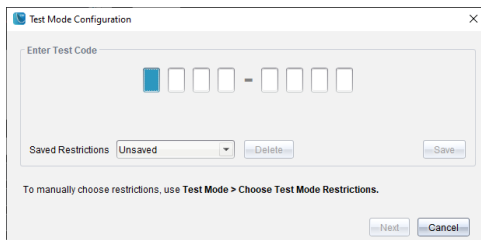

2. Enter your eight-digit test code.

If the code is valid, a green checkmark will display. The following example uses the TI Factory Default Code 0001-6382.

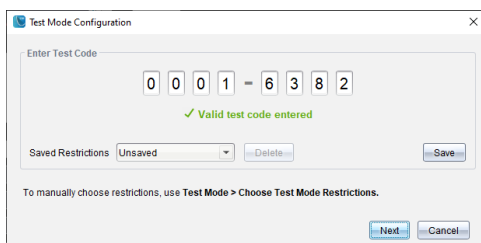

When the code is validated, it is stored and will be displayed when the **Enter Test code** dialog is invoked again.

The same test codes are used for both TI-Nspire™ Student Software and TI-Nspire™ CAS Student Software. The CAS and Exact Arithmetic Mode settings are ignored when appropriate.

3. Click **Next**.

The Summary screen displays so you can review the restrictions. Click **Back** if you need to enter a different code.



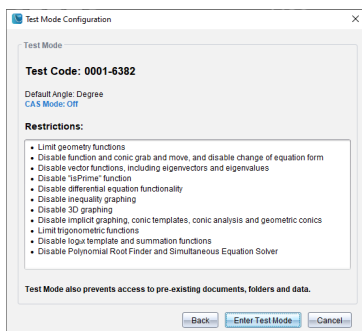

#### 4. Click **Enter Test Mode**.

- If there are any open documents or screenshots, you will be prompted to save them.
- The software window will maximize to the full size of your display and open a new document.
- Pre-existing clipboard and TI-Nspire™ Scratchpad data is deleted.
- A green title bar indicates that the software is in Test Mode. It displays the Configuration Name (if any), Test Code, the CAS or Exact Arithmetic mode status (when appropriate), time elapsed while in the test session, the information icon, and the Exit button.

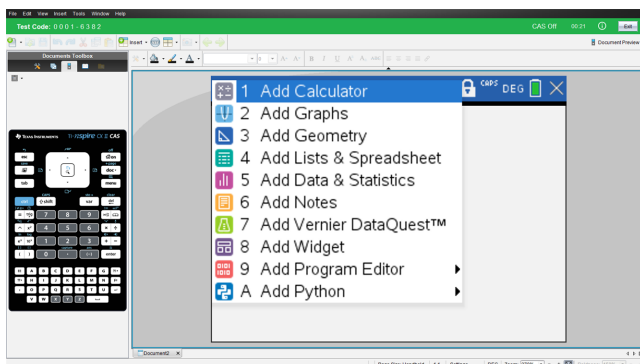

### Test Code Examples

#### ***TI Factory Default Restrictions***

- Default Angle = Degree
- CAS Mode = Off
- Numerical Solver enabled

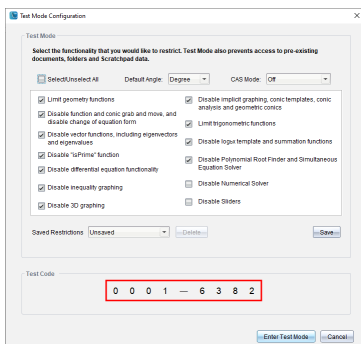

## Minimum Restrictions

- Default Angle = Degree
- CAS Mode = On
- All restrictions off

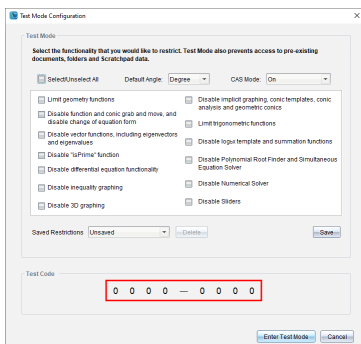

## Maximum Restrictions

- Default Angle = Degree
- CAS Mode = Off
- All restrictions on

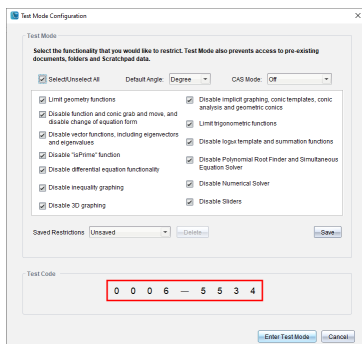

**Note:** Maximum restrictions Test Code will change if additional restrictions are added in the future.

## Reviewing Test Mode Restrictions

You can review the restrictions in effect when the software is in Test Mode. You cannot change the restrictions while in the testing session. You must exit Test Mode and re-enter it with new restrictions.

To review the current restrictions:

1. Click the information icon  in the Test Mode bar.

The Test Mode Information dialog opens which displays the following:

- Test Code
- Time in Test Mode
- Default Angle
- CAS Mode (TI-Nspire™ CX CAS Student Software only)
- Exact Arithmetic (TI-Nspire™ CX Student Software only with the TI-Nspire™ CX II-T handheld type selected)
- Restrictions
- Log of timestamps for various events

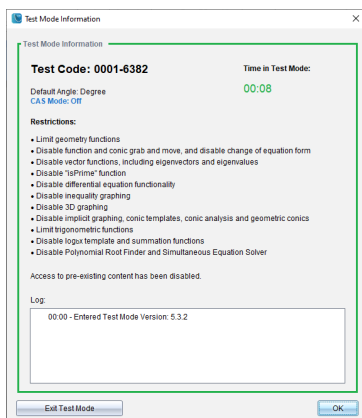

2. Click **OK** to return to the current test session, or click **Exit Test Mode** to end the session.

## ***Working with a Document in Test Mode***

While in Test Mode, you will only see documents you have created during the test session. You cannot open documents that were created before entering Test Mode.

### **Creating a New Document**

1. On the TI-Nspire™ **File** menu,
  - Select **New TI-Nspire™ Document - Handheld Page Size**.
  - or —
  - Select **New TI-Nspire™ Document - Computer Page Size**.

The new document opens in the Documents Workspace, and you are prompted to select an application.

2. Select an application to add a problem to the document.

The problem is added to the document.

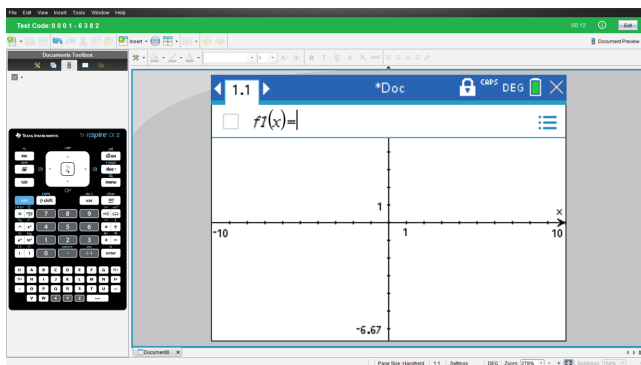

## Losing Software Focus in Test Mode

The TI-Nspire™ CX Student Software is designed to keep the user in Test Mode without access to other applications for the duration of the test. If the focus shifts away from the software, the title bar will turn red.

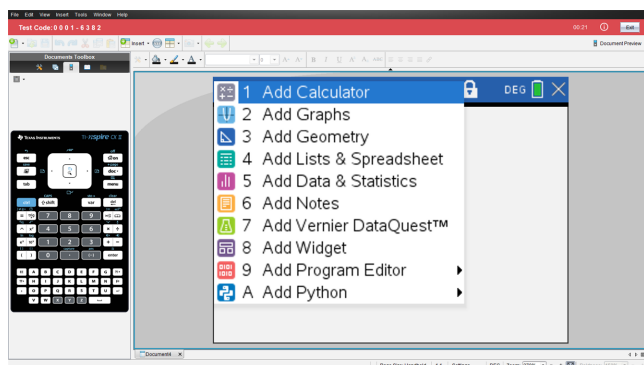

This activity is recorded as "Left Test Mode" on the Test Mode Summary dialog (below) and in the TestLog PDF file that is available after exiting the Test Mode.

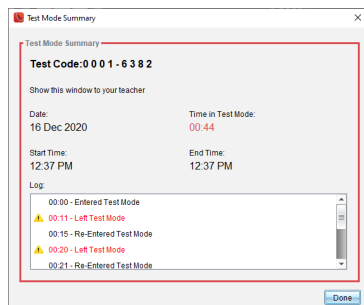

**Note:** To avoid any unintentional shifts away from Test Mode, it is recommended that other applications be closed or disabled beforehand, especially screen capture, accessibility, or other others that run in the background.

## Exiting Test Mode

When you exit Test Mode, any document created during the session is deleted and system settings are restored to their state before you entered Test Mode.

To exit Test Mode:

1. Click the **Exit** button on the Test Mode title bar.
2. On the **Exit Test Mode** prompt, click **Yes**.

The Test Mode Summary dialog opens which displays the following:

- Test Code
- Date
- Time in Test Mode
- Start Time and End Time
- Log of timestamps for various events

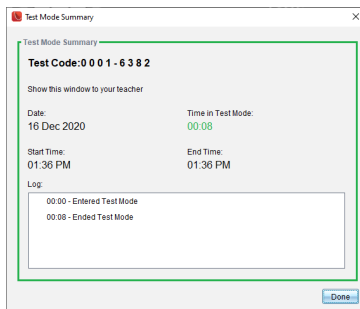

3. Click **Done**.

The Save as PDF dialog opens. This allows you to save the TestLog PDF file that contains the information from the Test Mode Summary dialog.

4. Select a location on your computer to save the TestLog and click **Save**.

The software is restored to a state as if it were just launched.

## Understanding Test Mode Restrictions

By default, all restrictions are selected when you enter Test Mode, with the exception of Numerical Solver.

- Selecting a restriction disables or limits its associated features during the Test Mode session.
- Clearing a restriction allows its associated features to be used during the session.

## Restricting Geometry Functions

When you choose to limit geometry functions, all items on the **Measurement**, **Construction**, and **Transformation** menus are disabled.

## Restricting Graphs Functions

On the Graphs menu, the following items are disabled:

- **Actions > Coordinates and Equations**
- **Geometry > Measurement, Construction, and Transformation**

## Disabling Function and Conic Grab and Move

- You cannot move any function or conic in Graphs, Geometry, or Scratchpad. For example, if you have graphed  $y=x^3$ , you can select the function but you cannot move or manipulate it by dragging.
- You cannot access the attribute that toggles the displayed form of a conic equation between Standard and Expanded.
- Disabling function and conic grab and move does not apply to lines and functions in Data & Statistics.
- Disabling function grab and move does not restrict sliders in the Graphs and Geometry applications.
- You can still grab the coordinate plane and move it around.

## Disabling Vector Functions

When vector functions are disabled, students cannot calculate the following functions:

- Unit vector [unitV{]}
- Cross product [crossP{]}
- Dot product [dotP{]}
- Eigenvector [eigVc{]}
- Eigenvalue [eigVI{]}

## Disabling the “isPrime” Function

The **isPrime**( function determines if a number is a prime number (a whole number greater than two that is evenly divisible only by itself and one). Disabling this function prevents students from selecting the **isPrime**{ command in the Catalog and from selecting **Test > IsPrime** in Math Operators. If a student manually enters the **isPrime**( function, submitting the expression results in an error message.

## Disabling Differential Equation Functionality

The Differential Equation graph type is disabled in the Graphs and Geometry applications. Users cannot manually type and graph a differential equation.

Related math functions `rk23()`, `euler()`, and `deSolve()` are also disabled.

## Disabling Inequality Graphing

When inequality graphing is disabled, students cannot graph inequalities with  $<$ ,  $>$ ,  $\leq$ , and  $\geq$  or grab and drag inequalities to a graph in the Graphs, Geometry, and Scratchpad applications.

## Disabling 3D Graphing

When this feature is disabled, students cannot use the 3D Graphing view.

## Disabling Implicit Graphing, Conic Templates, Conic Analysis, and Geometric Conics

When these features are disabled, students cannot graph equations in terms of  $x = ay + c$  or  $ax + by = c$ . Conic templates are not available, and students cannot analyze conics or graph the geometric conic of an ellipse, parabola, hyperbola, or conic by five points.

## Disabling Trigonometric Functions

Disabling trigonometric functions prevents students from using the following functions in calculations and graphing.

<code>csc</code>	<code>sec</code>	<code>cot</code>
<code>csc<sup>-1</sup></code> , <code>arccsc</code>	<code>sec<sup>-1</sup></code> , <code>arcsec</code>	<code>cot<sup>-1</sup></code> , <code>arccot</code>
<code>csch</code>	<code>sech</code>	<code>coth</code>
<code>csch<sup>-1</sup></code> , <code>arccsch</code>	<code>sech<sup>-1</sup></code> , <code>arcsech</code>	<code>coth<sup>-1</sup></code> , <code>arccoth</code>

- Attempting to evaluate any of these functions results in an error message.
- Students cannot select the `csc`, `sec`, `cot`, `csc-1`, `sec-1`, and `cot-1` functions by pressing  on the software.
- Students cannot select the disabled functions from the Catalog.

## Disabling the $\log_b x$ Template

Students cannot use the  $\log_b x$  (convert to logbase) and  $\log(a, b)$  commands and



templates, including  $\log_b x$  templates.

- When a student presses  $\lceil \log \rceil$  on the software, only calculations in  $\log_{10}$  format are accepted.
- If a student manually enters **log(a,b)** or **>logbase(** into an expression, attempting to evaluate the expression results in an error message.
- Students are allowed to enter **log(a)**, **log(a,10)**, and **log(a,10.)**.

### Disabling Summation Functions and Templates

Students are prevented from using summation functions and templates. The  $\sum$  and **sumSeq** functions are disabled.

### Disabling Polynomial Root Finder

The **polyRoots**(, **cPolyRoots**(, **solve**(, **simult**(, **zeros**(, and **cZeros**( functions are disabled. Attempting to evaluate any of these functions results in an error message.

**Note:** When the polynomial tools are disabled, students cannot use Find Roots of Polynomial, Real Roots of Polynomial, or Complex Roots of Polynomial.

### Disabling Simultaneous Equation Solver

The **linSolve**( and **simult**( functions are disabled in menus and in the Catalog. Attempting to evaluate either of these functions results in an error message.

### Disabling Numerical Solver

The **nSolve**( is disabled in menus and in the Catalog. Attempting to evaluate either of these functions results in an error message.

### Disabling Sliders

When this feature is disabled, students cannot insert or create sliders in the Graphs, Geometry, Data & Statistics, and Notes applications.

# Appendix A: Conversion Categories and Units

The following table lists categories and their respective units that are available in the Unit Conversion Assistant. When the units are pasted to the entry line, underscores ( \_ ) are added before the name of each unit to differentiate them from other variables. For example:

- `_cm ▶ _m`
- `_km/_hr ▶ _m/_s`
- `_°C ▶ _°F`

Category	Units
Length	Å (Angstrom)
	au (astronomical unit)
	cm (centimeter)
	dm (decimeter)
	fath (fathom)
	fm (fermi)
	ft (foot)
	in (inch)
	km (kilometer)
	ltyr (light-year)
	m (meter)
	µm (micron)
	mi (mile)
	mil (1/1000 inch)
	mm (millimeter)
	nm (nanometer)
	Nmi (nautical mile)
	pc (parsec)
rod (rod)	
yd (yard)	
Area	acre (acre)
	cm <sup>2</sup>
	dm <sup>2</sup>
	ft <sup>2</sup>
	ha (hectare)
	in <sup>2</sup>
	km <sup>2</sup>

Category	Units
	m <sup>2</sup>
	mi <sup>2</sup>
	mm <sup>2</sup>
	yd <sup>2</sup>
Volume	cm <sup>3</sup>
	cup (cup)
	dm <sup>3</sup>
	ft <sup>3</sup>
	floz (US fluid ounce)
	flozUK (British fluid ounce)
	gal (US gallon)
	galUK (British gallon)
	in <sup>3</sup>
	l (liter)
	m <sup>3</sup>
	ml (milliliter)
	pt (pint)
	qt (quart)
	tbsp (tablespoon)
	tsp (teaspoon)
	yd <sup>3</sup>
Time	day (day)
	hr (hour)
	min (minute)
	ms (millisecond)
	μs (microsecond)
	ns (nanosecond)
	s (second)
	week (week)
	yr (year)
Velocity	ft/min
	ft/s
	knot (knot)
	km/h

Category	Units
	km/min
	km/s
	m/s
	mi/h
	mi/min
	mi/s
Temperature	°C (Celsius)
	°F (Fahrenheit)
	K (kelvin)
	°R (Rankine)
Mass	amu (atomic mass unit)
	gm (gram)
	kg (kilogram)
	lb (pound)
	mg (milligram)
	mton (metric ton)
	oz (ounce)
	slug (slug)
	ton (ton)
	tonUK (long ton)
Force	dyne (dyne)
	kgf (kilogram force)
	lbf (pound force)
	N (newton)
	tonf (ton force)
Energy	BTU (British thermal unit)
	cal (calorie)
	erg (erg)
	eV (electron volt)
	ftlb (foot-pound)
	J (joule)
	kcal (kilocalorie)
	kJ (kilojoule)
	kgf*m
	kWh (kilowatt-hour)
	latm (liter-atmosphere)
Power	hp (horsepower)

<b>Category</b>	<b>Units</b>
	kW (kilowatt)
	PS (metric horsepower)
	W (watt)
Pressure	atm (atmosphere)
	bar (bar)
	inH <sub>2</sub> O (inches of water)
	inHg (inches of mercury)
	kPa (kilopascal)
	kgf/cm <sup>2</sup>
	lbf/in <sup>2</sup>
	mbar (millibar)
	mmH <sub>2</sub> O (millimeters of water)
	mmHg (millimeters of mercury)
	N/m <sup>2</sup>
	Pa (pascal)
	psi (pounds per square inch)
	torr (millimeters of mercury)

# General Information

## ***Online Help***

[education.ti.com/eguide](http://education.ti.com/eguide)

Select your country for more product information.

## ***Contact TI Support***

[education.ti.com/ti-cares](http://education.ti.com/ti-cares)

Select your country for technical and other support resources.

## ***Service and Warranty Information***

[education.ti.com/warranty](http://education.ti.com/warranty)

Select your country for information about the length and terms of the warranty or about product service.

Limited Warranty. This warranty does not affect your statutory rights.

Texas Instruments Incorporated

12500 TI Blvd.

Dallas, TX 75243

# Index

## 3

3D aspect ratio, changing .....	243
3D functions	
graphing .....	237
3D graph	
changing appearance .....	241
3D graphing .....	495
3D Graphing view .....	237, 239
3D graphs	
animating with sliders .....	245
editing expressions .....	240
plot colors .....	241
range settings .....	243
rotating .....	239
setting background colors .....	242
showing/hiding .....	242
shrinking/magnifying .....	242
3D parametric equations	
graphing .....	238
3D projection type .....	242

## A

activating software licenses .....	479
adding	
applications .....	43
applications (PublishView™ documents) .....	68
colors .....	38
copyrights to documents (.tns) .....	50
files to lesson bundles .....	98-99
images in Quick Poll .....	116
images to pages .....	116
pages .....	47
problems .....	47
shortcuts to lesson bundles ...	105
text (PublishView™ documents) .....	81
titles to graphs .....	446
alternative hypothesis .....	338
analysis options	
removing .....	438

analyzing data	
integral .....	435
model .....	438
tangent .....	435
angles	
measuring .....	220-221, 272
animating	
points .....	231, 285
animations	
changing points direction .....	231, 286
pausing .....	231, 286
resetting .....	231, 286
resuming .....	231, 286
appearance	
of 3D graph .....	241
application	
tools menu .....	2
applications	
adding .....	43
Calculator .....	124
Data & Statistics .....	341
deleting .....	47
Geometry .....	247
Graphs & Geometry .....	160
grouping .....	46
inserting images .....	116
Lists & Spreadsheet .....	291
Notes .....	388
swapping .....	44
approximate or exact results .....	304
arcs, drawing .....	205, 257
area, bounded .....	195
area, measuring .....	219, 271
arithmetic calculations .....	235, 289
aspect ratio, changing in 3D graphing	243
attributes	
changing for objects .....	216, 268
for variables .....	146
automatic	
sliders in Graphs application ...	154
axes	
adjusting .....	375
changing attributes in Graphing	
view .....	191

dilating .....	370	handheld current screens .....	108
moving (translation) .....	370	images in handheld mode .....	108
scaling .....	370	pages in active documents .....	108
setting values (Data & Statistics)	375	capturing images	
axis ranges		DragScreen .....	113
setting in graphs .....	447	caseplots (default) .....	342
<b>B</b>			
backup		Catalog	
of class data .....	482	converting measurement units	132
bar charts		inserting items from ..126, 129, 299, 320	
creating .....	359-360, 362	cell references	
borders (PublishView™ documents),		absolute and relative .....	298
hiding/showing .....	75	using in formulas .....	298
bounded area .....	195	cells	
box plots .....	348	body .....	294
breaking long calculations .....	396	copying in tables .....	299
<b>C</b>			
Calculate output option .....	320	deleting contents .....	299
calculating distributions (Lists &		entering text .....	294
Spreadsheet) .....	326	exact or approximate results ..	304
calculations		formulas .....	294
arithmetic .....	235, 289	inserting ranges in formulas ....	295
breaking .....	396	linking to variables .....	301
derivative settings .....	458	navigating in tables .....	297
types available .....	324	repeating formulas .....	300
using variables .....	152	selecting a block of .....	299
Calculator		selecting a range .....	295
menus .....	124	sharing table cells .....	300
Calculator application .....	124	changing	
calculated results variables ....	158	General Settings .....	22
Calculator history		Graphs & Geometry settings ...	24
copying .....	143-144	language .....	1, 3
deleting .....	145	changing screen size .....	474
reusing .....	144	charts	
viewing .....	143	bar .....	359
captions, viewing variable names ...	342	dot .....	358
capture page option .....	108	pie .....	361
Capture Selected Handheld option .	109	scatter .....	345
capturing		chemical equation boxes .....	401
active pages in documents ....	108	circle arcs, creating .....	205, 257
data (Lists & Spreadsheet) .....	315	circles, drawing .....	206, 258
		class data	
		backup .....	482
		closing documents (.tns) .....	36
		collected data	
		deleting .....	432



viewing details .....	433	context menu in Lists & Spreadsheet	302
collecting and managing data sets ..	430	converting	
color		.tns files to .tnsp files .....	95
setting grid color in Graphs ....	190	.tnsp files to .tns files .....	93
colors		measurement units .....	132
3D graph background .....	242	page size; page size, converting;	
applying to backgrounds .....	391	preview, setting	
changing .....	216, 241, 268,	document; setting	
	297-298, 381-	document preview	38
	382, 391	text to hyperlinks .....	89
changing for points .....	453	copying	
colors, adding .....	38	Calculator history .....	143-144
columns		cells from Excel® spreadsheets .	314
based on other columns .....	306	handheld images .....	108
copying .....	303	images .....	108
defining options .....	442	images in handheld mode ....	108
deleting .....	302	lesson bundles .....	104
deleting data from .....	304	screens .....	113
generating data in tables .....	305	table cells .....	299
inserting .....	129, 302	table data .....	312
linking to list variables .....	293	table rows or columns .....	303
moving .....	303	copyrights	
resizing .....	301	adding to documents (.tns) ....	50
selecting .....	301, 454	creating	
sharing table columns as lists ...	292	bar charts .....	359-360, 362
commands		histograms .....	352
cSimult( .....	496	lesson bundles .....	97, 104
inSolve( .....	496	lists from table columns .....	292
sumult( .....	496	matrices .....	128
comments, inserting in Notes .....	393	new documents .....	491
comparing		pie charts .....	361
data sets .....	431	plots .....	347
comparing collected data sets .....	430	probability plots .....	355
confidence intervals available .....	332	PublishView™ documents .....	52
conic analysis .....	495	scatter plots .....	356
conic by five points .....	211, 262	shapes with MathDraw .....	211, 263
conic templates .....	495	summary plots .....	311
conics, graphing .....	172	system of equations .....	131
constructions		user-defined units .....	133
locus .....	215, 267	variables .....	147-148, 150
Content Explorer .....	18	creating documents (.tns) .....	33
context menu		curve fit options .....	437
graphing from .....	400	curves, bounded area .....	195

customizing			
Graphs work area .....	190		
<b>D</b>			
data			
backup of class data .....	482		
capturing (Lists & Spreadsheet)	315		
capturing object data (Graphs & Geometry) .....	315		
copying to other applications ..	312		
deleting from columns .....	304		
displaying values .....	344, 347		
exact or approximate results ..	304		
generating columns of .....	305		
graphing table data .....	308		
raw and summary overview ...	346		
retrieving remote .....	428		
selecting ranges .....	451		
sorting in tables .....	304		
sorting plotted categories .....	367		
Data & Statistics			
getting started with .....	341		
settings .....	342		
data analysis			
interpolation .....	436		
data collections			
remote sensors .....	426		
scaling graphs .....	450		
setting sensor parameters .....	417		
thresholds .....	428		
data plots			
finding curve fit .....	437		
data sets			
comparing .....	431		
deleting collected .....	432		
renaming .....	432		
selecting for replays .....	457		
selecting to plot .....	449		
storing .....	430		
data sets, collecting and managing .	430		
defined functions, recalling .....	140		
defining			
functions .....	131, 137-138		
settings .....	1, 3		
units .....	133		
deleting			
applications .....	47		
Calculator history .....	145		
collected data sets .....	432		
contents of table cells .....	299		
data from columns .....	304		
documents (.tns) .....	36		
elements from lists .....	293		
hyperlinks (PublishView™ documents) .....	89		
images .....	118		
images (PublishView™ documents) .....	91		
lesson bundles .....	104-105		
linked variables .....	159		
pages .....	46, 48		
parts of expressions .....	141		
problems .....	46, 48		
PublishView™ objects .....	66		
table rows and columns .....	302		
derivative settings			
adjusting .....	458		
diagnostics, regression .....	342		
differential equation graphing .....	495		
differential equations, graphing .....	182		
dilating axes .....	370		
disabling functions			
"isPrime" .....	494		
3D graphing .....	495		
conic analysis .....	495		
conic templates .....	495		
differential equation graphing ..	495		
function and conic grab and move .....	494		
geometry functions .....	494		
implicit graphing .....	495		
inequality graphing .....	495		
logbx template .....	495		
numeric solver .....	496		
polynomial root finder .....	496		
simultaneous equation solver ..	496		
sliders .....	496		
summation functions and	496		

templates .....	
trigonometric functions .....	495
vector functions .....	494
displaying	
data values .....	344, 347
Graph 1 .....	441
graphs .....	441
graphs in Page Layout view .....	442
grid in Graphs .....	190
TI-SmartView™ emulator in teacher software .....	473
two graphs simultaneously .....	441
variable values .....	148
distribution, calculating .....	326
documents .....	491
creating .tnsp files .....	52
printing .tnsp files .....	95
saving .tnsp files .....	56
documents (.tns)	
changing General Settings .....	22
closing .....	36
creating .....	33
deleting .....	36
opening .....	27, 34
opening with TI-SmartView™ emulator .....	477
printing .....	49
properties .....	50
protecting .....	51
read-only .....	51
saving .....	27, 35-36
saving in emulator .....	477
switching between .....	40
viewing .....	40
documents workspace .....	2
domain restrictions .....	167
dot charts .....	358
DragScreen feature .....	108, 113
drawing	
arcs .....	205, 257
rectangles .....	207, 259
statistics plots .....	386
triangles .....	207, 258
drawing geometric shapes .....	206, 257

drawing shapes	
ellipse .....	209, 260

## E

editing .....	186
expressions .....	141
functions .....	186
table settings .....	340
values in lists .....	293
elements, deleting from lists .....	293
ellipse	
as geometric shape .....	209, 260
emailing lesson bundles .....	106
emulator, See TI-SmartView™	
emulator .....	16
enabling	
Test Mode .....	485, 487
entry line	
multiple statements .....	132
equations	
differential .....	183
graphing .....	171
graphing parametric .....	178
graphing polar .....	178
Lotka-Volterra .....	182
of geometric objects .....	234
ordinary differential equations (ODE) .....	182
errors	
showing (Notes) .....	397
estimating	
values between data points .....	436
evaluating expressions .....	127
exact input, for window settings .....	188
exact or approximate results .....	304
Excel® spreadsheets, copying from .....	314
exiting	
Test Mode .....	493
expanding view details area .....	433
experiments	
basic steps .....	411
Exploring the Documents workspace .....	2
expressions .....	186
changing functions in tables .....	339

copying from Calculator history	143-144	defining	131, 137-138
deleting parts of	141	displaying history	187, 240
editing	141, 240	displaying list of in tables	339
entering from templates	126-127	domain restrictions	167
entering in tables	294	editing	186
entering with wizards	129, 320	finance	142
evaluating	125, 396	graphing	163, 170, 376
selecting (Calculator)	141	hiding table of	186
selecting (Notes)	392	hiding/showing	193
		recalling definitions	140
		renaming	187
		rotating	165
		showing values in tables	339
		stretching	165
		supported distributions	328
		translating	165
		<b>G</b>	
<b>F</b>		generating	
files		columns of data	306
adding to lesson bundles	98-99, 103	geometric objects	
copying/pasting from lesson		equations of	234
bundles	102	geometric shapes	
deleting from lesson bundles	103	conic by five points	211, 262
image file types	116	hyperbola	210, 262
opening in lesson bundles	101-102	parabola	209-210, 261
pasting from lesson bundles	103	Geometry	
refreshing list in lesson bundles	103-104	hiding objects	284
renaming in lesson bundles	103	Geometry application	247
working with files on connected		Geometry application settings	161, 247
handhelds	26	geometry functions	494
finance functions	142	gestures, to create shapes	
Finance Solver	142	(MathDraw)	211, 263
finding		graph	
area under collected data	435	changing appearance	241
slope of collected data	435	graphing	
software version number	483	3D functions	237
folders		3D parametric equations	238
storing PublishView™ objects	67	3D view	237
footers in PublishView™ documents	75	conic sections	172
formatting		equations	171
results (Calculator)	125	from context menu	400
text (PublishView™ documents)	82	functions	163, 170, 376
formatting text	37		
formatting toolbar			
hiding	38		
showing	38		
frequency plots	310		
function and conic grab and move	494		
functions			
changing expressions in tables	339		

parametric equations	178	Help, accessing	479
path plot	164	helping improve the product	484
polar equations	178	hiding	
relations	175	3D graphs	242
scatter plots	179	functions in work areas	193
sequences	180	objects in Geometry	284
table data	308	table of functions	186
time plots	180	hiding format toolbar	38
web plots	180	histograms	
Graphing view		adjusting scale	352
changing axes attributes	191	creating	352
graphs		exploring data in bins	352
adding titles	446	modifying bins	354
displaying	441	scale formats	352
displaying Graph 1	441	history	
displaying in Page Layout view	442	relation	187, 240
displaying two simultaneously	441	history, See Calculator history	143
position versus time	460	hyperbola	
rescaling	370	as geometric shape	210, 262
scaling	450	hyperlinks (PublishView™	
setting axis range	447	documents)	
tracing all	197	converting text to	89
velocity versus time	460	editing	88
Graphs		linking to files	83
rescaling work area	188	linking to websites	86
Graphs & Geometry application	160		
Graphs & Geometry settings	24	<b>I</b>	
grid		images	
appearance in Graphs	190	deleting	118
displaying	190	file types	116
grouping applications	46	inserting	116, 392
guidebooks, downloading	481	inserting background	162, 249, 284
		moving	117
<b>H</b>		Quick Poll	116
handhelds		resizing	118
capturing current screens	108	saving	108
capturing selected handhelds	109	selecting	117
checking for OS updates	28	TI-Nspire™ applications	116
copying images	108	images (PublishView™ documents)	89, 91
installing OS update	29	implicit graphing	495
pasting images	108	importing	
working with files on connected	26	remote data	428
headers in PublishView™ documents	75	inequality graphing	495

inferential statistics	
calculating test results	
(Calculate) .....	320
drawing plots .....	386
graphing test results .....	320
input descriptions table .....	320
pooled option .....	338
inserting	
background images .....	162, 249, 284
cell ranges in formulas .....	295
chemical equations .....	392
comments in Notes .....	392
elements in lists (Lists & Spreadsheet) .....	293
hyperlinks (PublishView™ documents) .....	83
images .....	392
images (PublishView™ documents) .....	90
images in Quick Poll .....	116
images to pages .....	116
math expressions .....	392
PublishView™ objects .....	63
rows or columns in tables .....	302
rows or columns into matrices ..	129
shape symbols .....	392
text .....	383
text (PublishView™ documents)	81
installing	
software updates .....	482
installing a handheld OS update ....	29
intercept, changing .....	372
interfaces	
multi-channel sensors .....	412
single-channel sensors .....	412
intervals .....	420
isPrime function .....	494
<b>L</b>	
labeling	
point coordinates .....	234
language	
changing .....	1, 3
LED lights	
sensors .....	428
lesson bundles	
adding files .....	98-99, 103
adding shortcuts to .....	105
copying .....	105
copying/pasting .....	104-105
copying/pasting files .....	102
creating .....	97-98, 104
deleting .....	104-105
deleting files .....	103
emailing .....	106
opening .....	100-101, 103, 105
opening files .....	101-102
packaging .....	106
packaging pages .....	105
pasting .....	105
refreshing list of files .....	103-105
renaming .....	104-105
renaming files .....	103
sending .....	105, 107
libraries .....	467
Linear Algebra functions .....	470
refreshing .....	469
restoring .....	470
library objects	
creating shortcuts .....	470
private .....	468
public .....	468
using .....	469
Linear Algebra library functions ....	470
lines	
adding movable to plots .....	371
locking intercept at zero .....	372
rotating movable .....	371
tracing movable .....	373
lines (geometric)	
creating .....	203, 254
lines and points, creating .....	200, 252
linking	
columns to symbol table .....	442
table cells to variables .....	301
table columns to lists .....	293

to files .....	83	measuring objects .....	217, 269
to websites .....	86	menus	
values between applications ...	146	Calculator .....	124
variables .....	151-152	models, Pdf distribution .....	326
list math in Lists & Spreadsheet ....	295	motion match	
lists		options .....	460
deleting elements in tables .....	293	removing plots .....	460
inserting elements in tables .....	293	moving	
sharing table columns as .....	292	images .....	117
viewing and editing .....	293	images (PublishView™ documents) .....	91
Lists & Spreadsheet application ....	291	points (Data & Statistics) .....	367
locating software updates .....	482	PublishView™ objects .....	64
locking		rows and columns (Lists & Spreadsheet) .....	303
intercept of movable lines at zero .....	372	multiple-line functions .....	137-138
variables .....	157	multiple cells, selecting .....	299
locus construction .....	215, 267	multiple statements on entry line ..	132
logbx (convert to logbase) .....	496		
logbx template .....	495	<b>N</b>	
losing software focus .....	492	naming	
Lotka-Volterra equations .....	182	table columns .....	292
		variables (name conflicts) .....	301
<b>M</b>		naming columns .....	442
managing collected data sets .....	430	navigating in tables .....	296
math actions .....	397	new documents .....	491
math expression boxes .....	397, 402-403	normal probability, creating plots ..	355
math expressions, See expressions .	125	Notes	
math templates .....	126	adding shapes .....	393
MathDraw, creating shapes with		formatting text .....	390
gestures .....	211, 263	inserting comments .....	393
matrices		selecting text .....	390
creating .....	128	using colors .....	391
inserting rows or columns .....	129	numeric plots, splitting by categories	364
measurement units		numeric solver .....	496
changing (Vernier DataQuest™)	418		
measurements, converting units ...	132	<b>O</b>	
measuring		objects	
angles .....	220-221, 272	(PublishView™ documents) ....	61, 68
circumference or perimeter ...	218, 270	changing attributes .....	216, 268
distance between objects .....	218, 270	changing fill colors .....	216, 268
length .....	217, 269	dilating .....	225, 276
sides of objects .....	219, 270	duplicating .....	224, 275
slope of object .....	220, 271		





points	
animating .....	231, 285
changing colors .....	453
changing direction .....	231, 286
creating .....	200-201, 252-253
identifying intersections .....	202, 254
labeling coordinates .....	234
moving (Data & Statistics) .....	367
of interest .....	168
selecting (Data & Statistics) .....	367
setting markers .....	454
setting options .....	452
points and lines, creating .....	200, 252
polar equations	
graphing .....	178
polygons, drawing .....	208, 259
polynomial root finder .....	496
pooled variances .....	338
pre-defined measurement units .....	132
precision of results .....	125
predictive plots	
drawing and clearing .....	459
preview, printed document .....	50
print preview .....	50
printing	
PublishView™ documents .....	95
printing documents (.tns) .....	49
probability, creating plots .....	355
problems	
adding .....	47
deleting .....	46, 48
renaming .....	49
problems (PublishView™ documents)	
documents) .....	71, 73
product improvements .....	484
programs	
defining .....	137
Proof template .....	389
protecting documents (.tns) .....	51
PublishView™ documents	
applications .....	68, 71
converting .....	93, 95
creating .....	52
hyperlinks .....	82, 89
images .....	89, 91
objects .....	61, 67
printing .....	95
problems .....	71
problemsdeleting	
problems (PublishView™ documents)	
documents) 73	
saving .....	56
sheets .....	74, 80
text .....	80, 82
video files .....	92
<b>Q</b>	
Q & A template .....	389
questions	
responding .....	121
questions (students)	
checking answers .....	123
toolbar options .....	120
types of .....	120
Quick Graph, using .....	308
Quick Poll	
images .....	116
Quick Poll questions	
clearing answers .....	123
responding .....	121
types .....	122
<b>R</b>	
random numbers	
generating in tables .....	306
range of cells, inserting in formulas ..	295
raw data .....	346
raw data, adjusting histogram scale	
rays	
creating .....	204, 255
read-only documents (.tns) .....	51
reducing view details area .....	433
RefreshProbeVars .....	433
registering products .....	481
regression diagnostics .....	342
regression lines, showing .....	373

relations			
displaying history	187, 240		
graphing	175		
showing table of values	185		
remote data			
retrieving	428		
removing			
hyperlinks from text	89		
images	118		
linked variables	159		
renaming			
data sets	432		
functions	187		
lesson bundles	104-105		
problems (PublishView™ documents)	73		
renaming problems	49		
replays			
starting	457		
repositioning images	117		
rescaling			
graphs (dilation)	370		
graphs (translation)	370		
resizing			
images	118		
images (PublishView™ documents)	91		
PublishView™ objects	64		
table rows and columns	301		
restoring data	456		
restoring libraries	470		
results			
copying from Calculator history	143-144		
setting decimal approximation	125		
reviewing			
restrictions	490		
rotating objects	224, 276		
rows			
copying	303		
deleting	302		
inserting	129, 302		
moving	303		
resizing	301		
selecting	301		
			<b>S</b>
Save			
document as PDF	49		
saving			
captured images	108		
captured pages	111		
documents (.tns)	27		
documents (.tns) in emulator	477		
handheld screens	111		
images	108		
PublishView™ documents	56		
PublishView™ document as PDF	95		
saving documents (.tns)	35-36		
scaling graphs	450		
scaling Plane Geometry Analytic window	188		
scatter plots	356		
screen capture tool	108		
screen captures			
copying	113		
pasting	113		
scrolling in tables	296		
segments			
creating	203, 255		
selecting			
a block of table cells	299		
columns	454		
data ranges	451		
data sets for replays	457		
data sets to plot	449		
expressions in Calculator	141		
images	117		
table rows or columns	301		
templates	389		
text in Notes	390		
working folder (PublishView™ objects)	67		
selecting pages	45		
sensors			
calibrating	419		
changing measurement units	418		
connecting	416		
for computers	414		





displaying value .....	148	windows	
from calculator values .....	147	TI-Nspire™ Screen Capture ....	110
in calculations .....	152	wizards	
in Graphs & Geometry .....	148	entering expressions (Calculator)	129
in Lists & Spreadsheet .....	150	entering expressions (Lists & Spreadsheet) .....	320
linking .....	152	statistics .....	320
linking table columns to lists ...	293	work area	
linking to .....	301	customizing in Graphs and Geometry .....	190
linking to shared .....	151	work areas	
locking and unlocking .....	157	adding text to .....163, 190, 249, 285	
naming .....	153	working with documents .....	491
preventing naming conflicts ...	301	workspace	
removing linked variables .....	159	Documents .....	2
sharing table columns as lists ...	292		
types of .....	146		
unlinking .....	159	<b>X</b>	
variances, pooled .....	338	X-Y line plots .....	357
vector functions .....	494		
vectors		<b>Z</b>	
creating .....	205, 256	zooming .....	188
version number, locating .....	483	handheld preview .....	38
videos (PublishView™ documents)		in .....	452
inserting files .....	92	in/out .....	111
video console .....	93	out .....	452
view		PublishView™ documents ....	80
3D Graphing .....	237		
viewing			
captured screens .....	110		
documents (.tns) .....	40		
values in lists .....	293		
views			
3D Graphing .....	239		
Graph .....	411		
Page Layout .....	442		
Table .....	411		
<b>W</b>			
warnings, showing (Notes) .....	397		
websites, locating troubleshooting information .....	481		
window settings			
custom .....	188		