



**TI-*nspire***<sup>™</sup>

# Getting Started with the TI-Nspire<sup>™</sup> /TI-Nspire<sup>™</sup> CAS Handheld

This guidebook applies to TI-Nspire<sup>™</sup> software version 3.6. To obtain the latest version of the documentation, go to [education.ti.com/guides](http://education.ti.com/guides).

## Important Information

Except as otherwise expressly stated in the Licence that accompanies a program, Texas Instruments makes no warranty, either express or implied, including but not limited to any implied warranties of merchantability and fitness for a particular purpose, regarding any programs or book materials and makes such materials available solely on an "as-is" basis. In no event shall Texas Instruments be liable to anyone for special, collateral, incidental, or consequential damages in connection with or arising out of the purchase or use of these materials and the sole and exclusive liability of Texas Instruments, regardless of the form of action, shall not exceed the amount set forth in the licence for the program. Moreover, Texas Instruments shall not be liable for any claim of any kind whatsoever against the use of these materials by any other party.

Vernier DataQuest™ is a trademark of its respective owner.

© 2006 - 2013 Texas Instruments Incorporated

# Contents

Important Information .....	2
<b>Getting Started with the TI-Nspire™ Handheld .....</b>	<b>7</b>
About CAS .....	7
TI-Nspire™ Handheld Keys .....	7
Preparing the Handheld for Use .....	9
Turning On the TI-Nspire™ Handheld for the First Time .....	9
Using the TI-Nspire™ Touchpad .....	11
Using the Home Screen .....	12
Understanding the Scratchpad .....	15
The TI-Nspire™ Handheld Screen .....	15
Using Hints .....	16
<b>Using Keyboard Shortcuts .....</b>	<b>18</b>
<b>Using the Scratchpad .....</b>	<b>23</b>
Calculating with Scratchpad .....	24
Inserting Items from the Catalogue .....	25
Viewing the History .....	30
Editing Scratchpad Expressions .....	32
Graphing with the Scratchpad .....	32
Working with Variables in the Scratchpad .....	38
Saving the Scratchpad Contents .....	38
Clearing Scratchpad Contents .....	39
<b>Working with Documents on TI-Nspire™ Handhelds .....</b>	<b>41</b>
Opening a Document .....	41
Creating a New Document .....	42
Saving Documents .....	42
Working with Applications .....	44
Using the Application Menu .....	50
Context Menus .....	51
Working with Problems and Pages .....	52
Adding a Problem to a Document .....	52
Viewing and Reordering Pages in a Document .....	53
Copying, Pasting and Deleting Problems .....	57
Renaming a Problem .....	58

Adding a Page to a Problem .....	58
Moving Through Pages in a Document .....	59
Managing Documents .....	59
Closing a Document .....	64
Understanding the TI-Nspire™ Tools .....	64
<b>Working with Images .....</b>	<b>69</b>
Working with Images on a Handheld .....	69
<b>Working in a TI-Nspire™ Navigator™ Teacher Software Classroom .....</b>	<b>73</b>
Logging In .....	73
Pausing a Class Session .....	74
Understanding File Transfers .....	74
<b>Configuring Handhelds .....</b>	<b>77</b>
Installing the AAA Batteries .....	77
Replacing AAA Batteries .....	79
Inserting the TI-Nspire™ Rechargeable Battery .....	80
Checking Battery Status .....	83
Recharging the Handheld .....	83
Changing Handheld Settings .....	84
Changing the Preferred Language .....	85
Customising the Handheld Setup .....	86
Customising Document Settings .....	87
Customising Graphs & Geometry Settings .....	92
Viewing Handheld Status .....	94
Using Wireless Communication Hardware .....	96
<b>Connecting Handhelds and Transferring Files .....</b>	<b>99</b>
Connecting Handhelds .....	99
Transferring Files to and from Handhelds .....	101
Transferring Files Between Computers and Handhelds .....	103
Handling Errors Resulting from Sending Folders .....	105
<b>Memory and File Management .....</b>	<b>109</b>
Checking Available Memory .....	109
Freeing Memory .....	110
Resetting the Memory .....	113
<b>Updating the Handheld Operating System .....</b>	<b>115</b>

What You Need to Know .....	115
Finding Operating System Upgrades .....	116
Upgrading the Operating System .....	118
Upgrading the OS on Multiple Handhelds .....	122
OS Upgrade Messages .....	122
<b>Working in TI-84 Mode .....</b>	<b>125</b>
Changing the Keypad .....	125
TI-84 Plus Mode Cables .....	127
Capturing Screens in TI-84 Mode .....	128
Upgrading the TI-84 Plus OS .....	128
<b>Texas Instruments Support and Service .....</b>	<b>130</b>
Service and Warranty Information .....	130
Precautions for Rechargeable Batteries .....	130
<b>Index .....</b>	<b>131</b>



# Getting Started with the TI-Nspire™ Handheld

The TI-Nspire™ handheld and the TI-Nspire™ CAS handheld are the second generation handhelds in the TI-Nspire™ family of products. These handhelds provide touchpad navigation, dynamic graphing and interactive computer features.

The handheld and the TI-Nspire™ software share the same functionality, enabling you to transfer class assignments from the handheld to the computer or transfer documents to the handheld when you need to be mobile. Start assignments at school, and then finish the work at home to take advantage of the software's full-colour display and easy-to-use navigation. Use the software to download the latest software and handheld operating system updates as they become available to ensure you have the latest enhancements.

This guide covers both the TI-Nspire™ handheld and the TI-Nspire™ CAS handheld. While they operate identically in many ways, there are a few distinctions. If the TI-Nspire™ CAS handheld has additional functionality, it is pointed out and the CAS operation is described.

## ***About CAS***

With CAS, or the Computer Algebra System, you can:

- Perform both symbolic and numeric calculations.
- Factor and expand expressions and solve for common denominators.

TI-Nspire™ CAS technology makes it possible to recognise, simplify and calculate math expressions, preserving the symbols including variables and terms such as “e” and  $\pi$ .

This ability to enter and view equations and expressions on screen as they appear in textbooks is especially useful for step-by-step, arithmetic, algebraic and calculus calculations.

## ***TI-Nspire™ Handheld Keys***

Use the TI-Nspire™ Touchpad as you would a laptop touchpad. You can also press the outer edges to move right, left, up, and down.

**(esc)** Removes menus or dialogue boxes from the screen. Also stops a calculation in progress.

**(=|)** Opens the Scratchpad for performing quick calculations and graphing.

**(tab)** Moves to the next entry field.

**(ctrl)** Provides access to the function or character shown above each key. Also enables shortcuts in combination with other keys.

**(⇧shift)** Makes the next character typed upper-case.



**(ctrl on)** Turns on the handheld. If the handheld is on, this key displays the home screen.

**(doc >)** Opens the Document menu.

**(menu)** Displays the application or context menu.

**(del)** Deletes the previous character.

**(var)** Displays stored variables.

**(enter)** Evaluates an expression, executes an instruction, or selects a menu item.

Note: A **▶** symbol on a key indicates access to multiple options. To access an option, press **(?▶)** repeatedly or use the arrow keys on the Touchpad. Press **(enter)** or click to



select the option.

## Preparing the Handheld for Use

TI-Nspire™ handhelds are shipped with four alkaline AAA batteries and a standard A male to mini B male USB cable. Handhelds can also be powered using the TI-Nspire™ Rechargeable Battery or an approved wall charger, which are sold separately.

Before using the handheld, either install the AAA batteries or install and charge the TI-Nspire™ Rechargeable Battery (if purchased). You can also connect your handheld to an external power source if you have the wall charger.

**Note:** For more information about installing batteries, see *Configuring Handhelds*.

## Turning On the TI-Nspire™ Handheld for the First Time





1. Ensure that batteries have been installed or charged, or that the handheld is connected to a power source.
2. Press  to turn on the handheld.

A progress bar displays while the operating system loads, and then you are prompted to choose preferences for language and font size.

To turn the handheld off, press  . The settings and memory contents are retained.

**Note:** For more information about installing and charging batteries, see *Configuring Handhelds*.

## Using Automatic Power Down™

To prolong battery life, the Automatic Power Down™ (APD™) feature turns off the handheld after three minutes of inactivity. When this happens, press  to turn the handheld on and return to the last document or menu accessed. To change the default setting, press    to access the **Handheld Setup** screen where you can change the **Power Standby** setting.

**Note:** For more information about setting up the handheld, see *Configuring Handhelds*.

## Choosing a Language

After the OS is loaded, select a preferred language.

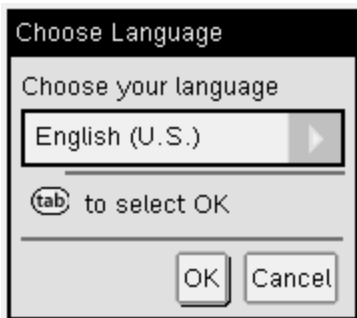

1. Press **▶** to open the drop-down list.
2. Press **▼** to scroll through the languages, and then press **↵** or **(enter)** to select a language.
3. Press **(tab)** to highlight the **OK** button, and then press **↵** or **(enter)** to save the language selection.

### Choosing a font size

Next, select a font size for the display.

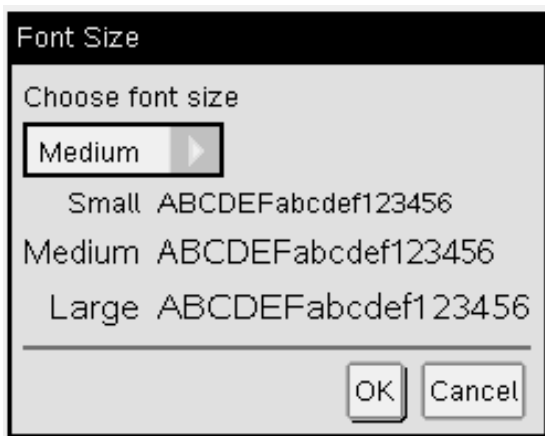

1. Press **▶** to open the drop-down list.
2. Press **▼** to highlight the font size, and then press **↵** or **(enter)** to select it.
3. Press **(tab)** to highlight the **OK** button, and then press **↵** or **(enter)** to save the selection and open the **Welcome!** screen.



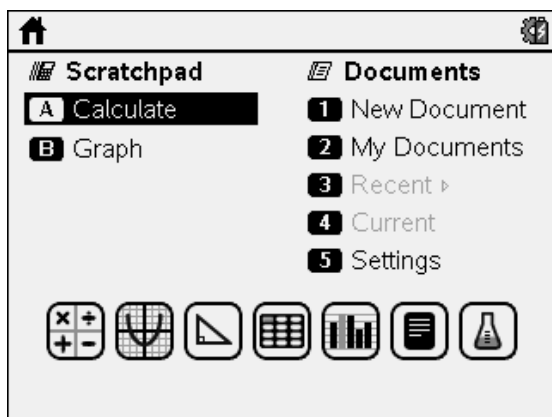

4. To continue, click  or press  to select **OK** and open the **Home** screen.





## Using the TI-Nspire™ Touchpad

Use the Touchpad to navigate or complete any task that can be completed using the arrow and Enter keys. Use the Touchpad to navigate in two ways:

- Use it like a computer touchpad by moving your fingertip in a sliding motion on the centre area of the Touchpad to activate and move the mouse pointer. Click or tap the centre of the Touchpad to select a menu option or complete an action.
- Press the arrow keys on the outside edge of the Touchpad to nudge the mouse pointer up, down, left or right, and then click  or press  to complete an action.

If you hold down an arrow key, the mouse pointer continues to move in that direction.

**Note:** If the mouse pointer is visible on a command or file, click or tap  in the centre of the Touchpad to select that command or file. If the command or file is highlighted, move the pointer over that item or press  to select it.

When working in an application, use the Touchpad to access more information about problems. For example, hovering over a Graphs & Geometry object displays information about variables used in that object and about tools that are available.

Some users prefer to customise their Touchpad settings; to speed up or slow down the pointer, or to enable tap to click. To change default settings for the Touchpad see *Configuring Handhelds*.





## Using the Home Screen



The **Home** screen opens when you power on your handheld for the first time. The **Home** screen provides a starting point for all activities performed on a handheld:

- Opening the Scratchpad for quick calculations and graphing
- Creating new documents
- Opening and managing existing documents
- Defining settings and viewing status
- Viewing hints for operating the handheld
- Accessing recent documents
- Returning to the current document



**Note:** To return to the **Home** screen from any other location, press .



## Selecting Options on the Home Screen

- By default, the cursor is not active. To activate the cursor, swipe the Touchpad with your fingertip.
- Use the Touchpad to click on any of the application icons or any of the Scratchpad or Documents menu options.
- Press the arrows on the Touchpad (, ,  or ) to move among the options on the **Home** screen.
- Move the mouse pointer over each application icon to view a brief description.



- Press  or  to select a highlighted option, or press the number or letter associated with the option.







## Adjusting the Contrast

To lighten the display, press and hold  and tap .

To darken the display, press and hold  and tap .

## Home Screen Options

Menu Option	Purpose
<b>Scratchpad</b> Use the Scratchpad menu options to open a Calculator or Graph application without affecting your document. While in Scratchpad, press  to toggle between Scratchpad applications: Calculate and Graph.	
Calculate	Opens the Scratchpad with a Calculator application active. From the Home screen, type <b>A</b> .
Graph	Opens the Scratchpad with a Graph application active. From the Home screen, type <b>B</b> .
<b>Documents</b> To select options for working with documents, press the associated number or use the Touchpad to select an icon then press  or  .	
New Document	Opens a new TI-Nspire™ document with available applications listed.
My Documents	Opens the file browser where you can open existing TI-Nspire™ documents or send files to others.
Recent	Lists the five most recently saved documents.
Current	Goes to the document that is currently open.
Settings	Check the status of the handheld and change settings.

Menu Option	Purpose
<p><b>Application icons</b></p> <p>To add a new page to the current document, select an application icon. If no document is open, a new document opens with the selected application on a new page.</p>	
<p><b>Calculator</b></p> 	<p>Adds a page to a document for entering and evaluating math expressions.</p>
<p><b>Graphs</b></p> 	<p>Adds a page for graphing and exploring functions.</p>
<p><b>Geometry</b></p> 	<p>Adds a page for creating and exploring geometric shapes.</p>
<p><b>Lists &amp; Spreadsheet</b></p> 	<p>Adds a page for working with data in tables.</p>
<p><b>Data &amp; Statistics</b></p> 	<p>Adds a page and provides tools used to visualize sets of data in different types of plots and provides tools for manipulating data sets to explore relationships between the sets of data.</p>
<p><b>Notes</b></p> 	<p>Provides text editing functions for adding text to TI-Nspire™ documents for use as notes or to share with other users.</p>
<p><b>Vernier DataQuest™</b></p> 	<p>Adds a page for collecting and analyzing data from sensors or probes.</p>

To learn more about applications and documents, see the *Working with Documents on the TI-Nspire™ handhelds*.

## Understanding the Scratchpad







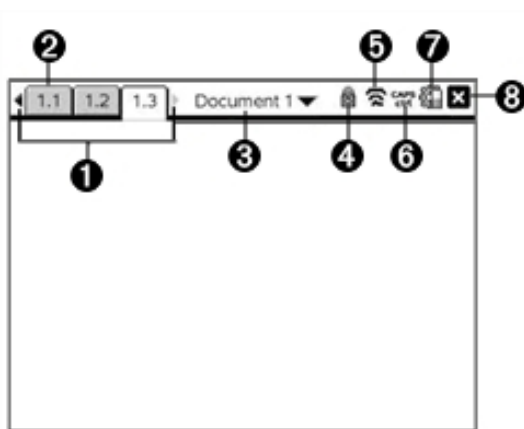

Use the Scratchpad to make quick calculations and graphs without affecting the current TI-Nspire™ document. For example, when you need a quick way to test a calculation before you add it to a document, you can open the Scratchpad application and perform the calculation. Then, you can either discard the calculation or add it to a document. For more information about the Scratchpad, please see *Using the Scratchpad*.

## The TI-Nspire™ Handheld Screen

The icons on the handheld screen provide information about the status of handheld operations and provide an easy way to access and change settings. This screen shows the icons, which are described below.







	Icon	Function
①	◀▶	<b>Page scrolling arrows</b> - Use the Touchpad and these arrows to scroll through the pages in a document.
②	1.1	<b>Page tabs</b> - Indicate the problem number followed by the page number. If problems are named, move the Touchpad

	Icon	Function
		pointer over the tab to view the page name.
3		<b>Document name</b> - Shows the current document name. Click here to access the Documents menu. An asterisk by the document name indicates changes were made since the document was last saved.
4		<b>Press to Test</b> - Indicates that the handheld is in Press-to-Test mode.
5		<b>Login status</b> - Shows whether the handheld is searching for an access point (blinking), found an access point (solid), not communicating, connected and ready to log in (a blinking arrow), or logged in and charged (a solid arrow). Click here to view Settings & Status.
6		 ,  , or  status
7		<b>Settings &amp; Status:</b> <ul style="list-style-type: none"> <li>• Hover the cursor over the icon to show the angle mode setting in effect for the active application and the level of the battery supply.</li> <li>• Click the icon to open the Settings menu.</li> </ul>
8		<b>Close document</b> - Click here to close the current document. If information is unsaved, save or discard when prompted.

## Using Hints

**Hints** are quick tips available throughout the software on the handheld. There are several easy ways to access Hints:























- Press  .
- Some dialogue boxes contain a question mark icon. Click this icon to open Hints for that task.
- ▶ To scroll through the Hints, use the Touchpad or arrow keys:
  - To page down, press  .





































- To page up, press **ctrl** **9**.
- To go to the end of the Hints file, press **ctrl** **1**.
- To go back to the beginning of the file, press **ctrl** **7**.



































# Using Keyboard Shortcuts

Use the following keyboard shortcuts to perform common functions. You can also perform all shortcuts performed by selecting options from menus.

<b>Getting Help</b>	
Open Hints	 
<b>Editing Text</b>	
Cut	 <b>X</b>
Copy	 <b>C</b>
Paste	 <b>V</b>
Undo	 <b>Z</b>  <b>esc</b>
Redo	 <b>Y</b>  <b>esc</b>
Toggle approximate and exact results	 <b>enter</b>
Change key to include appropriate accent	
<b>Inserting Characters and Symbols in a document</b>	
Display character/symbol palette	 
Underscore	 
Display maths template palette	
Backslash (\)	 
Manual data capture point	 
Clear	 

Caps Lock	<b>ctrl</b> <b>⇧shift</b>
Store	<b>ctrl</b> <b>var</b>
Square brackets	<b>ctrl</b> <b>(</b>
Curly brackets	<b>ctrl</b> <b>)</b>
Display Trig symbol palette	<b>trig</b>
Equals symbol	<b>=</b>
Display pi symbols palette ( $\pi$ , $/$ , $\theta$ and so on),	<b>(<math>\pi</math>)</b>
Display equality/inequality palette ( $>$ , $<$ , $\neq$ , $\leq$ , $\geq$ , and $ $ )	<b>ctrl</b> <b>=</b>
Display marks and letter symbols palette ( $?$ $!$ $\$$ $'$ $"$ $:$ $;$ $_$ $\backslash$ )	<b>(?!)</b>
Square root	<b>ctrl</b> <b>x<sup>2</sup></b>
log	<b>ctrl</b> <b>10<sup>x</sup></b>
ln	<b>ctrl</b> <b>e<sup>x</sup></b>
ans	<b>ctrl</b> <b>(-)</b>
<b>Managing Documents</b>	
Open document menu	<b>doc</b> <b>v</b>
Open document	<b>ctrl</b> <b>O</b>
Close document	<b>ctrl</b> <b>W</b>
Create new document	<b>ctrl</b> <b>N</b>
Insert new page	<b>ctrl</b> <b>I</b>

Select application	 
Save current document	   
<b>Navigation</b>	
Top of page	 
End of page	 
Page Up	 
Page Down	 
Up a level in the hierarchy	 
Down a level in the hierarchy	 
Context menu for selection	
Extends selection in direction of arrow	 Any arrow
<b>Navigating in Documents</b>	
Displays previous page	 
Displays next page	 
Displays Page Sorter	 
Exits Page Sorter	 
Switch between applications on a split page	 
Moves focus backward within page	 
<b>Wizards and Templates</b>	
Add a column to a matrix after the current column	 

Add a row to a matrix after the current row	
Integration template	 
Derivative template	 
Math template palette	 or  
Fraction template	 
<b>Modifying Display</b>	
Increase contrast	 
Decrease contrast	 
Power off	 
<b>Using Application-Specific Shortcuts</b>	
Select all in Notes or Programme Editor	 
Check syntax and store (in Programme Editor)	 
Insert Data Collection console	 
Find (in Programme Editor)	 
Hide/Show Entry Line (in Graph or Geometry) Go To (in Lists & Spreadsheet, Programme Editor)	 
Find and Replace (In Programme Editor)	 
Insert maths expression box (in Notes)	 
Open the Scratchpad	
Recalculate (in Lists & Spreadsheet)	 
Add Function Table (in Lists & Spreadsheet and Graphs & Geometry)	 

Group/ungroup

ctrl

4

/

ctrl

6

# Using the Scratchpad

The Scratchpad is a feature of the TI-Nspire™ handheld that lets you quickly:

- Evaluate maths expressions.
- Graph functions.

## Opening and Closing the Scratchpad

- ▶ From the Home screen, press  to open the Scratchpad.

The first time you open the Scratchpad, a blank page opens with the Calculator active.

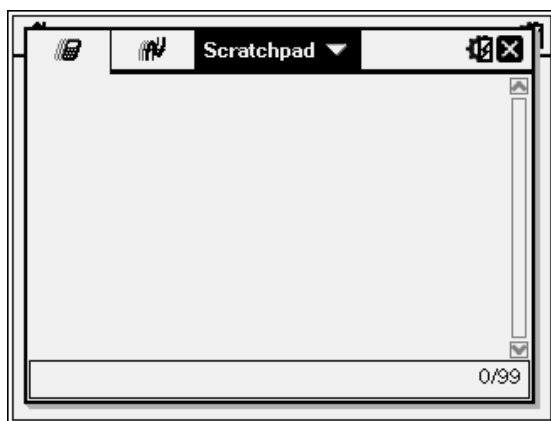

- ▶ Press  to alternate between the Calculate and Graph pages.

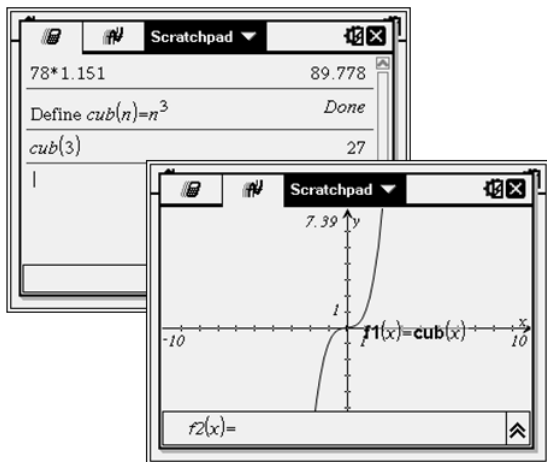

- ▶ Press **(menu)** to see the Scratchpad Calculate or Scratchpad Graph menu. These menus are subsets of the TI-Nspire™ menu for the Calculator and Graphs applications. For complete listings of those menus, see the documentation for those applications.
- ▶ Press **(esc)** to close the Scratchpad.

## Calculating with Scratchpad

From the Scratchpad Calculate page, enter a maths expression on the entry line, then press **(enter)** to evaluate the expression. Expressions are displayed in standard mathematical notation as you enter them.

Each evaluated expression and result becomes part of the Scratchpad history, displayed above the entry line.

### Entering Simple Maths Expressions

**Note:** To enter a negative number, press **(-)** and then type the number.

$$2^{8.43}$$

Suppose you want to evaluate  $2^{8.43}$

1. Select the entry line in the work area.
2. Type  $2 \wedge 8$  to begin the expression.

2.8



- Press  $\blacktriangleright$  to return the cursor to the baseline, and then complete the expression by typing:

$\otimes$  43  $\div$  12

---

$2^8 \cdot 43 / 12$

---

- Press  $\text{enter}$  to evaluate the expression.

The expression is displayed in standard mathematical notation, and the result is displayed on the right side of the page.

---

$2^8 \cdot 43$	$2752$
12	3

---

**Note:** You can force a decimal approximation in a result by pressing

$\text{ctrl}$   $\text{enter}$  instead of  $\text{enter}$ .

---

$2^8 \cdot 43$	917.333
12	

---

Pressing  $\text{ctrl}$   $\text{enter}$  forces the approximate result.

**Note:** Results formatting can also be adjusted in settings. For more information about customising settings, see *Configuring Handhelds*.

## ***Inserting Items from the Catalogue***

You can use the Catalogue to insert functions and commands, symbols and expression templates into the entry line.

- Press  $\text{ctrl}$   $\text{F9}$  to open the Catalogue. By default, the first tab is displayed, which lists all commands and functions in alphabetical order.



Catalog for a non-CAS handheld

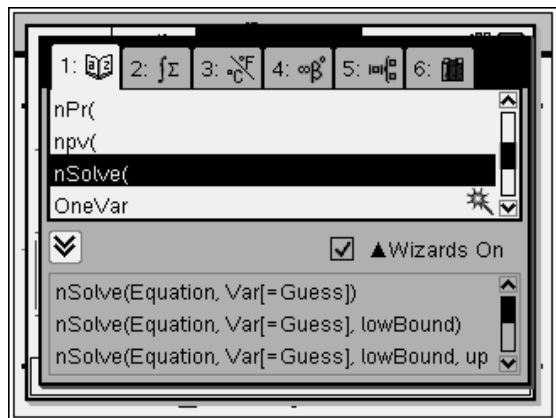

Catalog for a CAS handheld

2. If the function you are inserting is visible in the list, select it and press **(enter)** to insert it.
3. If the function is not visible:
  - a) Press a letter key to jump to the entries that begin with that letter.
  - b) Press **▼** or **▲** as necessary to highlight the item you are inserting.
  - c) Click a numbered tab to list functions by category: maths functions, symbols, maths templates, library objects and value for standard measurement units (CAS).
  - d) Press **(enter)** to insert the item into the entry line.

## Using an Expression Template

Templates help you enter matrices, piecewise functions, systems of equations, integrals, derivatives, products and other maths expressions.

$$\sum_{n=3}^7 (n)$$

For example, suppose you want to evaluate

1. Press  to open the Template palette.

2. Select  to insert the algebraic sum template.

The template appears on the entry line with small blocks representing elements that you can enter. A cursor appears next to one of the elements to show that you can type a value for that element.

---

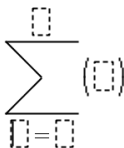

The image shows the algebraic sum template with empty boxes for the upper limit, the term, and the lower limit.

3. Use the arrow keys to move the cursor to each element's position, and type a value or expression for each element.

---

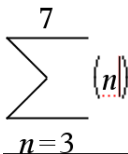

The image shows the algebraic sum template with the values 7, (n), and n=3 entered.

4. Press  to evaluate the expression.

---

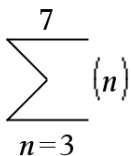

The image shows the algebraic sum template with the values 7, (n), and n=3 entered.

25

## Inserting Expressions Using a Wizard

You can use a wizard to simplify entering some expressions. The wizard contains labelled boxes to help you enter the arguments in the expression.

For example, suppose you want to fit a  $y=mx+b$  linear regression model to the following two lists:

{1,2,3,4,5}

{5,8,11,14,17}

1. Press  $\left[\text{2nd}\right]$   $\left[\text{1}\right]$  to open the Catalogue and show the alphabetic list of functions.
2. Click inside the list, and then press  $\left[\text{L}\right]$  to jump to the entries that begin with "L".
3. Press  $\blacktriangledown$  as necessary to highlight **LinRegMx**.
4. If the **Wizards On** option is not ticked, press  $\left[\text{tab}\right]$   $\left[\text{tab}\right]$  to highlight **Wizards On**.
5. Press  $\left[\text{enter}\right]$  to change the setting.
6. Press  $\left[\text{tab}\right]$   $\left[\text{tab}\right]$  to highlight **LinRegMx** again.

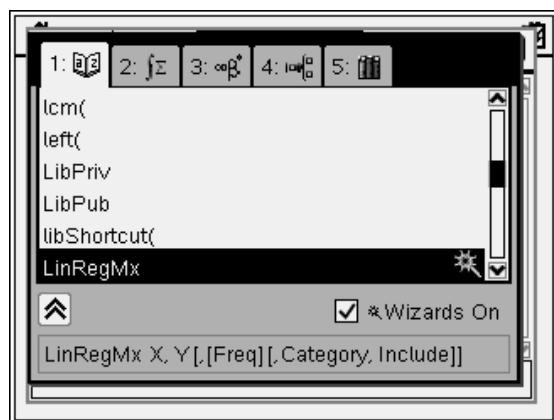

LinRegMx  
function in a non-  
CAS handheld

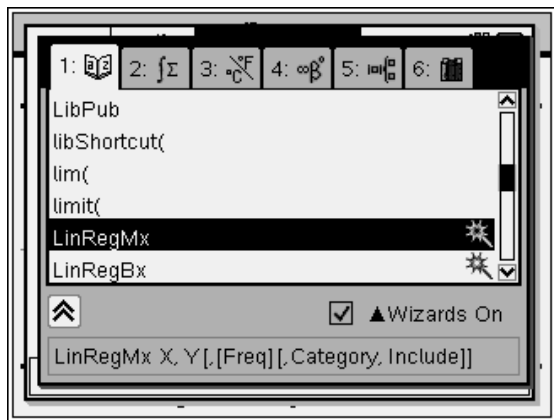

LinRegMx  
function in a CAS  
handheld

7. Press **(enter)**.

A wizard opens, giving you a labelled box to type each argument.

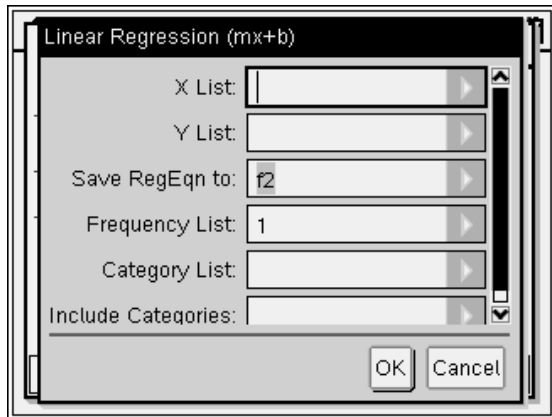

8. Type **{1, 2, 3, 4, 5}** as **X List**.
9. Press **(tab)** to move to the **Y List** field.
10. Type **{5, 8, 11, 14, 17}** as **Y List**.
11. If you want to store the regression equation in a specific variable, press **(tab)** and then replace **Save RegEqn To** with the name of the function variable (f1 through f99).
12. Click **OK** to close the wizard and insert the expression into the entry line.

The expression is inserted along with statements to copy the regression equation and display the variable *stat.results*, which will contain the results.

```
LinRegMx {1,2,3,4,5},{5,8,11,14,17},1: CopyVar stat.RegEqn,f1: stat.results
```

The Scratchpad then displays the *stat.results* variables.

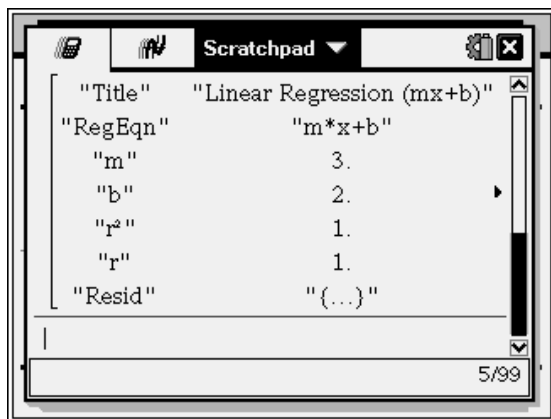

**Note:** You can copy values from the *stat.results* variables and paste them into the entry line.

## Viewing the History

Each evaluated expression and result becomes part of the Scratchpad history, displayed above the entry line.

- ▶ Press ▲ or ▼ to scroll through the history.

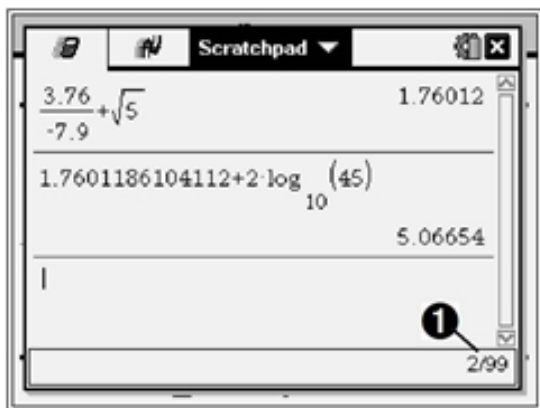

❶ Current entry/total entries

### Copying a History Item to the Entry Line

You can quickly copy an expression, sub-expression or result from the history into the entry line.

1. Press  $\blacktriangle$  or  $\blacktriangledown$  to move through the history and select the item that you want to copy.
2. Optionally, select part of the expression or result by using  $(\text{shift})$  in combination with the arrow keys.

---

approx	$\frac{2^8 \cdot 12}{42}$	73.1428571429
--------	---------------------------	---------------

---

3. Press  $(\text{enter})$  to copy the selection and insert it into the entry line.

---

$\sqrt{\frac{2^8 \cdot 12}{42}}$	$\frac{16 \cdot \sqrt{14}}{7}$
----------------------------------	--------------------------------

---

### Clearing the History

When you clear the history, all variables and functions defined in the history retain their current values. If you clear the history by mistake, use the undo feature.

- From the **Actions** menu, click **Clear History**.

–or–

Press **(menu)** **(1)** **(5)**.

All expressions and results are removed from the history.

## Editing Scratchpad Expressions

Although you cannot edit a Scratchpad Calculate expression in the history, you can copy all or part of an expression from the history and paste it into the entry line. You can then edit the entry line.

### Inserting Elements into the Entry Line

1. Press **(tab)**, **◀**, **▶**, **▲** or **▼** to position the cursor in the expression.  
The cursor moves to the closest valid position in the direction that you press.
2. Type the elements or insert them from the Catalogue.

### Selecting Part of an Expression

You can delete, cut or copy a selected part of an expression.

1. Press **◀**, **▶**, **▲**, or **▼** to move the cursor to a starting point in the expression.
2. Press and hold **(⇧shift)** and press **◀**, **▶**, **▲** or **▼** to select.
  - To delete the selection, press **(del)**.
  - To cut the selection to the Clipboard, press **(ctrl)** **(X)**.
  - To copy the selection to the Clipboard, press **(ctrl)** **(C)**.
  - To paste the selection to a new entry line in Scratchpad, press **(ctrl)** **(V)**.

## Graphing with the Scratchpad

1. Press **(=)** to open the Scratchpad Graph page if it's not already open.  
By default, the entry line is displayed. The entry line displays the required format for typing a relation. The default graph type is Function, so the form  $f1(x)=$  is displayed.  
If the entry line is not shown, press **Ctrl + G** or press **(menu)** **(2)** **(3)** to display the entry line and type an expression to graph.
2. Press **(menu)** **>** **Graph Entry/Edit** and select a graph type.  
For example:



- To graph an equation for a circle, press **(menu)** > **Graph Entry/Edit** > **Equation** > **Circle** >  $(x-h)^2 + (y-k)^2 = r^2$  or press **(menu)** **(3)** **(2)** **(3)** **(1)**. Fill in the equation and press **(enter)** to draw the circle.
- To graph a function, press **(menu)** > **Graph Entry/Edit** > **Function** or press **(menu)** **(3)** **(1)**.

The entry line changes to display the expression format for the specified graph type. You can specify multiple relations of each graph type.

- Type an expression and any other parameters required for the graph type.

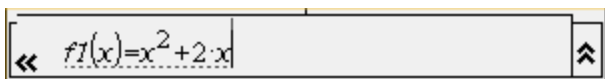

- Press **(enter)** to graph the relation, or press ▼ to add another relation. If necessary, use press **(menu)** **(4)** to choose a tool on the **Window/Zoom** menu and adjust the viewing area.

When you graph the relation, the entry line disappears to show an uncluttered view of the graph. If you select or trace a plot, the relation that defines the plot is displayed on the entry line. You can modify a plot by defining a relation or by selecting and changing the graph.

As you graph multiple plots, the defining relation is displayed for each. You can define and graph a maximum of 99 relations of each type.

- Use the **(menu)** key to explore and analyse the relation to:
  - Trace the relation.
  - Find points of interest.
  - Assign a variable in the expression to a slider.

## Viewing the Table

- To display a table of values corresponding to the current plots, press **(menu)** > **Table** > **Split-screen Table** (**(menu)** **(7)** **(1)**).

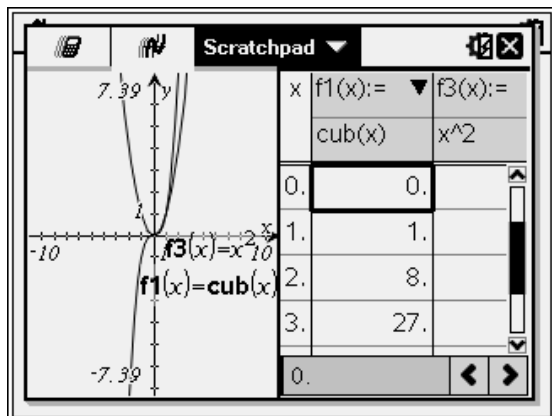

- ▶ To hide the table, click the graph side of the split screen and then press (menu) > **Table** > **Remove Table** (menu) (7) (2)). You can also press **Ctrl + T**.
- ▶ To resize columns, click the table and press (menu) > **Actions** > **Resize** (menu) (1) (1)).
- ▶ To delete a column, edit an expression, or edit table settings, click the table and press (menu) > **Table** (menu) (2)).

## Changing the Appearance of the Axes

As you work with graphs, the Cartesian axes are displayed by default. You can change the appearance of the axes in the following ways:

1. Press (menu) (4) and choose the Zoom tool to use.
2. Select the axes and press (ctrl) (menu) (2) to activate the **Attributes** tool.
  - a) Press ▲ or ▼ to move to the attribute to change. For example, choose the end style attribute.
  - b) Press ◀ or ▶ to choose the style to apply.
  - c) Change any other attributes of the axes as required for your work, then press (enter) to exit the attributes tool.
3. Adjust the axes scale and tick mark spacing manually.
  - a) Click and hold one tick mark, then move it on the axis. The spacing and number of tic marks increases (or decreases) on both axes.
  - b) To adjust the scale and tick mark spacing on a single axis, press and hold (shift) and then grab and drag a tic mark on that axis.
4. Change axis end values by double-clicking them and typing new values.

- Adjust the location of the axes. To move the existing axes without resizing or rescaling them, click in and drag an empty region of the screen until the axes are in the desired location.
- Change the axes' scales by pressing (menu) > **Window/Zoom > Window Settings** (menu) (4) (1).

Type the values of your choice over the current values for x-min, x-max, y-min, y-max, Xscale and Yscale and click **OK**.

- Press (menu) > **View > Hide Axes** (menu) (2) (1) to hide or show the axes.
  - If the axes are shown on the page, selecting this tool hides them.
  - If the axes are hidden on the page, selecting this tool redisplay them.

## Tracing a Plot

Graph Trace moves through the points of a graphed function, parametric, polar, sequence or scatter plot. To enable the trace tool:

- Press (menu) > **Trace > Graph Trace** (menu) (5) (1) to move across the plot in Trace mode.

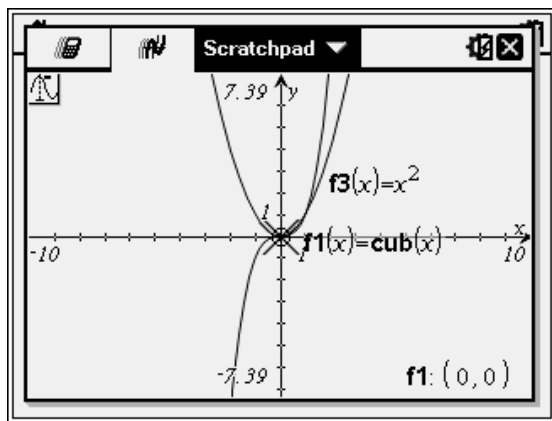

- (Optional) To change the trace step increment for tracing, press (menu) (5) (3).

After you type a different step increment, the Graph Trace tool moves across the graph in steps of that size.

Use Graph Trace to explore a plot in the following ways:

- Move to a point and hover to move the trace cursor to that point.

- Press ◀ or ▶ to move from point to point on the function's graph. The coordinates of each point traced are displayed.
- Press ▲ or ▼ to move from one plot to another. The point's coordinates update to reflect the new location of the trace. The trace cursor is positioned on the point of the new graph or plot with the closest  $x$  value to the last point identified on the previously traced function or graph.
- Type a number and press (enter) to move the trace cursor to the point on the plot with independent coordinates nearest the typed value.
- Create a persistent point that remains on the graph by pressing (enter) when the trace point reaches the point you want to label. The point remains after you exit Graph Trace mode.

#### Notes:

- The string *undef* is displayed instead of a value when you move over a point that is not defined for the function (a discontinuity).
- When you trace beyond the initially visible graph, the screen pans to show the area being traced.

3. Press (esc) or choose another tool to exit Graph Trace.

### Finding Points of Interest

You can use the tools on the **Analyse Graph** menu to find a point of interest in a specified range of any graphed function. Choose a tool to find zero, the minimum or maximum, the point of intersection or inflection or the numeric derivative ( $dy/dx$ ) or Integral on the graph.

1. Select the point of interest that you want to find on the **Analyse Graph** menu. For example, to find a zero, press (menu) (6) (1).

	non-CAS	CAS
Zero	(menu) (6) (1)	(menu) (6) (1)
Minimum	(menu) (6) (2)	(menu) (6) (2)
Maximum	(menu) (6) (3)	(menu) (6) (3)
Intersection	(menu) (6) (4)	(menu) (6) (4)

	non-CAS	CAS
Inflection	Not applicable	menu 6 5
dy/dx	menu 6 5	menu 6 6
Integral	menu 6 6	menu 6 7
Analyse Conics	menu 6 7	menu 6 8

The icon for the selected tool is displayed at the top left on the work area. Point to the icon to view a tooltip about how to use the selected tool.

- Click the graph you want to search for the point of interest, then click a second time to indicate where to start the search for the point.

The second click marks the lower bound of the search region and a dotted line is displayed.

**Note:** If you are finding the derivative (dy/dx), click the graph at the point (numeric value) to use for finding the derivative.

- Press ◀ or ▶ to move the dotted line that marks the search region, then click the point at which you want to stop the search (upper bound of the search region).

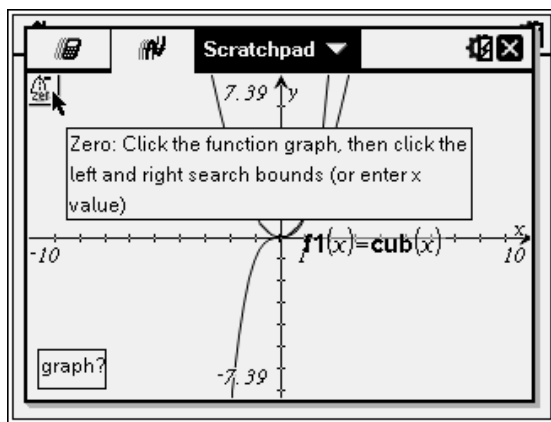

- Press (Enter) at the point to start the search. The tool shades the range.

If the search region you specified includes the point of interest, a label for the point is displayed. If you change a graph that has points of interest

identified, be sure to check for changes in points of interest. For example, if you edit the function on the entry line or manipulate a plot, the point where the graph intersects zero can change.

The labelled points of interest remain visible on the graph. You can exit the tool by pressing **(esc)** or choosing another tool.

## ***Working with Variables in the Scratchpad***

Scratchpad variables are shared between Scratchpad Calculate and Scratchpad Graph, but not with any TI-Nspire™ documents. If you use the same name for a Scratchpad variable and a variable in a document, no conflict occurs unless you attempt to copy expressions between documents and the Scratchpad.

## ***Saving the Scratchpad Contents***

You can save the Scratchpad Calculate page, the Scratchpad Graph page or both as a TI-Nspire™ document.

1. Press **(doc)**, and then select **Save to Document** (**(doc)** **(A)**).
2. Press **(enter)**.

The Save to Document dialogue box opens.

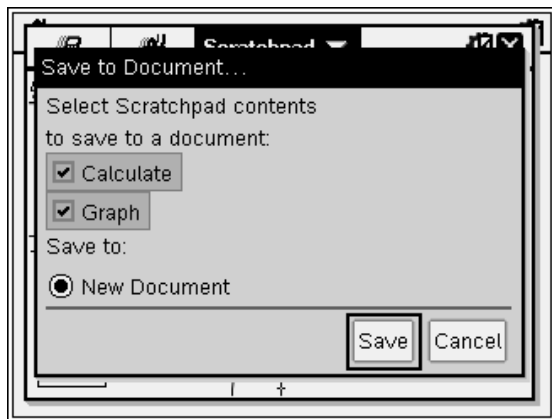

3. Select the page or pages to save.
4. If a document is open, select either New or Current document.
5. Click **Save**.

- If you selected to save to a current (open) document, the Scratchpad pages are added to the document.
- If you selected to save the Scratchpad pages to a new document, the pages are converted to an unsaved document. To save the document:
  - Press **(doc)** > **Save**. The Save As dialogue box opens.
  - Type a name for the document.
  - Select **Save** to save the new document.

## ***Clearing Scratchpad Contents***

Complete the following steps to delete the calculations and graphing work from the Scratchpad application.

1. Press **(doc)** > **Clear Scratchpad** **(doc)** **[B]**.
2. Press **(enter)** to delete the Scratchpad contents.





# Working with Documents on TI-Nspire™ Handhelds

All of the work you do with a TI-Nspire™ handheld is contained in one or more TI-Nspire™ documents, which you can share with other handheld users and with those using the computer software.

- Each document is divided into at least one, and up to 30, problems.
- Each problem contains at least one, and up to 50, pages.
- Each page can be divided into as many as four work areas.
- Each work area can contain any of the TI-Nspire™ applications (Calculator, Graph, Geometry, Lists & Spreadsheet, Data & Statistics, Notes and Vernier DataQuest™).

## Opening a Document

1. From the Home screen, select My Documents.

–or–

Press **(2)**.

The file manager opens.

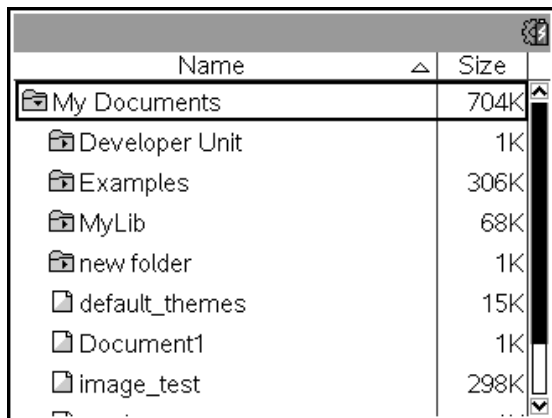

2. Navigate to the file you want to open.
  - Press **▼** to highlight the document name, then press **[Enter]** or **(enter)** to open the document.

- If the file is in a folder, press  $\blacktriangledown$  to highlight the folder, then press  $\boxed{\text{F2}}$  or  $\boxed{\text{enter}}$  to open the folder.
3. Press  $\boxed{\text{doc}\blacktriangleright}$  to open the Documents menu to access options for working with the open document.

## Creating a New Document

1. From the Home screen, select New Document.

–or–

Press  $\boxed{1}$ .

You can also press  $\boxed{\text{ctrl}}\boxed{\text{N}}$ .

A new document opens with a list of applications.

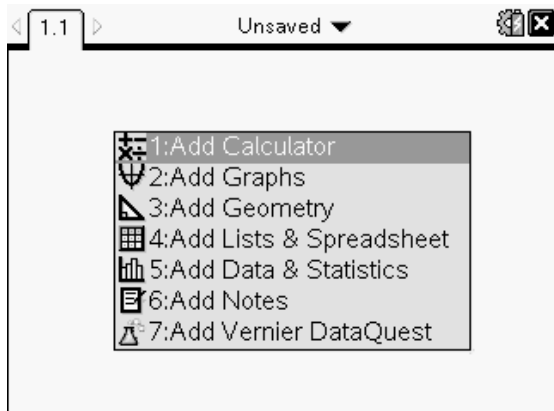

**Note:** The tab at the top left of the screen indicates that this is the first page of the first problem.

2. Use  $\blacktriangledown$  and  $\blacktriangle$  to highlight the application you want to add to the page, and then press  $\boxed{\text{enter}}$  to open the page.

## Saving Documents

To save the document in the My Documents folder:

1. Press  $\boxed{\text{doc}\blacktriangleright}$  to open the Documents menu, and then select **File > Save**.

**Note:** You can also press  $\boxed{\text{doc}\blacktriangleright}$   $\boxed{1}$   $\boxed{4}$  or  $\boxed{\text{ctrl}}\boxed{\text{S}}$  to save a document.

The Save As dialogue box opens.

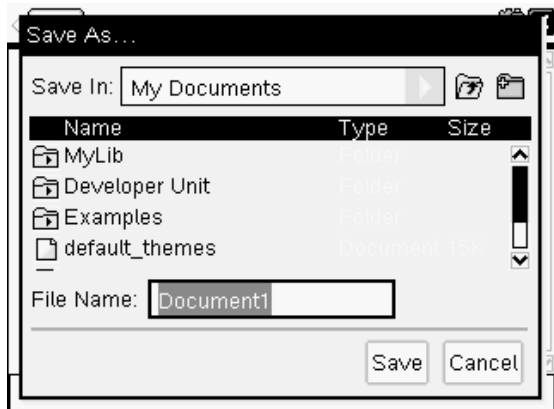

If you are saving the document for the first time, you will be asked which folder to save it to and what to name the document. The default folder is My Documents.

2. Type a name for the document.
3. Click **Save** to save the document in the My Documents folder.

### Saving a Document in a Different Folder

To save the document in a different folder:

1. From an open document, press **(docv)** **(1)** **(5)**.  
The Save As dialogue box opens.
2. Press **(shift)** **(tab)** to navigate to the list of existing folders. The first folder in the list is selected.
3. Use the **▼** and **▲** to scroll through the list of folders.
4. To select and open a folder, press **(F4)**.
5. Type a name for the document.
6. Click **Save** to save the document in the selected folder.

### Saving a Document in a New Folder

To save the document in a new folder:

1. From an open document, press **(docv)** **(1)** **(5)**.  
The Save As dialogue box opens.

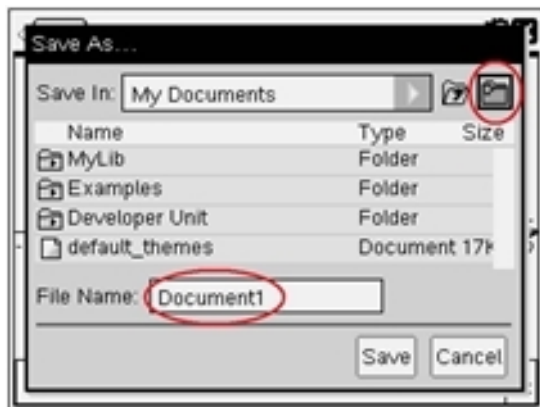

new folder icon

Type new folder name.

2. Press **(tab)** until the New Folder icon is highlighted, and then press **(enter)** to create a new folder.

The new folder is added to the bottom of the list of existing folders. By default, the folder name is "Folder1".

3. Type a name for the new folder, and then press **(enter)** to save.
4. Press **(enter)** again to open the folder.

The File Name field becomes active.

5. Type a name for the document.
6. Click **Save** to save the document in the new folder.

## ***Working with Applications***

Options for working with applications include:

- Creating a new document and selecting an application
- Adding a new page and application to an open document
- Adding multiple applications to a page in a document

### **Adding an Application**

There are multiple ways to add an application to a page:





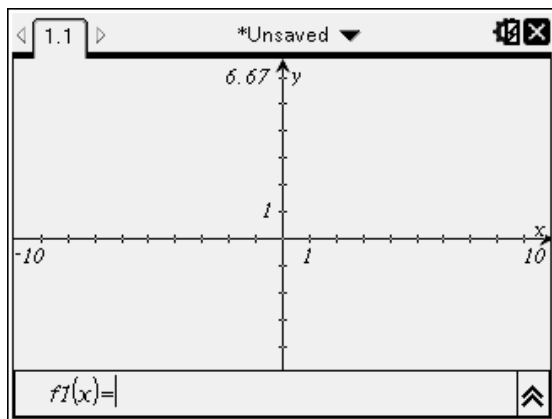

- When creating a new document, use the Touchpad or corresponding numbers to select an application from the list of applications.

- To add a new page and application to an open document, press **(ctrl)** **(doc)** and then select an application from the list.

For example, press **(2)** to add the Graph application to the page. The application opens in the work area.



You can also press **(on)**, and then select an application from the Home screen by clicking one of the following application icons:

	Calculator
	Graphs
	Geometry
	Lists & Spreadsheet
	Data & Statistics
	Notes
	Vernier DataQuest™

## Using Multiple Applications on a Page

You can add up to four applications to each page.

When you create a new document, it contains space to add one application. If you need to add more than one application to a page, you can change the layout to accommodate as many as four applications.

You can choose a standard layout, provided as a menu item or you can customise a layout to suit your needs.

### Choosing a Standard Page Layout

1. Press (doc) (5) (2) to display layout options.

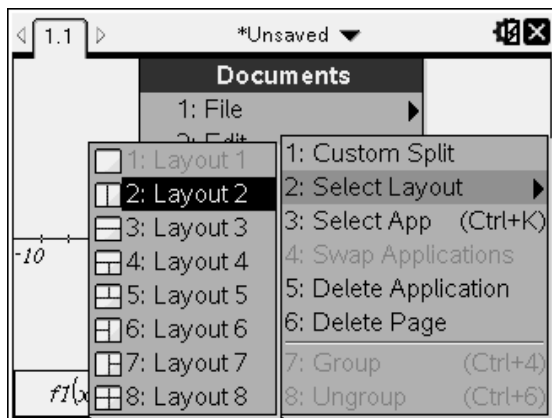

2. Press the number that corresponds to the layout you want.

For example, press (2) to create a two-pane layout, divided vertically on the page.

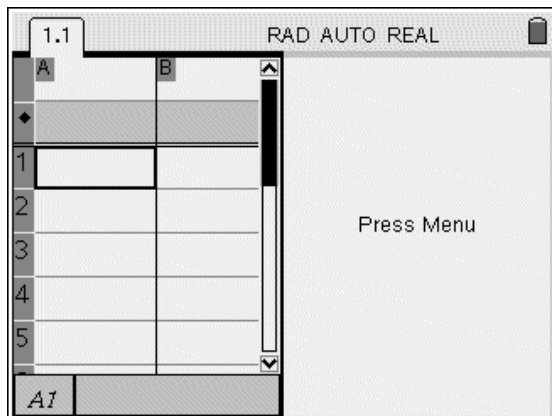

3. Press **(ctrl)** **(tab)** to move between panes. Bold lines around the pane indicate that the pane is active.
4. Press **(menu)**, then press the number of the application you want to add the new pane. For example, press **(4)** to add the Lists & Spreadsheet application.

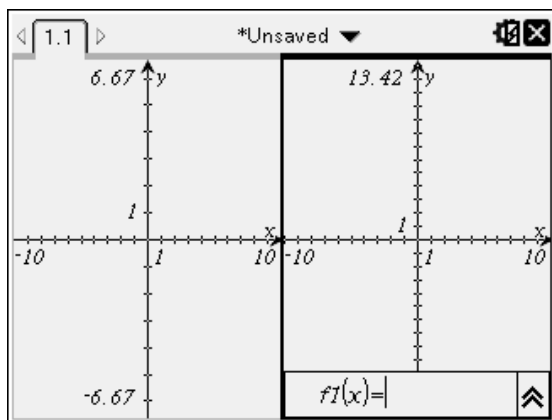

**Note:** If you need to change the layout of the page to add or delete applications, you can do so at any time. When deleting an application, select the application to be deleted first.

### **Creating a Custom Page Layout**

If the standard layouts do not meet your needs, you can customise the space allotted to applications on a page.

1. Press **(doc)** **(5)** to display layout options.

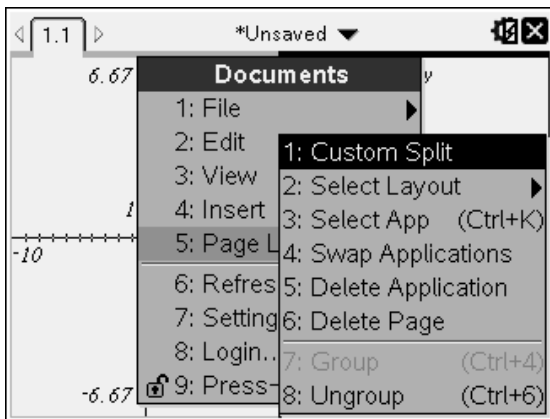

2. Press **(1)** to select the custom split option.

The standard layout is displayed with a divider between the application panes. Use the arrows **(4)** in the middle of the divider to adjust the size of the panes.

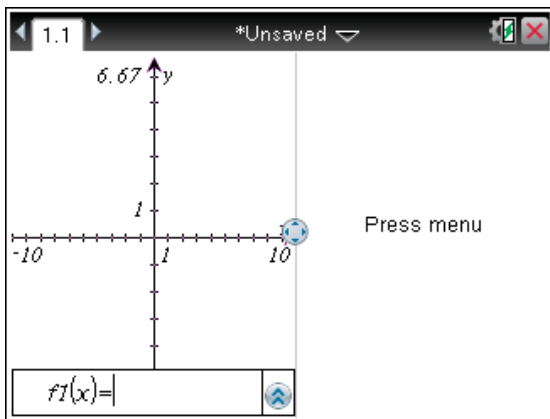

3. Press **(▲)**, **(▼)**, **(◀)** or **(▶)** to move the divider to adjust the height or width of the panes in the layout.
4. Press **(+)** or **(-)** to select a defined layout:
- Pressing **(-)** returns to a full page layout.
  - Pressing **(+)** once switches layout from a vertical layout to a horizontal layout. Press **(-)** to go back to a vertical layout.



- Pressing **(+)** twice adds a third pane to the page. Pressing **(+)** multiple times enables you to choose between a vertical and horizontal page layout with three panes.
  - Pressing **(+)** five times adds a fourth pane to the page. Press **(-)** to cycle through the previous layout options.
5. Press **()** or **(enter)** to accept the layout dimensions.
  6. Press **(ctrl) (tab)** to move between panes. Bold lines around the pane indicate that the pane is active.

### Swapping Applications on a Page

If you want to change the position of applications on a page with multiple applications, you can do so by “swapping” the positions of two applications.

1. Press **(doc) (5) Page Layout (4) Swap Application**.

The selected application is surrounded by a heavy, flashing black border and the Swap App cursor **(↻)** is displayed on the screen.

**Note:** On a two-pane page layout, the selected application automatically swaps position with the opposite pane. Press **()** or **(enter)** to complete the swap.

2. Press **(↑)**, **(↓)**, **(←)** or **(→)** to position the cursor over the application you are targeting to swap.
3. Press **()** or **(enter)** to complete the swap.

**Note:** Press **(esc)** to cancel the swap.

### Grouping Applications

To group up to four application pages into a single page:

1. Select the first page in the series.
2. From the **Document** menu, select **Page Layout > Group**.

Press **(doc) (5) (7)**.

The next page is grouped with the first page. The page layout automatically adjusts to display all the pages in the group.

### Ungrouping Pages

To ungroup the pages:

1. Select the grouped page.

- From the **Document** menu, select **Page Layout > Ungroup**.

–or–

Press (doc) (5) (8).

The material becomes individual pages for each application.

### ***Deleting an Application from a Page***

- Click the application you want to delete.
- From the **Document** menu, select **Page Layout > Delete Application**.

–or–

Press (doc) (5) (5).

The selected application is deleted.

If you want to undo the delete, press **Ctrl-Z**.

### ***Using the Application Menu***

The Application menu enables you to select tools for working with a specific application. Each application has a unique menu.

- From a blank page, press (menu) to display the Application menu.

The menu displays applications that you can add to the page.

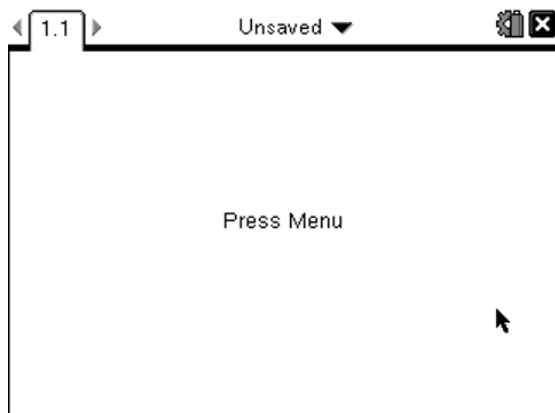

- Press the number of the application you want to add to the page. For example, press (4) to add the Lists & Spreadsheet application.

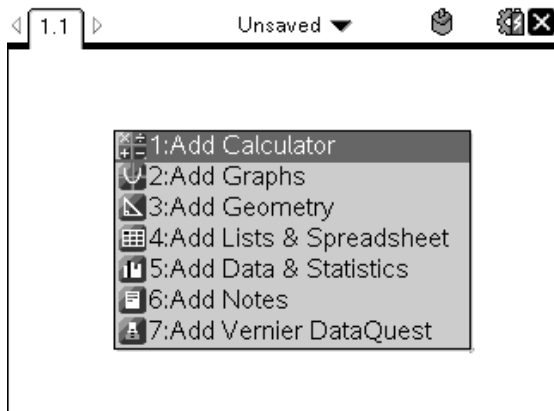

- Press **(menu)** to display the Application menu, which lists the options for working with the current application.

The example below displays the Application menu for the Lists & Spreadsheet application.

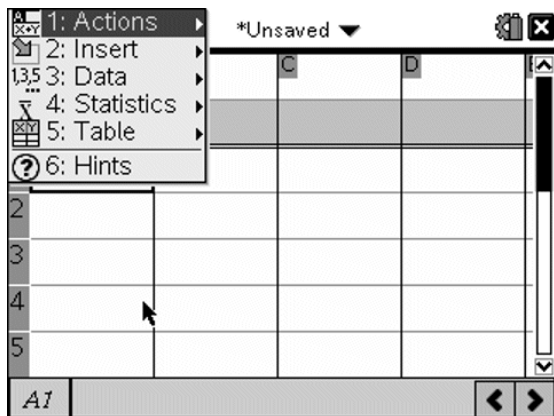

## Context Menus

Context menus display options that are specific to the selected object or the current cursor location.

### Using the Context Menu

- To access a context-sensitive menu from an application, press **(ctrl)** **(menu)**.

In the example below, the context menu displays options available for the selected cell in Lists & Spreadsheet.

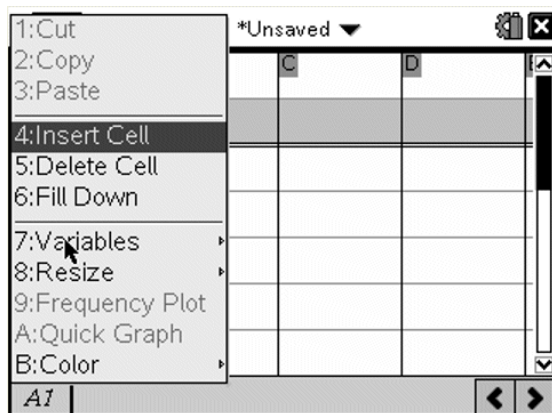

## ***Working with Problems and Pages***

The options on the **Documents** menu let you:

- Save a document
- Access edit functions such as undo, redo, cut, copy, paste and delete
- Move between pages and open the page sorter view for documents with multiple pages
- Modify page layout, insert pages or problems, delete pages and change settings
- Add problems, pages and applications to open documents
- Access page layout options

## ***Adding a Problem to a Document***

Adding problems to a document enables you to reuse variable names. A document can contain as many as 30 problems. To add a new problem:

1. Press **(doc)** **(4)** **(1)** to open the Insert options.

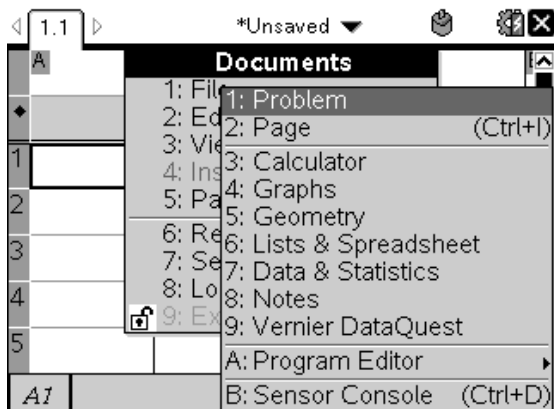

A new problem with one page is added to the document. The tab at the top left of the screen indicates that this is the first page of the second problem.

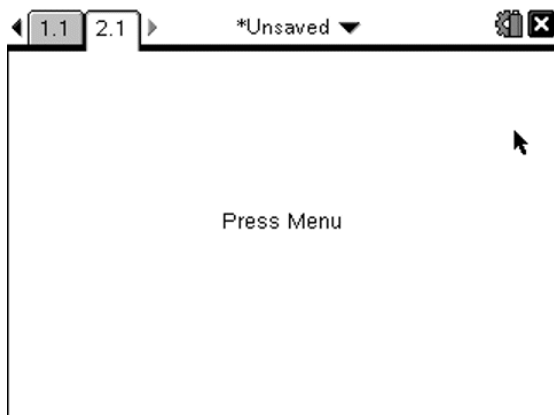

2. Press **(menu)** to open the Application menu, then press the number corresponding to the application you want to add to the new page.

## ***Viewing and Reordering Pages in a Document***

The Page Sorter displays all of the problems in your document and all pages within each problem in thumbnail format. You can use the Page Sorter to rearrange and delete pages, copy a page from one problem and paste it into another and apply templates to pages.

## Viewing Multiple Pages with the Page Sorter

Although the handheld typically displays the pages in your document one at a time, the Page Sorter lets you see all of the problems in your document and all pages within each problem in thumbnail format. You can use the Page Sorter to rearrange and delete pages and copy a page from one problem and paste it in another.

## Opening the Page Sorter from a Document

- ▶ Press **(ctrl) ▲**.

The Page Sorter screen displays all of the problems and pages in the current document.

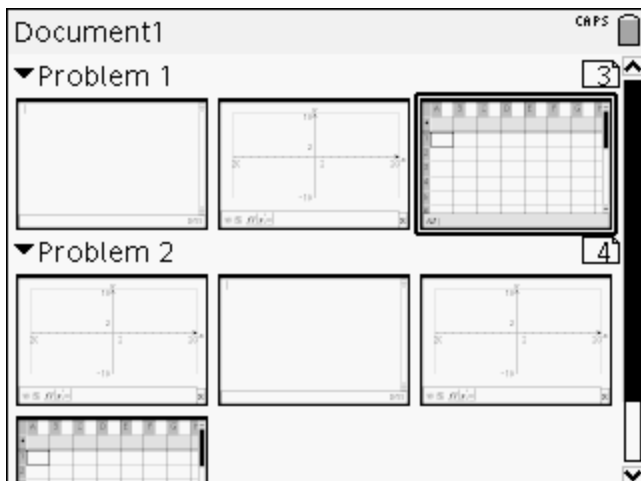



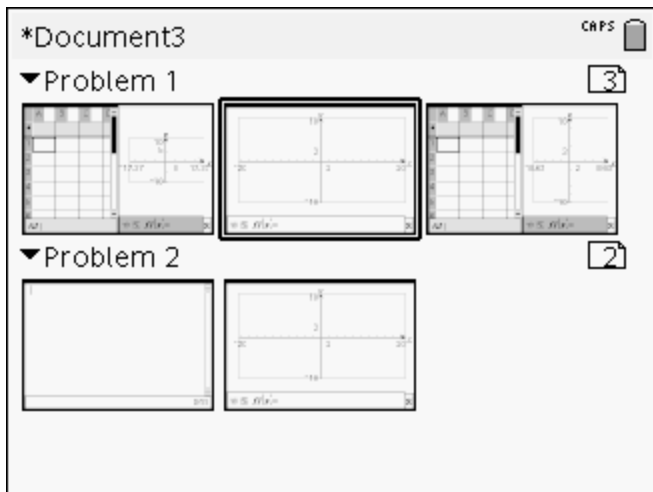

## Reordering Pages in a Problem

Use the Page Sorter (press **(ctrl) ▲**) to move a page within a problem with multiple pages:

1. Press the **◀** or **▶** key to select the page you want to move.  
A heavy border around the page indicates that it is selected.



2. Either press and hold  or press **(ctrl)**  until the grab cursor  is displayed.
3. Press **(left arrow)**, **(right arrow)**, **(up arrow)**, or **(down arrow)** to move the page to the desired position.
4. Press  or **(enter)** to finish the move.

**Note:** You can press **(esc)** to cancel.

The page moves to the new location within the problem and the counter adjusts accordingly.

### Copying a Page to Another Problem

To copy a page from one problem to another in the same document:

1. Press **(ctrl)** **(up arrow)** to open Page Sorter.
2. Press **(left arrow)**, **(right arrow)**, **(up arrow)** or **(down arrow)** to select the page you want to copy.

A heavy border around the page indicates that it is selected.

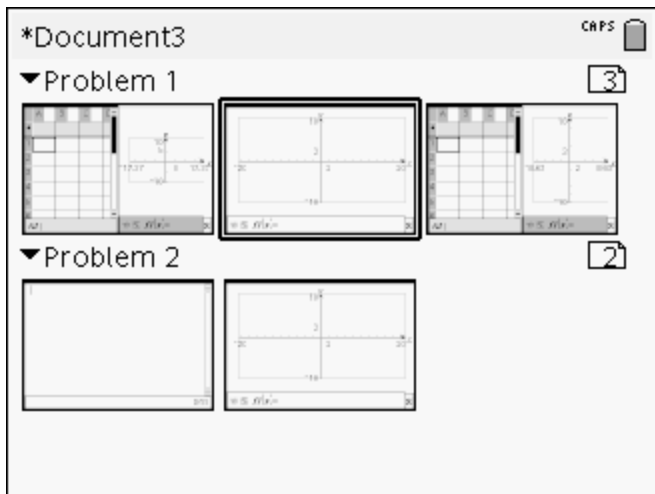

3. Press  $\text{ctrl}$   $\text{C}$  to copy the page.
4. Press  $\leftarrow$ ,  $\rightarrow$ ,  $\uparrow$  or  $\downarrow$  to select the desired position in the problem where you will paste the page. The copied page will be placed after the page you select.
5. Press  $\text{ctrl}$   $\text{V}$  to paste the page in the new location.

The page is copied to the new location within the problem and the counter adjusts accordingly.

**Note:** If the page contains variables with the same names as the new problem, a conflict may occur. Rename the variables if necessary.

## Copying a Page to Another Document

To copy a page from one document to another document:

1. Press  $\text{ctrl}$   $\uparrow$  to open the Page Sorter.
2. Press  $\leftarrow$ ,  $\rightarrow$ ,  $\uparrow$  or  $\downarrow$  to select the page you want to copy.  
A heavy border around the page indicates that it is selected.
3. Press  $\text{ctrl}$   $\text{C}$  to copy the page.
4. Press  $\text{ctrl on}$   $\text{2}$  to open My Documents.
5. Press  $\uparrow$  and  $\downarrow$  to highlight the folder containing the document you want to copy the page to.
6. Press  $\rightarrow$  to open the folder.



–or–

Press **menu** **3**.

- Press the **▲** and **▼** keys to highlight the document.
- Press **☰** or **enter** to open the document.
- Press **ctrl** **▲** to display the Page Sorter.
- Press **◀**, **▶**, **▲** or **▼** to move the page to the desired position in the document.
- Press **ctrl** **V** to paste the page in the new location.

The page moves to the new location within the problem and the counter adjusts accordingly.

## ***Copying, Pasting and Deleting Problems***

You can copy and paste a single problem from one location to another within the same document or a different document. You can also delete a problem from the document.

### **Copying and Pasting a Problem**

To copy and paste a problem:

- Open the Page Sorter.

Press **ctrl** **▲**.

–or–

Press **doc▼** **3** **3**.

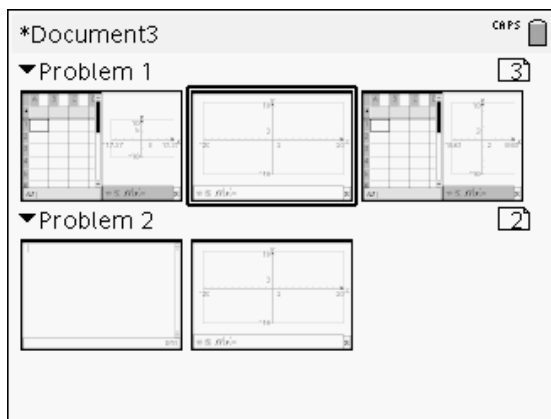

2. Select the problem. If there are multiple problems, you can press **(menu)** **(2)** to collapse the Page Sorter to list the problems by number and title only.
3. Press **(ctrl)** **(C)**.
4. Go to the location where you want the problem to appear.
5. Press **(ctrl)** **(V)**.

A duplicate problem is placed in the new location.

## Deleting a Problem

To delete a problem from the document:

1. Select the problem from the Page Sorter.
2. Press **(ctrl)** **(X)**.

The problem is deleted from the document.

## Renaming a Problem

To rename a problem:

1. With the document active, open the Page Sorter.  
Press **(ctrl)** **(▲)**.
2. Select the problem name.
3. Press **(ctrl)** **(menu)**.
4. Select **(7)** **Rename** and type the name.
5. Press **(ctrl)** **(S)** to save the change.

## Adding a Page to a Problem

Each problem can contain up to 50 pages. To add a new page to a problem:

- ▶ Press **(ctrl)** **(doc v)** or **(ctrl)** **(I)** to add a blank page and select an application.  
—or—
- ▶ Press **(fn on)** to display the **Home** screen, then point to the application you would like to add to the new page and click or tap.

A new page is added to the current problem.

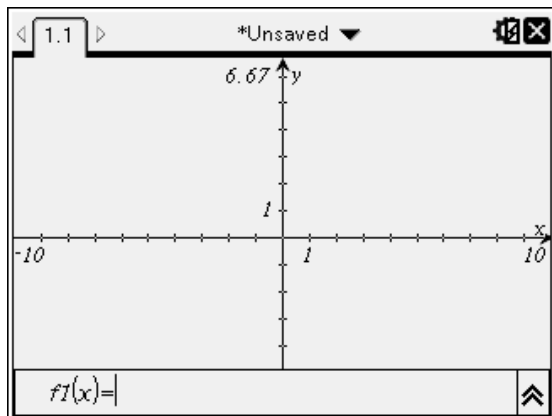

**Note:** The tab at the top left of the screen indicates that this is the second page of the second problem.

## Moving Through Pages in a Document

Tabs display up to three multiple pages. When a document contains more than three pages, arrows appear on the left and right of the tabs.

Use the following keys to navigate through your documents.

- $\text{ctrl} \leftarrow$  displays the previous page.
- $\text{ctrl} \rightarrow$  displays the next page.
- $\text{ctrl} \blacktriangle$  displays the Page Sorter.
- $\text{ctrl} \blacktriangledown$  displays the previous view.
- Use the Touchpad to click on the arrows that appear on either side of the tabs to show additional pages in a document containing more than three pages.

## Managing Documents

My Documents is a file manager in which you store and organise your documents. The example below illustrates the My Documents screen with its main parts labelled. Following the screen, you can find descriptions of each labelled part.

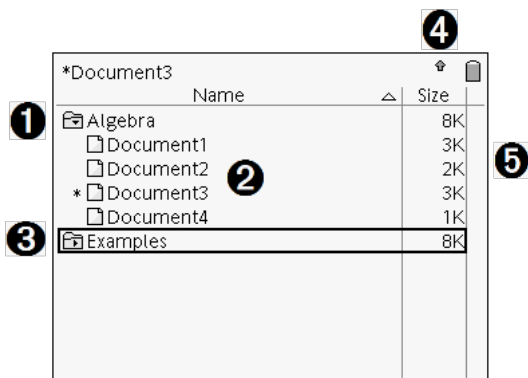

- ❶ Expanded folder
- ❷ Current, unsaved document
- ❸ Collapsed folder
- ❹ System status indicators
- ❺ File size

## Browsing Files in My Documents

To open **My Documents**:

- ▶ Press (2).

**Note:** If you are working in a page, press .

The **My Documents** screen opens, displaying all folders and files on the handheld.

Document3		CAPS
Name	▲	Size
📁 Algebra		8K
📄 Document1		3K
📄 Document2		2K
📄 Document3		3K
📄 Document4		1K
📁 Examples		8K

- To sort columns by name or size, click that column head. Click again to change the sort from ascending to descending.
- To scroll through My Documents, click or grab the scroll bar.
- To expand a single folder, point to the folder and click on the folder icon or press **(ctrl) ▶**. To collapse, click again or press **(ctrl) ◀**.
- To expand all folders, press **(menu) (7)**. To collapse, press **(menu) (8)**.

## Renaming Folders or Documents

To rename a folder or document:

1. Press the ▲ and ▼ keys to highlight the document or folder you want to rename.
2. Press **(menu) (2)**.

Document3		CRPS
Name	Size	
Algebra	8K	
Document1	3K	
Document2	2K	
Document3	3K	
Document4	1K	
Examples	8K	

The document or folder name is highlighted.

3. Type a new name and press **(enter)** to complete the change.

**Note:** Press **(esc)** to cancel.

## Creating Folders

You can create folders two different ways:

- You can create a folder when you save a new document: The **Save** and **Save As** menu commands allow you to enter a new folder name for the document.
- You can create a folder directly from the My Documents screen. Press **(menu)** **(1)**. Type a name for new folder, press **(F4)** or **(enter)** to add it.

## File and Folder Naming Conventions

Folder names must be unique. File and folder names can be very long and can include almost all characters, including spaces and punctuation.

**Note:** If you are planning to transfer these documents to your computer for use in the TI-Nspire™ software, it is best to use names that are accepted on your computer. Avoid punctuation, \, / or symbols.

### Deleting Documents and Folders

1. Press **▲** and **▼** to highlight the document or folder you want to delete.
2. Press **(ctrl)** **(menu)** **(6)**.

–or–

Press **(del)**.

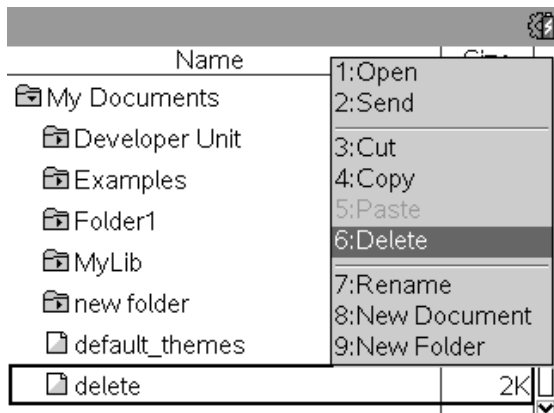

A dialogue box opens, confirming that you want to delete the file or folder.

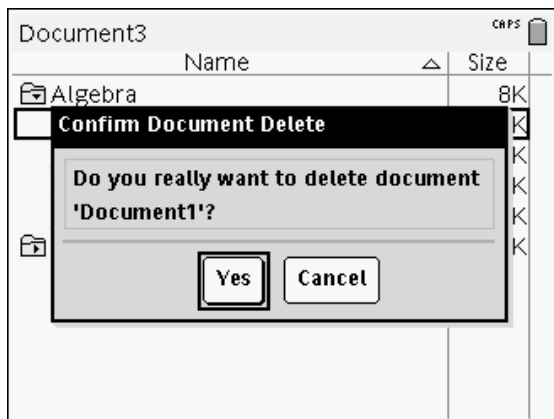

3. Press  or **(enter)** to select **Yes**.

The document is deleted.

## Duplicating Documents and Folders



Use Copy **(ctrl) [C]** and Paste **(ctrl) [V]** to duplicate documents and folders.

To copy a document to another folder, select the desired folder and then paste.



## Recovering Deleted Documents

Most operations performed in My Documents can be undone. Press **(ctrl) [Z]** (Undo) to cancel the last operation until the deleted document is restored.

## Closing a Document

1. To close a document, press   .

–or–

Press  .

If you have changed the document, you will be asked whether you want to save those changes.

2. Click **Yes** to save the document or click **No** to abandon the changes.

## Understanding the TI-Nspire™ Tools

This section provides an overview of the tools used when working with TI-Nspire™ documents on a handheld, including variables, catalogue, symbols and maths templates.

### Creating TI-Nspire™ Variables

Variables can be any portion or attribute of an object or function created within an application. Examples of attributes that can become variables are the area of a rectangle, the radius of a circle, the value contained in a spreadsheet cell or the contents of a column or a function expression. When you create a variable, it is stored in memory within the problem. You will find more information about variables in the chapter titled *Using Variables*.

### Using the Catalogue

Use the catalogue to access a list of TI-Nspire™ commands and functions, units, symbols and expression templates. Commands and functions are listed alphabetically. Commands or functions not beginning with a letter are found at the end of the list (&, /, +, - and so on). To open the catalogue:

1. From an open document, press  to open the catalogue.



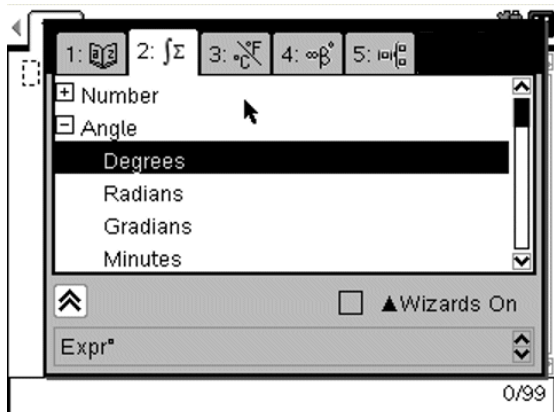

2. Press the number key corresponding to the appropriate tab.

For example, press **(2)** to show a list of maths functions.

3. Press **▼** until the item you want to insert is highlighted.

A syntax example for the selected item is displayed at the bottom of the screen.

**Note:** To see additional syntax examples of the selected item, press **(tab)** and then press **(enter)** to maximise or minimise the Help. To move back to the selected item, press **(shift) (tab)**.







4. Press **(enter)** to insert the item.

### ***About the Catalogue Window***

The catalogue window uses these tabs to categorise commands, special characters and templates in documents:

1:	Contains all commands and functions, in alphabetical order
2:	Contains all maths functions
3:	Provides a symbol palette for adding special characters
4:	Contains maths templates for creating two dimensional objects, including product, sum, square root and integral
5:	Shows public library (LibPub) objects

## CAS:

1: 	Contains all commands and functions, in alphabetical order
2: 	Contains all maths functions
3: 	Provides the values for standard measurement units
4: 	Provides a symbol palette for adding special characters
5: 	Contains maths templates for creating two dimensional objects, including product, sum, square root and integral
6: 	Shows public library (LibPub) objects

## Using Wizards

Some catalogue functions have a wizard to help you enter function arguments. To use a wizard, press **(tab)** until the **Wizards On** box is highlighted. Press  or **(enter)** to select the checkbox.

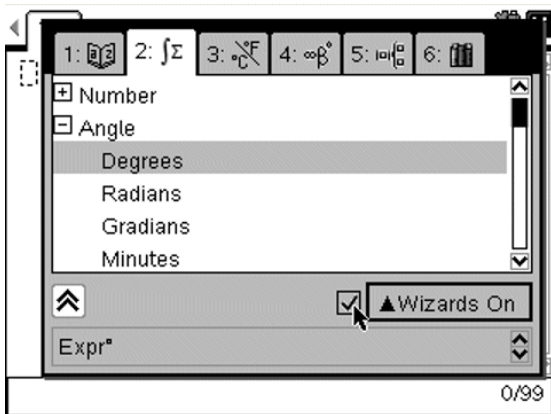

## Entering Special Characters

The symbol palette contains a subset of the objects found in the catalogue. To open the symbol palette:

1. In an open document, press **(ctrl)** **(☞)**.

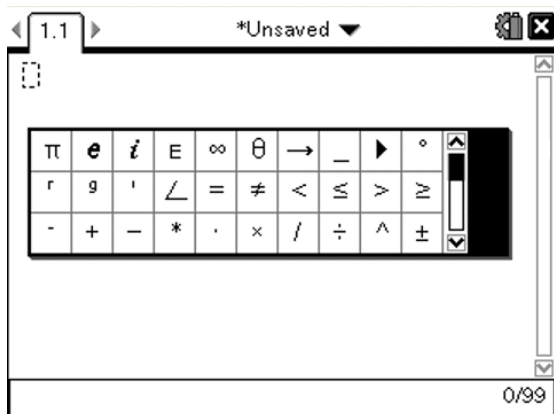

2. Press  $\leftarrow$ ,  $\rightarrow$ ,  $\blacktriangle$  or  $\blacktriangledown$  to select a symbol.
3. Press  $\text{enter}$  to insert the symbol.

### Entering Maths Expressions

Use maths expression templates to create two-dimensional objects such as summation, integral, derivative and square root. To open the maths expressions palette:

1. In an open document, press  $\text{M}(\text{S})$ .

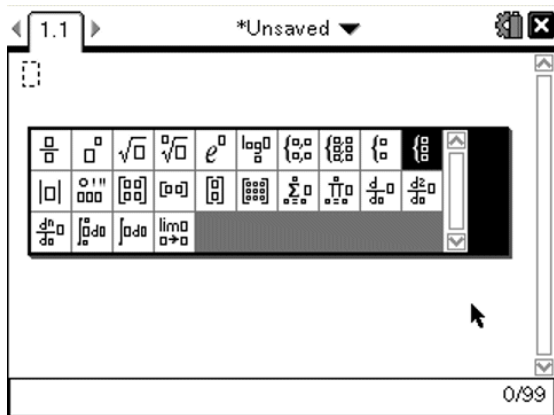



2. Press  $\leftarrow$ ,  $\rightarrow$ ,  $\blacktriangle$  or  $\blacktriangledown$  to select an expression.
3. Press  $\text{M}(\text{S})$  or  $\text{enter}$  to insert the expression.

## Entering International Language Characters

Use the  key to enter specially accented or punctuated characters in applications such as Notes that allow text input.

1. Open an application such as Notes that allows text input.
2. Type the desired text.
3. Position the cursor after the letter that you want to accent. For example, “e” while in the French locale.

Press  on the keypad. Notice that the “e” changes to “é”. Keep pressing  until you find the accented version of e that you want. Press  or the next letter of your text to accept the character and continue typing.

# Working with Images

Images can be used in TI-Nspire™ applications for reference, assessment and instructional purposes. You can add images to the following TI-Nspire™ applications:

- Graphs & Geometry
- Data & Statistics
- Notes
- Question, including Quick Poll

In the Graphs & Geometry and Data & Statistics applications, images are set in the background behind the axis and other objects. In the Notes and Question applications, the image is set at the cursor location in-line with the text (in the foreground).

You can insert the following image file types: .jpg, .png or .bmp.

**Note:** The transparency feature of a .png file type is not supported. Transparent backgrounds are displayed as white.

## *Working with Images on a Handheld*

On a handheld, images can be copied from one document to another or resized or repositioned within a document. You can also delete images from a document.









You cannot add or insert images into a document when working on a handheld. However, you can transfer a document containing an image from your computer to a handheld. If using a TI-Nspire™ CX handheld, colours are retained. If transferred to a TI-Nspire™ handheld, the colours in the image are converted to greyscale.

**Note:** If there is not enough memory on the handheld to accommodate a document containing an image, an error message is displayed.





## Copying an Image

Complete the following steps to copy an image from one document to another or from one page to another within the same document.



1. Open the document that contains the image you want to copy.
2. Select the image.



- In the Question or Notes applications, move the cursor over the image and press .
- In the Graphs & Geometry application, press    .
- In the Data & Statistics application, press   .

A border appears around the image.

3. Press  , and then click **Copy**. You can also press  .
4. Open the document where you want to paste the image or select a page in the current document.

**Note:** If you open a new document, you will be prompted to save and close the current document.









5. Press  .

**Note:** If pasting an image into the Graphs & Geometry application, press  and then press  .

The image is copied to the page in the document.

## Repositioning an Image

Complete the following steps to reposition an image on a page.

1. Open the document and navigate to the page that contains the image.
2. Select the image.
  - In the Question or Notes applications, move the cursor over the image, then press, hold and release .
  - In the Graphs & Geometry application, press    .
  - In the Data & Statistics application, press   .

A border appears around the image.
3. Move the image.
  - In the Question or Notes applications, move the cursor to the new location and press .
  - In the Graphs & Geometry or Data & Statistics applications:

- Press and hold  until the cursor changes to a four-sided arrow (





). The image floats in the background and the border changes to a dashed line.

- Move your finger over the Touchpad to move the image to the new location, and then press  or **enter** to place the image.

## Resizing an Image

Complete the following steps to resize an image on a page.

1. Open the document that contains the image.
2. Select the image.
  - In the Question or Notes applications, or in Quick Poll, move the cursor over the image and press, hold and then release . The image appears shaded.
  - In the Graphs & Geometry application, press **menu** **1** **2** **2**.
  - In the Data & Statistics application, press **menu** **3** **6**.  
A border appears around the image.
3. Move the cursor to one of the corners.

The cursor changes to a four-sided directional arrow ().

**Note:** If you move the cursor to the edge of an image, the cursor changes to a two-sided directional arrow. You can drag the image left or right to resize it, but the image will become distorted.

4. Press .

The  tool is enabled.









5. Move your finger over the Touchpad in any direction to resize the image.  
A dashed line appears to indicate the new size.
6. To accept the new size, press  or **enter**.



## Deleting an Image

Complete the following steps to remove an image from a page.

1. Open the document that contains the image.

2. Select the image.

- In the Question or Notes applications, move the cursor over the image, then press, hold and release . The image appears shaded.
- In the Graphs & Geometry application, press    .
- In the Data & Statistics application, press   .  
A border appears around the image.

3. Press  , and then select **Delete**.

The image is removed.

**Note:** In the Question and Notes applications, you can also press  to remove a selected image.



# Working in a TI-Nspire™ Navigator™ Teacher Software Classroom

If you are in a classroom where TI-Nspire™ Navigator™ Teacher Software is used, you will need to log in to class to communicate with the teacher's computer. The teacher can communicate with your handheld in the following ways:

- Send files
- Collect files
- Delete files
- Send Quick Polls and receive Quick Poll responses

The teacher can also pause and restart your handheld. When class is paused, you will receive a message on your handheld. You cannot use your handheld until the teacher releases the handheld from pause mode.

## Logging In

Complete the following steps to connect to a classroom session.

1. From the Home screen, press (5) (5). From an open document, press (doc) (8).



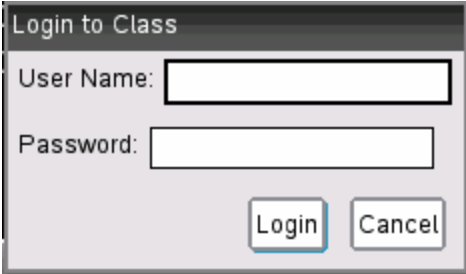

The **Login to Class** dialogue box opens.



2. Type your user name and password
3. Click **Login**.

## TI-Nspire™ Handheld Login Status Icons

The icons on the TI-Nspire™ CX, TI-Nspire™ CX CAS, TI-Nspire™ and TI-Nspire™ CAS handheld screens indicate the communication status between the handheld and the access point, wireless adapter, wireless cradle or TI-Navigator™ network. The icons indicate status as follows.

Icon	Status	Meaning
	Blinking	The handheld is searching for an access point.
	Solid	The handheld has found an access point.
	Solid	The handheld is not communicating with the adapter or cradle. Unattach the handheld from the adapter or cradle, wait for the icon to disappear, and then reattach the handheld to the adapter or cradle.
	Blinking	The handheld is connected to the network and is ready to login.
	Solid	The handheld is logged in to the network and is fully charged.

## Pausing a Class Session

There are times when a teacher may want to pause a class. Pausing a class suspends all activity on your handheld. When the teacher resumes class, the message clears and you are able to use the handheld.

## Understanding File Transfers

During a class session, the teacher can send files to student handhelds and collect or delete files from student handhelds.

**Note:** Before class starts, teachers can set up actions to send or collect files. When you log in, the files are sent or collected. If the teacher set up actions to both send and collect files, you will only see the dialogue box for the last action completed.

## Opening Sent Files

When the teacher sends a file to your handheld, the Transfers Complete dialogue box opens.

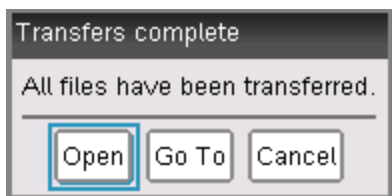

- ▶ Click **Open** to open the file. If the teacher sent multiple files, this opens the last file in the list.

**Note:** The files are received alphabetically by name, no matter which order the teacher sent them in. The last file in the list is the last alphabetical file.

- ▶ Click **Go To** to go to the location on the handheld where the file was sent. The file name is highlighted. You can open that file, or navigate to another file. If the teacher sent multiple files, the last alphabetical file in the list is highlighted.
- ▶ Click **Cancel** to dismiss the dialogue box without opening the file. Your handheld returns to the state it was in when the message was sent.

## Collecting or Deleting Files

Your teacher may collect or delete files from your handheld during a class session. For example, teachers can collect homework assignments or delete certain files prior to a test. When the teacher collects or deletes files, you receive a message on your handheld.

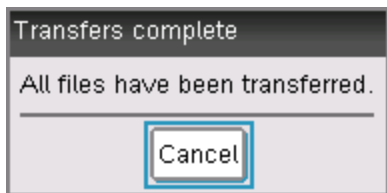

- ▶ Click **Cancel** to dismiss the message.



# Configuring Handhelds

This chapter provides information needed to:

- Maintain batteries used in the handheld.
- Change the default settings.

## *Installing the AAA Batteries*

To install the batteries shipped with your handheld, complete the following steps.

1. Remove the keypad from the front of the handheld.
  - To unlock the keypad, turn the handheld over and slide the switch on the back of the handheld to the right.



Slide switch to the right as shown here.

- Lift the keypad out.

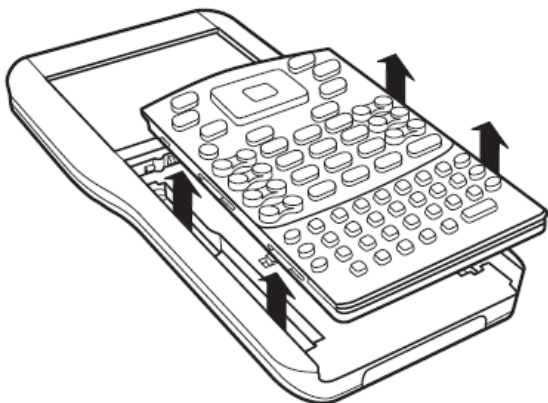

2. Insert the four alkaline AAA batteries provided with the handheld into the battery compartment. Arrange the batteries according to the polarity (+ and -) diagram.

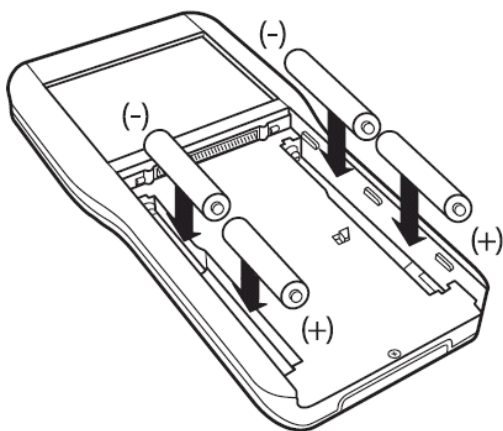

3. Replace the keypad.
  - Align the keypad with the grooves as shown. Don't try to slide the keypad in from the bottom of the handheld. Place the keypad about an inch below the screen so that it fits into the grooves and lies flat.

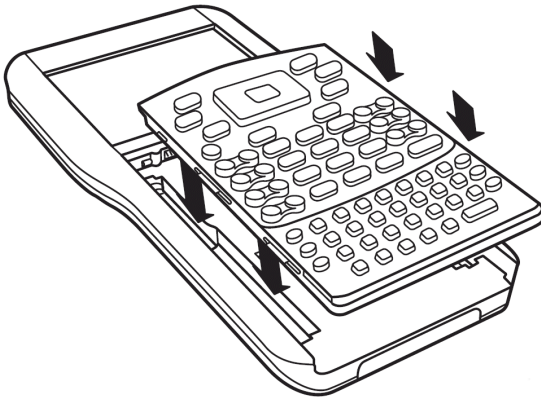

- Push the keypad firmly into place. You will hear a click and the switch on the back of the keypad is in the locked position.

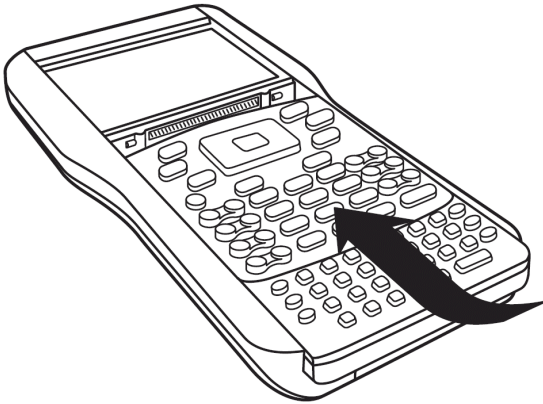

## ***Replacing AAA Batteries***

**Caution:** When removing the keypad to change AAA batteries, be certain that the handheld is completely powered down. Removing the keypad before the display is cleared may result in loss of data.

1. Save any open documents and turn off the handheld.
2. Remove the keypad from the handheld.

- Carefully remove the batteries.

**Caution:** You may need to use a tool to remove the batteries as they fit tightly in the unit. If using a tool, be careful not to damage either the batteries or the handheld.

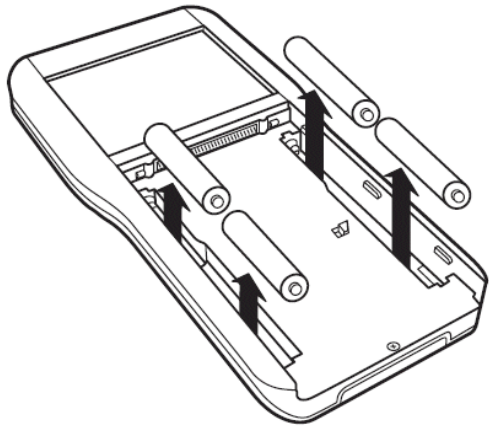

- Insert fresh batteries.

Ensure that the + side of each battery faces away from the display screen.

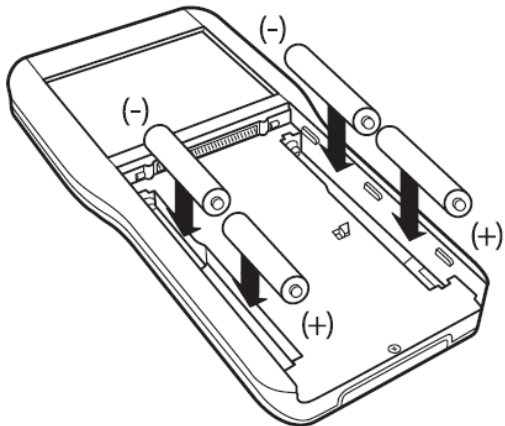

- Replace the keypad.

### ***Inserting the TI-Nspire™ Rechargeable Battery***

If purchased, complete the following steps to insert the TI-Nspire™ Rechargeable Battery into a handheld.

- Use a small screwdriver to release the panel from the back of the handheld.



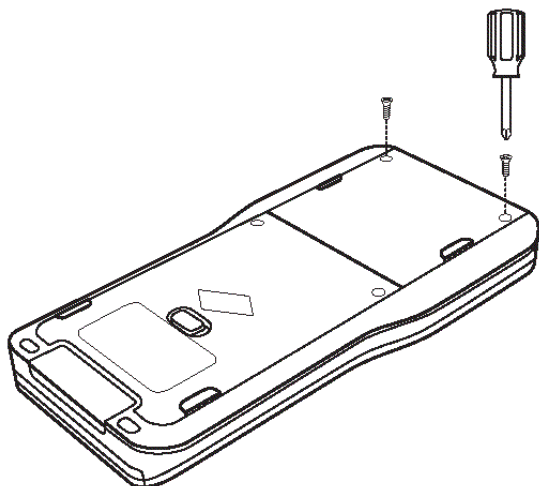

2. Remove the panel.

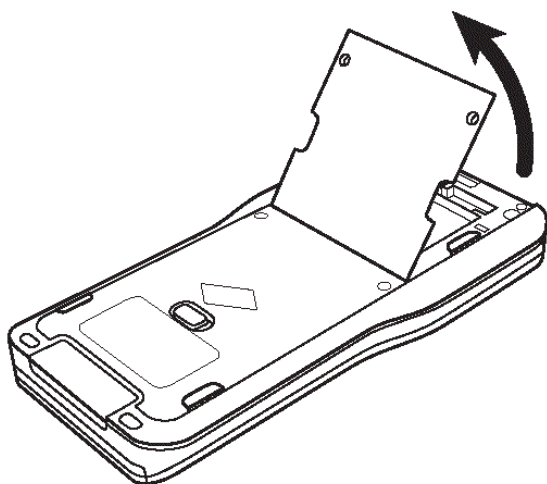

3. Insert the white connector into the jack, as shown.

**Note:** The red wire in the connector should face downward.

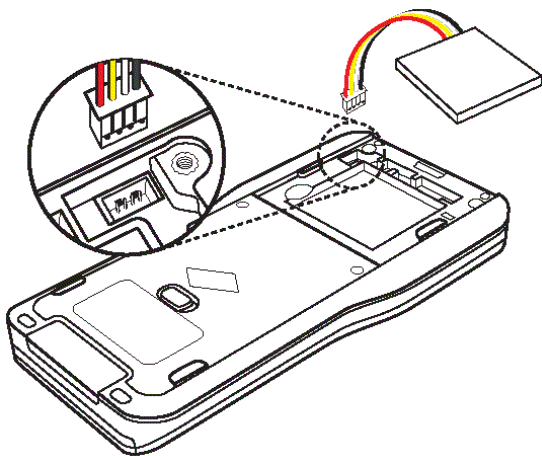

4. Thread the wire into the case to secure it. Insert the rechargeable battery into its compartment.

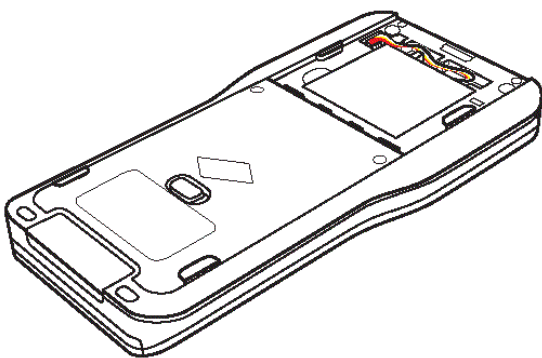

5. Replace the back panel and fasten the screws with a screwdriver.

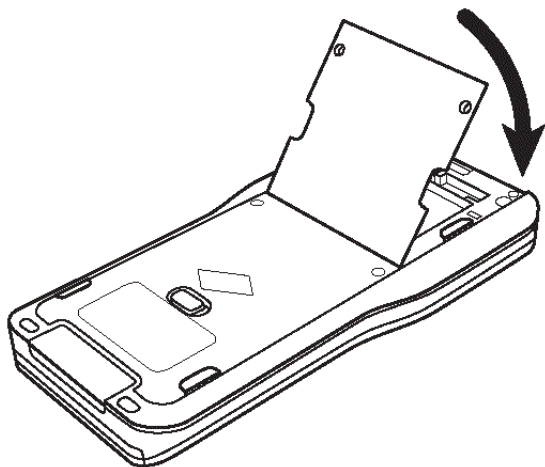

## Checking Battery Status

To check the status of both the TI-Nspire™ Rechargeable Battery and the AAA batteries in a handheld:

1. Press **(on)** to access the **Home** screen.
2. Press **(5)** **(4)** to open the **Handheld Status** window.

**Note:** From an open document, press **(docv)** **(7)** **(4)**.

## Recharging the Handheld

To recharge the TI-Nspire™ Rechargeable Battery in a handheld, connect it to either of the following power sources:

- A standard USB cable connected to a computer
- A standard, TI USB wall charger (sold separately in Europe and Asia)

The amount of time required to fully charge the battery may vary, but charging normally takes about six hours. It is not necessary to remove the TI-Nspire™ Rechargeable Battery from the handheld to recharge it. The handheld operates normally while it is attached to a charging source.

## Recharging a Battery from a Computer

To recharge a handheld from a computer, a TI-Nspire™ USB driver must be installed. USB drivers are standard with any TI-Nspire™ software, which includes:

- TI-Nspire™ Teacher Software
- TI-Nspire™ CAS Teacher Software
- TI-Nspire™ Student Software
- TI-Nspire™ CAS Student Software
- TI-Nspire™ Navigator™ Teacher Software
- TI-Nspire™ CAS Navigator™ Teacher Software

To download software that includes a driver, go to [education.ti.com/software](http://education.ti.com/software).

## Understanding the Priority of Power Sources

After installing and charging the rechargeable battery, use the handheld with or without the AAA (non-rechargeable) batteries. The handheld draws power in the following order:

- First, from a connected external power source, such as:
  - A computer connected through a standard USB cable
  - A TI USB wall charger (sold separately in Europe and Asia)
- Second, from the TI-Nspire™ Rechargeable Battery (sold separately)
- Last, from the AAA (non-rechargeable) batteries

## Disposing of Used Batteries Safely and Properly

Do not mutilate, puncture or dispose of batteries in fire. The batteries can burst or explode, releasing hazardous chemicals. Discard used batteries according to local regulations.

## *Changing Handheld Settings*

Use the options on the Settings menu to change or view the following settings:

- Change language
- Settings (General and Graphs & Geometry)
  - Define or restore settings for open documents and the Scratchpad
  - Define or restore default settings for the handheld
- Handheld Setup

- Status
- Login

**Note:** Not all options are accessible at all times. Options that are unavailable are dimmed.

## Opening the Settings Menu

- ▶ From the Home screen, press (5) or use the Touchpad to select Settings. The Settings menu opens.

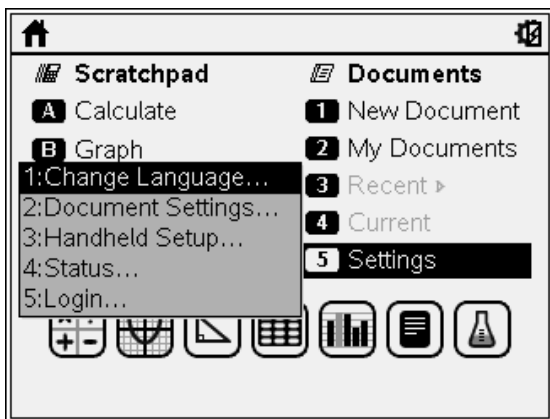



## Changing the Preferred Language

Complete the following steps to change the preferred language:

1. From the Home screen, press (5) or select **Settings** to open the menu.
2. From the menu, select **Change Language** or press (1).

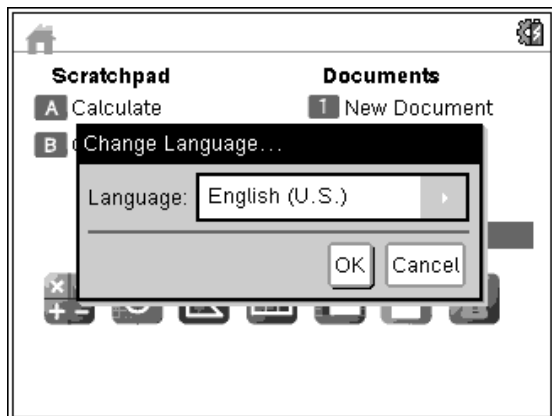
The Change Language dialogue box opens.



3. Press **▶** to open the drop-down list.
4. Press **▼** to highlight a language, and then press  or **enter** to select it.
5. Press **tab** to highlight the **OK** button, and then press  or **enter** to save the language selection.

## ***Customising the Handheld Setup***

Handheld setup options enable you to customise options to suit your needs.

- Font size (small, medium or large).
- Power standby. (1, 3, 5, 10 or 30 minutes).
  - Use this option to extend battery life.
  - By default, the handheld automatically powers down after three minutes of inactivity.
- Hibernate (1, 2, 3, 4, 5 days or never).
  - Use this option to extend battery life.
  - When hibernating, the handheld saves current work in memory.
  - When you turn the handheld on again, the system reboots and opens saved work.
- Pointer speed (slow, normal or fast).
- Enable tapping to click.

## **Changing Handheld Setup Options**

1. From the **Home** screen, press **(5)** **(3)** (**Settings > Handheld Setup**).

The Handheld Setup dialogue box opens.

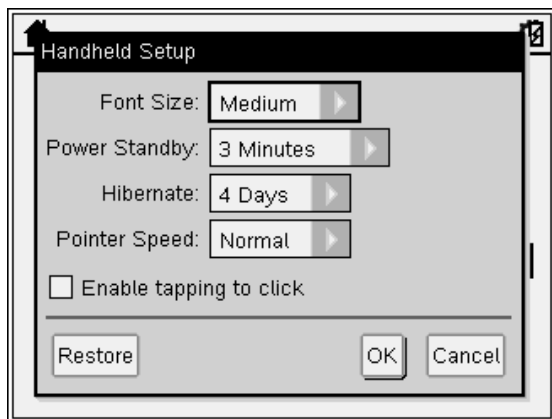

2. Press **tab** until the desired category is highlighted.
3. Press **▶** to view the list of possible settings.
4. Press **▼** to highlight the desired setting.
5. Press **↵** or **enter** to select the new setting.
6. When you have changed all the settings to suit your needs, press **tab** until **OK** is highlighted, and then press **↵** or **enter** to apply your changes.

**Note:** Click **Restore** to return the handheld to the factory settings.

**Note:** When operating in TI-84 mode, you cannot modify the power standby or hibernate options. TI-84 mode will follow the same power settings established within the TI-Nspire™ native mode.

## ***Customising Document Settings***

Document settings control how the handheld displays and interprets information in TI-Nspire™ documents and in Scratchpad. All numbers, including elements of matrices and lists, are displayed according to the document settings. You can change the default settings at anytime and you can also specify settings for a particular document.

Document settings and their possible values are listed in the following table.

Field	Values
Display Digits	Float Float1 - Float12 Fix0 - Fix12
Angle	Radian Degree Gradian
Exponential Format	Normal Scientific Engineering
Real or Complex	Real Rectangular Polar
Calculation Mode	Auto CAS: Exact Approximate  <b>Note:</b> Auto mode displays an answer that is not a whole number as a fraction except when a decimal is used in the problem. Exact mode (CAS) displays an answer that is not a whole number as a fraction or in symbolic form, except when a decimal is used in the problem.
Vector Format	Rectangular Cylindrical Spherical
Base	Decimal Hex Binary
Unit System (CAS)	SI Eng/US



## Changing Default Document Settings

Complete the following steps to define default document settings for TI-Nspire™ documents and Scratchpad.

1. Save and close any open documents.
2. From the Home screen, press **(5)** **(2)** (**Settings > Document Settings**).

The Document Settings dialogue box opens.

**Note:** If a document is open, the Document Settings dialogue box also contains an **OK** button. If you select **OK**, settings are only applied to the open document.

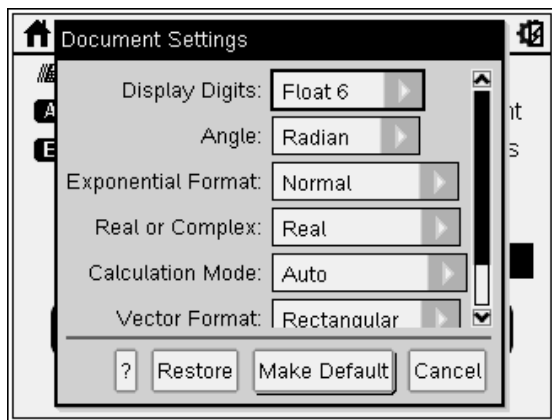

3. Press **(tab)** to move through the list of settings. Press **▲** to move backward through the list.

A bold line around a box indicates it is active.

4. Press **▶** to open the drop-down list to view the values for each setting.
5. Press the **▲** and **▼** keys to highlight the desired option, then press **(enter)** or **(tab)** to select the value.
6. Select **Make Default**.

The Apply and Save as Default dialogue box opens.



7. Click **OK** to save the settings as default settings that will be applied to all TI-Nspire™ documents and to Scratchpad.

## Changing Document Settings in a TI-Nspire™ Document

Complete the following steps to change document settings for an open TI-Nspire™ document. You can apply the settings to the current document only or choose to make the settings the default settings for the open document and all future documents.

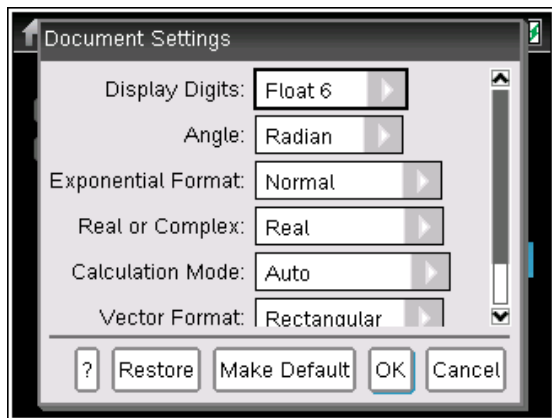

1. From an open document, press  $\text{Ctrl}$  (on) 5 2 ( $\text{Ctrl}$  on) > **Settings > Document Settings**).

The Document Settings dialogue box opens.



2. Press **(tab)** to move through the list of settings. Press **▲** to move backward through the list.

A bold line around a box indicates it is active.

3. When you reach the desired setting, press **▶** to open the drop-down list to view values for each setting.
4. Press the **▲** and **▼** keys to highlight the desired option, then press **()** or **(enter)** to select the value.
5. Click **OK** or press **()** or **(enter)** to apply the new settings only to the open document.

The Home screen opens and the new settings are only applied to the open document.

To apply the new settings to the open document *and* to documents created in the future:

- Select **Make Default** and press **()** or **(enter)**.
- Click **OK** to apply the settings to any open documents and save the settings as defaults for new documents and for Scratchpad.

## Restoring Document Settings

Complete the following steps to restore the original factory settings to open or new documents and to the Scratchpad.

1. From the Home screen, press **(5)** **(2)** (**Settings > Document Settings**).  
The Document Settings dialogue box opens.
2. Use the Touchpad or press **(tab)** to select **Restore**, then press **(enter)**.  
The Restore Defaults dialogue box opens.

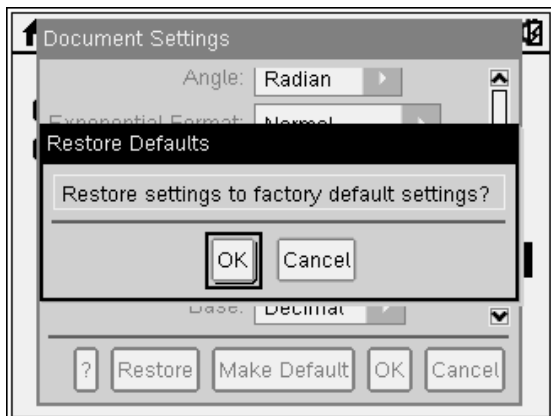

3. Click **OK** to restore settings to the factory default settings.
4. Press **OK** or **(esc)** to return to the **Home** screen.

## ***Customising Graphs & Geometry Settings***

Graphs & Geometry settings control how information is displayed in open problems and in subsequent new problems. When you customise application settings, your selections become the default settings for all of your work in the Graphs & Geometry application.

Complete the following steps to change the Graphs & Geometry Settings and make these settings the default for all new graphs and geometry documents and Scratchpad.

1. Open a document with the Graphs or Geometry application active.
2. Press **(menu)** **(9)** **(menu) > Settings**.

The Graphs & Geometry Settings dialogue box opens.

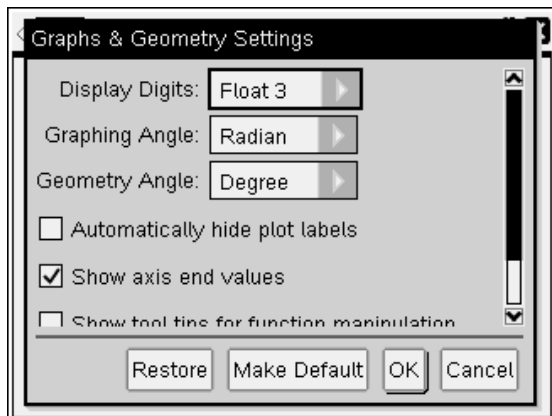

3. Press **(tab)** to move through the list of settings. Click **▶** to open the drop-down list to view the values for each setting.

Field	Values
Display Digits	Auto Float Float1 - Float12 Fix0 - Fix12
Graphing Angle	Auto Radian Degree Gradian
Geometry Angle	Auto Radian Degree Gradian

4. Press **▼** to view the values, then press **(F5)** or **(enter)** to select a value.
5. In the lower half of the dialogue, select a checkbox to enable an option or clear a checkbox to disable an option.

Checkbox	Operation when selected
Automatically hide plot labels	Plot labels display only when a plot is hovered, selected or grabbed.
Show axis end values	Displays a numeric label at the least and greatest values visible on an axis.
Show tool tips for function manipulation	Shows helpful information as you manipulate function graphs.
Automatically find a point of interest	Shows zeros, minima and maxima for graphed functions and objects while tracing function graphs.

6. Choose one of the following options:

- To apply the customised settings to ALL graphs and geometry documents, click **Make Default**. When the Apply and Save as Default dialogue box opens, click **OK**.
- To apply the settings to the open document only, click **OK**.
- To restore default settings, click **Restore**. When the Restore Defaults dialogue box opens, click **OK**.
- Click **Cancel** to close the dialogue box without making changes.

## Viewing Handheld Status

The **Handheld Status** screen provides the following information about the current state of the handheld:

- Status of the AAA and the rechargeable batteries
- Software version
- Available space
- Network (if any)
- Your student login name and whether you are logged in
- About

## Opening the Handheld Status Screen

1. From the Home screen, press (5) (4) (**Settings > Status**).

The **Handheld Status** screen opens.

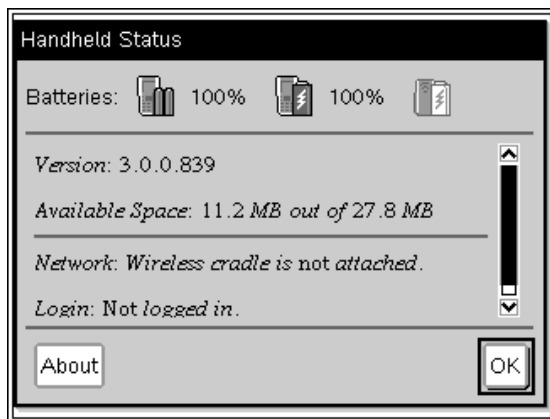

2. Click **OK** to close the Handheld Status screen.

### Viewing Handheld Details

The About screen provides additional information about the handheld type, the operating system (OS) version and the product ID.

1. From the Home screen, press (5) (4).

The **Handheld Status** screen opens.

2. Click **About** to view details about the handheld.

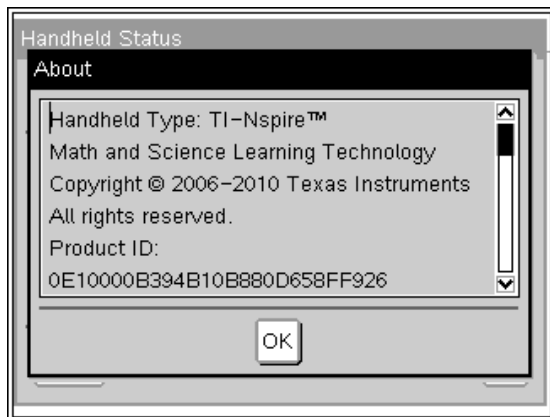

3. Click **OK** to close the **About** dialogue box.
4. Click **OK** to return to the Home screen.

## Using Wireless Communication Hardware

Teachers using TI-Nspire™ Navigator™ Teacher software in the classroom can use the wireless cradle along with the TI-Nspire™ access point to establish a wireless connection between the teacher computer and any TI-Nspire™ handheld. This section provides information about how to attach wireless communication hardware to a TI-Nspire™ handheld.

### Attaching a Wireless Cradle to a Handheld

The wireless cradles can also be used with all TI-Nspire™ handhelds to wirelessly connect to the teacher computer. To connect a handheld to a wireless cradle:

1. Slide the lock on the back of the cradle to the OFF position.

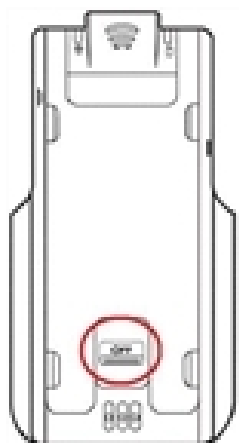

Lock in OFF position.

2. To attach the handheld, face the screen upward and slide the handheld onto the top of the TI-Nspire™ Navigator™ wireless cradle. Be sure that both sides of the handheld are inserted into both of the side guides.

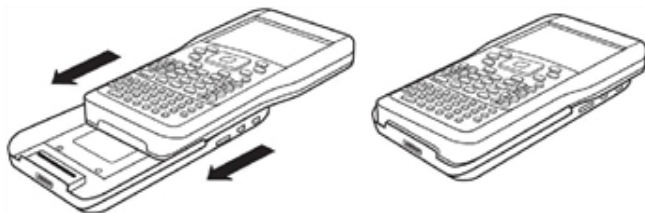



3. Press firmly to make a good connection. When properly connected, the TI-Nspire™ handheld appears to be sitting on top of the cradle.
4. Lock the handheld in place by sliding the lock on the back of the cradle to the ON position.

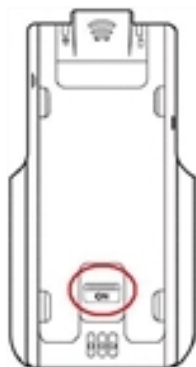

Lock in ON  
position.



# Connecting Handhelds and Transferring Files

This chapter describes how to connect one TI-Nspire™ handheld to another, how to connect handhelds to a computer and how to transfer files between them.

The TI-Nspire™ handhelds have a USB port that enables connectivity with another TI-Nspire™ handheld or with a computer.

**Note:** When using the TI-Nspire™ TI-84 Plus keypad, you can connect with another TI-Nspire™ handheld using the TI-Nspire™ TI-84 Plus keypad or a TI-84 Plus using the USB port or the I/O port.

## Connecting Handhelds

### Using USB Cables

You can use USB cables to connect two TI-Nspire™ handhelds, to connect a TI-Nspire™ handheld to a computer or to connect one TI-Nspire™ handheld using TI-Nspire™ TI-84 Plus keypad to another.

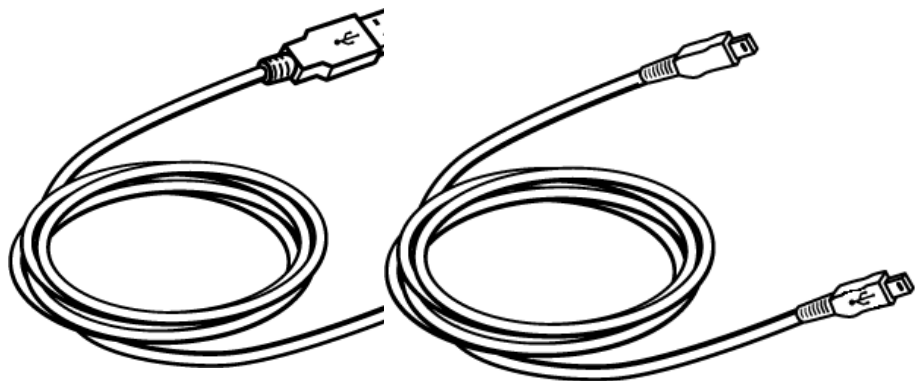

TI-Nspire™ USB connection cable to connect handheld to a computer.

TI-Nspire™ handheld mini-USB cable to connect two TI-Nspire™ handhelds.

## Connecting Two TI-Nspire™ Handhelds with the Mini-USB Cable

You can connect two handhelds as long as both handhelds are using the same keypad. You cannot connect a handheld using the TI-Nspire™ TI-84 Plus keypad to a handheld using the native TI-Nspire™ keypad.

The TI-Nspire™ handheld USB port is located in the centre on the top of the TI-Nspire™ handheld.

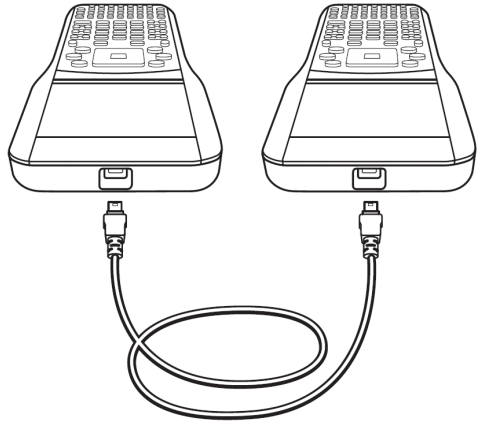

The USB port is located on the top of the TI-Nspire™ CX handheld on the right side when holding the handheld with the screen facing you.

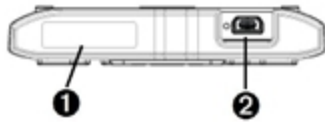

- ❶ Port for connecting a wireless adapter.
- ❷ USB port on the CX handheld.

To connect the handhelds:

1. Firmly insert either end of the mini-USB cable into the USB port.
2. Insert the other end of the cable into the receiving handheld's USB port.

## Connecting the TI-Nspire™ Handheld to a Computer

1. Firmly insert the mini-USB end of the cable into the port at the top of your handheld.

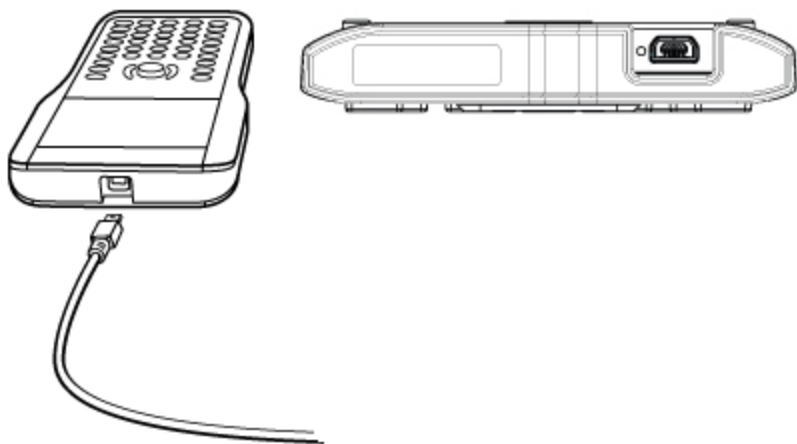

2. Firmly insert the USB end of the cable into the USB port of the computer.

## ***Transferring Files to and from Handhelds***

You can send documents, Operating System (OS) files and folders to another TI-Nspire™ handheld.

### **Rules for Transferring Files and Folders**

- You can transfer documents and OS files.
- Operating systems are not interchangeable between different handheld types. For example, you cannot transfer a CAS operating system to a non-CAS handheld.
- If a document with the same name as the one you are sending already exists on the receiving handheld, the document will be renamed. The system appends a number to the name to make it unique. For example, if Mydata existed on the receiving handheld, it would be renamed Mydata (2).

Both the sending and receiving handhelds will display a message that shows the new name.

- There is a 255-character maximum length for a file name, including the entire path. If a transmitted file has the same name as an existing file on the receiving handheld and the file names contain 255 characters, the name of the transmitted file will be truncated to enable the software to follow the renaming scheme described in the previous paragraph.

- All variables associated with the document being transmitted are transferred with the document.
- Transmissions will time out after 30 seconds.

**Caution:** Some older TI-Nspire™ handhelds cannot receive folders; only files. If you receive an error in sending to an older TI-Nspire™ handheld, see *Common error and notification messages*.

## Sending a Document or Folder to Another Handheld

1. Ensure the two handhelds are connected.
2. Open the My Documents file browser and navigate to the file or folder you want to transfer.
3. Press the ▲ and ▼ keys on the Touchpad to highlight the document or folder you want to send.
4. Press **doc▼** **1** **6** to select **Send** from the Documents menu.

TI-Nspire™ handheld: Press **doc▼** **1** **6**.

5. The file transfer begins. A progress bar shows the status of the transfer. There is also a cancel button in the Sending... dialogue box to enable you to cancel the transmission while it is in progress.

At the end of a successful transmission, the message “<Folder / File name> transferred as <Folder / File name>.” is displayed. If the file had to be renamed on the receiving handheld, the message will show the new file name.







## Receiving a Document or Folder

No action is required by the user of the receiving TI-Nspire™ handheld. Handhelds are automatically powered on when the cable is attached.

At the end of a successful transmission, the message “<Folder / File name> received.” is displayed. If the file had to be renamed, the message will show the new file name.

**Caution:** Some older TI-Nspire™ handhelds cannot receive folders; only files. If you receive an error in sending to an older TI-Nspire™ handheld, see *Common error and notification messages*.

## Cancelling a Transfer

1. To cancel a transmission in progress, press **Cancel** on the sending handheld. The user of either handheld can also press .  
TI-Nspire™ handheld: press .
2. Press  or  to cancel the transmission error message.  
TI-Nspire™ handheld: press  or .

## *Transferring Files Between Computers and Handhelds*

In the Documents Workspace, teachers and students can use the “drag and drop” method to quickly transfer files and folders from a computer to a handheld or transfer files from a handheld to a computer.

1. Connect the handheld to the computer using a standard A to mini-B USB cable.
2. In the TI-Nspire™ software, open the Documents Workspace.
3. In the Documents Toolbox, click  to open the Content Explorer.

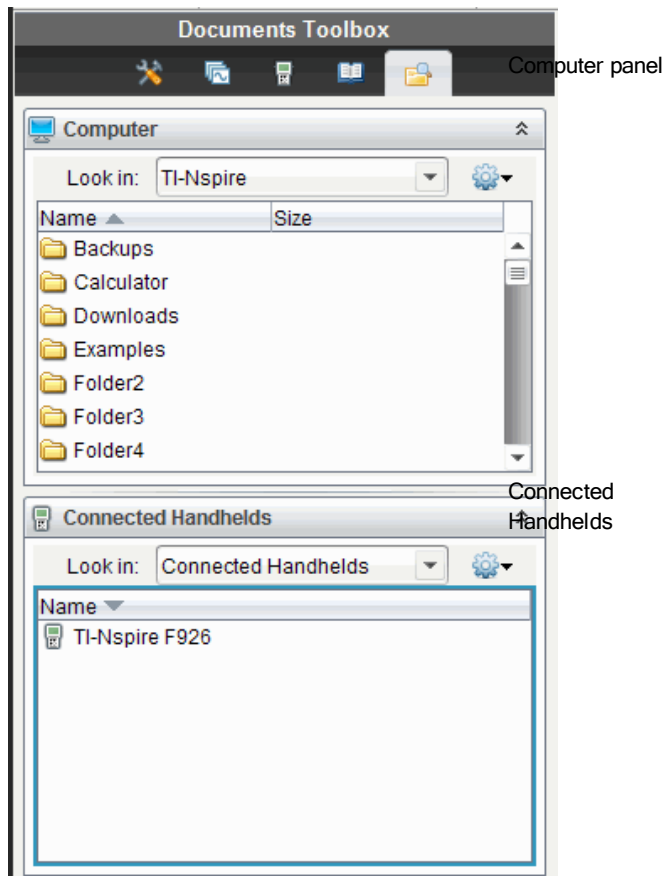

4. Navigate to the folder that contains the file you want to transfer.
  - To transfer a file from a handheld to the computer, click the file, and then drag the file to a folder in the Computer panel.
  - To transfer a file from the computer to a handheld, click the file, and then drag the file to a connected handheld.

**Note:** Those using the TI-Nspire™ Teacher Software or the TI-Nspire™ Navigator™ Teacher Software can also use options in the Content Workspace to transfer files from a handheld to a computer.



## Using the Save to Handheld Option

In the Documents Workspace, you can also use the Save to Handheld option on the File menu to transfer a file to a connected handheld when you want to save a file to a specific folder on the handheld.

1. Ensure the handheld is connected to the computer.
2. In the Computer panel, navigate to the folder where the file is located.
3. Click the file.
4. Click **File > Save to Handheld**. The Save to Handheld dialogue box opens.

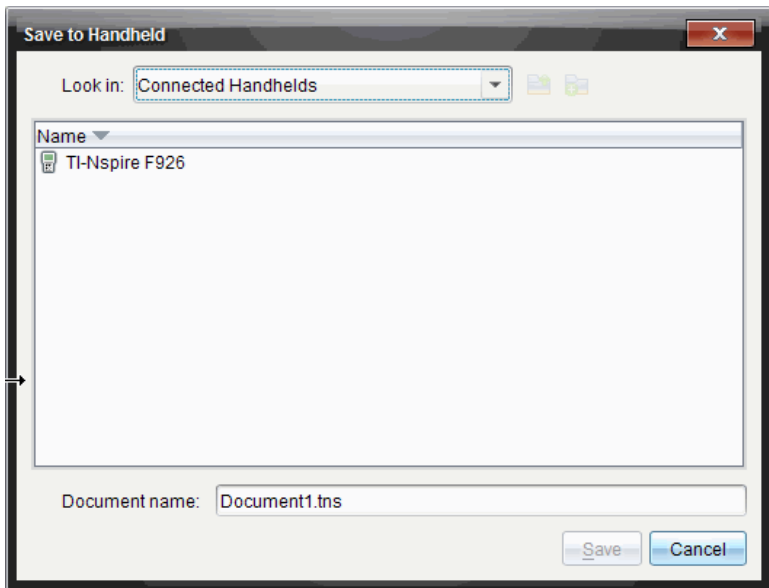

5. Double-click the handheld name, and then navigate to the folder where you want to save the file.
6. Click **Save**. The file is saved to the selected folder and the Save to Handheld dialogue box closes.

## Handling Errors Resulting from Sending Folders

If you receive an error after attempting to send a file, it may mean the receiving handheld has an operating system that does not support the transfer. To resolve this, update the receiving handheld's OS and try the send again.

## Common Error and Notification Messages

Shown on	Message and Description
Sending handheld	<p>"This folder structure is not supported on the receiving handheld. The receiving handheld's OS may need to be updated, which you can do by selecting Send OS from the My Documents menu."</p> <p>OK</p>
	<p>If you get an error when sending a folder to an older TI-Nspire™ handheld, try updating the OS on the receiving handheld. If the error persists, you may have to send the files individually.</p>
Sending handheld	<p>"Transfer failed. Check cable and try again."</p> <p>OK</p>
	<p>This message is displayed if a cable is not attached to the sending handheld's link port. Remove and then reinsert the cable and try the document transmission again.</p> <p>Click <b>OK</b> to cancel the transmission message.</p> <p><b>Note:</b> The sending handheld may not always display this message. Instead, it may remain BUSY until you cancel the transmission.</p>
Sending handheld	<p>"Receiver does not have enough storage space for file transfer."</p> <p>OK</p>
	<p>This message indicates that the receiving handheld does not have enough memory to accept the file being transmitted. The user of the receiving handheld must free space to obtain the new file. To do this:</p> <ul style="list-style-type: none"> <li>• Delete unneeded files.</li> <li>• Store files on a computer for later retrieval, and then delete them from the TI-Nspire™ handheld.</li> </ul>

<b>Shown on</b>	<b>Message and Description</b>
Sending handheld	<p>"&lt;folder&gt;/&lt;filename&gt; transferred as &lt;folder&gt;/&lt;filename (#) ."</p>
	<p>This message is displayed at the end of a successful transfer when the file had to be renamed because a file already exists on the receiving handheld with the original name. The transmitted file is renamed by appending a number to the end of the name. Rename numbering always begins with (2) and can increment by one, as needed.</p>
Sending handheld	<p>"&lt;folder&gt;/&lt;filename&gt; transferred as &lt;folder&gt;/&lt;new filename&gt;."</p>
	<p>This message indicates that a new folder was created on the receiving handheld to contain the transmitted document.</p>
Receiving handheld	<p>"&lt;folder&gt;/&lt;filename(x)&gt; received."</p>
	<p>This message indicates that the receiving handheld has a document with the same name as the document being sent.</p>
Receiving handheld	<p>"&lt;new folder&gt;/&lt;new filename&gt; received."</p>
	<p>This message indicates that a new folder has been created to contain the transmitted document.</p>
Receiving handheld	<p>"Transfer failed. Check cable and try again." OK</p>
	<p>This message indicates that the cable is not correctly attached to the receiving handheld's link port. Remove the cable then reattach it and try the transmission again. Click <b>OK</b> to cancel the transmission message.</p>



# Memory and File Management

The TI-Nspire™ Handheld comes equipped with 64 MB of memory. Of the total memory, 32 MB is dedicated to Flash storage and 32 MB is RAM. When the operating system is loaded, and as documents are created and stored on the handheld, memory is used and you may find that you need to free or restore memory after several months of use. If there is insufficient memory on the handheld, use one of the following options to restore space on the handheld:

- Delete documents and folders you no longer use.
- Back up files and folders to another handheld or computer.
- Reset the memory, which deletes ALL files and folders on the handheld.

## Checking Available Memory

Complete the following steps to view the amount of memory (in bytes) used by all documents and variables on your handheld.

1. From the Home screen, select **Status** from the **Settings** menu.

Press **(up arrow)** **(5)** **(4)**.

The Handheld Status window opens.

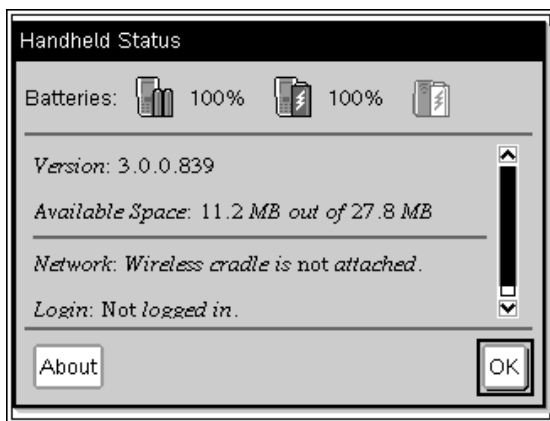

2. View the *Available Space* field to determine how much memory is available on the handheld.
3. Click **OK** to return to the Home screen.

## Freeing Memory

To free or recover memory, delete documents and/or folders from the handheld. To keep the documents and folders for later use, transfer them to another handheld or to a computer using the TI-Nspire™ software.

### Deleting Files from the Handheld

1. Press **(on)** **(2)** to open the **My Documents** file browser.
2. Press **▲** or **▼** to select the folder or document you want to delete.
3. Press **(del)**.

–or–

Press **(ctrl)** **(menu)** **(6)**.

A dialogue box opens, asking you to confirm the deletion.

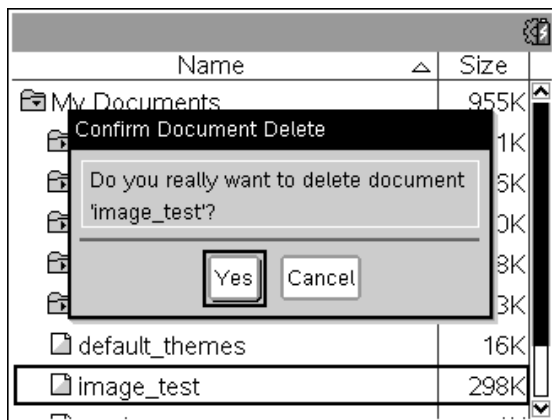

4. Press **(enter)** to confirm or **(esc)** to cancel.

The folder/document is permanently removed from the handheld.

### Backing up Files to Another Handheld

1. Connect the two handhelds using the USB-to-USB connectivity cable.
2. Press **(on)** **(2)** to open **My Documents** on the sending handheld.
3. Press the **▲** and **▼** keys to highlight the document you want to send.
4. Press **(menu)**, and then select Send.

–or–

Press **(ctrl)** **(menu)** **(2)**.

- When the file transfer is complete, a message is displayed on the receiving handheld.

## Transferring Files to a Computer

Use the TI-Nspire™ software to transfer files and folders from a handheld to a computer.

- Connect your handheld to the computer using a standard A to mini-B USB cable.
- In the TI-Nspire™ software, open the Documents Workspace.
- In the Documents Toolbox, click  to open the Content Explorer.



Computer pane

Connected  
Handhelds pane

- In the Computer pane, navigate to the folder in which you want to save the files.
- In the Connected Handhelds pane, double-click the handheld name to view the folders and files on the handheld.

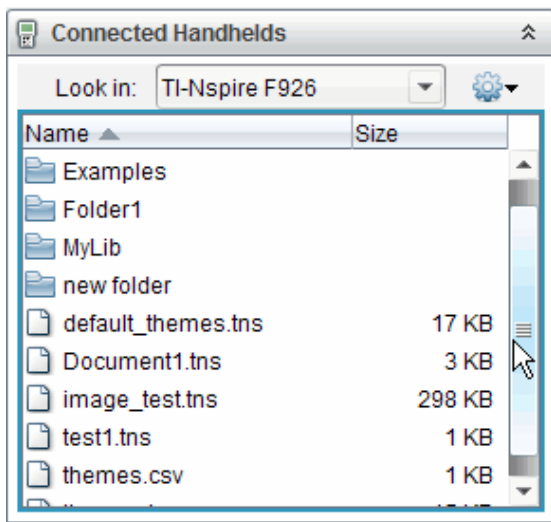

- Select the file or folder you want to save to the computer.
  - Click the file to select one file or folder at a time.
  - To select all files on the handheld, select the first file in the list, hold down the **Shift** key, and then click the last file or folder in the list.
  - To select random files, click the first file, and then hold the **Ctrl** key while selecting additional files.

**Note:** If you select multiple files, it is saved as lesson bundle (.tilb file).

- Drag the files to the folder in the Computer pane.

–or–

Select **File > Save as**.

The files are copied to the folder on the computer.

- Verify that the files you need are available on your computer, and then delete the files from the handheld.



**Note:** Those using the TI-Nspire™ Teacher Software or the TI-Nspire™ Navigator™ Teacher Software can also use options in the Content Workspace to copy files from a handheld to a computer.

## Resetting the Memory

Complete these steps only if you want to delete ALL files and folders on your handheld.

**Caution:** Before you reset all memory, consider restoring sufficient available memory by deleting only selected data. If you reset all memory, the pre-installed applications on your handheld will remain, but any applications that have been downloaded in TI-84 mode will be deleted.

1. After making certain you want to clear all files, press **(on)** **(2)** to open the **My Documents** file browser.
2. Press **(menu)** to open the context menu.
3. Select **Delete All**.

–or–

Press **(C)**.

The Data Loss dialogue box opens.

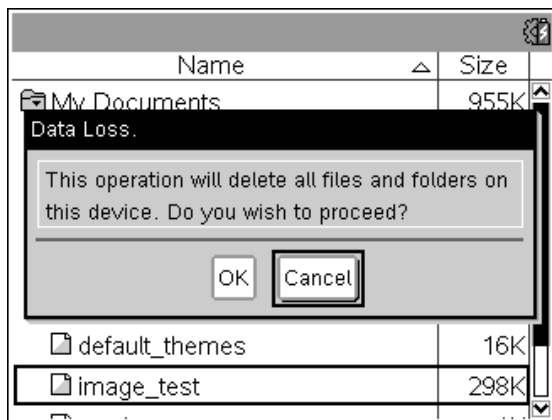

4. Click **OK** to confirm that you want to clear the handheld memory.



# Updating the Handheld Operating System

To take advantage of the latest handheld features and updates, download the latest operating system files from the Education Technology website ([education.ti.com](http://education.ti.com)). You can update the operating system (OS) on TI-Nspire™ handhelds using a computer and the following software:

- TI-Nspire™ Teacher Software
- TI-Nspire™ Student Software
- TI-Nspire™ CAS Teacher Software
- TI-Nspire™ CAS Student Software
- TI-Nspire™ Navigator™ Teacher Software
- TI-Nspire™ CAS Navigator™ Teacher Software

In the classroom, you can use the TI-Nspire™ Docking Stations to upgrade the OS on multiple handhelds at the same time.

You can also transfer the OS from one TI-Nspire™ handheld to another or from one TI-Nspire™ CX handheld to another. However, handheld operating systems are not interchangeable. You cannot transfer a CAS operating system to a non-CAS handheld and you cannot transfer a TI-Nspire™ handheld operating system to a TI-Nspire™ CX handheld.



## *What You Need to Know*

- If there is not enough room on the receiving handheld for the upgrade, a message is displayed. For more information, See *Memory and File Management*.
- OS upgrade operations do not delete user documents. The only time documents are affected by an OS installation is if the receiving handheld has a corrupted OS. In this situation, documents may be affected by OS restoration. It is a good practice to back up important documents and folders before installing an updated operating system.

**Warning:** Upgrading the operating system will delete all TI-84 applications and files. Before installing an OS upgrade, you should use TI Connect to back up all TI-84 applications and files to a computer. You can copy them back to the handheld when the OS upgrade is complete.

## ***Before You Begin***

Before beginning an OS download, ensure that batteries are at least 25 percent charged.

- To check the status of the rechargeable battery in TI-Nspire™ CX handhelds, press  **5** **4** to open the **Handheld Status** dialogue box.
- To check the status of both the rechargeable battery and the AAA batteries in TI-Nspire™ handhelds, press  **5** **4** to open the **Handheld Status** dialogue box.

When in OS download mode, the Automatic Power Down™ (APD™) feature does not function. If you leave your handheld in download mode for an extended time before you begin the downloading process, your batteries may become depleted. You will then need to replace or recharge the batteries before downloading the OS.

## ***Finding Operating System Upgrades***

For up-to-date information about available OS upgrades, check the Texas Instruments website at <http://education.ti.com>.

You can download an OS upgrade from the Texas Instruments website to a computer and use a USB cable to install the OS on your TI-Nspire™ handheld. You will need an Internet connection and the appropriate USB cable to download the updates.

## **Checking for Handheld OS Updates**

When using TI-Nspire™ software, you can quickly determine if your handheld OS is up to date when the handheld is connected to a computer.

1. Open the TI-Nspire™ software and ensure the handheld is connected to your computer.
2. In the Documents Workspace, click  to open Content Explorer.
3. In the Connected Handhelds pane, select a connected handheld.

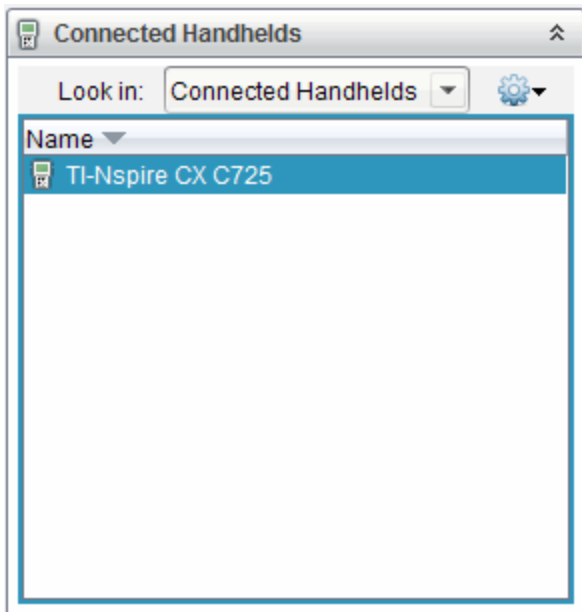

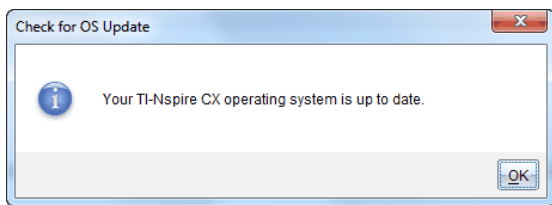

4. Select **Help > Check for Handheld/Lab Cradle OS Update**.
  - If the operating system is current, the Check for Handheld OS Update dialogue box opens indicating that the operating system on the handheld is up to date.



- If the operating system is not current, the dialogue box contains a message indicating that a new version of the operating system is available.
5. To turn off automatic notifications, clear the "Automatically check for updates" checkbox. By default, this option is turned on.
  6. Click **OK** to close the dialogue box.

## Upgrading the Operating System

In the TI-Nspire™ software, you can select to upgrade the operating system on a connected handheld from the following workspaces and menus:

- In all versions of the software, you can select **Help > Check for Handheld/Lab Cradle OS Update**. Select a connected handheld in the Content Explorer to activate this option. If the OS on the handheld is not current, the dialogue box indicates that there is an updated version of the operating system. Follow the prompts to update the operating system.
- In all versions of the TI-Nspire™ software, you can use options available in the Documents Workspace:
  - Open Content Explorer, select the handheld name, and then click  and select **Install OS**.  
–or–
  - Select **Tools > Install Handheld/Lab Cradle OS**.
- Those using teacher versions of the TI-Nspire™ software can use options available in the Content Workspace:
  - In the Resources pane, right-click the name of a connected handheld, and then select **Install Handheld/Lab Cradle OS**.  
–or–
  - Select the handheld name in the Preview pane, click  in the Preview pane, and then select **Install Handheld/Lab Cradle OS**.  
–or–
  - Right-click the handheld name and select **Install Handheld/Lab Cradle OS**.

## Completing the OS Upgrade

When you select to update the OS on a handheld, the Select Handheld OS File dialogue box opens.

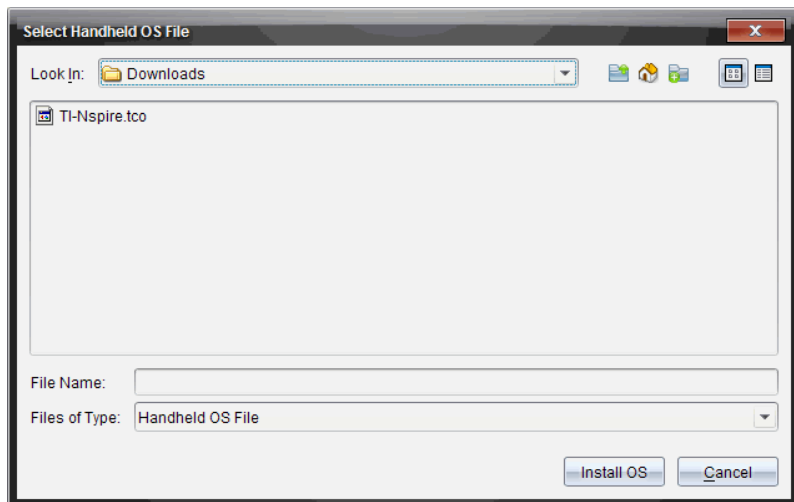

The file displayed for selection defaults to the file type required for the selected handheld.

1. Select the OS file:
  - If you are upgrading a TI-Nspire™ CX handheld, select TI-Nspire.tco
  - If you are upgrading a TI-Nspire™ CX CAS handheld, select TI-Nspire.tcc
  - If you are upgrading a TI-Nspire™ handheld, select TI-Nspire.tno
  - If you are upgrading a TI-Nspire™ CAS handheld, select TI-Nspire.tnc
2. Click **Install OS** to download the OS and update the handheld. The confirmation message “*You are about to upgrade your handheld operating system. Any unsaved data will be lost. Do you want to continue?*” is displayed.
3. Click **Yes** to continue.

The Installing OS dialogue box opens indicating the progress of the download. Do not disconnect the handheld.

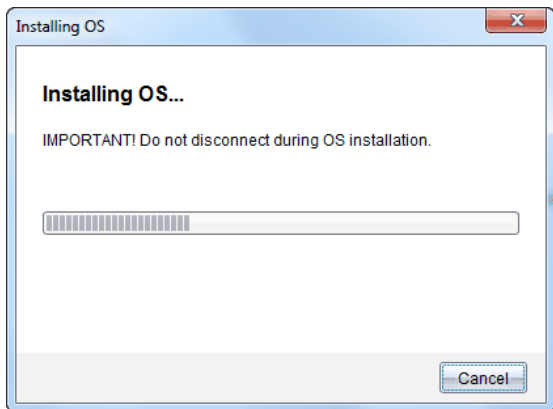

4. When the download is complete, the Information dialogue box opens indicating that the OS file has been successfully transferred to the handheld. You can disconnect the handheld.

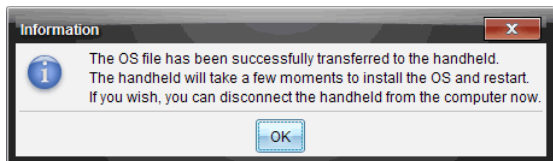

5. Click **OK**.

The updated operating system is installed on the handheld. When the update is complete, the handheld reboots.

6. On the handheld, follow the prompts to:
  - Choose a preferred language.
  - Select a preferred font size.

7. When the Welcome screen opens, click **OK**.

The Home screen opens.

## Transferring the Operating System From Another Handheld

**Note:** You cannot transfer the OS on a TI-Nspire™ handheld to a TI-Nspire™ CX handheld and you cannot transfer the OS on a CAS handheld to a non-CAS handheld. The operating systems are not the same and are not interchangeable.

To transfer the OS from one handheld to another:



1. Ensure any open documents on the receiving handheld are closed.
2. Connect the two handhelds using a USB mini-B to mini-B USB cable.
3. On the sending handheld, select My Documents from the Home screen.
4. Press **[menu]**, and then select **Send OS**.  
On a TI-Nspire™ handheld, press **[menu]**.

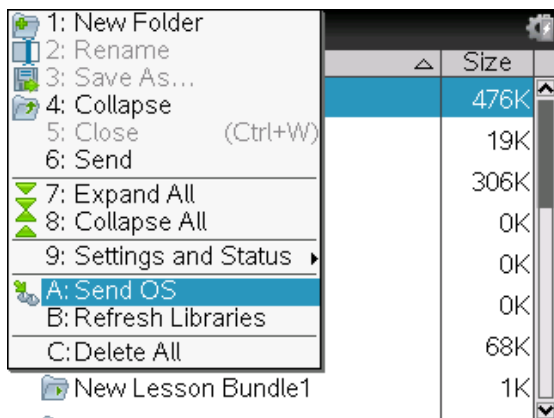

5. On the receiving handheld, the message, “*You are receiving an OS Upgrade. Unsaved changes will be lost. Would you like to continue?*” is displayed along with Yes and No response buttons. Select Yes to receive the OS upgrade.
  - If **Yes** is not selected within 30 seconds, the handheld automatically responds with No and the transmission is cancelled.
  - It is important to save and close all open documents before performing an OS Upgrade. Continuing with an OS Upgrade on a handheld with an open, unsaved document will cause the loss of that data.
6. While the upgrade is in progress, the following messages are displayed on the receiving and sending handhelds:
  - “*Receiving OS. Do not unplug cable.*”
  - “*Sending OS. Do not unplug cable.*”
7. After the transfer completes, the sending handheld receives a completion message and you can unhook the cable. The OS is automatically installed on the receiving handheld. During the installation process, the “*Installing OS <version number>*” message is displayed on the receiving handheld.

8. When the installation is complete, the “OS <version number> has been installed. Handheld will now restart.” message is displayed. The restart is initiated. If the sending handheld is still attached to the cable, the successful transmission message remains displayed on that handheld’s screen.

**Important:**

- For each receiving handheld, remember to back up information as necessary and install new batteries.
- Be sure the sending handheld is on the **Send OS** screen.

### ***Upgrading the OS on Multiple Handhelds***

In the classroom, use the TI-Nspire™ Docking Station to upgrade the OS on multiple handhelds at the same time.

In the teacher versions of the TI-Nspire™ software, you can transfer files from the computer to multiple handhelds from the Content Workspace. See *Using the Content Workspace* for more information about transferring files to connected handhelds.

### ***OS Upgrade Messages***

This section lists the information and error messages that can be displayed on handhelds during an OS Upgrade.

<b>Shown on:</b>	<b>Message and Description</b>
Sending handheld	<p style="text-align: center;">"Receiver does not have enough storage space. Make &lt;xxxK&gt; available."</p>
	<p>This message indicates that the receiving handheld does not have enough memory available for the new OS. The space requirement is shown so you know how much memory must be cleared for the new operating system. Files can be moved to a computer for storage to free the necessary space.</p>
Sending handheld	<p style="text-align: center;">"Receiver must change batteries before upgrading the OS."</p>

Shown on:	Message and Description
	This message indicates that the batteries in the receiving handheld need to be replaced. Send the OS Upgrade once the batteries are replaced.
Sending handheld	<p style="text-align: center;">"Receiver has a newer OS and cannot load this OS." OK</p>
	This message indicates that the receiving handheld has a newer OS version than the one being transmitted. You cannot downgrade an OS.
Sending handheld	<p style="text-align: center;">"Upgrade not accepted by receiver." OK</p>
	This message indicates that the receiving handheld refuses the upgrade.
Sending handheld	<p style="text-align: center;">"OS has been transferred. You can now unplug." OK</p>
	This message indicates that the transfer is complete and it is safe to unplug the cable from the sending handheld.
Sending handheld	<p style="text-align: center;">"Sending OS. Do not unplug cable."</p>
	This message, along with a progress bar, is displayed while the OS Upgrade is being transferred.
Both handhelds	<p style="text-align: center;">"Transfer failed. Check cable and try again." OK</p>
	The sending and/or receiving handheld is not properly connected. Reinsert the cable into each handheld, and then try the transmission again.

Shown on:	Message and Description
Receiving handheld	<p style="text-align: center;">"You are receiving an OS Upgrade. Unsaved changes will be lost. Would you like to continue?" Yes No</p>
	<p>This message is displayed when an OS Upgrade is about to begin. If you do not select Yes within 30 seconds, the system automatically responds with No.</p>
Receiving handheld	<p style="text-align: center;">"Receiving OS. Do not unplug cable."</p>
	<p>This message, along with a progress bar, is displayed while the OS Upgrade is being transferred.</p>
Receiving handheld	<p style="text-align: center;">"Installing OS."</p>
	<p>This message is displayed when the transfer is complete. It is shown to keep you informed of the handheld's status.</p>
Receiving handheld	<p style="text-align: center;">"OS has been installed. Handheld will restart." OK</p>
	<p>This information message displays briefly before the handheld automatically reboots.</p>
Receiving handheld	<p style="text-align: center;">"Install was corrupted. Handheld will reboot. You will need to retry OS upgrade." OK</p>
	<p>An error occurred during the transmission and the installation was corrupted. The handheld will reboot. After the reboot, reinstall the OS Upgrade.</p>

## Working in TI-84 Mode

**Note:** The TI-Nspire™ CAS handheld does not operate in TI-84 mode. If the handheld is a CAS version, please disregard all references to operation in the TI-84 mode.

### Understanding Dual-Mode Operation

The TI-Nspire™ handheld works with two keypads:

- The TI-Nspire™ keypad
- The TI-84 Plus keypad



TI-84 Plus keypad (on left) and TI-Nspire™ keypad (on the handheld)

### *Changing the Keypad*

**Caution:** When changing keypads, be certain that the handheld is completely powered down before removing the keypad. Removing the keypad before the display clears may result in loss of data.

1. Remove the cover and turn the handheld over. Slide the latch release to the right. The keypad releases.

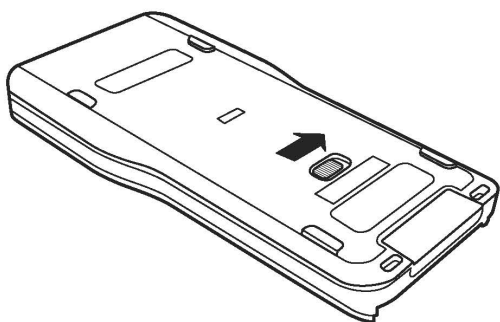

2. Turn the handheld top side up and slide the keypad away from the display screen.

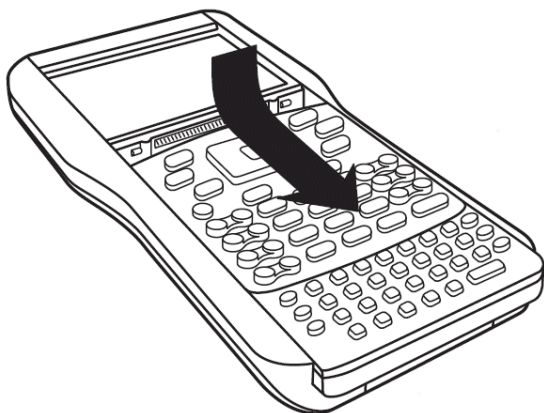

3. Lift the keypad off the handheld.

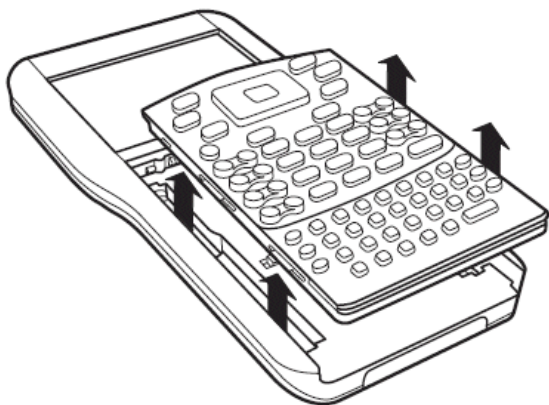

4. Insert the other keypad.

Ensure that it fits comfortably into the guides on the bottom and sides of the handheld.

**Note:** The keypad does not slide in from the bottom edge of the handheld. Instead, fit it into the guides just above the batteries.

5. When the keypad is properly seated on the handheld, push the keypad toward the display screen.

The keypad clicks into place when properly seated and completely inserted into the handheld.

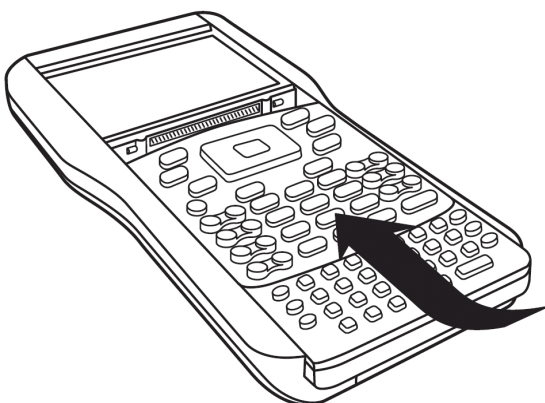
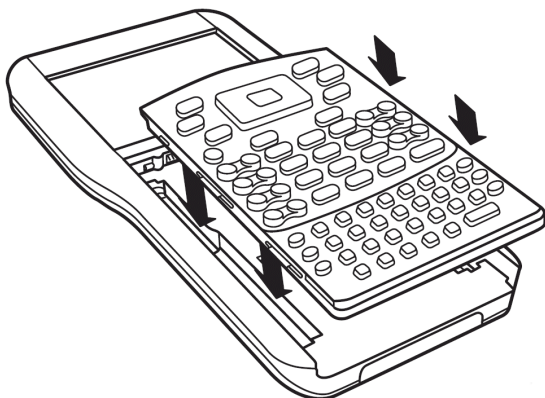

## ***TI-84 Plus Mode Cables***

If you already have TI-84 Plus handhelds and use the I/O port for connectivity, use the same cables to connect to a TI-Nspire™ handheld using the TI-84 keypad.

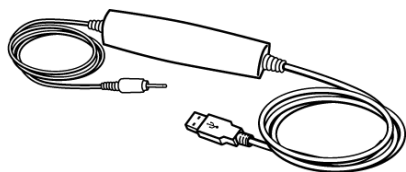

USB connection cable to connect handheld in TI-84 mode to a computer using TI-Connect software.

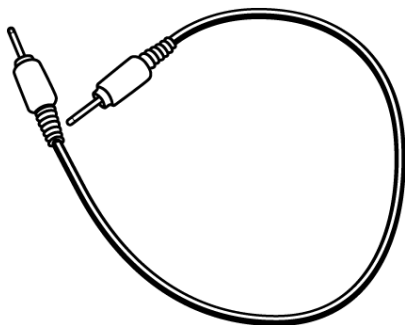

TI-84 Plus I/O handheld-to-handheld connection cable

## Connecting a TI-Nspire™ with TI-84 Plus Keypad to a TI-84 Plus Handheld

The TI-Nspire™ TI-84 Plus keypad I/O link port is located at the bottom edge of the keypad. The TI-84 Plus I/O link port is located at the top left edge of the graphing calculator.

1. Firmly insert either end of the I/O cable into the port.
2. Insert the other end of the cable into the other handheld's I/O port.



## Capturing Screens in TI-84 Mode

To capture screens when using a TI-Nspire™ TI-84 Plus handheld, you must use TI Connect™ Software. TI Connect™ Software is available for both Windows® and Mac® systems and includes options for capturing screen images, transferring files and updating operating systems. For more information about TI Connect™ Software, visit the [education.ti.com](http://education.ti.com) website.

## Upgrading the TI-84 Plus OS

To update the operating system on a TI-84 Plus handheld using TI-Nspire™ software, switch to the TI-Nspire™ faceplate and install the latest OS available



from TI.

# Texas Instruments Support and Service

Home Page:	<a href="http://education.ti.com">education.ti.com</a>
E-mail inquiries:	<a href="mailto:ti-cares@ti.com">ti-cares@ti.com</a>
KnowledgeBase and e-mail inquiries:	<a href="http://education.ti.com/support">education.ti.com/support</a>
International information:	<a href="http://education.ti.com/international">education.ti.com/international</a>

## ***Service and Warranty Information***

For information about the length and terms of the warranty or about product service, refer to the warranty statement enclosed with this product or contact your local Texas Instruments retailer/distributor.

## ***Precautions for Rechargeable Batteries***

Take these precautions when replacing rechargeable batteries:

- Use only the charger recommended for the cell or battery, or the one that was provided with the original equipment.
- Remove the cell or battery from the charger or alternating current adapter when not in use or being charged.
- Use of the battery in other devices may result in personal injury or damage to equipment or property.
- Do not mix brands (or types within brands) of batteries. There is a risk of explosion if a battery is replaced by the wrong type.

## **Disposing of Batteries**

Do not mutilate, puncture, or dispose of batteries in fire. The batteries can burst or explode, releasing hazardous chemicals. Discard used batteries according to local regulations.

# Index

## A

AAA batteries .....	9
installing .....	77
replacing .....	79
About CAS .....	7
adding	
accents to text .....	68
applications .....	44
multiple applications to pages .....	46
pages to problems .....	58
problems .....	58
adjusting contrast .....	13
APD™ .....	9
Application icons .....	14
applications	
adding to documents .....	44
Calculator .....	14
Data & Statistics .....	14
Geometry .....	14
Graphs .....	14
images .....	69
Lists & Spreadsheet .....	14
multiple on pages .....	46
Notes .....	14
swapping .....	49
Vernier DataQuest .....	14
arrow keys .....	11
Automatic Power Down™ .....	9
available memory .....	109

## B

backup	
handheld files to another handheld .....	110
batteries	
AAA .....	9
disposing of .....	84
installing .....	77
rechargeable .....	9, 80
replacing .....	79
TI-Nspire/TM Rechargeable Battery .....	80
battery status .....	83
browsing files .....	60

## C

cables .....	99
TI-84 Plus Mode .....	127
Calculate .....	13
Calculator .....	14
Calculator history	
clearing .....	30
copying items from .....	30
results .....	31
viewing .....	30
cancelling a file transfer .....	103
Capturing screens in TI-84 mode .....	128
CAS .....	7
CAS handhelds .....	7
Catalogue	
inserting commands .....	65
inserting items from .....	27
opening .....	64
wizards .....	66
changing	
Graphs & Geometry Settings .....	92

characters	
international language .....	68
special .....	66
Checking battery status .....	83
Choosing a font size .....	10
class	
logging in .....	73
closing	
documents .....	64
Scratchpad .....	24
communication hardware .....	96
Computer Algebra System (CAS) .....	7
computer touchpad .....	11
connecting	
two handhelds .....	100
contrast	
adjusting .....	13
copying	
documents .....	63
folders .....	63
copying images .....	69
creating	
documents .....	42
folders .....	62
customising	
General Settings .....	87
Graphs & Geometry Settings .....	92

## D

Data & Statistics .....	14
images .....	69
default settings	
changing General Settings .....	89
restoring General Settings .....	91

deleting	
documents .....	62
folders .....	62
deleting files .....	110
deleting images .....	71
disposing of batteries .....	84
documents	
closing .....	64
copying .....	63
copying pages to .....	56
creating .....	42
deleting .....	62, 110
managing .....	59
navigating .....	59
receiving from another user .....	102
renaming .....	61
saving .....	42
selecting for transfer .....	102
structure .....	41
transferring .....	101

## E

editing	
maths expressions .....	32
errors	
sending folders .....	105
evaluating	
maths expressions .....	24, 27
expressions	
copying from Calculator history .....	31
editing .....	32
entering and evaluating .....	24
entering from a template .....	27
entering with a wizard .....	27
selecting in Calculator .....	32

## F

file transfers	
common error messages .....	106
files	
backing up .....	110
deleting .....	110
naming conventions .....	62
transferring .....	101
transferring to a computer .....	111
transferring to another handheld .....	101
finding upgrades .....	116
first time use .....	9
folders	
copying .....	63
creating .....	62
deleting .....	62
naming conventions .....	62
renaming .....	61
font	
choosing .....	10
size .....	10
Freeing memory .....	110

## G

General Settings	
customising .....	87
restoring .....	91
Geometry .....	14
Graph .....	13
Graphs .....	14
Graphs & Geometry	
images .....	69
Graphs & Geometry Settings	
changing .....	92

customising .....	92
viewing .....	92

## H

### handheld

adjusting contrast .....	13
connecting to a TI-84 .....	128
connecting to another .....	100
first time use .....	9
hints .....	16
home menu .....	15
home screen .....	12
keys .....	7
screen .....	15
turning on for the first time .....	9
updating the operating system .....	115

### hardware

communication .....	96
---------------------	----

hints .....	16
-------------	----

history, Calculator .....	31
---------------------------	----

home screen .....	12
-------------------	----

options .....	12
---------------	----

Home screen .....	11
-------------------	----

Home screen options .....	13
---------------------------	----

## I

### icons

application .....	14
-------------------	----

### images

copying .....	69
---------------	----

Data & Statistics .....	69
-------------------------	----

deleting .....	71
----------------	----

Graphs & Geometry .....	69
-------------------------	----

Notes .....	69
-------------	----



on a handheld .....	69
Question .....	69
Quick Poll .....	69
repositioning .....	70
resizing .....	71
selecting .....	69
TI-Nspire™ applications .....	69
inserting	
expression templates .....	25
functions and commands .....	25
items from Catalogue .....	25
symbols .....	25
units .....	25
international language characters .....	68

## K

keypad .....	7
changing .....	125

## L

language	
changing .....	85
choosing .....	9
international characters .....	68
Lists & Spreadsheet .....	14
logging in to class .....	73

## M

maths expressions .....	67
editing .....	32
entering and evaluating .....	24
selecting in Calculator .....	32
maths templates .....	66

memory	
checking .....	109
recovering .....	110
resetting .....	113
menus	
context .....	51
mouse pointer .....	12
My Documents .....	13, 60

## N

naming files and folders .....	62
New Document .....	13
Notes .....	14
images .....	69

## O

opening	
Catalogue .....	25, 64
context menus .....	51
My Documents .....	60
Scratchpad .....	23
opening the Settings menu .....	85
operating system	
updating .....	115
Operating System	
transferring .....	120
upgrading .....	118
operating system upgrades .....	116
Operating System upgrades	
error messages .....	122
options	
Home screen .....	12-13
OS	
transferring .....	120

upgrading .....	118
OS upgrades	
error messages .....	122

## P

page layouts	
choosing .....	46
custom .....	47
page sorter .....	54, 59
pages .....	41
adding to problems .....	58
copying to another document .....	56
copying to another problem .....	55
reordering .....	53, 59
reordering in problems .....	54-56
power sources .....	84
preferred language .....	9, 85
Preparing the handheld for use .....	9
priority of power sources .....	84
problems .....	41
adding pages .....	58
adding to pages .....	52
copying .....	57
copying pages to other problems .....	55
deleting .....	58
pasting .....	57
renaming .....	58
reordering .....	54

## Q

Question	
images .....	69
Quick Poll	
images .....	69

## R

receiving	
documents from another user .....	102
rechargeable battery .....	9
recharging	
handhelds .....	83
TI-Nspire/TM Rechargeable Battery .....	83
recovering deleted documents .....	63
recovering memory .....	110
removing images .....	71
renaming	
documents .....	61
folders .....	61
problems .....	58
repositioning images, moving images .....	70
resetting memory .....	113
resizing images .....	71
restoring	
General Settings .....	91
reusing	
items from Calculator history .....	31

## S

saving	
documents .....	42
Scratchpad contents .....	38
Scratchpad .....	13, 15
Calculate .....	13
Graph .....	13
selecting	
expressions in Calculator .....	32
selecting a language .....	9
selecting images .....	69
Selecting options .....	12

sending folder errors .....	105
Settings .....	13
Settings & Status	
General Settings .....	87
Graphs & Geometry .....	92
Settings menu .....	85
software	
upgrading .....	74

## T

templates .....	27, 66
maths expressions .....	67
TI-84	
connecting to a TI-Nspire™ handheld .....	128
power options .....	87
TI-84 mode	
capturing screens .....	128
TI-84 Plus keypad .....	125
TI-84 Plus Mode cables .....	127
TI-Nspire™ applications	
images .....	69
TI-Nspire™ handhelds .....	7
TI-Nspire™ Navigator™ wireless cradle	
attaching to handheld .....	96
TI-Nspire™ Rechargeable Battery .....	9
touchpad	
using .....	11
transferring	
documents to another handheld .....	101
files to another handheld .....	101
transferring files .....	101
rules .....	101
Transferring files to a computer .....	111
transfers	
cancelling .....	103

## U

Understanding the Scratchpad .....	15
Upgrading the OS .....	118
USB cables .....	99
using the touchpad .....	11
Using USB cables .....	99

## V

variables .....	64
Vernier DataQuest .....	14
viewing	
Calculator history .....	30
Graphs & Geometry Settings .....	92

## W

Welcome! screen .....	10
wireless communication hardware .....	96
wireless cradle	
connecting to handheld .....	96
wizards .....	27, 66
work areas .....	41, 46