

TI-89 / TI-92 Plus / Voyage™ 200 Symbolic Math Guide

Getting Started

- Navigating
- Creating Problem Sets
- Memory Requirements
- Solving Problems

How To...

- Create a Problem Set
- Solve Problems
- Select a Sub-Expression
- Back-Substitute
- Define a Function
- Rewrite an Expression
- Substitute a Variable

FAQs

- Domain of Definition
- [F4] Menu Transformations
- Basic Integrals
- Time to Think Mode
- Basic Derivatives

More Information

- Shortcuts
- Customer Support
- Keystroke Differences



Important Information

Texas Instruments makes no warranty, either express or implied, including but not limited to any implied warranties of merchantability and fitness for a particular purpose, regarding any programs or book materials and makes such materials available solely on an "as-is" basis.

In no event shall Texas Instruments be liable to anyone for special, collateral, incidental, or consequential damages in connection with or arising out of the purchase or use of these materials, and the sole and exclusive liability of Texas Instruments, regardless of the form of action, shall not exceed the purchase price of this product. Moreover, Texas Instruments shall not be liable for any claim of any kind whatsoever against the use of these materials by any other party.

Graphing product applications (Apps) are licensed. See the terms of the [license agreement](#) for this product.

Microsoft, Windows, Windows NT, Apple, and Macintosh are trademarks of their respective owners.

What is Symbolic Math Guide?

Symbolic Math Guide is a software application that is part of TI's ongoing research aimed at helping students learn how to apply symbolic and algebraic transformations using the TI-89, TI-92 Plus, and Voyage™ 200.

Because it is more faithful to the mathematics and mathematical notation found in textbooks than other calculator-based computer algebra systems (CAS), Symbolic Math Guide makes it easier for students to relate to the mathematics in their textbooks.

Symbolic Math Guide provides step-by-step problem-solving transformations for several classes of symbolic computations from algebra, pre-calculus, and calculus, including the following:

Simplify	Monomials	Logarithmic & exponential expressions
	Polynomials	Trigonometric expressions
	Rational expressions	Difference quotients
	Radical expressions	Generic expressions
Expand	Logarithmic & exponential expressions	Trigonometric equations
		Generic expressions
Solve	Linear equations	Radical equations
	Quadratic equations	Logarithmic & exponential equations
	Rational equations	Generic expressions
Compute	Derivatives	Indefinite integrals
Other	Axioms & Laws	Factor
	Identity	

Symbolic Math Guide performs all operations in strict REAL mode. It treats non-real sub-expressions, $+\infty$, and $-\infty$ as undefined. Symbolic Math Guide provides the corresponding domain of definition for which the original expression is real and finite. It also generates domain preservation constraints whenever a selected transformation would otherwise change the domain of definition. Symbolic Math Guide attempts to produce solutions consisting of equivalent expressions or of equivalent equations.

What's Different in Version 2.00?

New features:

- Indefinite Integration, Axioms & Laws, and Factor and Identity problem types
- Generic problem types, Simplify Expression, Expand Expression, and Solve Equation
- SHOW CONSTRAINTS mode
- A problem set can be saved as a TEXT Var or a FLIO NoteFolio AppVar in addition to a SMPS AppVar

Improvements:

- Improved the user interface for $\boxed{F4}$ Trans menu, for derivative transformations, for the Substitute dialog box, and for Verify Solution
- Added and modified a number of transformations
- Added Apply (transformation) and Discriminant to the $\boxed{F5}$ Tools menu

What You Will Need

To install and run Symbolic Math Guide, you need:

Hardware and software	Notes
TI-89, TI-92 Plus or Voyage™ 200 graphing handheld with version 2.08 or later of the Advanced Mathematics operating system software	You can download a free copy of the latest operating system software from education.ti.com/latest .
Computer with Microsoft® Windows® 98/2000, Windows NT®, or Apple® Macintosh® OS 7.1 or higher installed	
TI Connectivity computer-to-device cable	TI Connectivity cables are available for purchase from retail stores, online retailers, and instructional dealers. See a list at education.ti.com/buy . You may also purchase TI Connectivity cables from the TI online store at education.ti.com/shop .
TI Connect™ software, which works with most supported models of Flash-based TI graphing devices	You can download free copies of TI Connect software from education.ti.com/downloadticonnect .

Where to Find Installation Instructions

Detailed instructions on installing this and other applications are available at education.ti.com/guides. Follow the link to Flash installation instructions.

























































Getting Help

The instructions in this guidebook are only for this application. If you need help using the TI-89, TI-92 Plus, or Voyage™ 200 graphing handheld, refer to its comprehensive guidebook at education.ti.com/guides.

Keystroke Differences

There are certain differences in keystrokes using the TI-89 / TI-92 Plus/Voyage™ 200 graphing handheld for various operations. The following table shows the keystrokes for major commands for the two calculators.

Function	TI-89	TI-92 Plus / Voyage 200
LETTERS		
One lowercase letter (a-s, u, v, w)	$\boxed{\text{alpha}}$ A-S, U-W	A-S, U-W
One lowercase letter (t, x, y, z)	T, X, Y, Z	T, X, Y, Z
Several lowercase letters	$\boxed{2\text{nd}}$ [a-lock]	
End several lowercase letters	$\boxed{\text{alpha}}$	
Several uppercase letters	$\boxed{\uparrow}$ [a-lock]	$\boxed{2\text{nd}}$ [CAPS]
End several uppercase letters	$\boxed{\text{alpha}}$	$\boxed{2\text{nd}}$ [CAPS]
FUNCTION KEYS		
F6	$\boxed{2\text{nd}}$ [F6]	$\boxed{\text{F6}}$
F7	$\boxed{2\text{nd}}$ [F7]	$\boxed{\text{F7}}$
F8	$\boxed{2\text{nd}}$ [F8]	$\boxed{\text{F8}}$

Function	TI-89	TI-92 Plus / Voyage 200
NAVIGATION		
Scroll tall objects up or down	  ,  	  ,  
Move cursor far left or far	  ,  	  ,  
Diagonal movement	 and   and   and   and 	       
FUNCTIONS		
Display Home screen		 [HOME]
Cut	 [CUT]	 X
Copy	 [COPY]	 C
Paste	 [PASTE]	 V
Catalog		 [CATALOG]
Display Units dialog box	 [UNITS]	 [UNITS]
Sin	 [SIN]	
Cos	 [COS]	
Tan	 [TAN]	
LN	 [LN]	
e^x	 [e^x]	 [e^x]
EE		 [EE]

Function	TI-89	TI-92 Plus / Voyage 200
SYMBOLS		
_ (Underscore)	\diamond [-]	$\boxed{2nd}$ [-]
θ (Theta)	\diamond [θ]	$\boxed{\theta}$
(“With”)	\boxed{I}	$\boxed{2nd}$ [I]
' (Prime)	$\boxed{2nd}$ [']	$\boxed{2nd}$ [']
° (Degree)	$\boxed{2nd}$ [°]	$\boxed{2nd}$ [°]
\angle (Angle)	$\boxed{2nd}$ [\angle]	$\boxed{2nd}$ [\angle]
Σ (Sigma)	$\boxed{CATALOG}$ Σ ($\boxed{2nd}$ [Σ]
x^{-1} (Reciprocal)	$\boxed{CATALOG}$ \wedge^{-1}	$\boxed{2nd}$ [x^{-1}]
Space	\boxed{alpha} [-]	Space bar
HIDDEN SHORTCUTS		
Place data in sysdata	\diamond ,	\diamond D
Greek characters	\diamond (\boxed{alpha} or \diamond	\diamond G or \diamond G $\boxed{\uparrow}$
Keyboard map	\diamond \boxed{EE}	\diamond [KEY]
Place data in Home screen	\diamond (-)	\diamond H
Grave (à, è, ì, ò, ù)	$\boxed{2nd}$ [CHAR] 5	$\boxed{2nd}$ A a, e, i, o, u
Cedilla (ç)	$\boxed{2nd}$ [CHAR] 5 6	$\boxed{2nd}$ C c
Acute (á, é, í, ó, ú, ý)	$\boxed{2nd}$ [CHAR] 5	$\boxed{2nd}$ E a, e, i, o,
Tilde (ã, ñ, õ)	$\boxed{2nd}$ [CHAR] 5 6	$\boxed{2nd}$ N a, n, o

Function	TI-89	TI-92 Plus / Voyage 200
Caret (â, ê, î, ô, û)	$\boxed{2nd}$ [CHAR] 5	$\boxed{2nd}$ O a, e, i, o, u
Umlaut (ä, ë, ï, ö, ü, ÿ)	$\boxed{2nd}$ [CHAR] 5	$\boxed{2nd}$ U a, e, i, o,
? (Question mark)	$\boxed{2nd}$ [CHAR] 3	$\boxed{2nd}$ Q
β (Beta)	$\boxed{2nd}$ [CHAR] 5 6	$\boxed{2nd}$ S
# (Indirection)	$\boxed{2nd}$ [CHAR] 3	$\boxed{2nd}$ T
& (Append)	$\boxed{\blacklozenge}$ $\boxed{\times}$ (times)	$\boxed{2nd}$ H
@ (Arbitrary)	$\boxed{\blacklozenge}$ $\boxed{STO\blacktriangleright}$	$\boxed{2nd}$ R
≠ (Not equal to symbol)	$\boxed{\blacklozenge}$ $\boxed{=}$	$\boxed{2nd}$ V
! (Factorial)	$\boxed{\blacklozenge}$ $\boxed{\div}$	$\boxed{2nd}$ W
Comment (Circle-C)	$\boxed{\blacklozenge}$ $\boxed{)}$ \bullet	$\boxed{2nd}$ X \bullet
New	$\boxed{F1}$ 3	$\boxed{\blacklozenge}$ N
Open	$\boxed{F1}$ 1	$\boxed{\blacklozenge}$ O
Save copy as	$\boxed{F1}$ 2	$\boxed{\blacklozenge}$ S
Format dialog box	$\boxed{\blacklozenge}$ \boxed{I}	$\boxed{\blacklozenge}$ F

Memory Requirements

Symbolic Math Guide requires that at least 5000 bytes RAM be free and that a sufficient number of unused memory blocks in RAM be available while the application is running. If these memory requirements are not met, an error message displays and the application closes automatically.

The following table shows memory error messages and what to do if you receive them.

Error message	Recovery
Memory Error You must free up some RAM memory or open a new problem set.	The amount of free RAM has dropped below 5000 bytes. You can do one of the following: <ul style="list-style-type: none">• Delete some user variables, programs, lists, etc. to free some RAM.• Open a new problem set
Memory Error You must delete some user variables or open a new problem set.	The number of available memory blocks in RAM is too low. You can do one of the following: <ul style="list-style-type: none">• Delete some user variables.• Open a new problem set

Starting and Quitting Symbolic Math Guide

Note

The current version of Symbolic Math Guide runs best when the language mode is set to English. To change the language mode, press **MODE** **F3**, and then press \odot to highlight the language. Press \odot to display a list of languages on your calculator, and then select English. Press **ENTER** to save the change.

Starting Symbolic Math Guide

1. With the Apps desktop turned on, press **APPS** to display the desktop, highlight **Symbolic Math Guide**, and press **ENTER**.
– or –
With the Apps desktop turned off, press \blacklozenge **APPS**, highlight **Symbolic Math Guide**, and press **ENTER**.
2. Select the type of file to open:
Current opens the problem set you worked with most recently
Open opens an existing problem set
New creates a new problem set
3. Select or specify the folder name and variable name for the problem set.
4. Press **ENTER**.

Quitting Symbolic Math Guide

- From any screen, press $\boxed{2\text{nd}} \boxed{[\text{QUIT}]}$
- You can temporarily leave Symbolic Math Guide by pressing $\boxed{[\text{HOME}]}$. To return to the Symbolic Math Guide, press $\boxed{2\text{nd}} \boxed{[\text{+}]} \boxed{[\text{+}]}$.

Getting Started

Note

This user guide shows TI-92 Plus/Voyage™ 200 graphing handheld keystrokes. There are some keystroke differences between the TI-89, TI-92 Plus/Voyage 200. Please refer to [Keystroke Differences](#) for more information on these differences.

Creating Problem Sets

Work through this exercise to become familiar with creating problem sets in Symbolic Math Guide. In this exercise, you create a problem set that contains four problems.

► Start the application, and then create a new problem set:

1. With the Apps desktop turned on, press **[APPS]** to display the desktop, highlight **Symbolic Math Guide**, and press **[ENTER]**.
– or –
With the Apps **desktop turned off**, press **[◆] [APPS]**, highlight **Symbolic Math Guide**, and press **[ENTER]**.
2. Select **New...** to create a new problem set.
3. Move the cursor to the Variable field, and then type an unused name (such as demo1) for the problem set.
4. Press **[ENTER] [ENTER]**.

► Add the first problem, $3x + 1 = x - 2$, to the problem set:

1. Press **[F2]** **1: New Problem...**
2. Press **[F3]** **1: Linear Eqn.**
3. Type the equation, adding **,x** to complete the solve() command, and then press **[ENTER]**.



► Add the second problem, $y^2 \cdot y^3$:

1. Press **F2** **1: New Problem...**
2. Press **F1** **1: Monomial**.
3. Type the expression, and then press **ENTER**.

Tip To enter $y^2 \cdot y^3$, press the following keys: **Y** **^** **2** ***** **Y** **^** **3**.

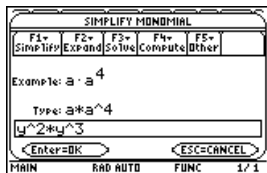

► Add the third problem, $c \cdot x + 3 = 6$:

1. Press **[F2] 1: New Problem...**
2. Press **[F3] 1: Linear Eqn.**
3. Type the equation, and then press **[ENTER]**.

Tip To enter $c \cdot x$, you must type **C [X] X**, not CX.

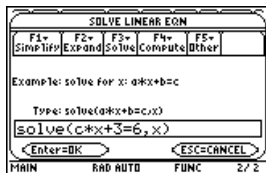

► Add the fourth problem, $\frac{d}{dx} \cos(x^4)$:

1. Press **[F2] 1: New Problem...**
2. Press **[F4] 1: Derivative.**
3. Type the expression, and then press **[ENTER]**.

Tip

To enter $\frac{d}{dx} \cos(x^4)$, press the following keys: **[2nd] [COS] X [^] 4 [D]**

[,] X [ENTER].



Solving Problems

Work through this exercise to become familiar with solving problems using Symbolic Math Guide. In this exercise, you open a problem set that you either downloaded from the online store (*tourps.9xy* or *tourps.89y*), or entered manually as described in the previous section, and solve those problems.

To follow the steps in this exercise, Symbolic Math Guide's TIME TO THINK mode must be off and SHOW CONSTRAINTS mode must be on.

- TIME TO THINK mode displays the transformations you choose on the screen so that you can think about what happens when you apply them before you see the result. It is initially turned off.
- SHOW CONSTRAINTS mode allows you to display the domain constraints for a problem. It is initially turned on.

You can turn either mode on or off by pressing **[F1] 9: Format**, and then selecting **ON** or **OFF** for the mode.

Tip

When you use the TIME TO THINK mode:

- To apply the transformation currently displayed, press **[ENTER]**.
- To choose a different transformation, press **[ESC]** to clear the current transformation, and then press **[F4]** to select another transformation.

► Start the application and open the problem set.

1. With the Apps desktop turned on, press **[APPS]** to display the desktop, highlight **Symbolic Math Guide**, and press **[ENTER]**.

– or –

With the Apps desktop turned off, press **◆ [APPS]**, highlight **Symbolic Math Guide**, and press **[ENTER]**.

2. Select **Open**, and then press **[ENTER]**. The OPEN dialog box is displayed.

3. Press **⏴** to highlight the Variable field, and then press **⏵** to display a list of problem sets on your calculator.

4. Select the problem set name (either **tourps** that you downloaded or the name of the problem set that you created in the previous section), and then press **[ENTER]**.

5. Press **[ENTER]** again to display the Symbolic Math Guide main screen. Problem 1 is displayed.

► Solve problem 1, linear equation $3x + 1 = x - 2$:

1. Think about what it means to solve the problem. You can press **F7 1: Goal** to display the goal for solving the problem. (Press **ENTER** to clear the Goal window.)

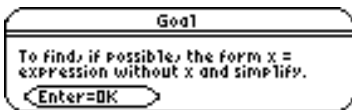

2. Press **F4** to display a list of possible transformations that you can apply to the problem. Do you see the transformation you want to apply?
3. An appropriate choice is to subtract x from each side so that only the left side depends on x . Select **subtract ? from each side**. A dialog box is displayed so that you can specify the value to subtract from each side.
4. Type x and then press **ENTER**.

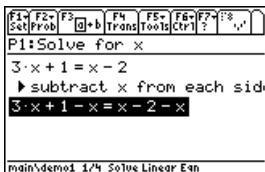

5. Press **ENTER** to simplify both sides of the equation.

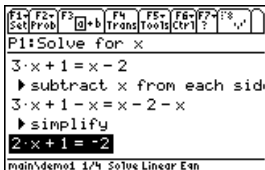

6. Press **F4** to display the transformations menu, and then select another transformation to apply.
7. An appropriate choice is to subtract 1 from both sides so that there is no constant term on the left side. Select **subtract ? from each side**. A dialog box is displayed so that you can specify the value to subtract from each side.
8. Press **1**, and then press **ENTER**.

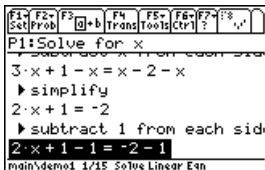

9. Press **ENTER** to simplify the equation.

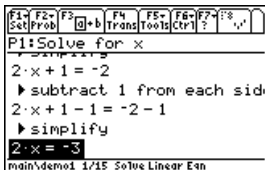

10. Press **F4** to display the transformations menu, and then select another transformation to apply.
11. An appropriate choice is to divide both sides by 2 so that the left side becomes x. Select **divide each side by ?**. A dialog box is displayed so that you can specify the value to divide by.
12. Press **2**, and then press

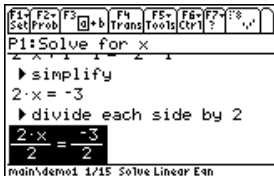

13. Press **ENTER** to simplify both sides of the equation.

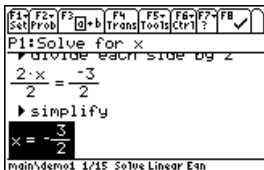

► Solve problem 2, simplify $y^2 \cdot y^3$:

1. Press **F6** 1: **Next Problem**.

2. Think about what it means to solve the problem.

3. Press **F4** to display a list of possible transformations that you can apply to the problem. Do you see the transformation you want to apply?

4. Select $A^U \cdot A^V \rightarrow A^{(U+V)}$ and then press **ENTER**.

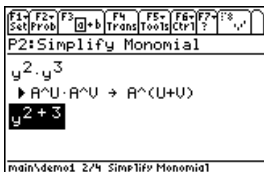

5. Press **ENTER** to perform the arithmetic.

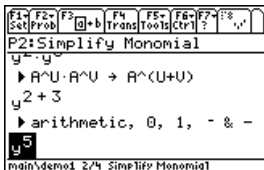

- Solve problem 3, linear equation $c \cdot x + 3 = 6$:

1. Press **F6** **1: Next Problem**.
2. Think about what it means to solve the problem.
3. Press **F4** to display a list of possible transformations that you can apply to the problem. Do you see the transformation you want to apply?
4. Select **subtract ? from each side**. A dialog box is displayed so that you can specify what value to subtract.
5. Press **3**, and then press **ENTER**.

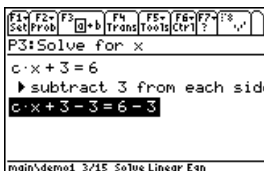

6. Press **ENTER** to simplify the equation.

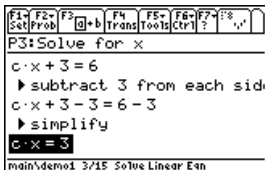

7. Press **F4**, and then select the next transformation: **divide each side by?**. A dialog box is displayed so that you can specify what value to divide by.
8. Input **C** and then press **ENTER**. A warning is displayed to remind you that the constraint $c \neq 0$ will be added to the problem, which might reduce the domain of definition.

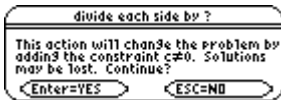

9. Press **ENTER** to continue and apply the transformation.

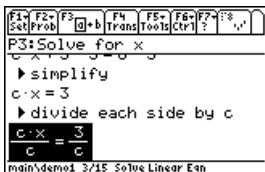

10. Press **ENTER** to simplify the equation.

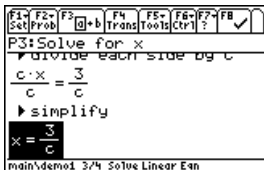

11. Press **F8** to verify the solution.

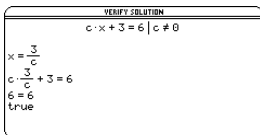

12. Press **ENTER** to return to the problem.

► Solve problem 4, compute derivative $\frac{d}{dx}(\cos(x^4))$:

1. Press **F6** **1: Next Problem**.

2. Think about what it means to solve the problem.

3. Press **F4** to display a list of possible transformations that you can apply to the problem. Do you see the transformation you want to apply?

Note Most of the time, Symbolic Math Guide will not allow you to

choose transformations that cannot be performed. For Compute Derivative problems and Compute Indefinite Integral, $\boxed{F4}$ displays transformations that may not be useful for completing the problem.

4. Select **derivative of composition**. A dialog box is displayed so that you can input values for $f(u)$ and $u = g(x)$.

To fill in the values automatically, press $F1$.

5. Press $\boxed{\text{ENTER}}$ $\boxed{\text{ENTER}}$ to apply the transformation.

6. Press $\boxed{F4}$, and then select the next appropriate transformation: $\frac{d}{dx}(x^r) \rightarrow r \cdot x^{r-1}$.

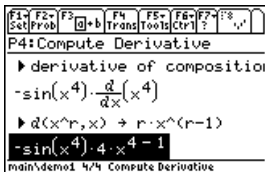

7. Press **ENTER** to simplify the expression.

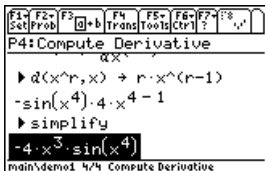

Now that you have learned how to solve problems, you can read further to learn more about other Symbolic Math Guide features. For example, you can

- [Select a part of an expression](#)
- [Define a function](#)
- [Substitute a variable for a sub-expression](#)
- [Rewrite an expression](#)

Creating Problem Sets

Note

This user guide shows Voyage™ 200 graphing handheld keystrokes. There are some keystroke differences between the TI-89 and the Voyage™ 200. Please refer to [Keystroke Differences](#) for more information on these differences.

When you create a problem set, you have a blank screen to enter individual problems. In an existing problem set, you can add, delete, or edit problems. Students open the problem set and then work through the problems step by step, getting help and hints along the way.

Tip

If you don't have sufficient RAM, you might not be able to save your problem set in its entirety. Before you create a new problem set, check the amount of available memory ($\boxed{2\text{nd}} \text{ [MEM]}$). You can also check the sizes of other problem sets ($\boxed{2\text{nd}} \text{ [VAR-LINK]}$). Problem sets are limited to 50 problems, but that number may be too many to save if you don't have enough free RAM. Also, keep in mind that users generally prefer problem set that have a maximum of 25-30 problems.

1. Press $\boxed{\text{F1}}$ **1: New Problem Set**.
2. Select the folder where you want to store the problem set, enter a name for the problem set in the Variable field, and then press $\boxed{\text{ENTER}}$.

- Press **[F2]** **1: New Problem**. The New Problem screen is displayed. (If the problem set already contains problems, the problem type for the previous problem is displayed.)
- Press a function key (**[F1]**-**[F5]**) to select a problem type. The corresponding menu shows the problem types in that category.
- Select a problem type. An example is displayed, as well as the keystrokes you would use to create that example.

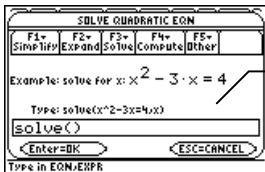

The SOLVE QUADRATIC EQN. Screen (**[F3]** 2: Quadratic Eqn.)

Note

It is important to choose the most appropriate problem type, because the available transformations might depend upon the type.

- Type the problem.
- Press **[ENTER]**.

The F2 menu gives you the following options to use to create the problem set:

Use this F2 menu option...	To do this...
New Problem	Create a new problem and add it to the end of the problem set.
Edit Problem	Change the problem that is currently displayed.
Insert Problem	Create a new problem and place it before the current problem in the problem set.
Cut Problem	Delete a problem so that you can paste it to a new location.
Copy Problem	Copy a problem so that you can paste it to a new location.
Paste Problem	Pastes a copied problem into the problem set before the currently displayed problem.
Delete Problems	Delete a problem without storing it to the clipboard.

Navigating within a Problem Set

There are two ways to move from problem to problem within a problem set: use the navigation bar or the F5 menu.

Navigating Using the Navigation Bar

The problem number and the problem type are always displayed at the top of the screen. When you move the cursor to the problem number, the line becomes a navigation bar. Press \leftarrow or \rightarrow to display a different problem.

\leftarrow displays the previous problem in the problem set.

\leftarrow or \rightarrow displays the first problem in the problem set.

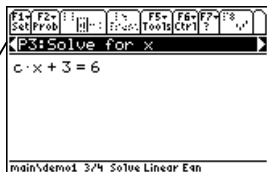

\rightarrow displays the next problem in the problem set.

\rightarrow or \rightarrow displays the last problem in the

Navigating Using the F6 Menu

The F6 menu gives you options to go to the next problem, the previous problem, or a specific problem in the problem set.

Use this F6 menu option...

To do this...

Next Problem

Display the next problem in the problem set.

Use this F6 menu option...

To do this...

Previous Problem

Display the previous problem in the problem set.

Go To Problem

Display a specific problem in the problem set (e.g., problem 10). Type the problem number, then press **ENTER**.

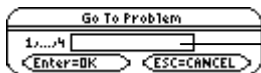

Type the problem number and press **ENTER** to display a specific problem.

Learning with Problem Sets

Note

This user guide shows TI-92 Plus graphing handheld keystrokes. There are some keystroke differences between the TI-89 and the TI-92 Plus. Please refer to [Keystroke Differences](#) for more information on these differences.

1. Start the application and select a problem set. (See [Starting and Quitting Symbolic Math Guide](#) if you need more information.)
2. Select a problem to solve.

Applying Transformations to Equations

When you solve a problem, you apply a series of transformations to it until you reach an answer. Think of the transformations as the separate steps you take to reach the answer.

Consider the following example:

Problem

Solve for x :

$$x^2 - 4 = 0$$

Manual Solution

1. Add 4 to both sides of the equation:
 $x^2 - 4 + 4 = 0 + 4$
which simplifies to $x^2 = 4$
2. Extract the square roots.
 $\sqrt{x^2} = \sqrt{4}$
 $x = \sqrt{4}$ and $x = -\sqrt{4}$
3. Simplify the equations:
 $x = 2$ and $x = -2$
4. Verify solution.

Symbolic Math Guide takes you through each of these steps. Let's look at the same problem solved using Symbolic Math Guide:

1. If you don't know what it means to solve the equation, you can press **F7** and select **Goal** to display the goal for the problem.

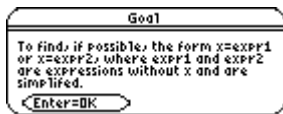

2. Press **[F4]** to display some transformations that might apply to this problem type.

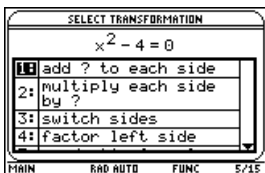

3. Select a transformation. For this problem, select **add ? to each side**.

Note

For solving equations, most transformations that are displayed are applicable. However, many of them might be unwise choices because if they are applied, the problem is no closer to a solution.

4. Enter the value **4** to add to each side.

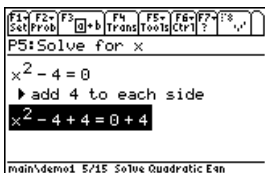

5. Press **[ENTER]** to simplify both sides of the equation.
6. Now, you must select the next transformation to perform. Press **[F4]** to display the list of transformations.

7. Select the next transformation to perform ($A^2=B \rightarrow A=\sqrt{B}$ or $A=-\sqrt{B}$).



8. Press **ENTER** to simplify the equation.

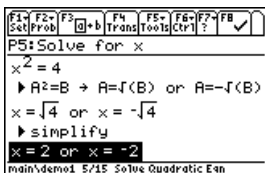

9. Press **F8** to verify the solution.

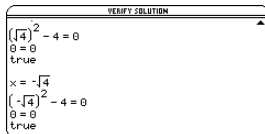
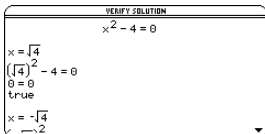

10. Press **ENTER** to return to the problem.

Selecting Part of an Expression

You can select a smaller part of an expression and perform transformations on it using the sub-expression selection tool ($\boxed{F3}$). Sometimes you must do this because $\boxed{F4}$ offers some transformations only if they are applicable to the entire expression or to a selected sub-expression.

You use the arrow keys and $\boxed{2nd}$ plus the arrow keys to select a sub-expression. It helps to understand the tree structure of the expression so that you know which arrow keys to press to select the sub-expression that you want. The following examples show expressions with their tree structures, including parent nodes, children nodes, and leaf nodes.

- A parent node is an expression.
- Children nodes are smaller sub-expressions that make up the parent node.
- Leaf nodes are either numbers or variables and have no children.

Expression

Tree Structure

For $a + b$:

- $a + b$ is the parent node of a and b .
- a and b are children nodes of $a + b$.
- a and b are leaf nodes.

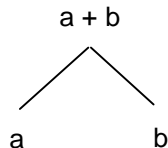

For $a - b$:

- $a - b$ is the parent node of a and $-b$.
- a and $-b$ are children nodes of $a - b$.
- $-b$ is the parent node of b .
- a and b are leaf nodes.

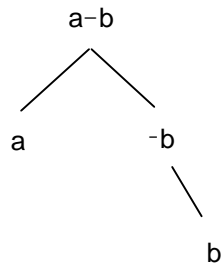

For $a \cdot b$:

- $a \cdot b$ is the parent node of a and b .
- a and b are children nodes of $a \cdot b$.
- a and b are leaf nodes.

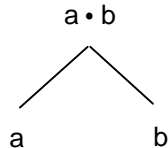

For $\frac{a}{b}$:

- $\frac{a}{b}$ is the parent node of **a** and **b**.
- **a** and **b** are the children nodes of $\frac{a}{b}$.
- **a** and **b** are leaf nodes.

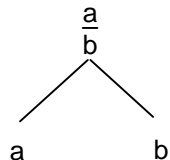

For a^b :

- a^b is the parent node of **a** and **b**.
- **a** and **b** are the children nodes of a^b .
- **a** and **b** are leaf nodes.

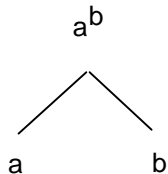

For $\sin(a)$:

- $\sin(a)$ is the parent node of **a**.
- **a** is the child node of $\sin(a)$.
- **a** is a leaf node.



Expression**Tree Structure**

For $a + b - c + d$:

- $a + b - c + d$ is the parent node of a , b , c , and d .
- a , b , $-c$, and d , are the children nodes of $a + b - c + d$.
- $-c$ is the parent node of c .
- a , b , c , and d are leaf nodes.

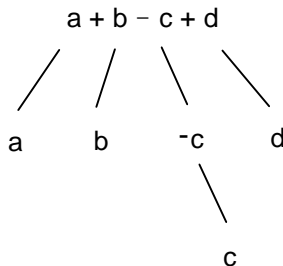

For $a + b = c + d$:

- $a + b = c + d$ is the parent node of $a + b$ and $c + d$.
- $a + b$ and $c + d$ are the children nodes of $a + b = c + d$.
- $a + b$ is the parent node of a and b .
- $c + d$ is the parent node of c and d .
- a , b , c , and d are leaf nodes.

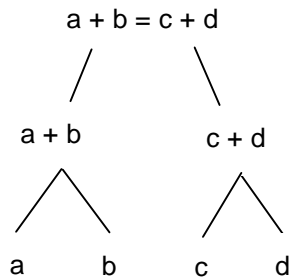

► To enter sub-expression selection mode, press **F3**.



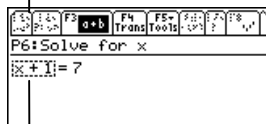

The F3 menu icon changes to indicate that sub-expression selection mode is active.





The problem is displayed in reverse video in scrolling mode, and with a dotted outline in sub-expression selection mode.

► To select a parent or a child node:

- Press \odot to select the parent of the selected expression.
- Press \ominus to select a child of the selected expression.

Initial selection	Key pressed	New selection
 <p>P6: Solve for x $x + 1 = 7$</p>	\odot	 <p>P6: Solve for x $x + 1 = 7$</p>
 <p>P6: Solve for x $x + 1 = 7$</p>	\ominus	 <p>P6: Solve for x $x + 1 = 7$</p>

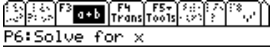
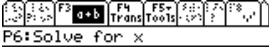
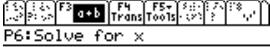
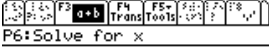
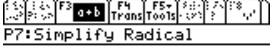
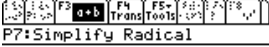
- To select a sibling node (another child node when a child node is currently selected), press \odot or \ominus .

Initial selection	Key pressed	New selection
 <p>P6:Solve for x</p> $x + 1 = 7$ <p>_____ x + 1 is the parent node of x</p>	\odot	 <p>P6:Solve for x</p> $x + 1 = 7$
 <p>P6:Solve for x</p> $x + 1 = 7$ <p>_____ x + 1 is the parent node of 1</p>	\ominus	 <p>P6:Solve for x</p> $x + 1 = 7$
 <p>P7:Simplify Radical</p> $\sqrt{\frac{16 \cdot x^2}{3 \cdot x}}$ <p>_____ $\frac{16 \cdot x^2}{3 \cdot x}$ is the parent node of $16 \cdot x^2$.</p>	\odot	 <p>P7:Simplify Radical</p> $\sqrt{\frac{16 \cdot x^2}{3 \cdot x}}$
 <p>P7:Simplify Radical</p> $\sqrt{\frac{16 \cdot x^2}{3 \cdot x}}$ <p>_____ $\frac{16 \cdot x^2}{3 \cdot x}$ is the parent node of $3 \cdot x$.</p>	\ominus	 <p>P7:Simplify Radical</p> $\sqrt{\frac{16 \cdot x^2}{3 \cdot x}}$

- ▶ To select an adjacent sibling node (select both the currently selected child node and an adjacent child node), press $\boxed{\uparrow}$ \odot or $\boxed{\uparrow}$ \odot .

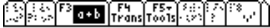
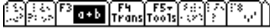
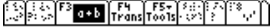
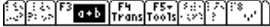

Initial selection	Keys pressed	New selection
 P8:Simplify Polynomial $a + \boxed{b} + c$ $a + b + c$ is the parent node of b	$\boxed{\uparrow}$ \odot	 P8:Simplify Polynomial $a + \boxed{b + c}$
 P8:Simplify Polynomial $a + \boxed{b + c}$ $a + b + c$ is the parent node of b	$\boxed{\uparrow}$ \odot	 P8:Simplify Polynomial $\boxed{a + b + c}$

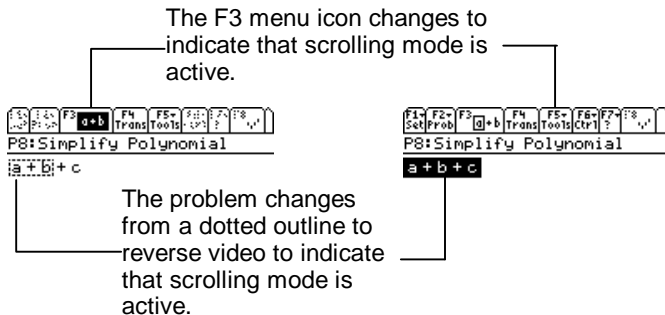
- ▶ To exit sub-expression selection mode, press $\boxed{F3}$ or \boxed{ESC} .

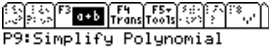

Shortcuts

- Press $\boxed{2nd}$ \odot to select the rightmost child node of the current parent node.
- Press $\boxed{2nd}$ \odot to select the leftmost child node of the current parent node.
- Press $\boxed{2nd}$ \odot to select the leftmost leaf of the selected expression.
- Press $\boxed{2nd}$ \odot to select the entire expression.

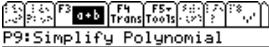
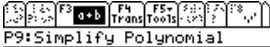
Initial selection	Keys pressed	New selection
 $\frac{x^{k+1} + 3x + 4}{x^2 - 5}$	$\boxed{2nd}$ \odot	 $\frac{x^{k+1} + 3x + 4}{x^2 - 5}$
<p>$x^{k+1} + 3x + 4$ is the parent node of x^{k+1}.</p>		
 $\frac{x^{k+1} + 3x + 4}{x^2 - 5}$	$\boxed{2nd}$ \odot	 $\frac{x^{k+1} + 3x + 4}{x^2 - 5}$
<p>$x^{k+1} + 3x + 4$ is the parent node of 4.</p>		

Initial selection

Keys pressed

New selection



P9:Simplify Polynomial

$$\frac{x^k + 1 + 3 \cdot x + 4}{x^2 - 5}$$

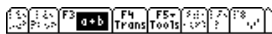
2nd \downarrow 

P9:Simplify Polynomial

$$\frac{x^k + 1 + 3 \cdot x + 4}{x^2 - 5}$$

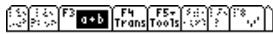

P9:Simplify Polynomial

$$\frac{x^k + 1}{x^2 - 5} + 3 \cdot x + 4$$

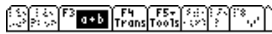
2nd \uparrow 

P9:Simplify Polynomial

$$\frac{x^k + 1}{x^2 - 5} + 3 \cdot x + 4$$

► Compute the derivative $\frac{d}{dx}(\sin(x^2) \cdot \cos(x))$:

1. [Create the problem](#) in your problem set.
2. Press **F4** to display possible transformations.

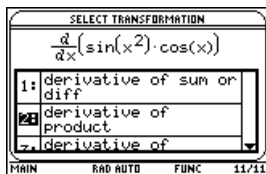

3. Select **derivative of product**. A dialog box is displayed so that you can input values for $f(x)$ and $g(x)$.

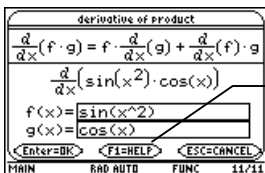

To fill in the values automatically, press F1.

4. Press **ENTER** **ENTER** to apply the transformation.
5. Press **F3** to change to sub-expression selection mode.

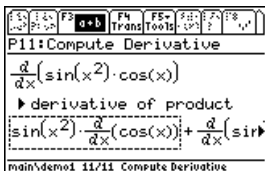

6. Press **→** **↵** to select $\frac{d}{dx}(\sin(x^2))$.

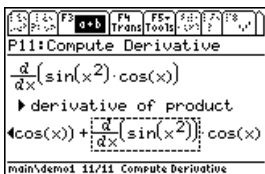

7. Press **F4** to display possible transformations.

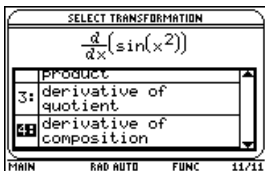

8. Select **derivative of composition**. A dialog box is displayed so that you can input values for $f(u)$ and u .

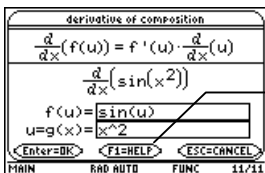

To fill in the values automatically, press F1.

9. Press **ENTER** **ENTER** to apply the transformation.

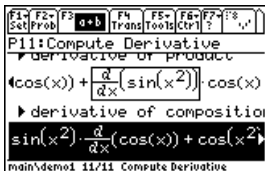

10. Press **F4** to display possible transformations.

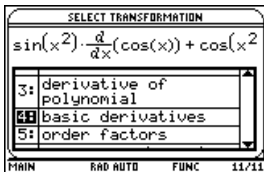

11. Select **basic derivatives**, and then press **ENTER**.

12. Press **ENTER** again to simplify the derivative.



Defining a Function

Symbolic Math Guide lets you simplify expressions and solve equations that contain functions. You can also define the function, if you want to. When you create a problem that contains a function, a dialog box is displayed that lets you define the function.

► Simplify the difference quotient $\frac{f(x+h)-f(x)}{h}$ for $f(x) = \sqrt{x}$:

1. Press **[F2] 1: New Problem.**
2. Press **[F1] 7: Difference Quotient.**
3. Enter the problem: $\text{avgRC}(f(x),x,h)$, and then press **[ENTER]**.
The Define dialog box is displayed.

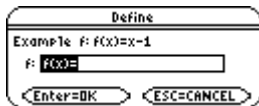

4. Enter the definition $f(x)=\sqrt{x}$, and then press **ENTER**.

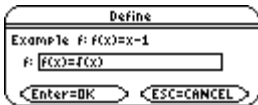

Tip

To change a function definition:

1. Press **F2** and select **Edit Problem**.
2. Press **ENTER** to display the Define dialog box.
3. Make your changes and press **ENTER** to save them.

Substituting, Back-substituting, Rewriting, and Verifying the Solutions of Equations

Symbolic Math Guide lets you transform expressions in several ways that make it easier for you to solve problems:

- Substituting – You can substitute a variable for an expression or sub-expression to represent it more concisely.
- Back-substituting – You can substitute the original sub-expression back into the problem to complete a solution.
- Rewriting – You can rewrite an expression in a form that is easier for you to operate upon.
- Verifying – After you have solved an expression, you can verify the solution.

Substituting a Variable for an Expression

- Solve the exponential equation $(2^x)^2 + 2 \cdot 2^x - 3 = 0$.

You can make a substitution to make this equation easier to solve.

1. Press **F5** **4: Substitute** to display the Substitute dialog box.
2. Enter the variable that you want to substitute in the Substitute field (for example, **u**).
3. Enter the expression that the variable replaces in the next field and the new expression in the last field.

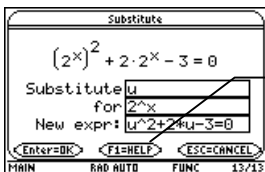

To fill in the values automatically, press **F1**.

4. Press **ENTER** **ENTER** to complete the substitution.

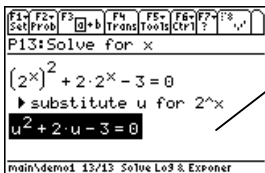

The resulting equation, $u^2 + 2u - 3 = 0$ is a quadratic equation in standard form. When you solve this equation, you find that $u = 1$ or $u = -3$.

Back-Substituting into the Equation

When you make a substitution in a problem, you need to substitute the original expression back into the problem so that you can solve the original problem.

► In the previous example, you found that $u = 1$ or $u = -3$, but in the original problem, $(2^x)^2 + 2 \cdot 2^x - 3 = 0$, you needed to solve for x . To solve for x , back-substitute $u = 2^x$ into the original problem:

1. Press **[F5]** **5: Back Substitute**. The Back Substitute dialog box is displayed, showing the substitutions you made in the problem.

Note

If you made more than one substitution, press \odot or \ominus to select the back-substitution you want and press **[ENTER]** to select it.

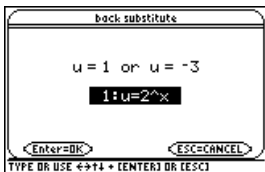

2. Press **[ENTER]** to make the back-substitution.

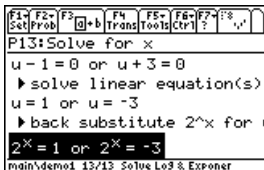

Rewriting and Expression and Verifying the Solution of an Equation

You can use the Verify Solution option on the F8 menu to check your solution.

▶ Continuing from the previous section, solve the exponential equation $(2^x)^2 + 2 \cdot 2^x - 3 = 0$, and then verify the solution:

1. Use [sub-expression selection](#) to select $2x = -3$.
2. Press **[F4]** to display possible transformations.
3. Select **negative=nonneg** → **false** and press **[ENTER]**.

4. Press **ENTER** to simplify.

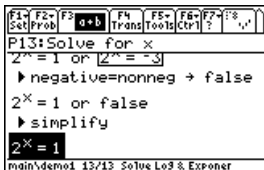

5. Use [sub-expression selection](#) to select 1.
6. Press **F5 3: Rewrite**. The Rewrite As dialog box is displayed.
7. Enter $2^{\mathbf{A0}}$ to rewrite 1 as 2^0 and press **ENTER**.
8. Press **F4** to display possible transformations.
9. Select $\mathbf{A^U=A^V} \rightarrow \mathbf{U=V}$ and press **ENTER**.

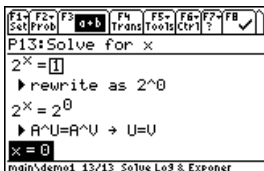

10. Press **F8** to verify the solution.

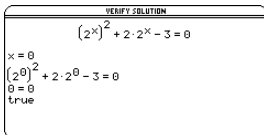

Domain of Definition and Domain Preservation Constraints

The following examples show how to display the domain of definition for a problem, and how Symbolic Math Guide applies domain preservation constraints.

In the first example, the original expression, $\frac{x^2}{x}$, is undefined at

$x = 0$; therefore, it has a domain of definition of $x \neq 0$. However, $\frac{x^2}{x}$

simplifies to the expression x , which has an apparent domain of definition which includes $x = 0$. When you apply **divide like factors**,

$\frac{x^2}{x}$ is transformed into $x \mid x \neq 0$. The solution indicates that the

constraint $x \neq 0$ still applies. The transformation constrained the apparent domain of definition of the expression x .

► Simplify the rational expression $\frac{x^2}{x}$:

1. Press **F5** **1:Info** and then select **3: Domain** to display the domain constraints for this expression.



2. Press **ENTER** to exit the information screen.
3. Press **F4** to display possible transformations.
4. Select **divide like factors** and press **ENTER**.
5. Press **ENTER** again to apply the transformation. The solution is displayed.

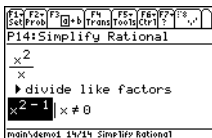

In the next example, the transformation **divide like factors** simplifies the expression $\frac{x}{x^2}$ into $\frac{1}{x}$ without any indication of domain because both the original expression and the simplified expression have the same domain of definition, $x \neq 0$.

► Simplify the rational expression $\frac{x}{x^2}$:



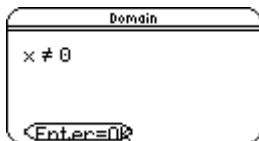



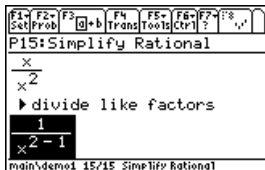













1. Press **F5** **1:Info** and then select **3: Domain** to display the domain constraints for this expression.



2. Press **ENTER** to exit the information screen.
3. Press **F4** to display possible transformations.
4. Select **divide like factors** and press **ENTER**.
5. Press **ENTER** again to apply the transformation. The solution is displayed.



Shortcuts – Scrolling Mode

Keystrokes	Description	Problem Types
  or  	Displays the last problem in the problem set, with the problem statement highlighted	All
  or  	Displays the first problem in the problem set, with the problem statement highlighted	All
  or  	Moves the cursor to the first math object	All
  or  	Moves the cursor to the last math object	All
 	Moves the cursor to the top of the problem	All
 	Moves the cursor to the bottom of the problem	All

Keystrokes	Description	Problem Types
ENTER	<p>TIME TO THINK:</p> <p>Applies the selected transformation</p> <p>In normal mode:</p> <ul style="list-style-type: none"> Performs arithmetic and the 0 & 1 identities on simplify problems problem type Simplifies the expression 	<p>All</p> <p>Simplify expression (all)</p> <p>Solve equations (all), compute derivatives, compute indefinite integrals, and identity</p>
S	Substitutes a variable for an expression	All
B	Back-substitutes an expression for a variable	All
◆ ENTER	Approximates the solution	All
V	Verifies the solution	All
+	When an expression is selected, applies the following transformation: add $0=?-?$ to the expression	All

Keystrokes	Description	Problem Types
×	When an expression is selected, applies the following transformation: multiply the expression by $1=?/?$	All
	When an expression is selected, applies the following transformation: rewrite expression as ?	All
+	When an equation is selected, applies the following transformation: add ? to each side	
-	When an equation is selected, applies the following transformation: subtract ? to each side	
×	When an equation is selected, applies the following transformation: multiply each side by ?	All
÷	When an equation is selected, applies the following transformation: divide each side by ?	All

Keystrokes	Description	Problem Types
$\boxed{\text{LN}}$	When an equation is selected, applies the following transformation: apply ln to each side	All
$\boxed{\wedge}$	When an equation is selected, applies the following transformation: raise both sides to ? power	All
$\boxed{2\text{nd}} \boxed{\sqrt{\quad}}$	When an equation is selected, applies the following transformation: take square root of each side	All

Shortcuts – Sub-expression Selection Mode

Keystrokes	Description
$\boxed{2\text{nd}}$ \odot	Selects the rightmost child node of the current parent node
$\boxed{2\text{nd}}$ \ominus	Selects the leftmost child node of the current parent node
$\boxed{2\text{nd}}$ \downarrow	Selects the leftmost leaf of the selected expression
$\boxed{2\text{nd}}$ \uparrow	Selects the entire expression

Frequently Asked Questions

Why does TI Connect™ display a message that Symbolic Math Guide is incompatible with my device?

TI Connect displays this message if your device has an operating system that is not compatible with the App. Symbolic Math Guide requires the Advanced Mathematics operating system software version 2.08 or later.

What are the basic derivatives used in the Symbolic Math Guide App?

$$\frac{d}{dx}(x) \rightarrow 1$$

$$\frac{d}{dx}(x^r) \rightarrow r \cdot x^{(r-1)}$$

$$\frac{d}{dx}(\sqrt{x}) \rightarrow \frac{1}{(2 \cdot \sqrt{x})}$$

$$\frac{d}{dx}\left(\frac{1}{x}\right) \rightarrow \frac{-1}{x^2}$$

$$\frac{d}{dx}\left(\frac{1}{x^r}\right) \rightarrow \frac{-r}{x^{(r+1)}}$$

$$\frac{d}{dx} \tan^{-1}(x) \rightarrow \frac{1}{1+x^2}$$

$$\frac{d}{dx} \cot^{-1}(x) \rightarrow \frac{-1}{1+x^2}$$

$$\frac{d}{dx} \sec^{-1}(x) \rightarrow \frac{1}{x \cdot \sqrt{x^2 - 1}}$$

$$\frac{d}{dx} \csc^{-1}(x) \rightarrow \frac{-1}{x \cdot \sqrt{x^2 - 1}}$$

$$\frac{d}{dx} \sinh(x) \rightarrow \cosh(x)$$

$$\frac{d}{dx} \ln(x) \rightarrow \frac{1}{x}$$

$$\frac{d}{dx} \log(x) \rightarrow \frac{1}{x} \log(e)$$

$$\frac{d}{dx} (e^x) \rightarrow e^x$$

$$\frac{d}{dx} (a^x) \rightarrow \ln(a) \cdot a^x$$

$$\frac{d}{dx} \sin(x) \rightarrow \cos(x)$$

$$\frac{d}{dx} \cos(x) \rightarrow -\sin(x)$$

$$\frac{d}{dx} \tan(x) \rightarrow \sec(x)^2$$

$$\frac{d}{dx} \cot(x) \rightarrow -\csc(x)^2$$

$$\frac{d}{dx} \sec(x) \rightarrow \sec(x) \cdot \tan(x)$$

$$\frac{d}{dx} \cosh(x) \rightarrow \sinh(x)$$

$$\frac{d}{dx} \tanh(x) \rightarrow \operatorname{sech}(x)^2$$

$$\frac{d}{dx} \coth(x) \rightarrow \operatorname{csch}(x)^2$$

$$\frac{d}{dx} \operatorname{sech}(x) \rightarrow -\operatorname{sech}(x) \cdot \tanh(x)$$

$$\frac{d}{dx} \operatorname{csch}(x) \rightarrow -\operatorname{csch}(x) \cdot \coth(x)$$

$$\frac{d}{dx} (\sinh^{-1}) \rightarrow \frac{1}{\sqrt{1+x^2}}$$

$$\frac{d}{dx} \cosh^{-1}(x) \rightarrow \frac{1}{\sqrt{x^2-1}}$$

$$\frac{d}{dx} \tanh^{-1}(x) \rightarrow \frac{1}{1-x^2}$$

$$\frac{d}{dx} \coth^{-1}(x) \rightarrow \frac{1}{1-x^2}$$

$$\frac{d}{dx} \csc(x) \rightarrow -\csc(x) \cdot \cot(x)$$

$$\frac{d}{dx} \operatorname{sech}^{-1}(x) \rightarrow \frac{-1}{x \cdot \sqrt{1-x^2}}$$

$$\frac{d}{dx} \sin^{-1}(x) \rightarrow \frac{1}{\sqrt{1-x^2}}$$

$$\frac{d}{dx} \operatorname{csch}^{-1}(x) \rightarrow \frac{1}{|x| \cdot \sqrt{1+x^2}}$$

$$\frac{d}{dx} \cos^{-1}(x) \rightarrow \frac{-1}{\sqrt{1-x^2}}$$

$$\frac{d}{dx} |x| \rightarrow \sin(x)$$

What are the basic integrals used in the Symbolic Math Guide App?

$$\int (x) dx \rightarrow \frac{1}{2x^2}$$

$$\int \left(\frac{1}{1+x^2} \right) dx \rightarrow \tan^{-1}(x)$$

$$\int (x^r) dx \rightarrow \frac{1}{(r+1) \cdot x^{(r+1)}}$$

$$\int (1+x^2)^{-1} dx \rightarrow \tan^{-1}(x)$$

$$\int (x^{-1}) dx \rightarrow \ln(|x|)$$

$$\int \left(\frac{1}{a^2+x^2} \right) dx \rightarrow \frac{1}{a} \tan^{-1} \frac{x}{a}$$

$$\int \left(\frac{1}{x} \right) dx \rightarrow \ln(|x|)$$

$$\int \left(\frac{1}{a+x^2} \right) dx \rightarrow \frac{1}{\sqrt{a}} \tan^{-1} \frac{x}{\sqrt{a}}$$

$$\int \left(\frac{1}{x^r} \right) dx \rightarrow \frac{-1}{(r-1) \cdot x^{r-1}}$$

$$\int (e)^x dx \rightarrow e^x$$

$$\int (a)^x dx \rightarrow \frac{a^x}{\ln(a)}$$

$$\int \ln(x) dx \rightarrow x \cdot \ln(x) - x$$

$$\int \log(x) dx \rightarrow x \cdot \log(x) - \log(e) \cdot x$$

$$\int \sin(x) dx \rightarrow -\cos(x)$$

$$\int \cos(x) dx \rightarrow \sin(x)$$

$$\int \left(a^2 + x^2 \right)^{-1} dx \rightarrow \frac{1}{a} \tan^{-1} \frac{x}{a}$$

$$\int \left(a + x^2 \right)^{-1} dx \rightarrow \frac{1}{\sqrt{a}} \tan^{-1} \frac{x}{\sqrt{a}}$$

$$\int \left(\frac{1}{x \cdot \sqrt{x^2 - 1}} \right) dx \rightarrow \sec^{-1}(x)$$

$$\int \left(\frac{1}{x \cdot (x^2 - 1)^{\frac{1}{2}}} \right) dx \rightarrow \sec^{-1}(x)$$

$$\int \left(\frac{1}{x \cdot \sqrt{x^2 - a^2}} \right) dx \rightarrow \frac{1}{a} \sec^{-1} \frac{x}{a}$$

$$\int \left(\frac{1}{x \cdot (x^2 - a^2)^{\frac{1}{2}}} \right) dx \rightarrow \frac{1}{a} \sec^{-1} \frac{x}{a}$$

$$\int \left(\frac{1}{x \cdot \sqrt{x^2 - a}} \right) dx \rightarrow \frac{1}{\sqrt{a}} \sec^{-1} \frac{x}{\sqrt{a}}$$

$$\int \tan(x) dx \rightarrow \ln(|\sec(x)|)$$

$$\int \left(\frac{1}{x \cdot (x^2 - a)^{\frac{1}{2}}} \right) dx \rightarrow \frac{1}{\sqrt{a}} \sec^{-1} \frac{x}{\sqrt{a}}$$

$$\int \cot(x) dx \rightarrow \ln(|\sin(x)|)$$

$$\int \sin^{-1}(x) dx \rightarrow x \cdot \sin^{-1}(x) + \sqrt{1-x^2}$$

$$\int \sec(x) dx \rightarrow \ln(|\sec(x) + \tan(x)|)$$

$$\int \cos^{-1}(x) dx \rightarrow x \cdot \cos^{-1}(x) - \left(\sqrt{1-x^2} \right)$$

$$\int \csc(x) dx \rightarrow \ln(|\csc(x) - \cot(x)|)$$

$$\int \tan^{-1}(x) dx \rightarrow x \tan^{-1}(x) - \frac{1}{2} \ln(x^2 + 1)$$

$$\int \sec(x)^2 dx \rightarrow \tan(x)$$

$$\int \cot^{-1}(x) dx \rightarrow x \cdot \cot^{-1}(x) + \frac{1}{2} \ln(x^2 + 1)$$

$$\int \csc(x)^2 dx \rightarrow -\cot(x)$$

$$\int \sec^{-1}(x) dx \rightarrow x \cdot \sec^{-1}(x) - \ln\left(x + \sqrt{x^2 - 1}\right)$$

$$\int \sec(x) \cdot \tan(x) dx \rightarrow \sec(x)$$

$$\int \csc^{-1}(x) dx \rightarrow x \cdot \csc^{-1}(x) + \ln\left(x + \sqrt{x^2 - 1}\right)$$

$$\int \csc(x) \cdot \cot(x) dx \rightarrow -\csc(x)$$

$$\int \sinh(x) dx \rightarrow \cosh(x)$$

$$\int \left(\frac{1}{\sqrt{1-x^2}} \right) dx \rightarrow \sin^{-1}(x)$$

$$\int \cosh(x) dx \rightarrow \sinh(x)$$

$$\int \left(\frac{1}{(1-x^2)^{\frac{1}{2}}} \right) dx \rightarrow \sin^{-1}(x)$$

$$\int (1-x^2)^{-\frac{1}{2}} dx \rightarrow \sin^{-1}(x)$$

$$\int \left(\frac{1}{\sqrt{a^2-x^2}} \right) dx \rightarrow \sin^{-1} \frac{x}{a}$$

$$\int \left(\frac{1}{\sqrt{a^2-x^2}} \right) dx \rightarrow \sin^{-1} \frac{x}{\sqrt{a}}$$

$$\int \frac{1}{(a^2-x^2)^{\frac{1}{2}}} dx \rightarrow \sin^{-1} \frac{x}{a}$$

$$\int \frac{1}{(a-x^2)^{\frac{1}{2}}} dx \rightarrow \sin^{-1} \frac{x}{\sqrt{a}}$$

$$\int (a^2-x^2)^{-\frac{1}{2}} dx \rightarrow \sin^{-1} \frac{x}{a}$$

$$\int \tanh(x) dx \rightarrow \ln(\cosh(x))$$

$$\int \coth(x) dx \rightarrow \ln(|\sinh(x)|)$$

$$\int \operatorname{sech}(x) dx \rightarrow \tan^{-1}(\sinh(x))$$

$$\int \operatorname{csch}(x) dx \rightarrow \ln\left(\left|\tanh \frac{x}{2}\right|\right)$$

$$\int \operatorname{sech}(x)^2 dx \rightarrow \tanh(x)$$

$$\int \operatorname{csch}(x)^2 dx \rightarrow -\operatorname{coth}(x)$$

$$\int \operatorname{sech}(x) \cdot \tanh(x) dx \rightarrow -\operatorname{sech}(x)$$

$$\int (a - x^2)^{-\frac{1}{2}} dx \rightarrow \sin^{-1} \frac{x}{\sqrt{a}}$$

$$\int \operatorname{csch}(x) \cdot \operatorname{coth}(x) dx \rightarrow -\operatorname{csch}(x)$$

Why don't the usual equation-solving transformations appear on the F4 menu?

When the problem was created, a problem type from the Simplify category was probably used instead of a problem type from the Solve category.

The Compute Derivative problem type doesn't allow a third argument for $d(\text{expression}, \text{variable})$. How can I compute higher order derivatives?

You can enter a $d(\dots, \dots)$ in the first argument of $d(\dots, \dots)$ as deeply nested as you wish. For example, to compute the third derivative of x^3 with respect to x , the entire entry is $d(d(d(x^3, x), x), x)$.

Pressing **ENTER** seems to accomplish different things. Can you explain?

Pressing **ENTER** is a shortcut to "clean up" the equation or expression currently displayed. "Cleaning up" means:

- Performing arithmetic or applying the 0 and 1 identity for all **Simplify** problem types.

- Simplifying the expression for all **Solve** problem types and for **Compute: Derivatives**, **Compute: Indefinite Integrals**, and **Other: Identity** problem types.

When the TIME TO THINK mode is on, the application pauses to let you consider what will happen when you apply the selected transformation. You must press **ENTER** after you select each transformation to apply that transformation.

What is the Domain of Definition (F5** Info)?**

It is the set of all finite real values of the variables in an expression for which the expression and all of its sub-expressions are finite and real. For example, the domain of definition for

$(\sqrt{x} + \ln(y) + \sin^{-1}(z) + \frac{1}{t})$ is $t \neq 0$, $x \geq 0$, $y > 0$, $z \geq -1$ and $z \leq 1$.

Why does applying “divide like factors” to $\frac{x^2}{x}$ produce $x \mid x \neq 0$, whereas applying “divide like factors” to $\frac{x}{x^2}$ produces $\frac{1}{x}$, with no constraint?

The domain of definition for $\frac{x^2}{x}$ is $x \neq 0$, whereas the domain of definition for x is all finite real values of x . Therefore, the constraint is adjoined to x to preserve the domain of definition. In contrast, $\frac{x}{x^2}$ and $\frac{1}{x}$ both have the same domain of definition: $x \neq 0$. Therefore, it isn't necessary to adjoin a constraint on $\frac{1}{x}$ to avoid enlarging the domain of definition. You can always use **[F5] 1: Info** and then select **3: Domain of Definition** to compute the complete domain of definition whenever you wish.

Why does applying “ $0 \cdot A \rightarrow 0$ ” to $0 \cdot \sqrt{x}$ produce $0 \mid x \geq 0$, whereas applying “ $0 + A \rightarrow A$ ” to $0 + \sqrt{x}$ produces \sqrt{x} with no constraint?

The domain of definition for $0 \cdot \sqrt{x}$ is $x \geq 0$, whereas the domain of definition for 0 is all finite real values of x . Therefore, the constraint is adjoined to 0 to preserve the domain of definition. In contrast, $0 + (\sqrt{x^2})$ and \sqrt{x} both have the same domain of definition: $x \geq 0$.

Therefore, it isn't necessary to adjoin a constraint to \sqrt{x} to avoid enlarging the domain of definition. You can always use [F5](#) 1: Info and then select 3: Domain of Definition to compute the complete domain of definition whenever you wish.

Why does applying “ $1^A \rightarrow 1$ ” to $1^{\ln(x)}$ produce $1 \mid x > 0$, whereas applying “ $1 \cdot A \rightarrow A$ ” to $1 \cdot \ln(x)$ produce $\ln(x)$ with no constraint?

The domain of definition for $1^{\ln(x)}$ is $x > 0$, whereas the domain of definition for 1 is all finite real values of x . Therefore, the constraint is adjoined to 1 to preserve the domain of definition. In contrast, $1 \cdot \ln(x)$ and $\ln(x)$ both have the same domain of definition: $x > 0$. Therefore, it isn't necessary to adjoin a constraint to $\ln(x)$ to avoid enlarging the domain of definition. You can always use [F5](#) 1: Info and then select 3: Domain of Definition to compute the complete domain of definition whenever you wish.

Why doesn't the home screen generate domain preservation constraints such as when transforming $0 \cdot \sqrt{x}$ to 0 ?

On the home screen $|$ is used only for input, and REAL mode means only that the *resulting expressions* must be real. In contrast, Symbolic Math Guide also uses $|$ for output to constrain variables so that *all sub-expressions* are also real.

Why doesn't the home screen generate domain preservation constraints such as when transforming x^0 to 1 ?

In keeping with their use in limits and improper integrals, infinite magnitude results such as $+\infty$ and $-\infty$ are considered to be *defined* on the home screen. In contrast, $+\infty$ and $-\infty$ are considered to be *undefined* in Symbolic Math Guide where there are no limit or improper integral problems.

For problem categories Simplify, Log & Exponential, and above, why does $\boxed{F4}$ sometimes offer $\ln(A^U) \rightarrow U \cdot \ln(|A|)$?

The absolute value is needed to preserve equivalence when U is even or has an even reduced numerator and A might be negative.

Why does the $\boxed{F4}$ menu sometimes offer $(A^U)^V \rightarrow A^{U \cdot V}$ but other times offer $(A^U)^V \rightarrow |A|^{U \cdot V}$?

The absolute value is needed to preserve equivalence when U is even or has an even reduced numerator and A might be negative.

Why does the $\boxed{F4}$ menu offer $(-A)^B \rightarrow A^B$ for examples such as $(-x)^2$, and offer $(-A)^B \rightarrow -A^B$ for examples such as $(-x)^3$, but offer neither for examples such as $(-x)^y$ and $(-x)^{1/2}$?

The first transformation is valid if B is odd or a reduced ratio of two odd integers. The second transformation is valid if B is even or a reduced ratio of an even over an odd integer. Neither is valid if B is a reduced ratio of an odd over an even integer. For example, $(-(-1))^{1/2}$ is 1, but $(-1)^{1/2}$ and $-(-1)^{1/2}$ are both non-real. Symbolic Math Guide must know enough about the specific B to determine which of these two transformations is applicable, if any. For example, adjoin “ $|x > 0$ ” to your original problem input. Alternatively, use $\boxed{F5}$ 3: Rewrite to force the transformation you desire.

Why does the $\boxed{F4}$ menu sometimes offer $(A \cdot B)^U \rightarrow A^U \cdot B^U$, but other times offer $(A \cdot B)^U \rightarrow |A|^U \cdot |B|^U$?

The absolute values are needed to preserve equivalence when U is even or has an even reduced numerator and A and B are both negative.

Why does the $\boxed{F4}$ menu sometimes offer $A/B^U \rightarrow A^U/B^U$, but other times offer $(A/B)^U \rightarrow |A|^U/|B|^U$?

The absolute values are needed to preserve equivalence when U is even or has an even reduced numerator and A and B are both negative.

Why does the $\boxed{F4}$ menu offer $\tan^{-1}(\tan(A)) \rightarrow A$ for examples such as $\tan^{-1}(\tan(\pi/3))$ but not for examples such as $\tan^{-1}(\tan(y))$?

This transformation is valid in Symbolic Math Guide only if $A > -\pi/2$ and $A < \pi/2$. The application must know enough about the specific A to determine if the transformation is applicable.

Texas Instruments (TI) Support and Service

For General Information

Home Page: education.ti.com

KnowledgeBase and
E-mail Inquiries: education.ti.com/support

Phone: (800) TI-CARES; (800) 842-2737
For U.S., Canada, Mexico, Puerto
Rico, and Virgin Islands only

International Information: education.ti.com/support
(Click the International Information
link.)

For Technical Support

KnowledgeBase and
Support by E-mail: education.ti.com/support

Phone (not toll-free): (972) 917-8324

For Product (hardware) Service

Customers in the U.S., Canada, Mexico, Puerto Rico and Virgin Islands: Always contact TI Customer Support before returning a product for service.

All other customers: Refer to the leaflet enclosed with this product (hardware) or contact your local TI retailer/distributor.

TEXAS INSTRUMENTS LICENSE AGREEMENT

BY INSTALLING THIS SOFTWARE YOU AGREE TO ABIDE BY THE FOLLOWING PROVISIONS.

1. **LICENSE:** Texas Instruments Incorporated (“TI”) grants you a license to use and copy the software program(s) (“Licensed Materials”) contained on this diskette/CD/web site. You, and any subsequent user, may only use the Licensed Materials on Texas Instruments devices.
2. **RESTRICTIONS:** You may not reverse-assemble or reverse-compile the Licensed Materials. You may not sell, rent, or lease copies that you make.
3. **COPYRIGHT:** The Licensed Materials and any accompanying documentation are copyrighted. If you make copies, do not delete the copyright notice, trademark, or protective notices from the copies.
4. **WARRANTY:** TI does not warrant that the Licensed Materials or documentation will be free from errors or that they will meet your specific requirements. **THE LICENSED MATERIALS ARE PROVIDED “AS IS” TO YOU OR ANY SUBSEQUENT USER.**
5. **LIMITATIONS:** TI makes no warranty or condition, either express or implied, including but not limited to any implied warranties of merchantability and fitness for a particular purpose, regarding the Licensed Materials.

IN NO EVENT SHALL TI OR ITS SUPPLIERS BE LIABLE FOR ANY INDIRECT, INCIDENTAL, OR CONSEQUENTIAL DAMAGES, LOSS OF PROFITS, LOSS OF USE OR DATA, OR INTERRUPTION OF BUSINESS, WHETHER THE ALLEGED DAMAGES ARE LABELED IN TORT, CONTRACT, OR INDEMNITY.

SOME STATES OR JURISDICTIONS DO NOT ALLOW THE EXCLUSION OR LIMITATION OF INCIDENTAL OR CONSEQUENTIAL DAMAGES, SO THE ABOVE LIMITATION MAY NOT APPLY.

Page Reference

This PDF document contains electronic bookmarks designed for easy on-screen navigation. If you decide to print this document, please use the page numbers below to find specific topics.

Important Information.....	2
What is Symbolic Math Guide?.....	3
What You Will Need	6
Where to Find Installation Instructions	7
Getting Help.....	7
Keystroke Differences.....	8
Memory Requirements.....	12
Starting and Quitting Symbolic Math Guide.....	13
Getting Started	15
Creating Problem Sets.....	31
Navigating within a Problem Set	34
Learning with Problem Sets	36
Selecting Part of an Expression	40
Defining a Function.....	53
Substituting, Back-substituting, Rewriting, and Verifying the Solutions of Equations.....	55
Domain of Definition and Domain Preservation Constraints	60

Shortcuts – Scrolling Mode	63
Shortcuts – Sub-expression Selection Mode	67
Frequently Asked Questions	68
Texas Instruments (TI) Support and Service	81
TEXAS INSTRUMENTS LICENSE AGREEMENT	83